

NI *Nailor*[®] *Industries Inc.*



TERMINAL UNITS

For the most up to date catalog information go to

www.nailor.com

SOUND SOLUTIONS

NAILOR'S "STEALTH™" FAN POWERED TERMINAL UNIT

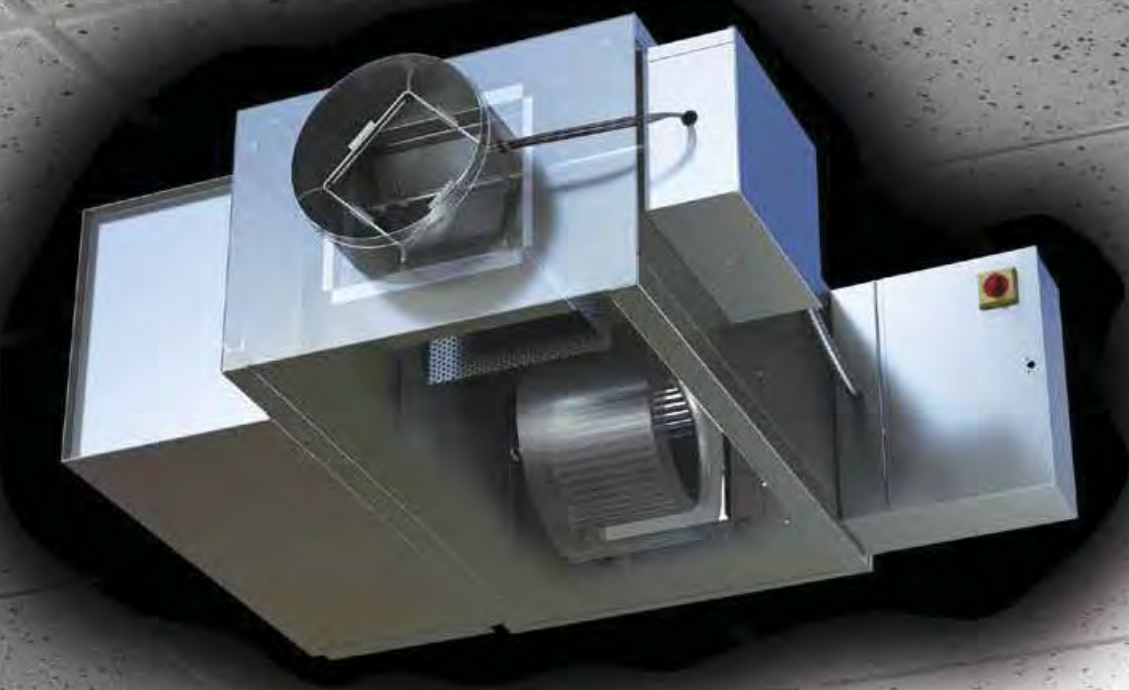

NAILOR IS AHRI CERTIFIED AND ETL LISTED



NAILOR IS 100% INDEPENDENTLY CERTIFIED

• Every size of every model of Nailor Terminal Units has been tested at every catalogued operating point and certified by Energistics Laboratory



NAILOR, THE FIRST TO OFFER ECM MOTOR TECHNOLOGY

- Factory pre-set air volume capability
- 67% typical energy savings compared to PSC motors
- Pressure independent fan operation
- LED for visual indication of air volume
- Field adjustable fan air volume controller
- Remote fan air volume adjustment capability with analog voltage input from BMS
- Large turn down ratios mean more flexibility for tenant changes

NAILOR UNITS ARE SMALL

- Smallest footprint in the industry
- Easy to handle
- Easy to hang

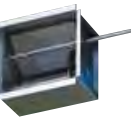

DAMPER

- Opposed blade damper with 45° closure
- Good linearity with constant rate of change for BTUH to space



NAILOR ELECTRIC HEAT OPTION

- High efficiency arrowhead insulators eliminate glow and extend element life
- Manufactured in-house by Nailor
- Removable element rack



NAILOR HOT WATER HEAT OPTION

- Access panels that expose both faces of coil for cleaning and inspection
- Encased headers and return bends
 - No heat loss in heating condition, no heat gain in cooling condition

JOB SITE FLEXIBILITY

- Unit may be flipped over for right or left hand orientation



- Optional FN2 90° discharge enclosure helps compliance with NEC clearance requirements



MULTI-POINT DIAMOND FLOW INLET SENSOR

- +/-5% accuracy even with hard 90° elbow at the inlet
- Durable aluminum construction
- Manufactured by Nailor

www.nailor.com

HOUSTON, TEXAS Tel: (281) 590-1172 LAS VEGAS, NEVADA Tel: (702) 648-5400 TORONTO, CANADA Tel: (416) 744-3300 CALGARY, CANADA Tel: (403) 279-8619 THETFORD, ENGLAND Tel: (01284) 701356

Nailor[®]
Industries Inc.

GENERAL PRODUCT OVERVIEW

O

SINGLE DUCT TERMINAL UNITS

A

DUAL DUCT TERMINAL UNITS

B

FAN POWERED TERMINAL UNITS

C

RETROFIT TERMINAL UNITS

D

BYPASS TERMINAL UNITS

E

CONTROLS

F

SUGGESTED SPECIFICATIONS

G

ENGINEERING GUIDE & INDEX

H

Catalog July 2018. Printed in U.S.A.

Copyright© 2018 by Nailor Industries Inc. All rights reserved. No part of this catalog may be reproduced or transmitted in any form or by any means, electronic or mechanical, including photocopying and recording, or by any information storage and retrieval system without permission in writing from Nailor Industries Inc.

In this catalog the terms of "Nailor Industries Inc.", "Nailor", "Nailor Industries" or "Nailor International Group" are synonymous and may be interchangeable for context or clarity.

Nailor Industries Inc. pursues a policy of continuous product development and we therefore reserve the right to change any of the information in this publication without notice.

Contact your Nailor representative to verify current product details.

Nailor International Inc.

Today, we are proud that the Nailor International Group of manufacturing companies are recognized worldwide in the HVAC industry for our comprehensive product offering. However, many may not know that the group had humble beginnings.

The company commenced operations in 1971 at a small facility in Toronto, Canada manufacturing a single air control device (the curtain fire damper). Michael T. Nailor (President and CEO) started with the founding principle that the company would be customer focused and service orientated, dedicated to fulfilling the need for high quality, competitively priced products, delivered to our customers on schedule. That attitude and the values instilled by Mike in all Nailor employees, still applies today and as a result the company has been rewarded with a continually increasing demand for our products.

Our track record is one of technical leadership and innovation, pioneering the development of new products that exceed industry standard design and performance specifications. Just one example is the commercial introduction in 1995 of the EC motor (ECM) in fan powered terminal units, providing substantial energy savings and which has now become the industry standard. This was followed in 2005 with the introduction of a new line of innovative commercial fan coil units, the first available with variable air volume EPIC Fan Technology® and ECM to provide increased occupant comfort as well as energy savings. We felt the significance of this new development at the time, should also herald a new brand name – Engineered Comfort.

In order to benefit the industry, continue to innovate and stay ahead, Nailor is committed to actively participating on technical committees and in the standards writing process at ASHRAE, AHRI and AMCA for our product lines.

Today, Nailor International Inc. is still a privately held company with Group Headquarters in Houston, Texas. The company now has manufacturing plants totaling one million square feet strategically located in three countries with an international distribution network of representatives working together to not only meet, but exceed the expectations of clients, engineers and customers around the world.

"Complete Air Control and Distribution Solutions."



www.nailor.com

Terminal Units, Air Distribution and
Air Control Products
(USA, Canada and Worldwide)



www.engineered-comfort.com

Commercial Fan Coil Units
(USA and Canada)



www.klean-aire.com

Filter Housings for Commercial and
Industrial HVAC Filtration Systems
(USA and Canada)



www.thermal-corp.com

Quality Custom Air Handling Equipment
and Blower Coils since 1945
(USA and Canada)



www.advancedair.co.uk

Commercial Fan Coils and Terminal Units,
Air Distribution and Air Control Products
(UK and Europe)

U.S.A. • CANADA • U.K.

GENERAL PRODUCT OVERVIEW

Single Duct
Dual Duct
Fan Powered
Retrofit
Bypass

Terminal Units

TABLE OF CONTENTS

	Page No.
Nailor's Comprehensive Product Line	03
AHRI And Independent Laboratory Certification	010
Common Components	011
Controls	013

NAILOR'S COMPREHENSIVE PRODUCT LINE

Single Duct Terminal Units

3000 Series - Supply

Designed for cooling only, cooling with reheat, heating only or heat/cool changeover applications.

- Available in 11 sizes. 0 – 8330 cfm (0 – 3931 l/s).
- Unit sizes 4 through 16 – up to 3725 cfm (1758 l/s), are a maximum overall height of only 12 1/2" (318). The low profile design is advantageous where ceiling space is restricted.
- Unit sizes 12 through 16 feature flat oval inlet collars. Unit size 24 x 16 features rectangular inlet collar.
- High performance inclined opposed blade damper.
- Diamond Flow multi-point averaging sensor on pressure independent models.
- Pressure dependent or independent airflow control.
- Digital, analog electronic, electric or pneumatic control.
- Options include attenuators, hot water coils or integral electric coils for reheat, and various IAQ linings.

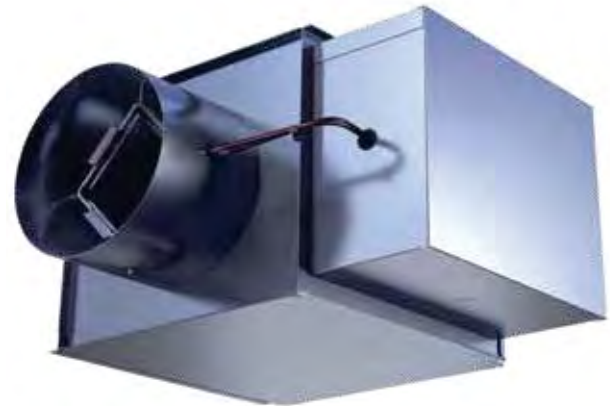

Model 3001

Models 3001, 30RW, 30RE

See Page A6

3000Q Series - Quiet

3000Q Series units are designed to operate at exceptionally quiet levels in noise sensitive applications such as libraries, studios, performance halls and classrooms. Compatible with applications requiring cooling, cooling with reheat, heating only or heat/cool changeover applications.

- 3000Q Quiet Series with factory mounted dissipative silencer.
- Choice of terminal liners with 3 different silencer acoustic media options.
- IAQ liners available throughout.
- Hot water and electric coil options.
- Performance data for close coupled device.
- Shares components and features of the 3000 Series units.
- Available in 11 sizes. 0 – 8330 cfm (0 – 3931 l/s).

Models 3001Q, 30RWQ, 30REQ

See Page A22

30HQ Series - Hospital Grade Quiet

The 30HQ Series terminal units are uniquely designed for use in hospitals. Using innovative construction methods coupled with healthcare focused options, the 30HQ offers a quiet, simplified maintenance terminal that meets the demands of hospital applications.

- 30HQ Hospital Grade version with factory mounted dissipative silencer.
- IAQ compatible liner.
- Hot water and electric coil options.
- Durable, cleanable surfaces.
- Performance data for close coupled device.
- Internally lined dissipative silencer eliminates need to externally insulate unit.
- Available in 11 sizes. 0 – 8330 cfm (0 – 3931 l/s).

Models 30HQ, 30HQW, 30HQE

See Page A32



Model 3001Q

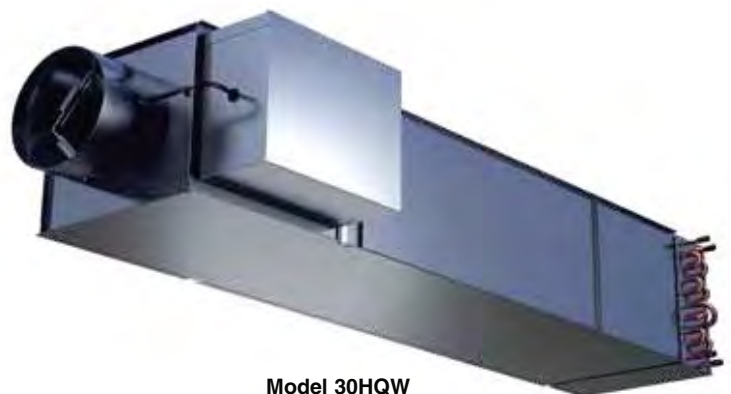

Model 30HQW

Single Duct Terminal Units

3000 Series – Exhaust

30X Series modulate exhaust flow from an occupied space in constant volume or variable volume applications. They are ideal for environments where IAQ is important such as laboratory, health care and pharmaceutical applications.

- Venturi Valve inlet reduces pressure drop.
- Available in 11 unit sizes to handle from 0 – 8575 cfm (0 – 4047 l/s).
- Removable flow sensor to aid in meeting sanitation/ maintenance requirements.
- Optional Inlet attenuator.
- IAQ liners available.

Model 30X

See Page A54



Model 30X

30HGX Series – Hospital Grade Exhaust

Sharing many components with the 30X Series, the 30HGX hospital grade exhaust series improves the basic design by adding a dissipative silencer to the inlet and making removable flow sensors with access doors as standard. Internal liners are specifically selected to offer durable cleanable surfaces with good sound attenuation performance. Although designed around the needs of hospitals, the 30HGX Series can be used in a wide variety of Critical Environment applications.

- Standard inlet dissipative silencer.
- Standard access door.
- Easily removable flow sensor.
- IAQ liners as standard.
- 11 sizes to handle small to large flow ranges.

Models 30HGX

See Page A68



30HGX

Dual Duct Terminal Units

3200 Series

Designed for control of hot or neutral and cold air. Variable volume with or without mixing or constant volume applications.

- Available in three models with airflow ranging from 0 – 4525 cfm (0 – 2135 l/s).
- Extra low leakage opposed blade dampers control cold and hot decks.
- Diamond Flow multi-point averaging sensor.
- Mixing models include integral attenuator with internal mixing baffles to minimize downstream stratification.
- Pressure independent airflow control.
- Digital, analog electronic or pneumatic control.
- Options include total air discharge sensing and various IAQ linings.

Model 3210

See Page B4

For non-mixing applications.

Model 3230

See Page B11

Better than 1:12 mixing.
Economical compact design.
Integral mixing attenuator.

Model 3240 "BlendMaster™"

See Page B18

Industry leading performance provides 1:30 mixing.
Integral mixing attenuator.

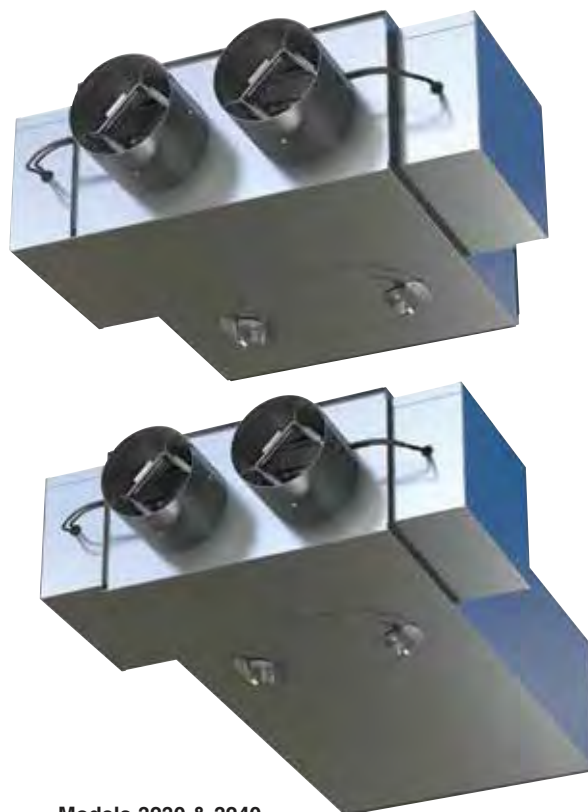

Models 3230 & 3240

Series Flow (Constant or Variable Volume)

Fan Powered Chilled Water Terminal Units

33SZ Series

- Designed for use with DOAS AHU's.
- Sensible cooling coil on the induced air inlet handles zone sensible load.
- Ultra-high efficiency ECM/EPIC Fan Technology®.
- Galvanized drip pan integral to sensible coil.
- Standard and low profile designs with various IAQ liner options.
- Diamond Flow multi-point averaging sensor.
- 90° degree or remote mount line voltage enclosure options available to help with NEC compliance.
- Available in 3 unit sizes with 250 – 2000 cfm (118 – 944 l/s) fan airflow range, each with various primary air inlet size options for optimum flexibility.
- Options include hot water or electric coil for supplementary heat.
- MERV filters and ducted filter rack options available.
- "Stealth™" induced air silencer option.



Model 33SZ

Models 33SZ, 33SZE, 33SZW

See Page C14

Series Flow (Constant or Variable Volume) Fan Powered Terminal Units

35S Series

- Quiet constant fan operation.
- Available in 7 fan sizes, each with various primary air inlet size options for optimum design flexibility. 100 – 3700 cfm (47 – 1746 l/s) fan airflow range.
- High performance inclined opposed blade primary air damper.
- Diamond Flow multi-point averaging sensor.
- Custom high efficiency PSC motor/blower design.
- Solid state fan speed controller.
- Pressure independent airflow control.
- Digital, analog electronic or pneumatic control.
- Available Q option induced air attenuator.
- Options include hot water coils or integral electric coils for supplementary heat.
- Various IAQ linings.
- Available with ultra-high efficiency ECM/EPIC Fan Technology®.
- Available 90° or remote mounted line voltage enclosure.



Model 35SW

Models 35S, 35SW, 35SE

See Page C35

Super Quiet "Stealth™" Series Flow (Constant or Variable Volume) Fan Powered Terminal Units

35SST "Stealth™" Series

- Super quiet premium design. Constant fan operation.
- "Stealth™" design technology.
- Available in 7 fan sizes, each with various primary air inlet size options for optimum design flexibility. 100 – 3700 cfm (47 – 1746 l/s) fan airflow range.
- High performance inclined opposed blade primary air damper.
- Diamond Flow multi-point averaging sensor.
- Custom high efficiency PSC motor/blower design.
- Solid state fan speed controller.
- Pressure independent airflow control.
- Digital, analog electronic or pneumatic control.
- Options include hot water coils or integral electric coils for supplementary heat.
- Various IAQ linings.
- Available with ultra-high efficiency ECM/EPIC Fan Technology®.
- Available 90° or remote mounted line voltage enclosure.

Models 35SST, 35SWST, 35SEST See Page C49



Model 35SEST

Series Flow (Constant or Variable Volume) Fan Powered Terminal Units With Outside Air Inlets (OAI)

35S and 35SST Series with OAI

Incorporates the features and benefits found in the standard fan powered terminal unit design with a dual duct inlet configuration.

- Separate outside air ventilation inlet damper is provided in addition to the main primary air valve. This second valve is configured for constant volume operation and helps ensure that minimum outside air ventilation requirements are maintained at all times independent of the main AHU operation.
- Available with ultra-high efficiency ECM/EPIC Fan Technology®.

Models 35S-OAI, 35SW-OAI, 35SE-OAI, 35SST-OAI, 35SWST-OAI, 35SEST-OAI See Page C62

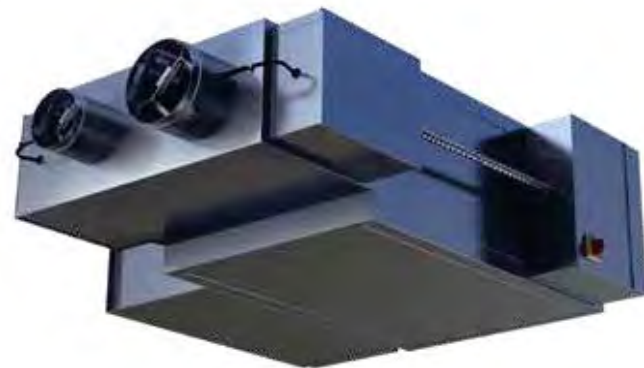

Model 35SST with OAI option

Series Flow (Constant Volume) Fan Powered Pressurization Terminal Units (CVP)

35S Series with CVP

- Designed especially for critical environments such as hospital isolation rooms and bio-tech applications.
- Utilizes Nailor's ECM/EPIC Fan Technology® with an ultra-high efficiency Brushless DC motor to provide a pressure independent assembly.
- Maintains precise volume control and compensates for changes in external static pressure as encountered across a HEPA filter.
- Up to 3000 cfm (1416 l/s) at 1" w.g. (250 Pa).

Models 35S-CVP, 35SW-CVP, 35SE-CVP See Page C69



Model 35SW-CVP

Low Profile Series Flow (Constant or Variable Volume) Fan Powered Terminal Units

37S Series

- Only 11" (279) in height.
- Designed especially for applications where ceiling plenum space is restricted.
- Quiet constant fan operation.
- Available in 4 fan sizes, each with various primary air inlet size options for design flexibility. 100 – 2100 cfm (47 – 991 l/s) fan airflow range.
- High performance inclined opposed blade primary air damper.
- Diamond Flow multi-point averaging sensor.
- Custom high efficiency PSC motor/blower design.
- Solid state fan speed controller.
- Pressure independent airflow control.
- Digital, analog electronic or pneumatic control.
- Options include hot water coils or integral electric coils for supplementary heat.



Model 37SE

- Various IAQ linings.
- Available with ultra-high efficiency ECM/EPIC Fan Technology®.
- Available 90° line voltage enclosure (Standard on 37SE).

Models 37S, 37SW, 37SE

See Page C80

Low Profile Series Flow (Constant or Variable Volume) Fan Powered Terminal Units

37SST "Stealth™" Series

Incorporates all of the features and benefits found in the 37S standard low profile terminal unit plus the following:

- Super quiet premium design.
- "Stealth™" design technology.
- Available with ultra-high efficiency ECM/EPIC Fan Technology®.

Models 37SST, 37SWST, 37SEST

See Page C91



Model 37SWST

Parallel Flow (Variable Air Volume) Fan Powered Terminal Units

35N Series

- Quiet intermittent fan operation.
- Pressure dependent or independent airflow control.
- Available in four fan sizes, each with various primary air inlet size options for optimum design flexibility. 150 – 2100 cfm (70 – 990 l/s) fan airflow range.
- Primary airflow range from 0 to 4525 cfm (0 – 2135 l/s).
- Diamond Flow multi-point averaging sensor on pressure independent models.
- Custom high efficiency PSC motor/blower design.
- Solid state fan speed controller.
- Digital, analog electronic or pneumatic control.
- Options include hot water coils or integral electric coils for supplementary heat.
- Various IAQ linings.
- Induced air Inlet Attenuator Q option.
- Available with ultra-high efficiency ECM/EPIC Fan Technology®.



Model 35NW

Models 35N, 35NW, 35NE

See Page C105

Low Profile Parallel Flow (Variable Air Volume) Fan Powered Terminal Units

37N Series

- Quiet intermittent fan operation.
- Pressure dependent or independent airflow control.
- Available in three fan sizes, each with various primary air inlet size options. 150 – 1175 cfm (70 – 554 l/s) fan airflow range.
- Primary airflow range from 0 to 2950 cfm (0 – 1390 l/s).
- Options include hot water coils or integral electric coils for supplementary heat.
- Ultra-high efficiency ECM/EPIC Fan Technology®.
- Designed for applications where ceiling plenum space is restricted.



Model 37NW

Models 37N, 37NW, 37NE

See Page C119



Model 36VRR

Round Duct External Retrofit Terminal Units

36VRR Series

Convert existing constant volume systems or old system powered mechanical regulator terminals to energy efficient variable volume operation.

- Available in ten sizes to suit and install simply in round ductwork. 0 – 4525 cfm (0 – 2135 l/s).
- Various configurations custom fabricated to suit individual application.
- Pressure dependent or independent airflow control.
- Diamond flow multi-point averaging flow sensor on pressure independent models.
- Digital, analog electronic or pneumatic control.

Model 36VRR

See Page D5

Rectangular Slide-in Retrofit Terminal Units

36VRS Series

Convert existing constant volume systems to energy efficient variable volume operation.

- Available in 15 valve sizes to handle a large range of air volumes. 0 – 15000 cfm (0 – 7071 l/s).
- Custom fabricated to suit any duct size from 5" x 5" (127 x 127) up to 52" x 26" (1321 x 660).
- Diamond Flow multi-point averaging sensor.
- Pressure independent airflow control.
- Digital, analog electronic or pneumatic control.

Model 36VRS

See Page D10



Model 36VRS

Internal Retrofit Terminal Units

36VR Series

Designed to replace the mechanical regulators in old system powered terminal units in order to substantially lower the operational static pressure requirement. The air valves include a damper, flow sensor and actuator and make use of state-of-the-art controls in order to reduce operating cost.

- Custom built on a specific project basis.
- Variable or constant volume pressure independent airflow control.
- Diamond Flow multi-point averaging flow sensor.
- Models available to retrofit most brand name terminal units.
- Digital, analog electronic or pneumatic control.

Model 36VR

Contact your Nailor Sales Rep.

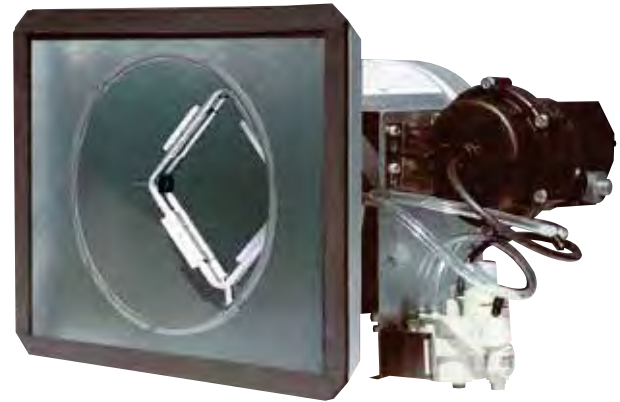

Model 36VRBS



Model 36FMSD

Round Duct Flow Measuring Stations

Model 36FMI • Insert Type

Model 36FMIS • Sleeve Type

Model 36FMSD • With Balancing Damper

Designed as a basic Flow Measuring station for applications where manual balancing is required.

- Includes balancing damper with hand locking quadrant.
- Inlet & Outlet Stiffening beads provide for a method of securing flexible duct.
- Ideal for use with displacement ventilation diffusers.

Model 36FMSD

See Page D14

Bypass Terminal Units

3400 Series

Designed to provide variable air volume supply when used with constant volume fan low pressure packaged air handling systems or roof-top air conditioning units. Excess air is diverted through a bypass opening and into the system return.

- Unique low torque flow diverter valve.
- Simple, inexpensive VAV control.
- Pressure dependent operation.
- Analog electronic or pneumatic control.
- Options include hot water and electric coils for reheat.

Models 3400, 34RW, 34RE

See Page E3



Model 3400

AHRI CERTIFICATION

Nailor is a participating company in the Air Conditioning, Heating and Refrigeration Institute's 880 certification program for variable air volume terminal units. Nailor has completed and received AHRI certification for our complete line of Single Duct, Dual Duct, Fan Powered and Bypass Terminal Units presented in this catalog.

To comply with AHRI Standard 880, manufacturers must rate their products at standard rating conditions as specified by the standard. This permits direct comparison between manufacturers. In addition to standard ratings, Nailor also publishes application ratings. These application ratings are based upon tests conducted in accordance with the standard but at other conditions as well in order to provide the design engineer with a wider range of data from which to make his selection.

Participation in the AHRI program provides assurance that manufacturers' equipment will meet the claimed performance ratings. Compliance with AHRI Standard 880 by participants in the certification program is assured by regular testing of random samples by an independent laboratory.



A Participating Corporation in the AHRI Standard 880 Certification program.

INDEPENDENT LABORATORY CERTIFICATION

Although AHRI Certification, as explained above, provides some assurance of product performance, the program only verifies a single standard rating condition (certification rating point) for each terminal size. This is for valid logistical reasons. However, the correlation of the AHRI rating points with the comprehensive application data is sometimes difficult to reconcile in some manufacturers catalogs.

In order to provide assurance and complete credibility to the engineering community, Nailor tests its products at Energistics Laboratory; one of the foremost research, development and test facilities in North America.



COMMON COMPONENTS

Diamond Flow Sensor

The Nailor Diamond Flow is a multi-point airflow sensor that is designed to provide an averaged and accurate flow signal for use with pressure independent controls.

Accuracy

Conventional airflow sensors function best under ideal inlet conditions. Space constraints, structural components and mechanical system machinery often influence inlet conditions, in many instances, creating less than ideal entering conditions. Without the several lengths of duct needed for ideal conditions, the air profile moving across the sensor can become distorted or turbulent. As a result, the non-uniform inlet condition provides an inaccurate airflow measurement.

The Diamond Flow is constructed of aluminum (stainless steel is optional) to ensure longevity and strength. Each sensor has a minimum of four pick-up points on each side which sample airflow in each quadrant of the inlet. Those readings are then averaged, providing an output signal available to a controller. The 'Diamond Flow' has a maximum error envelope of +/- 5%. Resulting flow measurements are therefore accurate when used within normal practices and often without ideal inlet conditions.

Signal Amplification

Another Diamond Flow sensor advantage lies in the approximate 2.5 average amplification factor of the velocity pressure signal (ΔP) sent to the controller. By amplifying this signal 2.5 times, accuracy is enhanced primarily during low airflow conditions. Inside pneumatic reset controllers, the static pressure signal is subtracted from the total pressure

signal by piping these pressures to opposite sides of the diaphragm. The combined diaphragm and spring assembly have a mass equivalent to about .03" w.g. (7.5 Pa). This mass defines the dead band and the minimum ΔP setting. By amplifying the velocity signal, the controller is tricked into a lower minimum capability and a narrower dead band. The same advantage is realized with digital and analog electronic controls utilizing a flow sensor and transducer. Low flow sensitivity is increased and lower settings can be held. Exact control at minimum settings is crucial in maintaining good IAQ design practices.

Minimal Intrusion

The sleek design of the sensor causes minimal disturbance to the airstream. Therefore, compared with other bulkier sensor designs, it produces a minimal pressure drop increase across the terminal unit damper, reducing the inlet static pressure requirement and increasing energy efficiency, while at the same time producing negligible sensor generated noise.

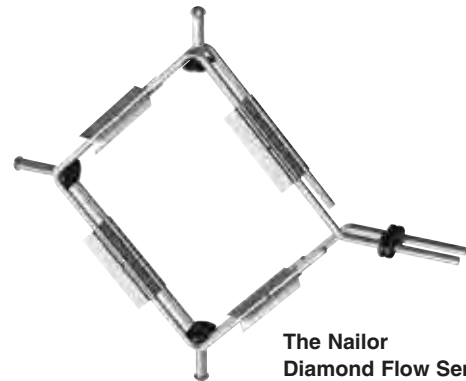

The Nailor Diamond Flow Sensor



Nailor Inclined Opposed Blade Damper

Opposed Blade Damper

Nailor's premium single duct and fan powered terminals are equipped with inclined opposed blade dampers that provide premium performance and control accuracy. Blades shut-off at 45° in the direction of airflow. This ensures quiet operation with near linear performance for primary air control. Airflow disturbance and hence the turbulence created over a throttling opposed blade damper is less than that produced when compared with a similarly throttling round butterfly type damper design, therefore generating less noise.

Controlled throttling of the airflow is achieved throughout the complete damper rotation from fully open to fully closed, desirable characteristics not found in round butterfly dampers, thereby providing accurate control under all conditions. Opposed blade dampers ensure Nailor customers of a smooth response as airflow is adjusted in response to changing thermostat demand or the damper adjusts to compensate for varying static pressure conditions.

All Nailor dampers feature a solid plated steel 1/2" (13) dia. driveshaft with an indicator mark on the end of the shaft to show damper position.

COMMON COMPONENTS (continued)

Electric Heaters

All Nailor single duct, fan powered and bypass terminal units supplied with electric heaters will have heaters manufactured by Nailor Industries. All electric heaters are factory mounted by Nailor and contain a control enclosure for mounting heater controls. Controls for heaters are described under the Controls Section of this catalog.

Nailor electric coils are options on most terminal units and offer an alternative to a hydronic (water) coil. A few advantages to electric over hydronic heating coils include reduced pressure drop across the coil, thus requiring lower central or terminal fan HP requirements. Another benefit is the lack of water lines which require specialized installation, maintenance and always have the possibility of leaking. Electrical coils can, in many cases, share the same power terminal as the basic terminal unit. This reduces first costs not found with hydronic coils.

Features of Nailor Electric coils:

- High performance ceramic insulators.
- Primary auto-reset high limit thermal cut-out (one per coil in control circuit) to protect against overheating in low airflow situations.
- Secondary manual reset thermal cut-outs.
- Hinged control enclosure access door.
- High grade Class A 80/20 nickel/chrome element wire.
- Staged heat or SCR control.
- ETL listed with the terminal unit as an assembly in accordance with UL Standard 1995 Heating and Cooling Equipment and CAN/CSA-C22.2 No. 236.



Electric Heater



Hot Water Coil

Hot Water Coils

Nailor single duct, fan powered and bypass terminal units are available with factory installed hot water coils with up to four rows for reheat and supplementary heating applications. Coils are custom designed specifically for Nailor terminal units. The number of circuits and header/connection size have been selected to optimize performance.

- Tubes are 1/2" (13) O. D. copper.
- Fins are rippled aluminum, 10 fins per inch.
- Connections: 1/2" (13), 7/8" (22) or 1 3/8" (35) O. D. male solder, dependent on size and number of rows.
- Coils are pressure tested to 350 psi (2413 kPa).
- Water coil valves for electronic control, electric and pneumatic control are available from Nailor.
- AHRI Certified.

CONTROLS

Direct Digital Control (DDC)

Digital Controls dominate today's new construction market. Nailor has a wealth of experience supplying terminal units for use with factory mounted digital controls supplied by others. We have worked with all major controls companies in recent years and have developed standard factory mounting programs to ensure operational efficiency is maximized for all terminal types and applications.

Nailor has designed its VAV terminal units to be generic in nature and compatible with all DDC controllers. Nailor also offers its own EZVAV digital controls for stand-alone and BACnet applications.

Analog Electronic Controls

Pressure Independent: Less costly than DDC, analog controls are well suited to smaller commercial stand-alone applications. Improved controller/actuator and thermostat design. A range of control options are available for all terminal types with standard pressure independent application sequences. Featuring Diamond Flow multi-point sensor for accurate feedback control.

Pressure Dependent: Factory supplied and installed. Pressure dependent controls featuring advance micro-computer electronics and proportional integral control algorithms provide precise temperature control. Available for single duct and by-pass applications.

Pneumatic Controls

Generally used for retrofit applications where the cost of updating to DDC is not warranted. A comprehensive range of factory supplied, installed and calibrated controls are available for pressure independent control applications with all terminal types. Pressure dependent controls are also available for certain terminals and applications.

See Controls Section of this catalog for more details.

NOTES:



SINGLE DUCT TERMINAL UNITS

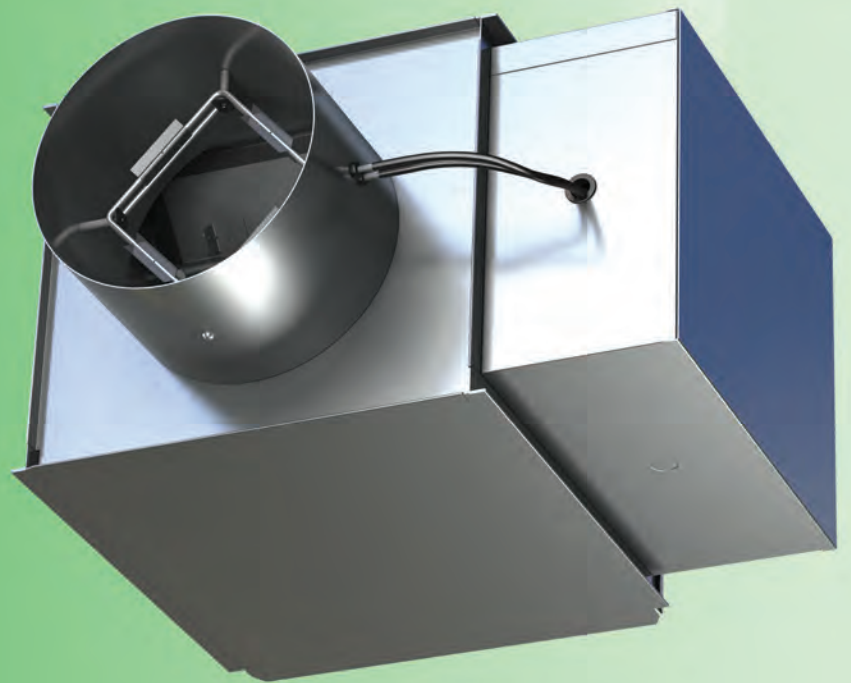

TABLE OF CONTENTS

Page No.

SUPPLY

Product Overview

3000 Series • Variable or Constant Volume **A5**

Introduction and Features

Model 3001 • Cooling • Heating Only **A6**

Model 30RW • Cooling • Hot Water Reheat

Model 30RE • Cooling • Electric Reheat

Dimensional Data

Model 3001 • Basic Unit **A7**

• Integral Sound Attenuator **A8**

Model 30RW • Hot Water Reheat **A9**

• Integral Attenuator plus Hot Water Reheat **A10**

Model 30RE • Electric Reheat **A11**

Options • FMI Removable Flow Sensor **A12**

• Access Door

• FF Round Discharge Collar **A13**

• Leakage Casing

Accessories • MOA Multi-Outlet Attenuator **A14**

• AT Discharge Sound Attenuator

Recommended Airflow Ranges for 3000 Series A15

Performance Data

3000 Series • NC Level Application Guide **A16**

• Discharge Sound Power Levels **A17**

• Radiated Sound Power Levels **A19**

• AHRI Certification and Performance Notes **A20**

Product Overview

3000Q Series • Quiet Type with Dissipative Silencer **A21**

Introduction and Features

Model 3001Q • Cooling • Heating Only **A22**

Model 30RWQ • Cooling • Hot Water Reheat

Model 30REQ • Cooling • Electric Reheat

Dimensional Data

Model 3001Q • Quiet • Dissipative Silencer **A23**

Model 30RWQ • Quiet • Dissipative Silencer • Hot Water Reheat **A24**

Model 30REQ • Quiet • Dissipative Silencer • Electric Reheat

Options • FMI Removable Flow Sensor **A25**

• Access Door

Recommended Airflow Ranges for 3000Q Series A26

Performance Data

3000Q Series • NC Level Application Guide **A27**

• Discharge Sound Power Levels **A28**

• Radiated Sound Power Levels **A29**

• AHRI Certification and Performance Notes **A30**

TABLE OF CONTENTS

	Page No.
Product Overview	
30HQ Series • Hospital Grade • Quiet Type with Dissipative Silencer	A31
Introduction and Features	
Model 30HQ • Cooling • Heating only	A32
Model 30HQW • Cooling • Hot Water Reheat	
Model 30HQE • Cooling • Electric Reheat	
Dimensional Data	
Model 30HQ • Hospital Grade • Dissipative Silencer	A33
Model 30HQW • Hospital Grade • Dissipative Silencer • Hot Water Reheat	A34
Model 30HQE • Hospital Grade • Dissipative Silencer • Electric Reheat	
Recommended Airflow Ranges for 30HQ Series	A35
Performance Data	
30HQ Series • NC Level Application Guide	A36
• Discharge Sound Power Levels	A37
• Radiated Sound Power Levels	A38
• AHRI Certification and Performance Notes	A39
Oversized Casing • Larger Hot Water Coils • Dimensional Data	
Models 30RW, 30RWQ and 30HQW	A40
Performance Data • Hot Water Coil • Capacities	
Models 30RW, 30RWQ and 30HQW	A43
Electric Heating Coil Selection, Capacities and Features	
Models 30RE, 30REQ and 30HQE	A52
EXHAUST	
Product Overview	
30X/HQX Series • Exhaust • Hospital Grade • Quiet Type • Dissipative Silencer	A53
Introduction and Features	
Model 30X • Basic Unit	A54
• Basic Unit • Optional Sound Attenuator	
Dimensional Data	
Model 30X • Basic Unit	A55
• Basic Unit • Optional Sound Attenuator	
Options • Access Door	A56
• FMI Removable Flow Sensor	
Recommended Airflow Ranges for Model 30X	A57
Performance Data	
30X Series • NC Level Application Guide	A58
• Discharge Sound Power Levels	A59
• Radiated Sound Power Levels	A60
30X Series • Optional Sound Attenuator • Fiberglass Liner	
• NC Level Application Guide	A61
• Discharge Sound Power Levels	A62
• Radiated Sound Power Levels	A63

TABLE OF CONTENTS

A

SINGLE DUCT TERMINAL UNITS

	Page No.
30X Series • Optional Sound Attenuator • Steri-Liner	A64
• NC Level Application Guide	A65
• Discharge Sound Power Levels	A66
• Radiated Sound Power Levels	A67
30X Series • AHRI Certification and Performance Notes	A67
Introduction and Features	
30HQX Series • Hospital Grade with Dissipative Silencer	A68
Dimensional Data	
30HQX • Hospital Grade • Dissipative Silencer	A69
Recommended Airflow Ranges for 30HQX Series	A70
Performance Data	
30HQX Series • NC Level Application Guide	A71
• Discharge Sound Power Levels	A72
• Radiated Sound Power Levels	A73
• AHRI Certification and Performance Notes	A74
SUPPLY	
Product Overview	
3100 Series • Variable or Constant Volume	A75
Introduction and Features	
Model 3101 • Cooling • Heating Only	A76
Model 31RW • Cooling • Hot Water Reheat	A76
Dimensional Data	
Model 3101 • Basic Unit	A77
• Integral Sound Attenuator	A78
Model 31RW • Hot Water Reheat	A79
• Integral Attenuator plus Hot Water Reheat	A80
Options • FMI Removable Flow Sensor	A81
• Access Door	
• FF Round Discharge Collar	A82
• Leakage Casing	
Accessories • MOA Multi-Outlet Attenuator	A83
• AT Discharge Sound Attenuator	
Recommended Airflow Ranges for 3100 Series	A84
Performance Data	
3100 Series • NC Level Application Guide	A85
• Discharge Sound Power Levels	A86
• Radiated Sound Power Levels	A88
• AHRI Certification and Performance Notes	A89
Oversized Casing • Larger Hot Water Coils • Dimensional Data	
Model 31RW	A90
Performance Data • Hot Water Coil • Capacities	
Model 31RW	A92
Performance Data Explanation	A101
Liner and Acoustic Media Options	A102

3000 SERIES • VARIABLE OR CONSTANT VOLUME PRODUCT OVERVIEW



Nailor 3000 Series Single Duct Terminal units are simply put, versatile. Whether the requirement calls for a constant or variable air volume (VAV) single duct terminal, an electric or hot water reheat option or requires basic attenuation, the 3000 Series terminal units deliver.

Available in numerous configurations, each 3000 Series is designed to control airflow in response to a control signal. At the center of each unit is the control damper. Constructed of a single blade on smaller units or inclined opposed blades on larger units, the damper provides a more linear flow characteristic than the typical butterfly type. The result is a more accurate flow control, thus providing a more stable zone temperature.

The pressure independent 3000 Series terminal units operate in both constant and variable flow configurations. Unlike a constant volume system, which is sized for the peak demand of the entire building, a VAV system is sized for the instantaneous peak demand of all zones. Since VAV systems modulate airflow based on demand, operating costs are generally reduced compared to constant volume systems as less fan energy and refrigeration is needed.

Numerous options on the 3000 Series allow for application specific customization. Options range from different insulation types, reheat versions, attenuators, control sequences, low temperature and ultra low casing leakage construction to access doors. Controls options include digital, analog electric and pneumatic types suitable for most applications. Depending on the selected controls option, a full NEMA 1 type low voltage enclosure may be included. All pressure independent control options utilize the multi-point averaging Nailor Diamond Flow sensor to measure velocity pressure.

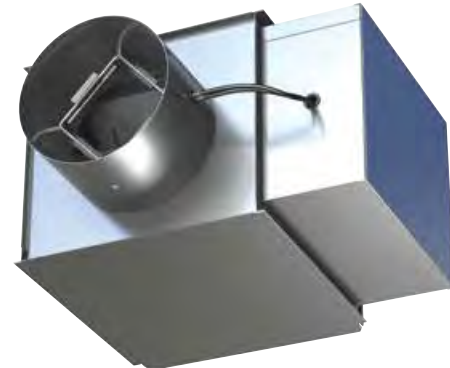

3001 Cooling or Heating Only

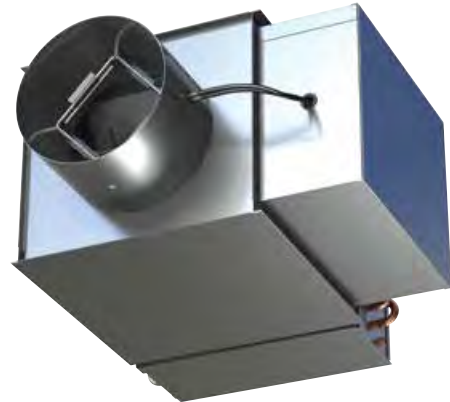

30RW Cooling with Hot Water Reheat



30RE Cooling with Electric Reheat

SINGLE DUCT VARIABLE OR CONSTANT AIR VOLUME

3000 SERIES

Models:

- 3001** Cooling or Heating only
- 30RW** Cooling with Hot Water Reheat
- 30RE** Cooling with Electric Reheat

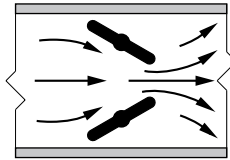

Inclined opposed blade damper configuration minimizes noisy turbulence and provides smooth, accurate, near linear flow control.

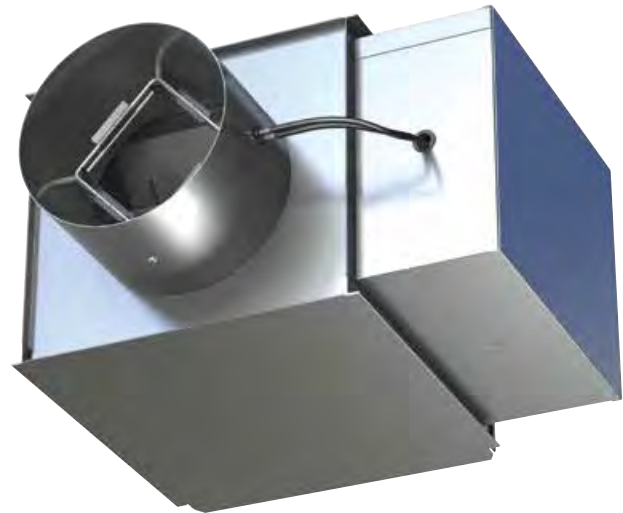

Model 3001

The 3000 Series Single Duct Terminal Units form the backbone of Nailor's single duct line. Utilizing an inclined opposed blade damper, the 3000 Series exhibit a more linear flow characteristic than the common butterfly type. Used in constant volume or VAV applications, the 3000 series provides minimal system pressure drop while offering maximum system flexibility. 3000 Series units are available with electric and hot water reheat as well as options like removable flow sensors and access doors. Each unit is available with multiple insulation types, ranging from standard fiberglass to Indoor Air Quality (IAQ) types.

STANDARD FEATURES:

- 22 ga. (0.86) zinc coated steel casing, mechanically sealed, low leakage construction. Leakage is less than 1% of the terminal rated airflow at 1" w.g. (249 Pa).
- 16 ga. (1.61) corrosion-resistant steel inclined opposed blade damper with extruded PVC seals (single blade on size 4, 5 and 6). 45° rotation, CW to close, tight shut-off. Damper leakage is less than 2% of nominal flow at 3" w.g. (746 Pa).
- Self-lubricating Celcon® bearings.
- 1/2" (13) dia. plated steel drive shaft. An indicator mark on the end of the shaft shows damper position.
- Inclined opposed blade damper is inherently more linear in its flow characteristics than the standard butterfly type damper. More accurate flow control is ensured, which reduces hysteresis for more stable control of the temperature in the zone.
- Available in 11 unit sizes to handle from 0 – 8300 cfm (0 – 3917 l/s).
- Maximum unit height is only 12 1/2" (318) for sizes 4 through 16. Unit sizes 4 through 10 feature round inlets and 12 through 16 features flat oval

equivalent inlets. Size 24 x 16 features a rectangular inlet.

- Multi-point averaging Diamond Flow Sensor. Aluminum construction. Supplied with balancing tees for field calibration and balancing.
- Rectangular discharge with slip and drive cleat duct connection.
- Full NEMA 1 type low voltage enclosure for factory mounted controls.
- 3/4" (19) dual density fiberglass insulation maximizes acoustical and thermal performance. 4 lb. high density skin is treated to resist abrasion and erosion from airflow. Edges are coated. Meets requirements of NFPA 90A and UL 181.
- Single point electrical or pneumatic main air connection (except 600V with electric heat).
- Right-hand controls location is standard (shown) when looking in direction of airflow. Optional left hand controls mounting is available. Unit is flippable. Caution: If unit has access door.
- Independently tested and certified laboratory performance data.

Options:

- Steri-Liner.
- Fiber-Free Liner.
- Solid metal liner.
- Removable Flow Sensor.
- 1" (25) Fiberglass liner.
- Bottom access door.
- 24 VAC Control transformer.
- Hanger bracket.
- Controls enclosure for field or factory mounted controls.
- Dust tight enclosure seal.
- Low temperature construction (thermally isolated inlet collar and non porous steri-liner construction).
- Ultra Low Leakage casing.
- Bottom mount controls enclosure.
- Seismic Certification.
- Oversized casing.



Intertek

Dimensions

Model 3001 • Basic Unit

Digital and Analog Electronic Controls

- A full NEMA 1 controls enclosure is provided for factory mounted controls. Optional for field mounted controls.

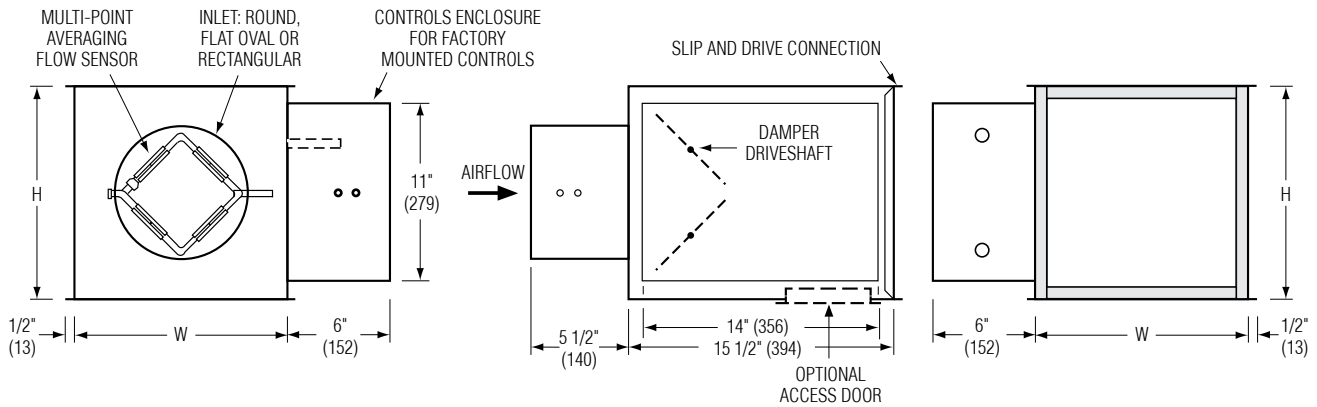

Digital and Analog Electronic Controls with Bottom Mount Control Enclosure

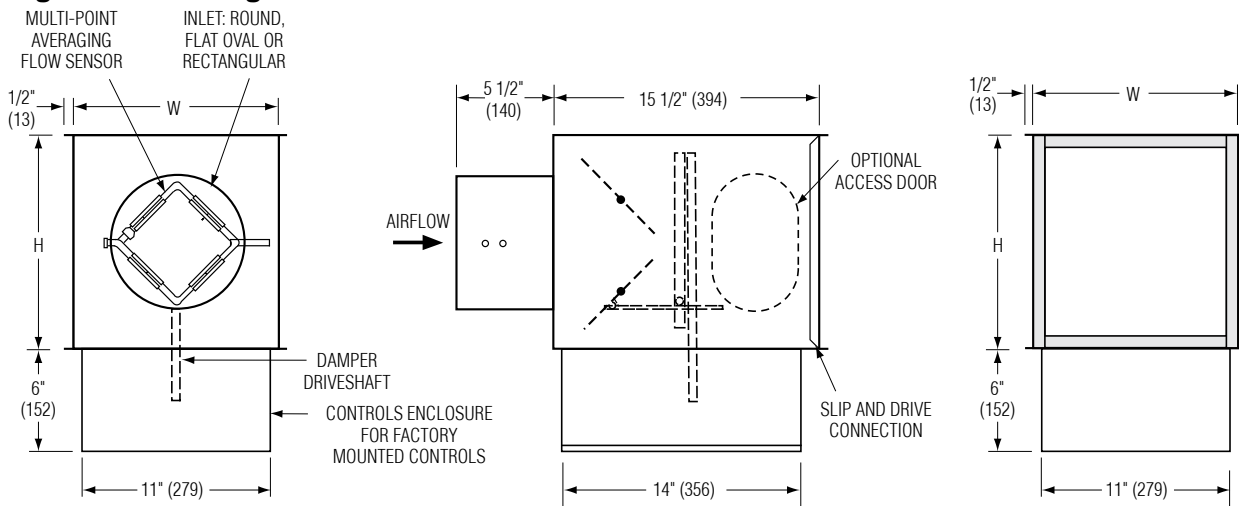

Pneumatic Controls

- Universal pneumatic control mounting panel features double wall stand-off construction for strength and rigidity. Controls mounting screws do not penetrate terminal casing.

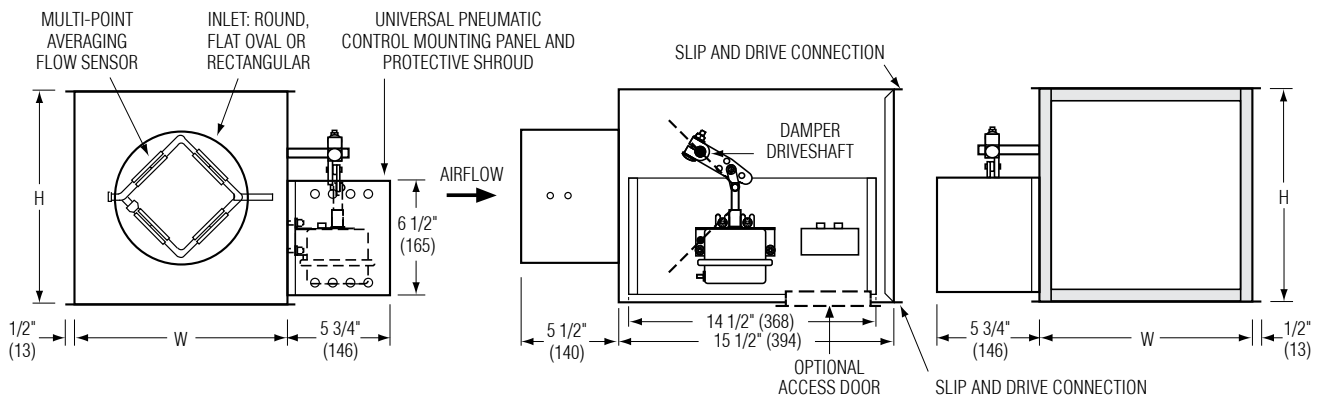

Dimensions

Model 3001 • Integral Sound Attenuator

Digital and Analog Electronic Controls

- Single continuous length terminal construction minimizes casing leakage.
- Continuous internal insulation reduces insulation seams and minimizes airflow disturbance.
- Supplied with same liner as basic unit.

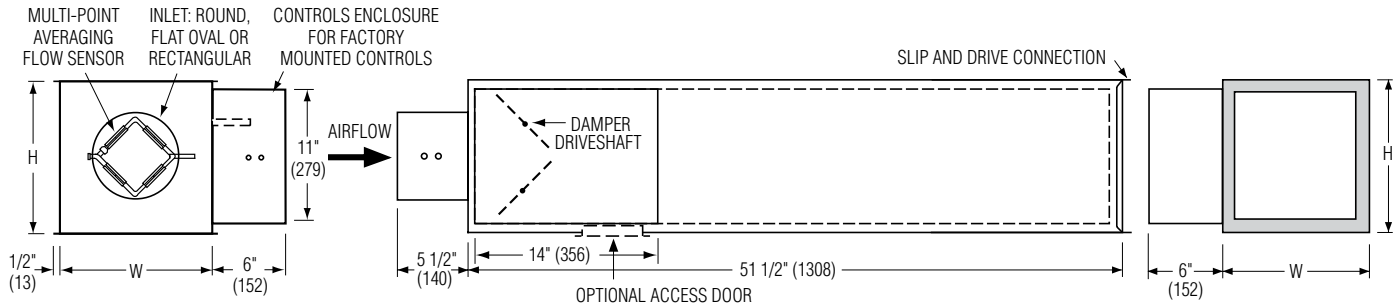

Pneumatic Controls

- Single continuous length terminal construction minimizes casing leakage.
- Continuous internal insulation reduces insulation seams and minimizes airflow disturbance.
- Supplied with same liner as basic unit.

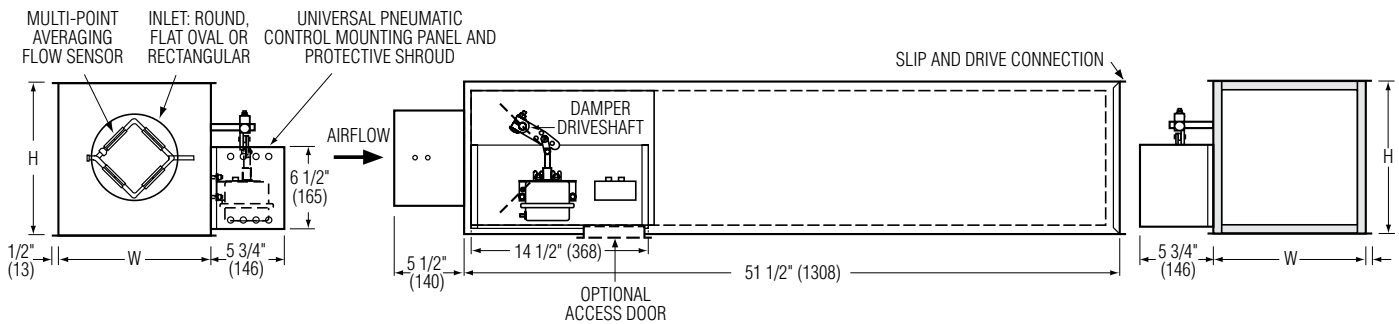

Dimensional Data

Unit Size	W	H	Inlet Size
4	10 (254)	10 (254)	3 7/8 (98) Round
5	10 (254)	10 (254)	4 7/8 (124) Round
6	10 (254)	10 (254)	5 7/8 (149) Round
7	12 (305)	12 1/2 (318)	6 7/8 (175) Round
8	12 (305)	12 1/2 (318)	7 7/8 (200) Round
9	14 (356)	12 1/2 (318)	8 7/8 (225) Round
10	14 (356)	12 1/2 (318)	9 7/8 (251) Round
12	18 (457)	12 1/2 (318)	12 15/16 x 9 13/16 (329 x 249) Oval
14	24 (610)	12 1/2 (318)	16 1/16 x 9 13/16 (408 x 249) Oval
16	28 (711)	12 1/2 (318)	19 3/16 x 9 13/16 (487 x 249) Oval
24 x 16	38 (965)	18 (457)	23 7/8 x 15 7/8 (606 x 403) Rect.

A

SINGLE DUCT TERMINAL UNITS

Dimensions

Model 30RW • Hot Water Reheat Coil

- One, two, three and four row available.
- Hot water coils have copper tubes and aluminum ripple fins. Coils have 1/2" (13), 7/8" (22) or 1 3/8" (35) O.D. sweat connections.
- Right or left hand coil connection is determined by looking through the terminal inlet in the direction of airflow.
- Galvanized steel casing with slip and drive discharge duct connection.
- Optional low leakage gasketed access door is recommended for coil access and cleaning.
- AHRI Certified coils.
- Coil Performance data on pages A43-A51.
- Oversized Casing option on pages A40-A42.

Digital and Analog Electronic Controls

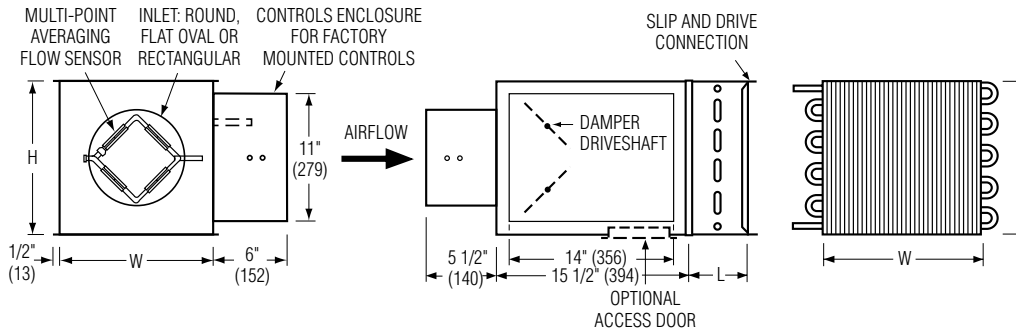

Digital and Analog Electronic Controls with Bottom Mount Controls location

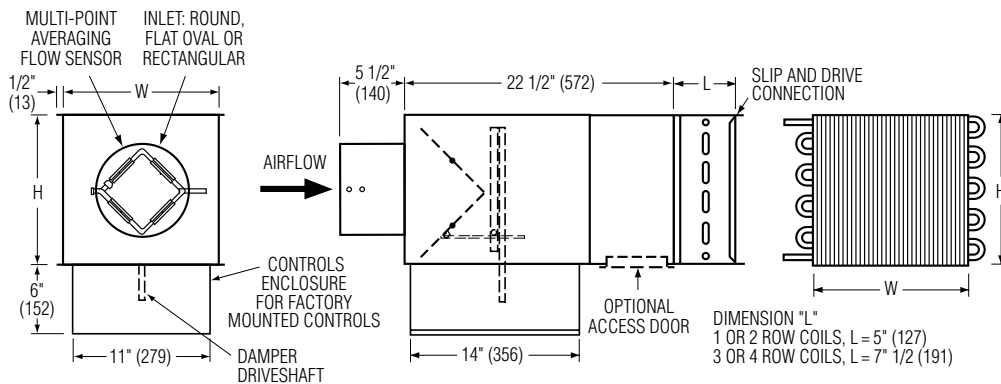

Pneumatic Controls

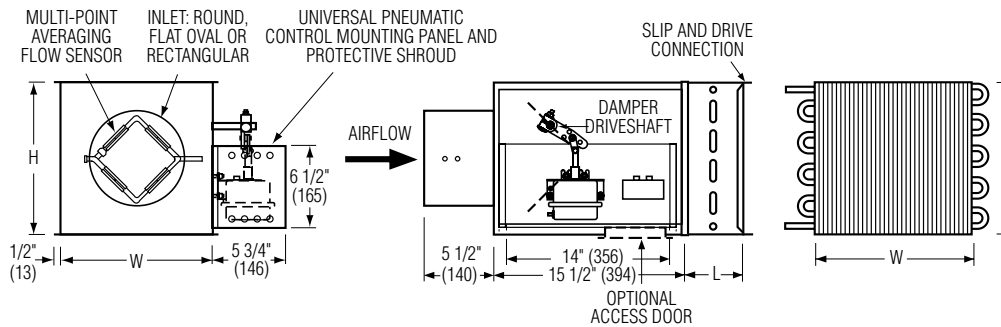

Dimensions

Model 30RW • Integral Attenuator plus Hot Water Reheat Coil

- All the benefits of both the Integral Sound Attenuator and the Hot Water Coils in one.
- Coil performance data on pages A43-A51.

Digital and Analog Electronic Controls

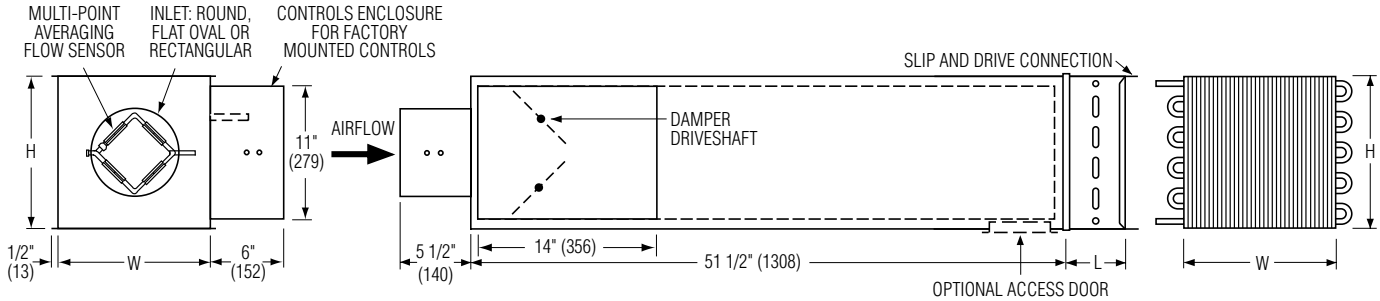

Digital and Analog Electronic Controls with Bottom Mount Controls Location

- Single continuous length terminal construction minimizes casing leakage.
- Continuous internal insulation reduces insulation seams and minimizes airflow disturbance.
- Supplied with same liner as basic unit.

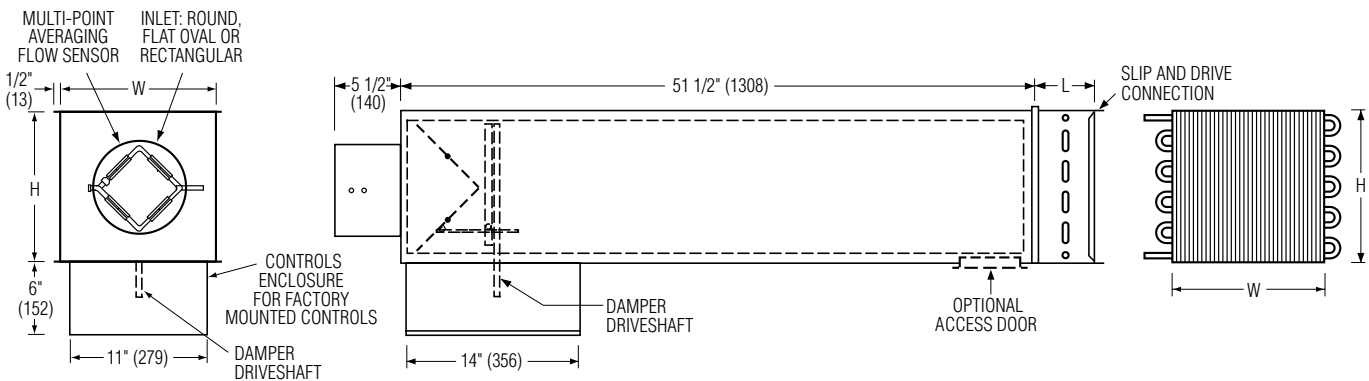

Dimensional Data

Unit Size	W	H	Inlet Size	Coil Connections				Hot Water Coil	
				1 Row	2 Row	3 Row	4 Row	L (1 & 2 Row)	L (3 & 4 Row)
4	10 (254)	10 (254)	3 7/8 (98) Round	1/2 (13)	7/8 (22)	7/8 (22)	7/8 (22)	5 (127)	7 1/2 (191)
5	10 (254)	10 (254)	4 7/8 (124) Round	1/2 (13)	7/8 (22)	7/8 (22)	7/8 (22)	5 (127)	7 1/2 (191)
6	10 (254)	10 (254)	5 7/8 (149) Round	1/2 (13)	7/8 (22)	7/8 (22)	7/8 (22)	5 (127)	7 1/2 (191)
7	12 (305)	12 1/2 (318)	6 7/8 (175) Round	1/2 (13)	7/8 (22)	7/8 (22)	7/8 (22)	5 (127)	7 1/2 (191)
8	12 (305)	12 1/2 (318)	7 7/8 (200) Round	1/2 (13)	7/8 (22)	7/8 (22)	7/8 (22)	5 (127)	7 1/2 (191)
9	14 (356)	12 1/2 (318)	8 7/8 (225) Round	1/2 (13)	7/8 (22)	7/8 (22)	7/8 (22)	5 (127)	7 1/2 (191)
10	14 (356)	12 1/2 (318)	9 7/8 (251) Round	1/2 (13)	7/8 (22)	7/8 (22)	7/8 (22)	5 (127)	7 1/2 (191)
12	18 (457)	12 1/2 (318)	12 15/16 x 9 13/16 (329 x 249) Oval	1/2 (13)	7/8 (22)	7/8 (22)	7/8 (22)	5 (127)	7 1/2 (191)
14	24 (610)	12 1/2 (318)	16 1/16 x 9 13/16 (408 x 249) Oval	1/2 (13)	7/8 (22)	7/8 (22)	7/8 (22)	5 (127)	7 1/2 (191)
16	28 (711)	12 1/2 (318)	19 3/16 x 9 13/16 (487 x 249) Oval	7/8 (22)	7/8 (22)	7/8 (22)	7/8 (22)	5 (127)	7 1/2 (191)
24 x 16	38 (965)	18 (457)	23 7/8 x 15 7/8 (606 x 403) Rect.	7/8 (22)	7/8 (22)	1 3/8 (35)	1 3/8 (35)	5 (127)	7 1/2 (191)

A SINGLE DUCT TERMINAL UNITS

Dimensions

Model 30RE • Integral Electric Reheat

Digital and Analog Electronic Controls

- Electric coil is factory mounted in an integral extended plenum section.
- Perforated diffuser plate minimizes air stratification.
- Full details and selection guide on page A52.

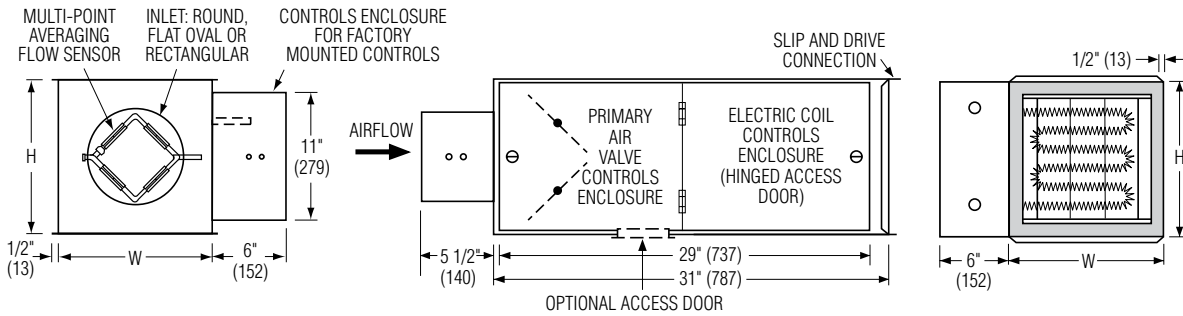

Digital and Analog Electronic Controls with Bottom Mount Control Enclosure

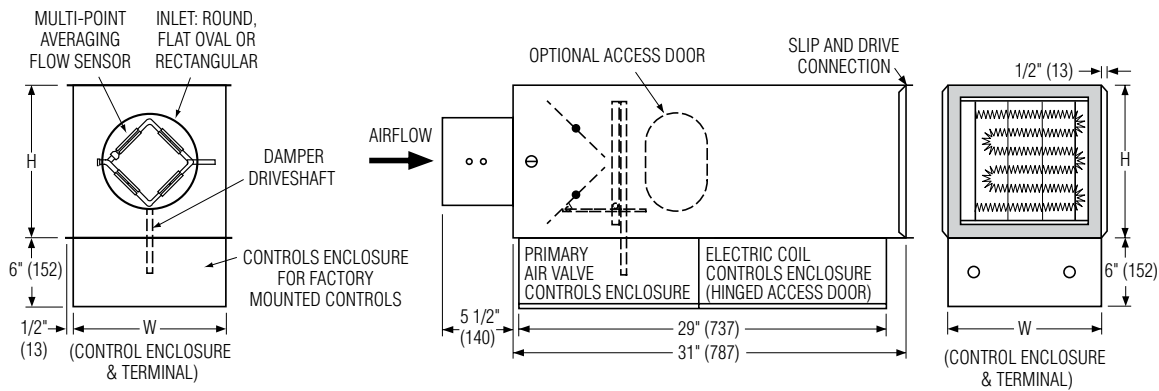

Dimensional Data

Unit Size	W	H	Inlet Size
4	10 (254)	10 (254)	3 7/8 (98) Round
5	10 (254)	10 (254)	4 7/8 (124) Round
6	10 (254)	10 (254)	5 7/8 (149) Round
7	12 (305)	12 1/2 (318)	6 7/8 (175) Round
8	12 (305)	12 1/2 (318)	7 7/8 (200) Round
9	14 (356)	12 1/2 (318)	8 7/8 (225) Round
10	14 (356)	12 1/2 (318)	9 7/8 (251) Round
12	18 (457)	12 1/2 (318)	12 15/16 x 9 13/16 (329 x 249) Oval
14	24 (610)	12 1/2 (318)	16 1/16 x 9 13/16 (408 x 249) Oval
16	28 (711)	12 1/2 (318)	19 3/16 x 9 13/16 (487 x 249) Oval
24 x 16	38 (965)	18 (457)	23 7/8 x 15 7/8 (606 x 403) Rect.

Options:

FMI Removable Flow Sensor

The (FMI) Removable Flow Sensor is a multi-point averaging airflow sensor. Designed to provide accurate sensing by sampling air velocities in four quadrants of a duct, the differential pressure flow sensor provides an averaged reading at an amplification of approximately 2.5 times the velocity pressure, dependent upon nominal size.

Features:

- Removable for cleaning.
- All metal construction - no combustible materials in the air stream.
- Amplifies velocity pressure approximately 2.5 times to give a wide range of useful output signal vs. flow.
- Compact size allows for easy removal in tight spaces.
- Sensor design minimizes pressure drop and regenerated noise.
- Label provided on each unit gives airflow direction.
- Multi-point sensing gives an accurate output signal with a maximum deviation of only $\pm 5\%$ with a hard 90 degree elbow, provided a straight inlet condition with a minimum length of two equivalent duct diameters is provided.

Round or Flat Oval Inlet

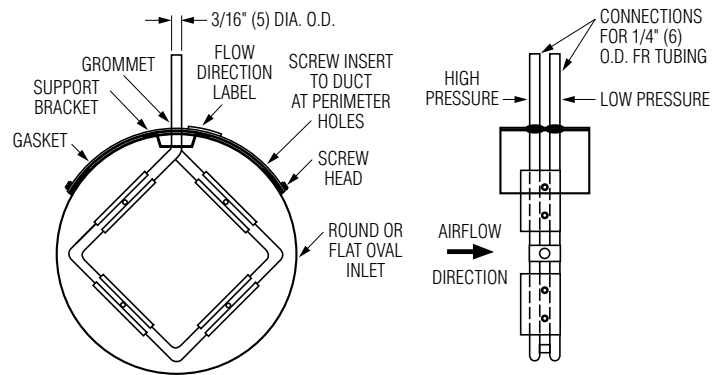

Rectangular Inlet

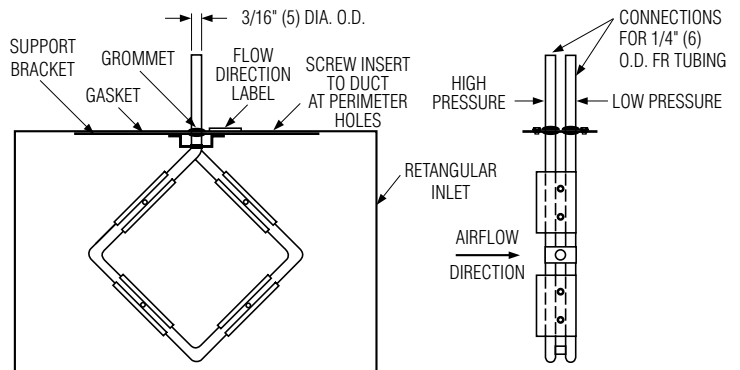

Access Door

Ultra-low leakage, premium quality and performance. Flat oval design.

- Die formed 22 ga. (0.85) galvanized steel flanged frame and door panel.
- Positive bulb door seal.
- Plated steel camlock fasteners.
- 1" (25) insulation with 22 ga. (0.85) galv. backing plate.
- Leakage tested in conformance with British Standard DW/142 Class C.
- See 0800-1 submittal for more detailed information.

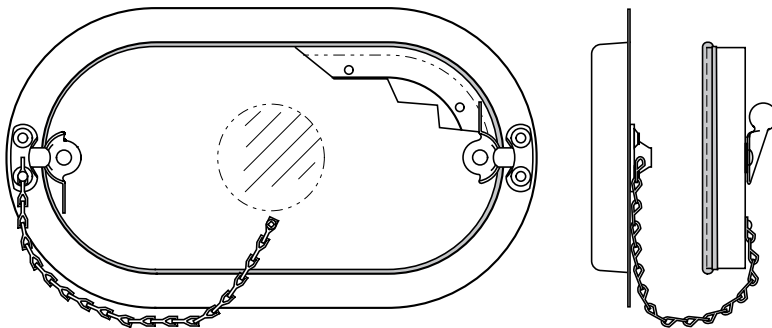

Terminal Unit Size	Nominal Door Size	Max. Leakage 8" w.g. (2 kPa) cfm
4 - 12	8" x 5" (203 x 127)	0.036 cfm (1.02 l/min.)
14 - 24 x 16	12" x 6" (305 x 152)	0.064 cfm (1.8 l/min.)

FF Round Discharge Collar

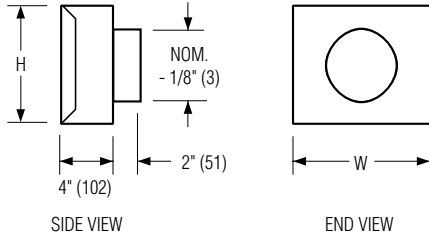

Unit Size	W	H	FF Outlet Size / Oval
4, 5, 6	10 (254)	10 (254)	4, 5, 6 (102, 127, 152)
7, 8	12 (305)	12 1/2 (318)	7, 8 (178, 203)
9, 10	14 (356)	12 1/2 (318)	9, 10 (229, 254)
12	18 (457)	12 1/2 (318)	12 (305)
14	24 (610)	12 1/2 (318)	14 (356)
16	28 (711)	12 1/2 (318)	16 (406)
24 x 16	38 (965)	18 (457)	—

Ultra Low Leakage Casing (ULC) Option, CFM (l/s)

Inlet Size	Pressure, w.g. (Pa)			
	0.5" (124)	1.0" (249)	3" (746)	6" (1049)
4, 5, 6	1 (0.5)	1 (0.5)	3 (1)	6 (3)
7, 8	1 (0.5)	2 (1)	4 (2)	7 (3)
9, 10	1 (0.5)	2 (1)	4 (2)	8 (4)
12	2 (1)	3 (1)	5 (2)	9 (4)
14	2 (1)	3 (1)	5 (2)	9 (4)
16	2 (1)	3 (1)	5 (2)	10 (5)
24 x 16	3 (1)	4 (2)	6 (3)	12 (6)

The ULC option consists of silicone applied to all internal seams during assembly, resulting in an air tight casing to meet the strictest project specifications.

Standard Leakage Casing, CFM (l/s)

Inlet Size	Pressure, w.g. (Pa)		
	0.25" (62)	0.5" (124)	1.0" (249)
4, 5, 6	3 (1)	4 (2)	3 (1)
7, 8	2 (1)	3 (1)	7 (3)
9, 10	2 (1)	3 (1)	5 (2)
12	2 (1)	3 (1)	6 (3)
14	3 (1)	4 (2)	4 (2)
16	3 (1)	4 (2)	6 (3)
24 x 16	7 (3)	9 (4)	7 (3)

Accessories:

Accessories ordered as separate models.

MOA (Multi-Outlet Attenuator)

MOA303 3' (916) Long

MOA305 5' (1524) Long

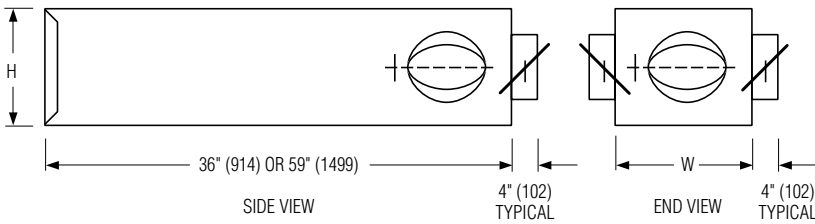

Unit Size	W	H	No. of Outlets	Outlet Size
4, 5, 6	10 (254)	10 (254)	1, 2, or 3	6 (152)
7, 8	12 (305)	12 1/2 (318)	2, 3, 4 or 5	6, 8 (152, 203)
9, 10	14 (356)	12 1/2 (318)	3, 4 or 5	8 (203)
	14 (356)	12 1/2 (318)	2, 3 or 4	10 (254)
12	18 (457)	12 1/2 (318)	4 or 5	8 (203)
	18 (457)	12 1/2 (318)	3, 4 or 5	10 (254)
14	28 (711)	12 1/2 (318)	4 or 5	10 (254)
16	28 (711)	12 1/2 (318)	4 or 5	10 (254)

FEATURES:

- 22 ga. (0.86) galvanized steel construction, mechanically sealed, low leakage construction.
- Shipped loose for field attachment.
- Only one outlet size to be specified per M.O.A. No mixing of outlet sizes on the same unit.
- Number and size of outlets on M.O.A. not to exceed the limits listed in table, both maximum quantity of outlets and maximum size of outlet.
- All round outlets include manual dampers with hand locking quadrant.
- 3/4" (19) dual density insulation, exposed edges coated to prevent erosion.
- Denotes inlet airflow direction. →
- Slip and drive cleat duct connection.
- For special outlet sizes and arrangements, consult your Nailor representative.

OPTIONS:

- Steri-Liner.
- Fiber-Free Liner.
- 1" (25) Fiberglass Liner.

Standard Outlet Arrangements

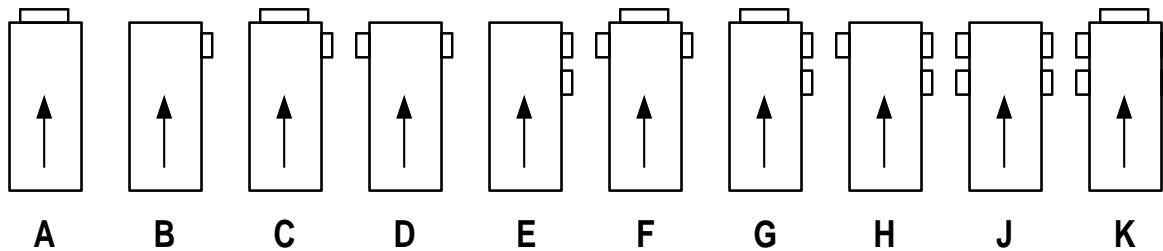

AT Discharge Sound Attenuator

AT303 3' (916) Long

AT305 5' (1524) Long

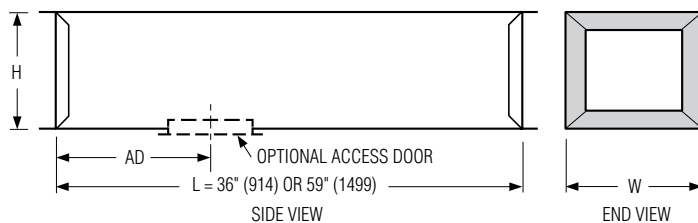

Unit Size	W	H	AD
4, 5, 6	10 (254)	10 (254)	12 (305)
7, 8	12 (305)	12 1/2 (318)	12 (305)
9, 10	14 (356)	12 1/2 (318)	12 (305)
12	18 (457)	12 1/2 (318)	12 (305)
14	24 (610)	12 1/2 (318)	12 (305)
16	28 (711)	12 1/2 (318)	12 (305)
24 x 16	38 (965)	18" (457)	12 (305)

FEATURES:

- 22 ga. (0.86) galvanized steel construction.
- Shipped loose for field attachment.
- Slip and drive connection.
- 3/4" (14) dual density fiberglass insulation, exposed edges coated to prevent erosion as standard.

OPTIONS:

- Steri-Liner.
- Fiber-Free Liner.
- Solid Metal Liner.
- 1" (25) Fiberglass Liner.
- 2" (51) Fiberglass Liner.
- Perforated Metal Liner.
- Steri-Liner with Perforated Liner.
- Access Door
 - Sizes 4 to 12 : 8" x 5" (203 x 127) Oval;
 - Sizes 14 to 24 x 16: 12" x 6" (305 x 152) Oval.

Note: Select Insulation to match VAV terminal.

Recommended Airflow Ranges For Single Duct Pressure Independent Terminal Units

The recommended airflow ranges below are for 3000 Series single duct terminal units with pressure independent controls and are presented as ranges for total and controller specific minimum and maximum airflow. Airflow ranges are based upon maintaining reasonable sound levels and controller limits using Nailor's Diamond Flow Sensor as the airflow measuring device. For a given unit size, the minimum, auxiliary minimum (where applicable) and the maximum flow setting must be within the range limits to ensure pressure independent operation, accuracy and repeatability.

Minimum airflow limits are based upon .02" w.g. (5 Pa) differential pressure signal from Diamond Flow Sensor on analog/ digital controls and .03" (7.5) for pneumatic controllers. This is a realistic low limit for many transducers used in the digital controls industry. Check your controls supplier for minimum limits. Setting airflow minimums lower, may cause damper hunting and result in a failure to meet minimum ventilation requirements. Factory settings will therefore not be made outside these ranges; however, a minimum setting of zero (shut-off) is an available option on pneumatic units. Where an auxiliary setting is specified, the value must be greater than the minimum setting.

The high end of the tabulated Total Airflow Range on pneumatic and analog electronic controls represents the Diamond Flow Sensor's differential pressure reading at 1" w.g. (249 Pa). The high end airflow range for digital controls is represented by the indicated transducer differential pressure.

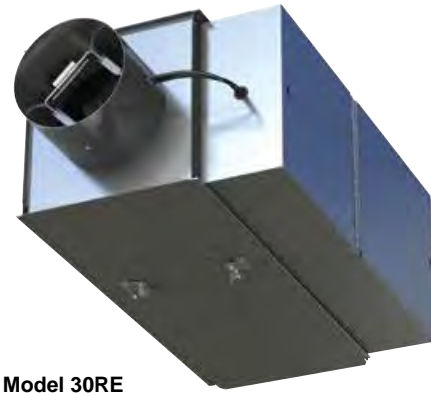

Model 30RE

ASHRAE 130 "Performance Rating of Air Terminals" is the method of test for the certification program. The "standard rating condition" (certification rating point) airflow volumes for each terminal unit size are tabulated below per AHRI Standard 880. These air volumes equate to an approximate inlet velocity of 2000 fpm (10.2 m/s).

When digital or other controls are mounted by Nailor, but supplied by others, these values are guidelines only, based upon experience with the majority of controls currently available. Controls supplied by others for factory mounting are configured and calibrated in the field. Airflow settings on pneumatic and analog controls supplied by Nailor are factory preset when provided.

Imperial Units, Cubic Feet per Minute

Unit Size	Inlet Type	Total Airflow Range, cfm	Airflow at 2000 fpm Inlet Velocity (nom.), cfm	Range of Minimum and Maximum Settings, cfm							
				Pneumatic 3000 Controller		Analog Electronic Controls		Digital Controls			
				Transducer Differential Pressure ("w.g.)							
				Min.	Max.	Min.	Max.	Min.	Max.		
		.03	1.0	.02	1.0	.02	1.0	1.25	1.5		
4	Round	0 – 225	150	30	180	25	180	25	180	200	225
5		0 – 400	250	55	325	45	325	45	325	360	400
6		0 – 550	400	80	450	65	450	65	450	500	550
7	Round	0 – 800	550	115	650	95	650	95	650	725	800
8		0 – 1100	700	155	900	125	900	125	900	1000	1100
9		0 – 1400	900	200	1150	165	1150	165	1150	1285	1400
10		0 – 1840	1100	260	1500	215	1500	215	1500	1675	1840
12	Flat Oval	0 – 2500	1600	355	2050	290	2050	290	2050	2300	2500
14		0 – 3370	2100	440	2550	360	2550	360	2550	2850	3125
16		0 – 4510	2800	525	3040	430	3040	430	3040	3400	3725
24 x 16	Rect.	0 – 8330	5350	1180	6800	960	6800	960	6800	7600	8330

Metric Units, Liters per Second

Unit Size	Inlet Type	Total Airflow Range, l/s	Airflow at 10.2 m/s Inlet Velocity (nom.), l/s	Range of Minimum and Maximum Settings, l/s							
				Pneumatic 3000 Controller		Analog Electronic Controls		Digital Controls			
				Transducer Differential Pressure (Pa)							
				Min.	Max.	Min.	Max.	Min.	Max.		
		7.5	249	5	249	5	249	311	374		
4	Round	0 – 106	71	14	85	12	85	12	85	94	106
5		0 – 189	118	26	153	21	153	21	153	170	189
6		0 – 260	189	38	212	31	212	31	212	236	260
7	Round	0 – 378	260	54	307	45	307	45	307	342	378
8		0 – 519	330	73	425	59	425	59	425	472	519
9		0 – 661	425	94	543	78	543	78	543	606	661
10		0 – 868	519	123	708	101	708	101	708	790	868
12	Flat Oval	0 – 1180	755	168	967	137	967	137	967	1085	1180
14		0 – 1590	991	208	1203	170	1203	170	1203	1345	1475
16		0 – 2128	1321	248	1435	203	1435	203	1435	1604	1758
24 x 16	Rect.	0 – 3931	2525	557	3209	453	3209	453	3209	3586	3931

Performance Data • NC Level Application Guide

3000 Series • Basic Unit

Fiberglass Liner

SINGLE DUCT TERMINAL UNITS

Inlet Size	Airflow cfm / s		Min. inlet ΔPs "w.g. Pa		NC Levels @ Inlet Pressure (ΔPs) shown																	
					DISCHARGE (basic assembly)					DISCHARGE w/ 36" (914) attenuator					RADIATED							
					Min. ΔPs	0.5" w.g. (125 Pa)	1.0" w.g. (250 Pa)	1.5" w.g. (375 Pa)	2.0" w.g. (500 Pa)	3.0" w.g. (750 Pa)	Min. ΔPs	0.5" w.g. (125 Pa)	1.0" w.g. (250 Pa)	1.5" w.g. (375 Pa)	2.0" w.g. (500 Pa)	3.0" w.g. (750 Pa)	Min. ΔPs	0.5" w.g. (125 Pa)	1.0" w.g. (250 Pa)	1.5" w.g. (375 Pa)	2.0" w.g. (500 Pa)	3.0" w.g. (750 Pa)
4	225	106	0.53	133	21	-	30	33	34	36	-	-	29	33	33	34	-	*	-	23	25	29
	200	94	0.43	106	20	25	29	33	34	35	-	25	29	33	33	34	-	-	-	21	24	28
	150	71	0.10	25	-	21	26	29	30	30	-	-	26	28	29	30	-	-	-	21	22	22
	100	47	0.11	28	-	-	21	21	21	21	-	-	20	-	-	20	-	-	-	-	20	23
	75	35	0.06	16	-	-	-	-	-	-	-	-	-	-	-	-	-	-	-	-	-	20
5	400	189	0.19	48	-	23	28	30	33	35	-	20	26	30	31	33	-	-	-	23	26	31
	300	142	0.11	28	-	23	29	30	33	35	-	23	29	30	33	34	-	-	-	21	23	28
	250	118	0.05	12	-	23	28	31	33	34	-	-	28	30	33	34	-	-	-	-	22	25
	200	94	0.05	13	-	21	25	28	29	30	-	20	25	25	28	29	-	-	-	-	20	22
	125	59	0.02	5	-	-	20	21	21	21	-	-	20	20	20	20	-	-	-	-	-	-
6	550	260	0.01	2	-	25	29	33	36	38	-	20	25	30	33	34	-	-	20	25	28	31
	450	212	0.01	2	-	23	28	33	35	36	-	20	25	30	31	33	-	-	-	22	24	29
	400	189	0.01	2	-	20	25	30	31	33	-	-	23	26	29	30	-	-	-	21	25	29
	200	94	0.01	2	-	-	21	24	24	24	-	-	21	23	24	24	-	-	-	-	-	20
	100	47	0.01	2	-	-	-	-	-	-	-	-	-	-	-	-	-	-	-	-	-	-
7	800	378	0.01	2	-	24	28	31	35	38	-	23	26	30	34	36	25	-	22	28	33	37
	650	307	0.01	2	-	23	28	33	37	37	-	23	26	31	34	36	20	-	21	24	29	34
	550	260	0.01	2	-	-	24	30	31	34	-	-	24	28	30	33	-	-	-	24	28	32
	335	158	0.01	2	-	-	21	25	25	26	-	-	20	24	24	25	-	-	-	20	22	24
	225	106	0.01	2	-	-	-	-	-	20	-	-	-	-	-	-	-	-	-	-	-	-
8	1100	519	0.01	2	25	28	31	34	37	40	24	26	29	31	36	39	-	20	25	29	31	35
	900	425	0.01	2	20	24	29	33	36	38	-	23	26	31	34	37	-	-	23	26	29	33
	700	330	0.01	2	-	21	26	31	35	38	-	-	25	30	33	35	-	-	21	24	26	31
	600	283	0.01	2	-	-	25	30	34	36	-	-	23	29	30	31	-	-	-	23	25	31
	400	189	0.01	2	-	-	-	25	26	28	-	-	-	24	24	24	-	-	-	20	21	25
9	1400	661	0.01	2	23	28	31	34	37	39	21	28	30	33	36	39	20	20	23	28	34	38
	1250	590	0.01	2	-	25	29	33	35	38	-	24	29	31	35	37	-	20	22	26	33	36
	900	425	0.01	2	-	-	24	28	31	35	-	-	23	28	30	33	-	-	-	23	28	31
	675	319	0.01	2	-	-	23	28	30	33	-	-	23	28	30	31	-	-	-	20	25	26
	450	212	0.01	2	-	-	-	23	24	25	-	-	-	21	23	24	-	-	-	-	20	22
10	1850	873	0.01	2	24	31	34	36	38	39	24	30	31	34	36	38	22	22	26	31	33	37
	1650	779	0.01	2	20	28	31	35	37	39	-	28	31	33	35	37	-	20	25	30	31	36
	1100	519	0.01	2	-	21	25	28	31	35	-	-	21	25	29	31	-	-	21	24	25	31
	825	389	0.01	2	-	-	20	25	29	31	-	-	-	21	25	29	-	-	-	21	23	28
	550	260	0.01	2	-	-	-	21	24	26	-	-	-	-	21	23	-	-	-	-	-	22
12	2500	1180	0.01	2	-	31	34	35	38	40	-	31	33	35	36	38	29	28	31	34	35	40
	2000	944	0.01	2	-	28	30	31	35	37	-	26	28	30	31	34	22	25	29	31	33	37
	1600	755	0.01	2	-	23	26	29	33	35	-	20	23	26	29	33	-	20	25	28	30	35
	1200	566	0.01	2	-	-	21	25	29	33	-	-	-	23	25	29	-	-	20	24	28	31
	800	378	0.01	2	-	-	-	-	21	24	-	-	-	-	-	21	-	-	-	20	21	24
14	3125	1475	0.01	2	23	31	34	35	38	39	20	31	33	34	36	38	29	28	31	36	39	43
	2700	1274	0.01	2	-	29	30	33	35	37	-	28	29	31	34	36	24	25	30	34	37	40
	2100	991	0.01	2	-	21	25	29	33	36	-	21	24	28	30	34	-	21	26	31	34	37
	1550	731	0.01	2	-	-	21	26	30	33	-	-	20	25	26	29	-	-	24	28	30	34
	1050	495	0.01	2	-	-	-	21	24	26	-	-	-	21	23	24	-	-	-	24	26	28
16	3725	1758	0.03	8	-	29	31	33	35	38	-	28	30	31	35	38	30	30	33	37	40	44
	3500	1652	0.03	8	-	26	29	31	34	36	-	24	28	31	34	35	28	30	33	36	39	43
	2800	1321	0.02	6	-	23	26	29	31	34	-	21	25	29	30	33	23	24	29	34	36	40
	2100	991	0.02	4	-	-	20	25	26	30	-	-	-	23	25	28	-	-	26	30	34	36
	1400	661	0.01	3	-	-	-	-	21	24	-	-	-	-	-	23	-	-	21	26	29	31
24 x 16	8330	3931	0.02	5	49	49	49	52	53	53	48	48	48	50	52	52	44	44	49	51	54	57
	7000	3303	0.02	4	45	45	45	48	49	50	44	44	44	46	48	49	40	41	47	49	51	55
	6000	2831	0.01	2	40	41	43	45	46	48	39	40	41	44	45	46	36	39	45	47	49	53
	5350	2525	0.01	2	35	38	40	43	45	46	34	36	39	41	44	45	32	38	44	46	48	51
	4000	1888	0.01	2	25	31	35	38	40	43	24	30	34	36	39	41	24	35	39	43	45	47
3000	1416	0.01	2	-	24	29	33	35	38	-	23	28	31	34	37	20	31	36	38	40	44	

Performance Notes:

1. NC Levels are calculated based on procedures as outlined on page A101.
2. Dash (-) in space indicates a NC less than 20.
3. Asterisk (*) in space indicates that the minimum inlet static pressure requirement is greater than 0.5" w.g. (125 Pa) at rated airflow.

Performance Data • Discharge Sound Power Levels

3000 Series • Basic Unit

Fiberglass Liner



Inlet Size	Airflow		Min. inlet ΔPs		Sound Power Octave Bands @ Inlet Pressure (ΔPs) shown																																									
					Minimum ΔPs							0.5" wg (125Pa) ΔPs							1.0" wg (250Pa) ΔPs							1.5" wg (375Pa) ΔPs							2.0" wg (500Pa) ΔPs							3.0" wg (750Pa) ΔPs						
					2	3	4	5	6	7	2	3	4	5	6	7	2	3	4	5	6	7	2	3	4	5	6	7	2	3	4	5	6	7	2	3	4	5	6	7						
4	225	106	0.53	133	65	60	58	60	52	47	*	*	*	*	*	*	70	69	65	61	52	49	72	71	67	62	54	51	73	72	68	64	57	54	74	74	70	66	60	57						
	200	94	0.43	106	64	58	56	58	49	46	67	65	63	61	50	46	69	68	64	60	51	48	72	71	66	62	54	51	73	72	67	63	56	54	73	73	70	67	59	57						
	150	71	0.10	25	61	53	50	50	40	37	65	62	55	51	42	39	68	66	60	56	48	45	69	68	62	58	51	48	69	69	65	60	53	50	69	69	68	67	58	54						
	100	47	0.11	28	59	44	34	29	-	-	63	56	50	46	37	32	64	62	57	52	45	41	64	62	61	57	49	44	64	62	62	63	53	48	64	62	63	66	58	54						
	75	35	0.06	16	57	43	33	29	-	-	61	54	48	44	35	29	63	58	57	53	44	38	61	58	59	59	50	44	60	58	60	62	53	48	60	58	60	62	56	53						
5	400	189	0.19	48	62	57	56	61	53	48	67	64	65	64	54	49	71	68	70	67	56	51	73	70	72	69	58	53	75	72	73	70	59	55	76	74	75	71	62	58						
	300	142	0.11	28	61	54	51	55	46	41	67	64	62	60	49	44	70	69	65	63	52	48	73	70	67	64	54	51	74	72	69	66	56	53	75	74	71	68	59	57						
	250	118	0.05	12	59	50	47	49	40	34	65	63	57	55	44	40	69	67	61	58	48	45	71	70	63	61	51	48	72	71	65	63	54	51	73	72	68	66	58	55						
	200	94	0.05	13	58	46	42	42	32	26	65	61	53	50	40	36	68	64	57	55	45	42	69	67	60	58	49	46	70	68	63	60	52	50	71	69	66	65	56	54						
	125	59	0.02	5	57	42	31	27	-	-	63	52	47	44	34	30	64	58	54	50	41	38	65	60	59	55	46	42	65	60	61	62	50	46	65	60	63	67	59	53						
6	550	260	0.01	2	62	58	55	58	48	44	70	66	61	60	51	48	73	69	64	63	54	51	75	72	67	65	56	54	77	75	70	68	59	57	78	77	73	70	61	59						
	450	212	0.01	2	59	54	50	53	43	39	68	64	57	55	47	44	71	68	61	59	51	49	74	72	65	62	55	53	76	74	68	65	58	56	77	75	70	67	60	58						
	400	189	0.01	2	57	52	48	50	39	34	66	62	55	53	45	43	69	66	59	57	49	47	72	70	63	60	53	51	74	71	66	63	56	54	76	72	69	65	58	57						
	200	94	0.01	2	55	42	35	33	22	22	63	52	46	44	37	34	65	57	52	49	42	39	67	61	57	53	46	44	67	62	60	60	51	48	67	62	62	66	56	52						
	100	47	0.01	2	52	38	-	-	-	-	57	47	43	38	31	29	57	50	49	49	40	37	56	52	55	59	49	44	57	52	55	60	54	50	57	52	55	61	58	55						
7	800	378	0.01	2	67	62	61	61	53	48	71	66	65	63	55	50	74	69	67	65	57	54	77	72	70	68	60	57	79	75	73	70	62	59	81	78	76	73	65	62						
	650	307	0.01	2	63	58	55	56	47	42	69	64	60	58	51	47	72	68	64	62	55	51	76	72	68	65	58	55	78	76	71	67	61	58	80	76	73	70	63	61						
	550	260	0.01	2	59	54	51	51	42	36	66	61	57	55	49	46	70	65	61	59	52	49	74	70	65	62	55	53	76	71	68	65	59	56	78	73	71	67	61	59						
	335	158	0.01	2	57	47	42	40	31	28	64	56	52	50	44	40	68	60	56	54	48	44	71	64	61	58	51	48	71	66	64	62	55	52	72	67	67	67	59	56						
	225	106	0.01	2	52	40	39	35	26	21	60	50	48	44	37	34	61	54	53	51	44	40	63	58	58	58	51	46	63	58	60	60	55	51	64	59	61	62	58	55						
8	1100	519	0.01	2	71	67	66	65	57	53	73	69	68	66	58	53	76	72	71	68	61	56	78	74	73	70	63	59	81	77	76	73	66	62	84	80	79	76	69	65						
	900	425	0.01	2	67	63	60	59	51	46	71	66	64	62	55	51	74	70	67	65	58	54	77	73	71	68	61	58	80	76	74	70	64	61	82	78	76	73	67	63						
	700	330	0.01	2	62	58	54	52	44	38	67	63	59	57	52	49	71	67	63	61	55	52	76	71	67	65	58	55	78	74	70	67	62	58	79	77	73	70	65	62						
	600	283	0.01	2	59	54	50	48	40	33	65	61	57	55	51	47	70	66	61	59	54	50	75	70	65	63	57	53	76	73	68	65	60	56	77	75	71	67	63	59						
	400	189	0.01	2	52	43	39	35	26	21	62	55	52	50	43	39	66	61	57	54	48	44	69	66	61	58	53	49	70	67	64	61	56	52	70	68	68	64	59	56						
9	1400	661	0.01	2	71	65	67	65	59	54	75	69	70	68	60	55	78	72	72	71	62	57	80	74	75	73	64	60	82	77	77	75	67	63	84	79	79	77	70	66						
	1250	590	0.01	2	67	62	62	61	54	49	73	67	66	64	57	53	75	70	69	67	60	56	78	73	73	70	63	59	80	75	75	72	65	62	83	77	76	74	68	64						
	900	425	0.01	2	62	57	54	51	44	37	68	62	60	58	53	49	71	66	63	62	55	52	75	69	67	65	58	55	77	72	70	67	61	58	79	75	73	70	65	62						
	675	319	0.01	2	57	51	48	44	37	30	64	59	56	54	49	44	69	64	60	58	53	48	73	68	64	62	56	52	75	70	67	64	59	56	76	72	70	67	62	59						
	450	212	0.01	2	53	41	37	33	24	-	62	53	51	49	42	38	65	59	56	53	47	44	68	64	60	58	52	49	69	65	63	60	56	53	70	66	67	63	59	56						
10	1850	873	0.01	2	71	66	67	66	60	55	78	72	71	71	62	57	80	74	73	73	64	59	81	76	76	75	66	61	82	78	77	77	68	64	83	79	79	77	71	66						
	1650	779	0.01	2	68	63	64	63	56	51	75	69	68	67	59	54	77	72	71	70	62	57	79	75	74	72	64	60	81	77	75	74	66	63	83	79	78	76	69	65						
	1100	519	0.01	2	63	58	54	50	43	36	68	64	61	59	53	49	71	67	64	62	56	52	74	69	66	65	58	55	76	72	69	67	61	59	78	75	72	70	64	62						
	825	389	0.01	2	55	49	45	41	34	26	63	58	55	53	47	42	68	63	59	57	51	47	72	67	63	61	55	52	74	70	66	64	59	56	75	72	69	67	62	59						
	550	260	0.01	2	53	42	36	30	21	-	61	53	50	48	41	37	64	58	55	53	47	43	67	63	59	57	52	49	69	65	62	60	56	53	70	67	66	63	59	56						
12	2500	1180	0.01	2	67	61	66	65	60	54	78	70	71	70	63	57	80	73	73	73	65	60	81	75	76	75	67	62	83	77	78	77	70	66	85	79	79	79	73	69						
	2000	944	0.01	2	63	57	60	60	55	48	75	67	66	66	59	53	77	70	69	69	62	57	78	72	73	71	65	60	80	75	74	73	68	63	82	77	76	76	70	67						
	1600	755	0.01	2	59	51	54	53	47	40	71	64	62	61	55	50	74	67	66	65	58	54	76	70	69	68	62	58	78	73	71	70	65	61	79	75	73	72	67	65						
	1200	566	0.01	2	55	46	47	45	39	32	67	60	58	57	51	45	70	64	62	61	55	51	73	67	65	64	59	56	75	70	68	66	62													

Performance Data • Discharge Sound Power Levels

3000 Series • With 3 ft. (914) Integral Attenuator

Fiberglass Liner

A
SINGLE DUCT TERMINAL UNITS

Inlet Size	Airflow		Min. inlet ΔPs		Sound Power Octave Bands @ Inlet Pressure (ΔPs) shown																																			
					Minimum ΔPs					0.5" wg (125Pa) ΔPs					1.0" wg (250Pa) ΔPs					1.5" wg (375Pa) ΔPs					2.0" wg (500Pa) ΔPs					3.0" wg (750Pa) ΔPs										
					2	3	4	5	6	7	2	3	4	5	6	7	2	3	4	5	6	7	2	3	4	5	6	7	2	3	4	5	6	7	2	3	4	5	6	7
4	225	106	0.53	133	62	55	49	44	30	27	*	*	*	*	*	*	67	68	61	53	31	30	69	71	64	55	33	32	70	71	64	57	36	35	71	72	65	58	39	38
	200	94	0.43	106	62	53	47	42	27	27	64	65	58	53	31	28	66	68	59	52	32	31	69	71	62	55	35	35	70	71	63	56	35	36	70	72	66	59	37	37
	150	71	0.10	25	60	48	41	34	21	23	63	59	51	43	23	20	66	66	56	48	27	27	67	67	58	51	29	31	66	68	60	53	31	32	66	69	63	59	36	35
	100	47	0.11	28	58	41	26	-	-	-	62	56	47	39	21	-	64	61	53	44	27	26	63	60	56	47	29	27	63	60	57	51	31	30	64	61	58	53	34	34
	75	35	0.06	16	56	40	-	-	-	-	60	53	43	36	-	20	63	57	52	42	30	24	60	57	54	46	27	25	59	55	57	51	33	30	59	58	58	53	38	35
5	400	189	0.19	48	59	52	47	45	31	28	64	62	60	55	34	30	68	67	66	59	36	32	70	70	69	62	37	34	72	71	69	62	38	36	73	72	70	63	41	39
	300	142	0.11	28	59	49	42	39	24	22	64	64	57	52	30	26	67	69	61	55	33	31	70	70	63	57	35	35	71	72	65	58	36	35	72	73	67	60	37	37
	250	118	0.05	12	58	45	38	33	21	20	63	60	53	47	25	21	67	67	57	51	28	27	69	69	59	54	29	31	70	71	61	55	32	33	70	72	63	58	36	36
	200	94	0.05	13	57	43	34	-	-	24	64	61	50	43	24	23	68	63	53	47	27	27	68	65	55	48	29	29	70	67	58	48	30	31	71	68	61	52	32	34
	125	59	0.02	5	56	39	-	-	-	-	62	51	42	36	-	21	64	57	49	40	27	24	64	59	54	42	23	23	64	57	58	52	30	28	64	57	61	59	41	35
6	550	260	0.01	2	59	51	46	42	26	24	67	62	56	51	31	29	70	66	60	55	33	32	72	70	64	58	35	35	74	72	66	60	38	38	75	73	68	62	40	40
	450	212	0.01	2	57	47	41	37	21	20	65	62	52	47	28	26	68	66	57	51	32	32	71	70	61	55	36	37	73	71	64	57	37	38	74	72	66	59	38	38
	400	189	0.01	2	56	45	39	34	20	20	64	61	51	45	26	24	67	64	55	49	29	29	70	67	59	53	31	34	72	69	62	55	34	36	73	70	64	57	36	38
	200	94	0.01	2	54	37	27	-	-	20	62	50	43	37	21	21	65	54	48	40	24	24	66	57	52	43	26	27	67	58	55	48	29	30	67	59	57	53	32	32
	100	47	0.01	2	51	37	-	-	-	-	56	44	38	30	-	20	57	47	44	38	26	23	55	49	50	46	26	25	56	51	52	50	33	31	56	52	53	53	40	37
7	800	378	0.01	2	66	58	55	51	35	31	71	65	61	57	38	32	74	68	64	60	40	35	76	71	67	62	41	38	78	74	69	64	44	40	80	76	72	67	46	43
	650	307	0.01	2	62	54	49	46	29	25	69	64	57	52	34	29	72	67	60	56	37	33	75	71	64	59	40	38	77	73	67	62	42	40	79	75	70	64	44	41
	550	260	0.01	2	58	51	45	41	25	22	65	61	54	49	30	26	69	65	58	53	33	31	73	68	62	57	36	35	75	70	65	59	39	38	77	72	68	61	42	40
	335	158	0.01	2	56	45	37	35	26	20	63	55	48	43	26	23	67	59	53	47	30	27	70	63	57	50	33	31	70	64	60	54	36	34	71	65	63	58	39	37
	225	106	0.01	2	51	37	38	33	-	-	59	49	43	37	27	21	60	53	49	43	29	25	62	57	55	50	31	29	62	58	57	53	36	33	63	59	58	57	41	37
8	1100	519	0.01	2	70	66	63	61	43	37	72	68	65	63	44	35	75	70	68	65	46	38	77	72	70	67	48	40	80	76	72	69	50	43	83	79	75	71	53	46
	900	425	0.01	2	66	61	58	55	37	31	70	65	61	58	40	32	73	68	64	61	42	35	76	72	67	64	45	38	79	74	70	66	47	42	81	77	73	68	50	45
	700	330	0.01	2	61	57	52	48	31	23	66	61	56	52	35	28	70	66	60	56	38	32	75	70	64	60	42	36	77	72	68	63	45	39	78	74	71	65	48	43
	600	283	0.01	2	58	53	47	43	26	-	64	59	53	50	31	25	69	64	58	54	36	30	74	68	62	58	40	36	75	70	65	60	43	39	76	71	69	63	46	42
	400	189	0.01	2	51	40	38	33	-	-	61	55	48	44	27	22	65	60	54	49	32	27	68	65	59	53	37	32	69	65	62	57	40	35	69	65	64	61	43	38
9	1400	661	0.01	2	70	62	63	58	43	40	74	69	66	63	45	39	77	71	68	65	47	41	79	73	70	67	49	44	81	76	72	69	51	46	84	78	75	71	53	49
	1250	590	0.01	2	66	59	59	55	39	36	72	64	63	59	42	37	74	70	66	62	44	39	77	72	69	64	46	42	79	75	71	66	48	45	82	77	73	68	51	47
	900	425	0.01	2	61	55	49	45	28	23	67	61	56	51	35	30	70	65	59	55	38	34	74	69	63	58	41	38	76	71	66	60	44	41	78	73	69	63	47	44
	675	319	0.01	2	56	49	43	38	23	20	64	58	52	47	30	25	69	62	56	51	35	31	73	66	60	55	39	36	75	68	63	57	42	39	75	71	67	60	45	43
	450	212	0.01	2	52	41	34	28	-	-	61	53	47	42	25	22	64	58	52	46	30	27	67	63	57	51	35	33	68	64	60	54	38	36	69	65	63	57	41	38
10	1850	873	0.01	2	71	66	62	56	43	43	77	71	66	63	46	43	78	72	69	65	48	45	80	74	71	67	49	47	81	76	73	68	51	49	83	77	74	70	53	51
	1650	779	0.01	2	67	60	60	54	40	41	75	66	65	60	43	41	77	72	67	63	45	43	78	73	70	65	48	45	81	75	71	67	49	48	82	77	73	68	51	50
	1100	519	0.01	2	61	53	46	41	26	23	66	61	56	50	35	32	69	64	59	53	38	36	72	67	62	56	40	39	74	70	64	58	43	42	76	72	67	60	46	45
	825	389	0.01	2	54	46	39	33	20	20	61	56	50	44	29	26	65	60	54	48	33	31	69	64	58	52	37	36	71	67	61	54	40	39	72	70	65	57	43	43
	550	260	0.01	2	50	38	30	-	-	-	58	51	45	39	24	22	62	56	50	43	29	28	65	61	55	48	34	33	66	63	58	51	37	36	67	64	61	54	40	39
12	2500	1180	0.01	2	65	59	59	55	41	41	78	69	66	63	46	44	79	71	69	64	48	46	81	73	72	66	50	49	82	75	73	68	53	52	83	76	75	70	56	55
	2000	944	0.01	2	62	56	53	49	35	35	74	66	62	57	41	39	75	68	65	60	44	43	77	70	68	63	48	47	78	72	70	65	50	47	80	74	72	66	53	53
	1600	755	0.01	2	59	51	47	43	29	27	69	63	58	52	37	36	71	65	61	56	41	40	74	67	64	59	44	44	75	70	67	61	47	47	77	73	69	63	50	50
	1200	566	0.01	2	52	45	41	35	22	22	64	58	54	48	33	31	68	61	57	51	37	36	71	65	60	55	41	42	73	67	63	57	44	45	74	70				

Performance Data • Radiated Sound Power Levels

3000 Series • Basic Unit

Fiberglass Liner



Inlet Size	Airflow		Min. inlet ΔPs		Sound Power Octave Bands @ Inlet Pressure (ΔPs) shown																																									
					Minimum ΔPs							0.5" wg (125Pa) ΔPs							1.0" wg (250Pa) ΔPs							1.5" wg (375Pa) ΔPs							2.0" wg (500Pa) ΔPs							3.0" wg (750Pa) ΔPs						
					2	3	4	5	6	7	2	3	4	5	6	7	2	3	4	5	6	7	2	3	4	5	6	7	2	3	4	5	6	7	2	3	4	5	6	7						
4	225	106	0.53	133	-	37	33	33	-	-	*	*	*	*	*	*	51	48	45	38	32	30	55	54	49	42	33	32	55	55	51	44	35	33	56	57	54	48	39	38						
	200	94	0.43	106	-	36	33	32	-	-	-	39	37	38	29	29	49	46	43	37	30	29	53	52	47	40	32	31	53	53	50	42	33	33	54	55	53	47	37	37						
	150	71	0.10	25	-	35	29	31	-	-	-	40	36	30	25	23	47	46	40	34	28	26	49	50	47	39	31	30	47	48	48	43	34	32	48	48	48	50	40	37						
	100	47	0.11	28	-	-	-	-	-	-	-	37	32	27	-	-	-	43	42	34	27	23	-	44	45	41	32	29	-	43	46	46	36	32	-	42	44	51	43	38						
	75	35	0.06	16	-	-	-	-	-	-	-	37	31	26	-	-	-	41	43	37	29	24	-	42	45	42	32	29	-	38	42	45	40	33	-	36	41	48	44	40						
5	400	189	0.19	48	49	41	34	36	34	27	52	45	40	40	39	36	56	48	45	38	37	34	60	52	49	40	39	34	63	56	51	42	40	36	63	59	56	45	44	40						
	300	142	0.11	28	47	38	32	32	30	27	50	43	37	35	33	31	54	46	44	37	35	31	57	49	47	39	38	33	59	52	49	40	39	35	59	55	53	43	43	39						
	250	118	0.05	12	-	35	31	25	23	-	50	40	36	32	30	25	54	45	42	33	32	28	55	48	45	35	35	30	56	51	48	37	37	32	57	53	51	42	41	35						
	200	94	0.05	13	-	-	-	-	-	-	50	38	34	27	25	-	52	43	39	31	30	25	52	45	43	32	32	28	53	48	46	36	36	30	53	48	48	44	41	34						
	125	59	0.02	5	-	-	-	-	-	-	-	33	29	21	-	-	48	40	38	28	27	-	48	42	42	34	33	27	49	42	44	39	38	29	49	42	44	47	46	37						
6	550	260	0.01	2	48	47	41	39	31	29	49	48	42	41	35	31	57	52	46	41	35	32	62	55	49	45	36	34	64	58	51	45	40	38	67	61	56	48	44	43						
	450	212	0.01	2	48	44	37	35	30	28	48	47	40	38	32	29	56	50	45	40	34	31	59	53	48	44	36	33	61	55	50	43	39	37	64	58	54	46	42	41						
	400	189	0.01	2	-	42	33	33	28	26	49	46	39	35	30	28	56	49	44	38	32	29	59	52	47	40	36	33	62	54	49	42	39	36	64	58	54	45	42	41						
	200	94	0.01	2	-	-	-	-	-	-	47	36	30	24	-	-	53	43	38	30	29	28	53	45	43	32	31	30	53	47	44	36	32	32	55	49	46	43	37	37						
	100	47	0.01	2	-	-	-	-	-	-	-	34	27	-	-	-	-	35	38	33	29	24	45	39	40	37	31	28	47	39	40	42	37	32	46	40	40	46	44	38						
7	800	378	0.01	2	50	47	51	37	36	36	50	48	45	37	33	33	57	52	48	40	34	32	63	58	53	46	38	35	68	62	56	49	40	38	70	66	61	54	45	42						
	650	307	0.01	2	49	45	46	38	31	30	49	48	45	37	31	29	54	50	47	40	34	32	60	54	50	44	37	35	64	58	54	48	40	38	67	63	58	51	44	43						
	550	260	0.01	2	48	43	41	33	27	25	48	44	40	32	28	26	55	49	45	38	32	30	61	54	49	43	36	33	64	58	52	45	38	36	65	61	57	50	42	40						
	335	158	0.01	2	-	-	28	33	-	-	-	40	35	29	24	-	52	48	42	36	30	28	57	51	46	40	32	30	57	52	48	42	34	32	57	53	50	47	39	38						
	225	106	0.01	2	-	-	-	-	-	-	-	39	33	28	-	-	50	45	40	34	28	25	52	47	43	38	31	29	51	47	43	41	33	31	52	48	45	42	35	36						
8	1100	519	0.01	2	52	50	45	37	34	33	57	51	46	37	35	32	60	54	51	40	38	33	65	57	53	43	42	36	67	60	56	45	44	39	70	63	60	49	48	42						
	900	425	0.01	2	51	47	40	34	31	29	56	50	45	37	34	31	58	53	49	39	37	33	63	56	51	42	42	36	65	58	54	44	44	39	68	60	56	47	48	42						
	700	330	0.01	2	50	43	37	31	29	25	51	47	42	33	31	28	57	51	47	37	36	32	61	53	50	40	39	35	63	55	51	42	41	37	64	59	56	45	44	40						
	600	283	0.01	2	-	39	33	29	26	-	50	45	40	31	30	26	57	49	45	35	34	31	60	53	49	38	38	33	61	55	51	40	40	36	63	59	56	44	43	40						
	400	189	0.01	2	-	35	26	-	-	-	49	41	36	28	27	24	54	47	41	32	31	30	57	52	46	35	34	32	57	52	47	37	36	34	59	54	51	41	40	39						
9	1400	661	0.01	2	51	46	46	44	37	35	52	47	46	41	38	35	57	53	49	42	37	35	64	58	53	47	41	37	66	63	57	50	43	40	69	67	61	54	47	44						
	1250	590	0.01	2	51	46	45	42	35	35	51	46	46	41	37	34	56	52	48	42	36	34	63	57	52	46	40	37	65	62	56	50	43	40	68	65	60	53	46	44						
	900	425	0.01	2	48	40	39	36	30	29	50	45	42	37	32	30	56	50	45	40	35	33	60	54	49	44	39	36	63	58	52	47	41	38	64	61	56	50	44	42						
	675	319	0.01	2	47	37	31	29	22	-	49	41	36	31	28	25	55	48	42	37	32	30	58	52	46	41	35	33	60	56	50	44	38	36	60	57	52	47	41	39						
	450	212	0.01	2	-	-	24	-	-	-	48	40	33	30	26	24	53	46	39	34	30	29	54	49	43	38	33	31	55	50	46	41	35	34	56	52	48	45	39	38						
10	1850	873	0.01	2	57	47	48	40	36	27	58	49	48	40	37	31	60	55	52	45	39	35	64	59	56	50	43	39	65	62	57	52	46	42	68	66	61	56	49	46						
	1650	779	0.01	2	55	45	45	40	35	26	57	49	46	39	36	30	59	54	51	44	38	34	63	58	55	49	42	38	64	60	56	51	45	41	67	65	60	55	48	45						
	1100	519	0.01	2	51	37	35	30	25	-	53	46	42	35	31	27	55	50	47	41	35	31	60	54	50	45	39	36	61	56	51	47	42	39	64	61	55	51	45	43						
	825	389	0.01	2	-	33	29	25	-	-	50	43	38	32	29	25	55	48	43	38	33	30	58	52	47	42	37	34	59	54	49	44	39	37	61	57	53	49	43	41						
	550	260	0.01	2	-	-	-	-	-	-	-	38	33	29	25	-	51	44	38	34	30	28	53	47	42	38	34	32	56	50	45	41	36	35	57	52	48	45	40	38						
12	2500	1180	0.01	2	57	55	54	50	42	36	60	57	53	46	41	38	63	61	54	50	42	39	66	63	57	53	45	41	67	64	59	55	48	44	70	69	63	59	52	50						
	2000	944	0.01	2	54	50	48	44	37	33	58	55	51	46	39	35	61	59	53	49	42	37	64	61	56	52	45	41	65	62	58	55	48	44	68	66	61	58	51	49						
	1600	755	0.01	2	52	45	41	36	30	27	56	52	45	40	34	30	59	56	49	46	38	35	61	58	53	49	42	39	62	60	55	51	44	42	65	64	58	55	48	46						
	1200	566	0.01	2	47	39	33	29	24	-	52	48	40	36	30	27	55	52	45	41	34	32	58	55	49	45	38	36	60	58	51	48	41	39	61	61	55	52	45	44						
	800	378	0.01	2	-	-	-	-	-	-	50	41	34	30	26	-	52	48	41	37	31	30																								

Performance Data • AHRI Certification and Performance Notes

3000 Series • Basic Unit • AHRI Certification Rating Points

Fiberglass Liner

Inlet Size	Airflow		Min. Inlet ΔPs		Discharge Sound Power Levels @ 1.5" w.g. (375 Pa) ΔPs							Radiated Sound Power Levels @ 1.5" w.g. (375 Pa) ΔPs						
					Octave Band							Octave Band						
	cfm	l/s	"w.g.	Pa	2	3	4	5	6	7	2	3	4	5	6	7		
4	150	71	0.10	25	69	68	62	58	51	48	49	50	47	39	31	30		
5	250	118	0.05	12	71	70	63	61	51	48	55	48	45	35	35	30		
6	400	189	0.01	2	72	70	63	60	53	51	59	52	47	40	36	33		
7	550	260	0.01	2	74	70	65	62	55	53	61	54	49	43	36	33		
8	700	330	0.01	2	76	71	67	65	58	55	61	53	50	40	39	35		
9	900	425	0.01	2	75	69	67	65	58	55	60	54	49	44	39	36		
10	1100	519	0.01	2	74	69	66	65	58	55	60	54	50	45	39	36		
12	1600	755	0.01	2	76	70	69	68	62	58	61	58	53	49	42	39		
14	2100	991	0.01	2	75	70	71	70	64	60	63	61	55	48	44	43		
16	2800	1321	0.02	5	76	70	68	67	62	58	65	63	57	50	44	39		
24 x 16	5350	2525	0.01	2	87	81	79	76	72	69	72	70	70	65	60	55		



Ratings are certified in accordance with AHRI Standards.

Performance Notes for Sound Power Levels:

- Discharge sound power is the noise emitted from the unit discharge into the downstream duct. Discharge Sound Power Levels (SWL) now include duct end reflection energy as part of the standard rating. Including the duct end correction provides sound power levels that would normally be transmitted into an acoustically, non-reflective duct. The effect of including the energy correction to the discharge SWL, is higher sound power levels when compared to previous AHRI certified data. For more information on duct end reflection calculations see AHRI Standard 880.
- Radiated sound power is the breakout noise transmitted through the unit casing walls.
- Sound power levels are in decibels, dB re 10⁻¹² watts.
- All sound data listed by octave bands is raw data without any corrections for room absorption or duct attenuation. Dash (-) in space indicates sound power level is less than 20 dB or equal to background.
- Minimum inlet ΔPs is the minimum operating pressure requirement of the unit (damper full open) and the difference in static pressure from inlet to discharge of the unit.
- Asterisk (*) in space indicates that the minimum inlet static pressure requirement is greater than 0.5" w.g. (125 Pa) at rated airflow.
- Data derived from independent tests conducted in accordance with ANSI/ASHRAE Standard 130 and AHRI Standard 880.

A

SINGLE DUCT TERMINAL UNITS

3000Q SERIES • QUIET TYPE WITH DISSIPATIVE SILENCER PRODUCT OVERVIEW



Nailor 3000Q Series Quiet Terminal units control the flow of conditioned primary air into a constant or variable air volume (VAV) HVAC system at exceptionally quiet levels. There are three versions of the 3000Q series: the standard cooling unit (3001Q), a cooling with water reheat unit (30RWQ) and a cooling unit with electric reheat (30REQ). Each unit includes a VAV terminal and factory installed dissipative silencer providing an assembly ideal for use in sound sensitive environments like libraries, performance halls, classrooms, conference rooms, studios and hospitals.

The 3000Q Series shares design features with the 3000 Series terminal units like the opposed blade damper (OBD), rectangular discharge, multi-point averaging Diamond Flow Sensor and various control options. The VAV and silencer assembly is designed to provide minimal impact on system pressure drop while concurrently delivering superior sound attenuation.

Each dissipative silencer is constructed with internal baffle (an acoustic absorption media) and is internally insulated. The baffles are made of perforated steel and are designed with elliptical nose pieces to transition air into and out of the silencer. Arranged inside the silencer as side pods, the baffles act to attenuate discharge sound using an acoustical media placed between the silencer casing and the baffle. Internal (top and bottom) panels exposed to the airstream are insulated with fiberglass and as a result, field installed externally wrapped insulation is not needed.

Of the three available types of media, the standard is a simple fiberglass fill which provides exceptional attenuation. When IAQ is a concern, the fiberglass can be wrapped in a woven fiberglass cloth to prevent erosion and entrainment of fibers into the airstream. Since the fiberglass cloth is porous moisture can penetrate the underlying fiberglass. There is also an option that wraps the fiberglass with Mylar, designed primarily for environments where fiberglass isolation is paramount.

In the past, selecting a silencer to mate with a VAV terminal involved multiple calculations, guesswork and an intimate knowledge of silencer performance. The engineer or contractor had to contend with pressure classes, sizes and free area to balance the associated pressure drop, attenuation and self generated noise against the VAV terminal performance. Even after careful selection, the result was still a guess due to the unknown system effect created by the close coupled terminal/silencer assembly. Since each 3000Q Series unit is designed, manufactured and tested as a complete assembly, the guesswork is eliminated.

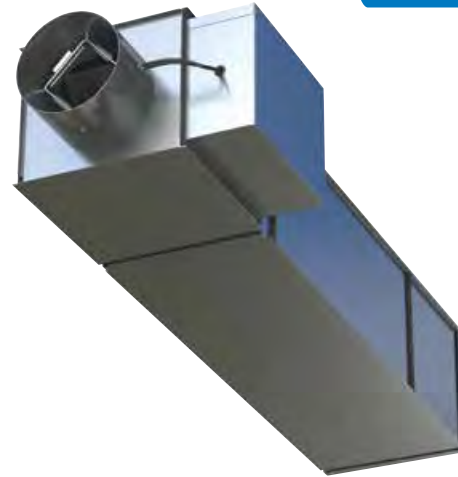

3001Q Cooling or Heating only

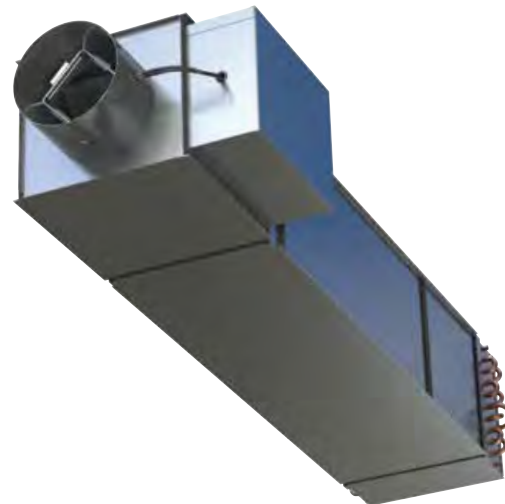

30RWQ Cooling with Hot Water Reheat



30REQ Cooling with Electric Reheat

SINGLE DUCT VARIABLE OR CONSTANT AIR VOLUME

3000Q SERIES

- QUIET
- DISSIPATIVE SILENCER

Models:

- 3001Q** Cooling or Heating only
- 30RWQ** Cooling with Hot Water Reheat
- 30REQ** Cooling with Electric Reheat

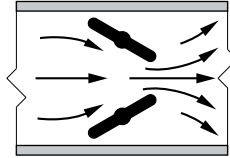

Inclined opposed blade damper configuration minimizes noisy turbulence and provides smooth, accurate, near linear flow control.

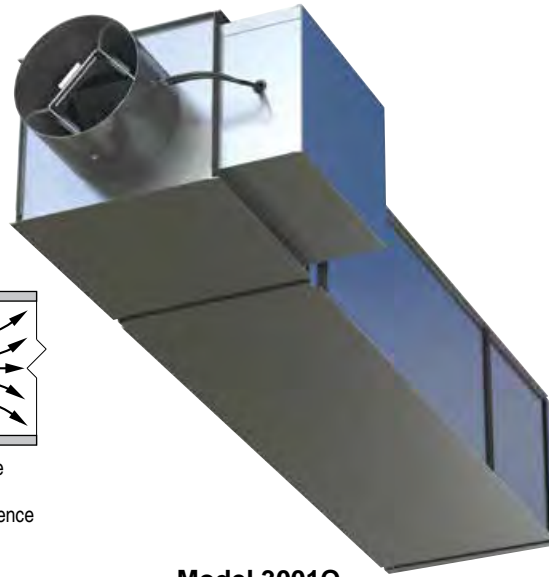

Model 3001Q

3000Q Series Quiet terminal units are used in noise sensitive applications such as libraries, studios, performance halls, classrooms, conference rooms and hospitals. The integral dissipative silencer minimizes pressure loss, reduces self-generated sound and maximizes acoustical attenuation, providing an extremely quiet terminal without the addition of downstream acoustic insulation. Model 3000Q Series are available with electric or hot water reheat as well as options like removable flow sensors and access doors. Each unit is available with multiple insulation types, ranging from standard fiberglass to IAQ types.

STANDARD FEATURES:

- Designed for noise sensitive applications such as classrooms, libraries, studios and performance halls.
- 22 ga. (0.86) galvanized steel casing, mechanically sealed, low leakage construction.
- 16 ga. (1.63) corrosion-resistant steel inclined opposed blade damper with extruded PVC seals (single blade on size 4, 5, 6). 45° rotation, CW to close. Tight shut-off. Damper leakage is less than 2% of the terminal rated airflow at 3" w.g. (746 Pa).
- 1/2" (13) dia. plated steel drive shaft. An indicator mark on the end of the shaft shows damper position.
- Multi-point averaging Diamond Flow Sensor. Aluminum construction. Supplied with balancing tees.
- Rectangular discharge with slip and drive cleat duct connection.
- Full NEMA 1 type controls enclosure for factory mounted controls.
- VAV section is lined with 3/4" (19), dual density insulation, exposed

edges coated to prevent air erosion. Meets the requirements of NFPA 90A and UL 181.

- Right-hand controls location is standard (shown) when looking in direction of airflow. Optional left hand controls mounting is available. Unit is flippable. Caution: If unit has access door.
- Available in 11 sizes ranging from 0 to 8300 cfm (0-3917 l/s) for 3001Q and 30RWQ units. 25-8300 cfm (12-3917 l/s) on 30REQ.

Silencer Section:

- Designed to mate with VAV section for optimum performance and ultra quiet operation.
- Optimized internal baffle geometry reduces self-generated noise, maximizes acoustic attenuation.
- 22 ga. (0.86) coated steel perforated baffles encapsulate fiberglass acoustic media.
- Internal insulation on top and bottom exposed panels optimizes sound reduction and eliminates need for external field applied thermal duct wrap.

Options and Accessories:

- Bottom access door.
- Removable insert type Diamond Flow Sensor.
- 24 VAC control transformer.
- Toggle disconnect switch.
- Hanger brackets.
- Controls enclosure for field or factory mounted controls.
- Dust tight enclosure seal.
- 20 ga. (1.00) construction.
- Multiple VAV liners.
- IAQ Acoustic liners available on dissipative silencer.
- Seismic certification.
- Oversized casing.



Intertek

Dimensions

Model 3001Q • Quiet • Dissipative Silencer

Digital and Analog Electronic Controls

- A full NEMA 1 controls enclosure is provided for factory mounted controls. Optional for field mounted controls.

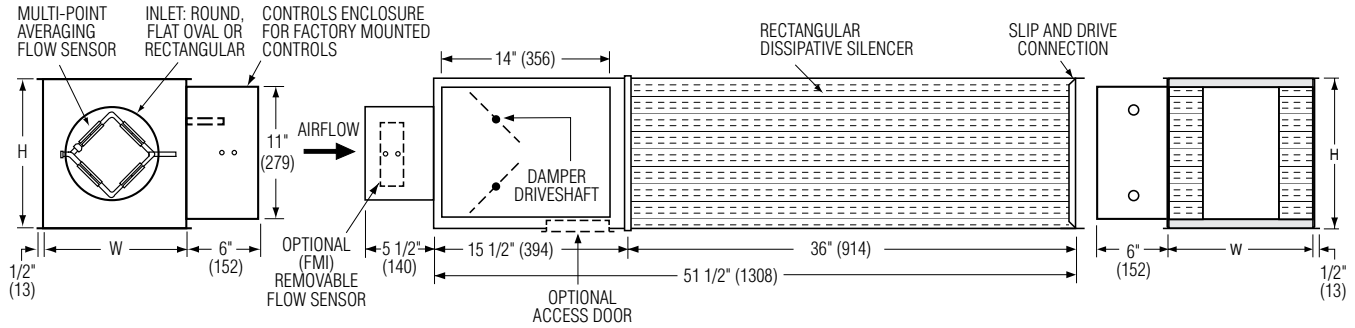

Pneumatic Controls

- Universal pneumatic control mounting panel features double wall stand-off construction for strength and rigidity. Controls mounting screws do not penetrate terminal casing.

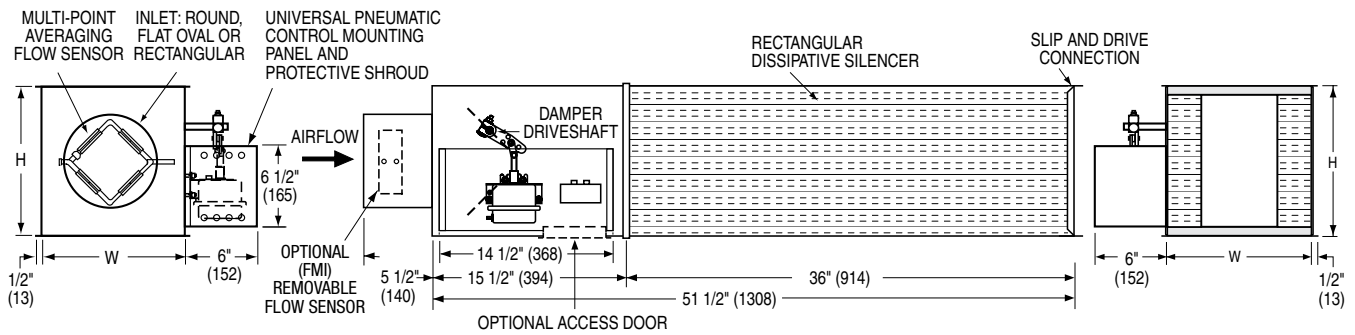

Dimensional Data

Unit Size	W	H	Inlet Size
4	10 (254)	10 (254)	3 7/8 (98) Round
5	10 (254)	10 (254)	4 7/8 (124) Round
6	10 (254)	10 (254)	5 7/8 (149) Round
7	12 (305)	12 1/2 (318)	6 7/8 (175) Round
8	12 (305)	12 1/2 (318)	7 7/8 (200) Round
9	14 (356)	12 1/2 (318)	8 7/8 (225) Round
10	14 (356)	12 1/2 (318)	9 7/8 (251) Round
12	18 (457)	12 1/2 (318)	12 15/16 x 9 13/16 (329 x 249) Oval
14	24 (610)	12 1/2 (318)	16 1/16 x 9 13/16 (408 x 249) Oval
16	28 (711)	12 1/2 (318)	19 3/16 x 9 13/16 (487 x 249) Oval
24 x 16	38 (965)	18 (457)	23 7/8 x 15 7/8 (606 x 403) Rect.

Dimensions

Model 30RWQ • Quiet • Dissipative Silencer • Hot Water Reheat Coil

- One, two, three and four row available.
- Hot water coils have 1/2" (13) copper tubes and aluminum ripple fins, 10 per inch.
- Coils have 1/2" (13), 7/8" (22) or 1 3/8" (35) O.D. sweat connections.
- Galvanized steel casing with slip and drive discharge duct connection.
- Optional low leakage gasketed access door is recommended for coil access and cleaning.
- AHRI Certified coils.
- Coil Performance data on pages A43-A51.
- Oversized casing option on pages A40-A42.

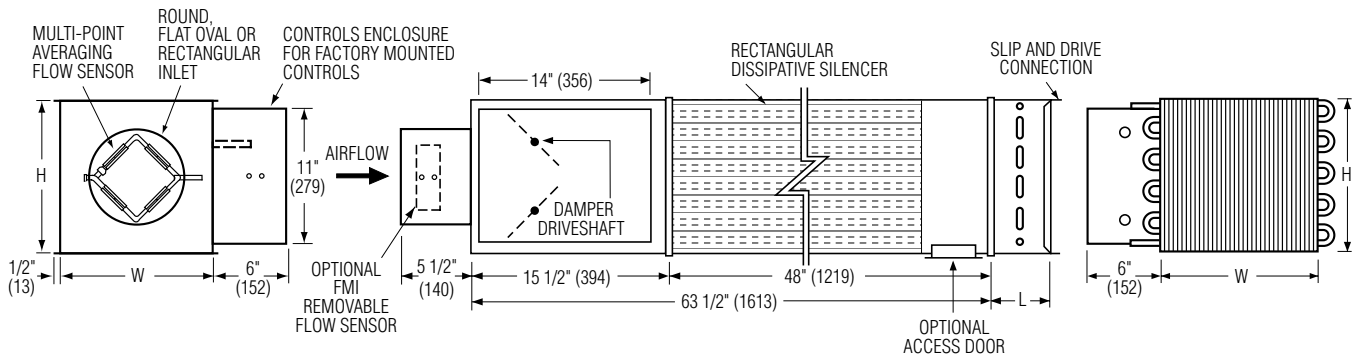

Right or left hand coil connection is determined by looking through the terminal inlet in the direction of airflow.

30REQ • Integral Electric Reheat

- Electric coil is factory mounted in an integral extended plenum section.
- Full details and selection guide on page A52.

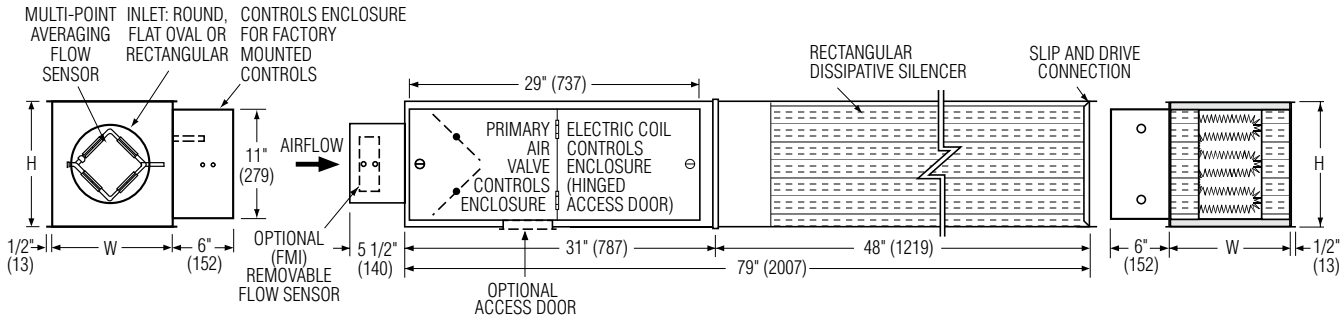

Dimensional Data

Unit Size	W	H	Inlet Size	Coil Connections			Hot Water Coil	
				1 Row	2 Row	3 & 4 Row	L (1 & 2 Row)	L (3 & 4 Row)
4	10 (254)	10 (254)	3 7/8 (98) Round	1/2 (13)	7/8 (22)	7/8 (22)	5 (127)	7 1/2 (191)
5	10 (254)	10 (254)	4 7/8 (124) Round	1/2 (13)	7/8 (22)	7/8 (22)	5 (127)	7 1/2 (191)
6	10 (254)	10 (254)	5 7/8 (149) Round	1/2 (13)	7/8 (22)	7/8 (22)	5 (127)	7 1/2 (191)
7	12 (305)	12 1/2 (318)	6 7/8 (175) Round	1/2 (13)	7/8 (22)	7/8 (22)	5 (127)	7 1/2 (191)
8	12 (305)	12 1/2 (318)	7 7/8 (200) Round	1/2 (13)	7/8 (22)	7/8 (22)	5 (127)	7 1/2 (191)
9	14 (356)	12 1/2 (318)	8 7/8 (225) Round	1/2 (13)	7/8 (22)	7/8 (22)	5 (127)	7 1/2 (191)
10	14 (356)	12 1/2 (318)	9 7/8 (251) Round	1/2 (13)	7/8 (22)	7/8 (22)	5 (127)	7 1/2 (191)
12	18 (457)	12 1/2 (318)	12 15/16 x 9 13/16 (329 x 249) Oval	1/2 (13)	7/8 (22)	7/8 (22)	5 (127)	7 1/2 (191)
14	24 (610)	12 1/2 (318)	16 1/16 x 9 13/16 (408 x 249) Oval	1/2 (13)	7/8 (22)	7/8 (22)	5 (127)	7 1/2 (191)
16	28 (711)	12 1/2 (318)	19 3/16 x 9 13/16 (487 x 249) Oval	7/8 (22)	7/8 (22)	7/8 (22)	5 (127)	7 1/2 (191)
24 x 16	38 (965)	18 (457)	23 7/8 x 15 7/8 (606 x 403) Rect.	7/8 (22)	7/8 (22)	1 3/8 (35)	5 (127)	7 1/2 (191)

A SINGLE DUCT TERMINAL UNITS

Options:

FMI Removable Flow Sensor

The (FMI) Removable Flow Sensor is a multi-point averaging airflow sensor. Designed to provide accurate sensing by sampling air velocities in four quadrants of a duct, the differential pressure flow sensor provides an averaged reading at an amplification of approximately 2.5 times the velocity pressure, dependent upon nominal size.

Features:

- Removable for cleaning.
- All metal construction - no combustible materials in the air stream.
- Amplifies velocity pressure approximately 2.5 times to give a wide range of useful output signal vs. flow.
- Compact size allows for easy removal in tight spaces.
- Sensor design minimizes pressure drop and regenerated noise.
- Label provided on each unit gives airflow direction.
- Multi-point sensing gives an accurate output signal with a maximum deviation of only $\pm 5\%$ with a hard 90 degree elbow, provided a straight inlet condition with a minimum length of two equivalent duct diameters is provided.

Round or Flat Oval Inlet

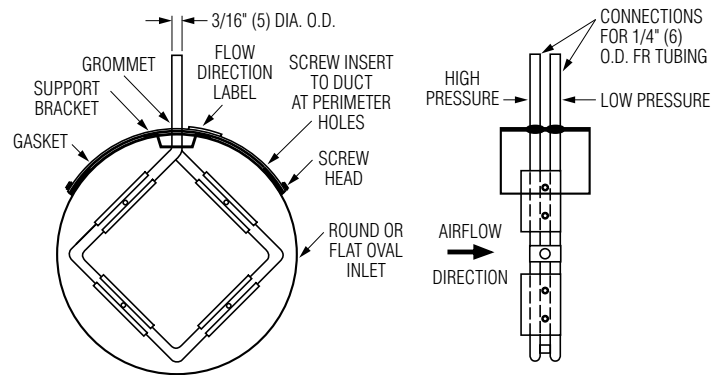

Rectangular Inlet

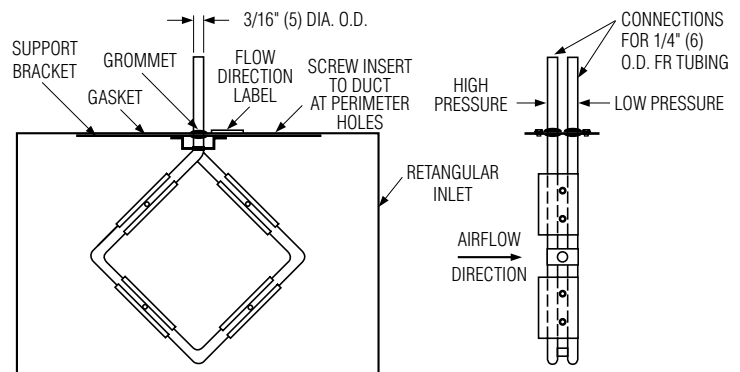

Access Door

Ultra-low leakage, premium quality and performance. Flat oval design.

- Die formed 22 ga. (0.86) galvanized steel flanged and door panel.
- Positive bulb door seal.
- Plated steel camlock fasteners.
- 1" (25) insulation with 22 ga. (0.86) galvanized backing plate.
- Leakage tested in conformance with British Standard DW/142 Class C.
- See 0800-1 submittal for more detailed information.

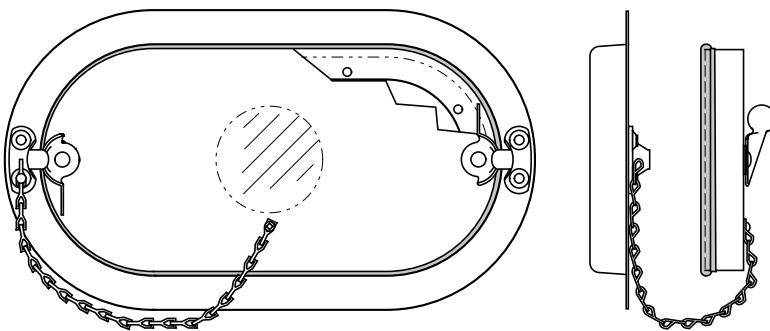

Terminal Unit Size	Nominal Door Size	Max. Leakage 8" w.g. (2 kPa) cfm
4 - 12	8" x 5" (203 x 127)	0.036 cfm (1.02 l/min.)
14 - 24 x 16	12" x 6" (305 x 152)	0.064 cfm (1.8 l/min.)

Recommended Airflow Ranges For Single Duct Terminal Units

The recommended airflow ranges below are for 3000Q Series single duct terminal units with pressure independent controls and are presented as ranges for total and controller specific minimum and maximum airflow. Airflow ranges are based upon maintaining reasonable sound levels and controller limits using Nailor's Diamond Flow Sensor as the airflow measuring device. For a given unit size, the minimum, auxiliary minimum (where applicable) and the maximum flow setting must be within the range limits to ensure pressure independent operation, accuracy and repeatability.

Minimum airflow limits are based upon .02" w.g. (5 Pa) differential pressure signal from Diamond Flow Sensor on analog/digital controls and .03" (7.5) for pneumatic controllers. This is a realistic low limit for many transducers used in the digital controls industry. Check your controls supplier for minimum limits. Setting airflow minimums lower, may cause damper hunting and result in a failure to meet minimum ventilation requirements. Factory settings will therefore not be made outside these ranges; however, a minimum setting of zero (shut-off) is an available option on pneumatic units. Where an auxiliary setting is specified, the value must be greater than the minimum setting.

The high end of the tabulated Total Airflow Range on pneumatic and analog electronic controls represents the Diamond Flow Sensor's differential pressure reading at 1" w.g. (250 Pa). The high end airflow range for digital controls is represented by the indicated transducer differential pressure.

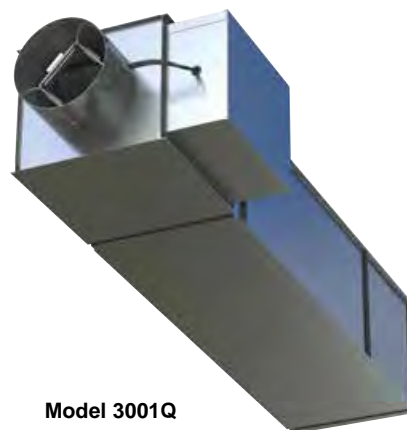

Model 3001Q

ASHRAE 130 "Performance Rating of Air Terminals" is the method of test for the certification program. The "standard rating condition" (certification rating point) airflow volumes for each terminal unit size are tabulated below per AHRI Standard 880. These air volumes equate to an approximate inlet velocity of 2000 fpm (10.2 m/s).

When digital or other controls are mounted by Nailor, but supplied by others, these values are guidelines only, based upon experience with the majority of controls currently available. Controls supplied by others for factory mounting are configured and calibrated in the field. Airflow settings on pneumatic and analog controls supplied by Nailor are factory preset when provided.

Imperial Units, Cubic Feet per Minute

Unit Size	Inlet Type	Total Airflow Range, cfm	Airflow at 2000 fpm Inlet Velocity (nom.), cfm	Range of Minimum and Maximum Settings, cfm							
				Pneumatic 3000 Controller		Analog Electronic Controls		Digital Controls			
				Transducer Differential Pressure ("w.g.)							
				Min.	Max.	Min.	Max.	Min.	Max.		
				.03	1.0	.02	1.0	.02	1.0	1.25	1.5
4	Round	0 – 225	150	30	180	25	180	25	180	200	225
5		0 – 400	250	55	325	45	325	45	325	360	400
6		0 – 550	400	80	450	65	450	65	450	500	550
7	Round	0 – 800	550	115	650	95	650	95	650	725	800
8		0 – 1100	700	155	900	125	900	125	900	1000	1100
9		0 – 1400	900	200	1150	165	1150	165	1150	1285	1400
10		0 – 1840	1100	260	1500	215	1500	215	1500	1675	1840
12	Flat Oval	0 – 2500	1600	355	2050	290	2050	290	2050	2300	2500
14		0 – 3125	2100	440	2550	360	2550	360	2550	2850	3125
16		0 – 3725	2800	525	3040	430	3040	430	3040	3400	3725
24 x 16	Rect.	0 – 8330	5350	1180	6800	960	6800	960	6800	7600	8330

Metric Units, Liters per Second

Unit Size	Inlet Type	Total Airflow Range, l/s	Airflow at 10.2 m/s Inlet Velocity (nom.), l/s	Range of Minimum and Maximum Settings, l/s							
				Pneumatic 3000 Controller		Analog Electronic Controls		Digital Controls			
				Transducer Differential Pressure (Pa)							
				Min.	Max.	Min.	Max.	Min.	Max.		
				7.5	249	5	249	5	249	311	374
4	Round	0 – 106	71	14	85	12	85	12	85	94	106
5		0 – 189	118	26	153	21	153	21	153	170	189
6		0 – 260	189	38	212	31	212	31	212	236	260
7	Round	0 – 378	260	54	307	45	307	45	307	342	378
8		0 – 519	330	73	425	59	425	59	425	472	519
9		0 – 661	425	94	543	78	543	78	543	606	661
10		0 – 868	519	123	708	101	708	101	708	790	868
12	Flat Oval	0 – 1180	755	168	967	137	967	137	967	1085	1180
14		0 – 1475	991	208	1203	170	1203	170	1203	1345	1475
16		0 – 1758	1321	248	1435	203	1435	203	1435	1604	1758
24 x 16	Rect.	0 – 3931	2525	557	3209	453	3209	453	3209	3586	3931

A SINGLE DUCT TERMINAL UNITS

Performance Data • NC Level Application Guide

3000Q Series • Quiet • Dissipative Silencer

Fiberglass Acoustic Media (FAM)

Inlet Size	Airflow cfm l/s		Min. inlet ΔPs "w.g. Pa		NC Levels @ Inlet Pressure (ΔPs) shown											
					DISCHARGE					RADIATED						
					Min. ΔPs	0.5" w.g. (125 Pa)	1.0" w.g. (250 Pa)	1.5" w.g. (375 Pa)	2.0" w.g. (500 Pa)	3.0" w.g. (750 Pa)	Min. ΔPs	0.5" w.g. (125 Pa)	1.0" w.g. (250 Pa)	1.5" w.g. (375 Pa)	2.0" w.g. (500 Pa)	3.0" w.g. (750 Pa)
4	200	94	0.38	94	-	-	-	21	20	21	-	-	-	21	24	28
	150	71	0.23	57	-	-	-	-	-	-	-	-	-	21	22	22
	100	47	0.11	28	-	-	-	-	-	-	-	-	-	-	20	23
	50	24	0.04	11	-	-	-	-	-	-	-	-	-	-	-	-
5	350	165	0.17	41	-	-	20	24	24	28	-	-	-	23	25	30
	250	118	0.08	20	-	-	23	25	25	26	-	-	-	-	22	25
	150	71	0.03	7	-	-	-	-	-	-	-	-	-	-	-	20
	100	47	0.02	5	-	-	-	-	-	-	-	-	-	-	-	-
6	500	236	0.05	13	-	-	-	21	21	26	-	-	20	23	26	30
	400	189	0.04	10	-	-	-	20	20	23	-	-	-	21	25	29
	300	142	0.03	6	-	-	-	-	-	-	-	-	-	20	21	25
	200	94	0.01	3	-	-	-	-	-	-	-	-	-	-	-	20
7	700	330	0.03	7	-	-	23	26	29	31	22	-	21	26	30	35
	550	260	0.01	2	-	-	-	23	26	28	-	-	-	24	28	32
	400	189	0.01	2	-	-	-	23	23	24	-	-	-	20	23	26
	250	118	0.01	2	-	-	-	-	-	-	-	-	-	-	-	20
8	1100	519	0.02	4	-	20	25	28	33	36	-	20	25	29	31	35
	900	425	0.01	3	-	-	23	26	30	34	-	-	23	26	29	33
	700	330	0.01	2	-	-	23	25	30	33	-	-	21	24	26	31
	500	236	0.01	2	-	-	-	23	24	28	-	-	-	21	23	26
9	1400	661	0.01	2	-	21	25	28	33	36	20	20	23	28	34	38
	1150	543	0.01	2	-	-	20	26	29	31	-	-	21	25	31	35
	900	425	0.01	2	-	-	-	24	26	29	-	-	-	23	28	31
	650	307	0.01	2	-	-	-	23	23	25	-	-	-	20	23	26
10	1500	708	0.02	5	-	20	23	28	30	34	-	20	24	28	30	35
	1100	519	0.02	4	-	-	-	21	24	28	-	-	21	24	25	31
	700	330	0.01	2	-	-	-	-	-	21	-	-	-	21	23	28
	215	101	0.01	1	-	-	-	-	-	-	-	-	-	-	-	-
12	2500	1180	0.04	10	-	25	29	33	34	35	29	28	31	34	35	40
	2050	967	0.03	7	-	21	25	28	30	33	22	25	29	31	33	38
	1600	755	0.02	6	-	20	24	24	28	29	-	20	25	28	30	35
	1150	543	0.02	4	-	-	-	20	21	26	-	-	20	24	26	30
14	2650	1251	0.02	5	-	21	23	26	29	30	24	25	30	34	37	40
	2100	991	0.02	4	-	-	-	24	26	30	-	21	26	31	34	37
	1550	731	0.01	2	-	-	-	-	21	25	-	-	24	28	30	34
	1000	472	0.01	2	-	-	-	-	-	-	-	-	-	21	25	26
16	3725	1758	0.14	36	23	25	29	28	33	38	30	*	33	37	40	44
	2800	1321	0.12	30	-	-	-	24	24	28	23	24	29	34	36	40
	1800	849	0.05	12	-	-	-	-	-	21	-	-	24	29	31	35
	800	378	0.01	2	-	-	-	-	-	-	-	-	26	30	34	36
24 x 16	8330	3931	0.05	12	30	31	39	48	49	56	44	44	49	51	54	57
	7000	3303	0.04	10	27	29	36	43	46	49	43	43	48	50	53	56
	5350	2525	0.01	2	-	26	34	41	44	46	40	41	47	49	51	55
	3800	1793	0.01	2	-	-	24	28	29	32	32	38	44	46	48	51

Performance Notes:

1. NC Levels are calculated based on procedures as outlined on page A101.
2. Dash (-) in space indicates a NC less than 20.
3. Asterisk (*) in space indicates that the minimum inlet static pressure requirement is greater than 0.5" w.g. (125 Pa) at rated airflow.

A

SINGLE DUCT TERMINAL UNITS

Performance Data • Discharge Sound Power Levels

3000Q Series • Quiet • Dissipative Silencer

Fiberglass Acoustic Media (FAM)



A SINGLE DUCT TERMINAL UNITS

Inlet Size	Airflow		Min. inlet ΔPs		Sound Power Octave Bands @ Inlet Pressure (ΔPs) shown																																			
					Minimum ΔPs		0.5" w.g. (125Pa) ΔPs					1.0" w.g. (250Pa) ΔPs					1.5" w.g. (375Pa) ΔPs					2.0" w.g. (500Pa) ΔPs					3.0" w.g. (750Pa) ΔPs													
					"w.g.	Pa	2	3	4	5	6	7	2	3	4	5	6	7	2	3	4	5	6	7	2	3	4	5	6	7	2	3	4	5	6	7	2	3	4	5
4	200	94	0.38	94	58	47	35	25	24	30	60	55	41	29	26	31	62	55	42	29	28	35	65	58	44	32	31	38	64	58	46	33	32	40	65	60	49	37	36	44
	150	71	0.21	52	56	44	30	-	-	24	59	50	35	-	21	25	61	53	38	24	24	31	60	55	41	27	28	36	60	55	42	29	30	39	60	55	43	35	35	44
	100	47	0.11	28	51	39	-	-	-	-	54	44	29	-	-	21	54	46	35	-	22	30	55	47	37	27	27	35	56	47	38	30	30	38	56	47	38	31	35	43
	50	24	0.04	11	50	37	-	-	-	-	51	38	26	-	-	-	52	39	29	-	-	28	53	41	32	-	26	35	54	41	32	-	24	36	55	42	32	-	30	38
5	350	165	0.17	41	59	50	37	30	27	31	64	56	45	36	32	33	67	60	49	38	34	37	70	61	51	39	37	40	70	63	51	40	38	42	73	65	53	42	41	45
	250	118	0.10	25	56	45	30	-	-	22	61	55	39	29	23	27	66	58	41	32	27	32	68	60	44	34	31	37	68	61	46	35	32	39	69	62	49	37	35	42
	150	71	0.03	7	54	41	-	-	-	-	59	47	30	-	-	21	60	51	35	23	20	27	62	53	40	26	24	32	62	53	42	29	27	35	62	54	43	35	33	41
	100	47	0.02	5	53	41	-	-	-	-	56	44	30	-	-	-	57	46	34	23	24	28	59	48	37	25	25	34	59	48	37	26	28	36	59	49	39	31	33	40
6	500	236	0.05	13	53	44	32	35	28	27	59	53	40	41	37	36	63	56	43	41	38	39	68	62	46	42	39	42	68	62	48	44	41	44	72	64	52	45	43	47
	400	189	0.05	12	52	39	29	28	21	22	59	51	36	37	32	31	62	54	39	38	34	35	67	60	42	38	36	39	67	59	46	40	39	43	69	61	49	41	41	47
	300	142	0.03	6	54	37	21	-	-	-	60	46	33	31	27	30	62	49	36	33	30	33	65	54	39	34	33	39	65	54	42	37	37	42	66	56	45	38	40	45
	200	94	0.01	3	52	36	-	-	-	-	56	40	27	-	-	29	57	45	31	24	-	31	59	49	35	26	32	35	59	49	35	26	32	35	60	49	41	39	43	44
7	700	330	0.03	7	58	49	37	33	34	34	66	57	45	44	43	41	69	60	47	44	46	45	72	64	51	45	49	49	74	67	53	47	50	51	76	69	55	48	51	53
	550	260	0.04	10	56	46	32	28	26	26	62	54	40	38	38	37	66	57	43	39	42	42	69	62	46	40	45	45	72	64	49	43	46	48	73	66	51	44	48	51
	400	189	0.01	2	57	41	28	22	23	-	60	52	36	32	35	35	65	55	39	34	37	39	69	59	43	37	41	43	69	60	45	39	42	45	70	61	48	40	44	48
	250	118	0.01	2	54	32	-	-	-	-	54	43	25	-	24	26	56	45	29	22	26	30	60	49	32	25	31	35	59	49	34	31	33	39	60	48	36	31	35	43
8	1100	519	0.02	4	66	60	50	44	42	42	69	63	54	47	47	47	73	67	56	48	48	49	75	69	58	49	49	53	78	73	61	51	50	54	79	76	63	52	51	56
	900	425	0.01	3	63	56	44	38	34	35	68	60	49	43	42	42	71	65	52	45	44	46	74	67	55	46	45	49	76	71	58	48	46	51	78	74	60	49	48	53
	700	330	0.01	2	59	51	37	32	25	27	64	57	44	39	37	39	69	61	48	40	39	42	71	64	51	42	41	45	75	69	54	43	42	48	75	72	57	45	44	51
	500	236	0.01	2	57	45	29	22	-	-	61	54	40	32	29	32	64	59	43	33	33	37	69	64	47	36	35	41	69	65	51	38	37	44	70	68	54	41	39	48
9	1400	661	0.01	2	67	62	52	49	50	49	69	64	53	48	51	51	72	67	56	52	52	53	75	69	59	53	53	56	78	73	62	55	55	58	80	76	64	56	55	60
	1150	543	0.01	2	59	56	46	43	42	39	65	59	48	45	44	44	69	62	52	47	46	47	74	65	55	49	48	51	76	69	57	50	49	52	78	71	59	50	50	54
	900	425	0.01	2	55	52	41	39	34	30	64	56	45	43	41	41	68	60	48	44	43	44	72	64	51	45	44	48	74	67	53	46	46	50	75	70	56	47	48	53
	650	307	0.01	2	53	45	35	31	28	24	62	52	41	37	34	35	65	57	43	38	38	39	69	62	46	39	40	44	69	64	49	41	41	47	70	66	53	42	43	50
10	1500	708	0.02	5	67	55	45	45	45	43	69	62	52	47	51	51	71	65	54	48	52	54	75	68	56	50	53	57	77	71	59	51	54	58	80	74	60	52	55	60
	1100	519	0.02	4	63	49	37	36	30	26	61	56	45	42	42	40	66	59	47	43	44	45	70	62	50	45	46	50	72	65	53	45	47	51	74	69	55	47	49	53
	700	330	0.01	2	56	40	28	22	-	-	56	49	37	34	31	31	60	54	41	35	35	38	65	58	44	36	39	43	66	61	47	38	41	46	66	63	50	39	44	49
	215	101	0.01	1	42	-	-	-	-	-	38	29	-	-	-	-	46	37	22	-	-	-	49	45	26	-	-	21	49	45	30	-	22	27	48	47	34	20	26	32
12	2500	1180	0.04	10	64	55	49	49	53	50	73	65	57	54	59	59	76	68	59	55	59	61	79	70	62	56	60	64	80	72	63	58	62	65	81	74	65	60	63	67
	2050	967	0.03	7	63	51	44	45	48	43	70	61	52	50	55	53	73	65	55	52	57	57	75	67	58	53	58	59	77	69	59	54	59	61	79	72	62	57	61	63
	1600	755	0.02	6	61	48	39	42	40	35	69	58	49	47	52	49	72	62	50	48	53	51	72	64	54	49	55	54	75	67	55	50	55	55	75	70	58	52	57	58
	1150	543	0.02	4	54	44	34	35	29	25	60	54	43	43	45	40	65	58	46	44	47	44	69	62	49	46	50	49	70	64	51	47	52	52	73	68	55	49	54	55
14	2650	1251	0.02	5	62	52	47	50	51	48	68	60	53	53	57	57	71	62	57	55	58	59	74	65	59	57	60	62	76	67	62	60	62	63	77	69	65	62	64	66
	2100	991	0.02	4	59	47	42	45	44	40	62	56	50	50	53	51	66	58	53	52	55	54	72	62	56	54	57	57	74	65	60	57	59	60	77	67	63	60	61	62
	1550	731	0.01	2	58	42	36	37	32	28	58	51	45	45	46	43	64	54	49	48	49	47	68	59	53	51	53	52	70	61	56	53	55	54	73	64	59	55	57	57
	1000	472	0.01	2	52	38	27	22	-	-	56	45	40	39	37	35	60	49	44	42	42	40	64	53	48	46	47	46	66	56	52	49	50	50	67	58	55	51	53	53
16	3725	1758	0.14	36	62	52	52	58	63	59	70	63	59	62	63	61	76	67	64	57	62	61	75	69	62	59	63	63	79	72	66	60	65	63	83	73	67	61	65	66
	2800	1321	0.12	30	53	48	44	47	47	43	62	57	51	50	52	50	68	60	55	52	54	53	72	63	58	54	56	57	72	66	60	55	57	59	75	68	62	57	60	61
	1800	849	0.05	12	49	40	35	36	31	27	58	51	45	43	43	40	62	55	48	46	47	46	66	58	51	48	50	50	68											

Performance Data • Radiated Sound Power Levels

3000Q Series • Quiet • Dissipative Silencer
Fiberglass Acoustic Media (FAM)



Inlet Size	Airflow		Min. inlet ΔPs		Sound Power Octave Bands @ Inlet Pressure (ΔPs) shown																																									
					Minimum ΔPs							0.5" w.g. (125Pa) ΔPs							1.0" w.g. (250Pa) ΔPs							1.5" w.g. (375Pa) ΔPs							2.0" w.g. (500Pa) ΔPs							3.0" w.g. (750Pa) ΔPs						
					"w.g.	Pa	2	3	4	5	6	7	2	3	4	5	6	7	2	3	4	5	6	7	2	3	4	5	6	7	2	3	4	5	6	7	2	3	4	5	6	7				
4	200	94	0.38	94	-	36	33	32	-	-	-	39	37	38	29	29	49	46	43	37	30	29	53	52	47	40	32	31	53	53	50	42	33	33	54	55	53	47	37	37						
	150	71	0.23	57	-	35	29	31	-	-	-	40	36	30	25	23	47	46	40	34	28	26	49	50	47	39	31	30	47	48	48	43	34	32	48	48	48	50	40	37						
	100	47	0.11	28	-	-	-	-	-	-	-	37	32	27	-	-	-	43	42	34	27	23	-	44	45	41	32	29	-	43	46	46	36	32	-	42	44	51	43	38						
	50	24	0.04	11	-	-	-	-	-	-	-	37	38	30	-	-	-	36	41	40	32	27	-	35	40	43	38	31	-	35	40	43	38	31	-	32	36	37	35	37						
5	350	165	0.17	41	48	39	33	32	30	27	52	45	39	38	37	32	55	48	45	38	36	32	59	51	49	40	39	34	61	54	51	42	40	36	61	57	55	45	44	40						
	250	118	0.08	20	-	35	31	25	23	-	50	40	36	32	30	25	54	45	42	33	32	28	55	48	45	35	35	30	56	51	48	37	32	57	53	51	42	41	35							
	150	71	0.03	7	-	-	-	-	-	-	49	35	31	23	20	20	50	41	39	30	29	21	50	43	43	34	33	27	48	45	45	40	39	31	51	45	46	46	44	37						
	100	47	0.02	5	-	-	-	-	-	-	33	29	-	-	-	-	39	38	28	26	-	-	40	42	36	34	26	46	40	43	43	41	31	47	41	43	47	46	37							
6	500	236	0.05	13	48	44	38	36	30	28	49	48	42	40	33	30	57	52	46	41	35	32	60	54	49	45	36	34	62	57	51	45	40	38	65	59	55	47	43	42						
	400	189	0.04	10	-	42	33	33	28	26	49	46	39	35	30	28	56	49	44	38	32	29	59	52	47	40	36	33	62	54	49	42	39	36	64	58	54	45	42	41						
	300	142	0.03	6	-	34	27	26	-	-	47	42	35	29	25	-	55	46	40	33	30	28	58	49	44	36	33	32	59	51	47	38	36	34	60	55	51	43	39	39						
	200	94	0.01	3	-	-	-	-	-	-	47	36	30	24	-	-	53	43	38	30	29	28	53	45	43	32	31	30	53	47	44	36	32	32	55	49	46	43	37	37						
7	700	330	0.03	7	49	46	48	37	33	32	49	48	45	37	31	30	56	51	47	40	34	31	62	57	52	45	37	34	66	60	55	48	40	37	68	64	60	52	44	42						
	550	260	0.01	2	48	43	41	33	27	25	48	44	40	32	28	26	55	49	45	38	32	30	61	54	49	43	36	33	64	58	52	45	38	36	65	61	57	50	42	40						
	400	189	0.01	2	46	39	33	33	-	-	46	43	38	30	26	20	53	48	43	37	31	29	57	51	46	41	34	32	59	53	49	44	36	34	60	56	52	47	40	40						
	250	118	0.01	2	-	-	20	31	-	-	-	39	34	28	21	-	51	46	41	35	29	27	54	47	43	38	31	30	53	48	44	40	33	32	53	49	46	43	37	38						
8	1100	519	0.02	4	52	50	45	37	34	33	57	51	46	37	35	32	60	54	51	40	38	33	65	57	53	43	42	36	67	60	56	45	44	39	70	63	60	49	48	42						
	900	425	0.01	3	51	47	40	34	31	29	56	50	45	37	34	31	58	53	49	39	37	33	63	56	51	42	42	36	65	58	54	44	44	39	68	60	56	47	48	42						
	700	330	0.01	2	50	43	37	31	29	25	51	47	42	33	31	28	57	51	47	37	36	32	61	53	50	40	39	35	63	55	51	42	41	37	64	59	56	45	44	40						
	500	236	0.01	2	-	38	30	27	24	-	50	44	39	31	29	25	55	48	44	35	34	31	58	51	47	37	37	33	59	53	49	39	39	36	61	55	52	43	43	40						
9	1400	661	0.01	2	51	46	46	44	37	35	52	47	46	41	38	35	57	53	49	42	37	35	64	58	53	47	41	37	66	63	57	50	43	40	69	67	61	54	47	44						
	1150	543	0.01	2	50	45	44	41	34	34	51	46	45	40	36	33	56	52	47	41	36	34	62	56	51	45	39	37	64	61	55	49	42	39	67	64	59	52	46	43						
	900	425	0.01	2	48	40	39	36	30	29	50	45	42	37	32	30	56	50	45	40	35	33	60	54	49	44	39	36	63	58	52	47	41	38	64	61	56	50	44	42						
	650	307	0.01	2	47	36	31	28	21	-	49	41	36	31	28	25	54	48	42	37	32	30	57	51	46	41	35	33	59	54	49	44	38	36	60	57	52	47	41	39						
10	1500	708	0.02	5	54	43	43	38	34	26	56	48	46	39	35	30	58	53	50	44	38	34	62	57	53	48	42	38	64	59	55	50	45	41	66	64	59	54	48	45						
	1100	519	0.02	4	51	37	35	30	25	-	53	46	42	35	31	27	55	50	47	41	35	31	60	54	50	45	39	36	61	56	51	47	42	39	64	61	55	51	45	43						
	700	330	0.01	2	-	33	29	25	-	-	50	43	38	32	29	25	55	48	43	38	33	30	58	52	47	42	37	34	59	54	49	44	39	37	61	57	53	49	43	41						
	215	101	0.01	1	-	-	-	-	-	-	41	36	30	27	25	-	51	41	35	32	29	28	53	43	39	36	32	30	56	45	40	38	34	33	57	47	44	42	38	37						
12	2500	1180	0.04	10	57	55	54	50	42	36	60	57	53	46	41	38	63	61	54	50	42	39	66	63	57	53	45	41	67	64	59	55	48	44	70	69	63	59	52	50						
	2050	967	0.03	7	55	50	48	44	37	33	58	55	51	46	39	35	61	59	53	49	42	37	64	61	56	52	45	41	65	62	58	55	48	44	68	67	61	58	51	49						
	1600	755	0.02	6	52	45	41	36	30	27	56	52	45	40	34	30	59	56	49	46	38	35	61	58	53	49	42	39	62	60	55	51	44	42	65	64	58	55	48	46						
	1150	543	0.02	4	47	38	31	27	23	-	52	48	40	36	30	26	55	52	45	41	34	32	58	55	49	45	38	36	59	57	51	48	41	39	61	60	55	52	45	44						
14	2650	1251	0.02	5	57	53	50	46	42	35	58	56	49	44	40	35	62	60	53	48	45	39	64	63	56	50	47	44	65	66	59	52	49	47	69	69	63	57	52	50						
	2100	991	0.02	4	54	48	44	39	35	30	56	53	46	41	37	31	60	57	50	44	41	38	63	61	55	48	44	43	64	63	57	50	46	45	66	66	60	55	50	48						
	1550	731	0.01	2	46	40	35	30	26	-	51	48	42	35	31	27	57	55	48	40	36	35	60	58	52	45	40	39	60	60	53	47	43	41	62	63	57	52	47	45						
	1000	472	0.01	2	-	-	-	-	-	-	48	45	37	31	28	24	52	51	43	37	33	31	54	53	46	41	37	35	55	56	49	44	40	38	56	57	52	48	43	42						
16	3725	1758	0.14	36	58	58	55	51	45	38	* * * * *	64	62	57	53	48	39	67	66	60	56	50	45	69	69	62	57	51	49	71	72	65	59	53	49	71	72	65	59	53	49					
	2800	1321	0.12	30	54	51	49	43	37	32	59	55	50	44	38	32	62	59	53	47	41	35	65	63	57	50	44	39	66	65	59	52	46	41	68	69	62	56	50	46						
	1800	849	0.05	12	47	40	37	30	24	-	52	49	42	36	32	27	57	55	49	41	36	32	59	59	52	44	39	35	61	61	54	48	42	38	62	64	57	52	46	43						
	800	991	0.01	2	49	44	41	34	28	-	54	50	44	37	34	28	59	57	50	42	37	32	61	60	53	45	40	36	63	63	56	49	43	39	64	65	58	53	47	44						
24 x 16	8330	3931	0.05	12	70	67</																																								

Performance Data • AHRI Certification and Performance Notes

3000Q Series • Quiet • Dissipative Silencer • AHRI Certification Rating Points

Fiberglass Acoustic Media (FAM)

Inlet Size	Airflow		Min. Inlet ΔPs		Discharge Sound Power Levels @ 1.5" w.g. (375 Pa) ΔPs							Radiated Sound Power Levels @ 1.5" w.g. (375 Pa) ΔPs						
					Octave Band							Octave Band						
	cfm	l/s	"w.g.	Pa	2	3	4	5	6	7	2	3	4	5	6	7		
4	150	71	0.21	52	60	55	41	27	28	36	49	50	47	39	31	30		
5	250	118	0.10	25	68	60	44	34	31	37	55	48	45	35	35	30		
6	400	189	0.05	12	67	60	42	38	36	39	59	52	47	40	36	33		
7	550	260	0.04	10	69	62	46	40	45	45	61	54	49	43	36	33		
8	700	330	0.01	2	71	64	51	42	41	45	61	53	50	40	39	35		
9	900	425	0.01	2	72	64	51	45	44	48	60	54	49	44	39	36		
10	1100	519	0.02	5	70	62	50	45	46	50	60	54	50	45	39	36		
12	1600	755	0.02	5	72	64	54	49	55	54	61	58	53	49	42	39		
14	2100	991	0.02	5	72	62	56	54	57	57	63	61	55	48	44	43		
16	2800	1321	0.12	30	72	63	58	54	56	57	65	63	57	50	44	39		
24 x 16	5350	2525	0.01	2	86	78	76	72	73	73	72	70	70	65	60	55		



Ratings are certified in accordance with AHRI Standards.

Performance Notes for Sound Power Levels:

- Discharge sound power is the noise emitted from the unit discharge into the downstream duct. Discharge Sound Power Levels (SWL) now include duct end reflection energy as part of the standard rating. Including the duct end correction provides sound power levels that would normally be transmitted into an acoustically, non-reflective duct. The effect of including the energy correction to the discharge SWL, is higher sound power levels when compared to previous AHRI certified data. For more information on duct end reflection calculations see AHRI Standard 880.
- Radiated sound power is the breakout noise transmitted through the unit casing walls.
- Sound power levels are in decibels, dB re 10⁻¹² watts.
- All sound data listed by octave bands is raw data without any corrections for room absorption or duct attenuation. Dash (-) in space indicates sound power level is less than 20 dB or equal to background.
- Minimum inlet ΔPs is the minimum operating pressure requirement of the unit (damper full open) and the difference in static pressure from inlet to discharge of the unit.
- Asterisk (*) in space indicates that the minimum inlet static pressure requirement is greater than 0.5" w.g. (125 Pa) at rated airflow.
- Data derived from independent tests conducted in accordance with ANSI/ASHRAE Standard 130 and AHRI Standard 880.

A SINGLE DUCT TERMINAL UNITS

30HQ SERIES • HOSPITAL GRADE • QUIET TYPE WITH DISSIPATIVE SILENCER

PRODUCT OVERVIEW

Nailor 30HQ Series Single Duct Hospital Grade Terminal units control the flow of conditioned primary air in a constant or variable air volume (VAV) HVAC system. Each unit is comprised of a VAV terminal section coupled with a factory installed dissipative silencer and unique design features specifically tailored for IAQ (Indoor Air Quality) sensitive hospital applications. Integral electric or hot water coil sections are also available for re-heat applications.

Hospital projects frequently size VAV terminals more aggressively than general office buildings due to increased space restrictions. The 30HQ Series design and construction addresses hospital environments that require both low sound operating levels and high IAQ adherence. Many of the 30HQ Series standard features such as the inclined opposed damper and Diamond Flow Sensor are borrowed from the robust 3000 Series of terminal units. Other features, like the silencer and liners options, are specifically chosen to address hospital maintenance and sanitation practices. The factory installed dissipative silencer provides minimal impact on system pressure drop while simultaneously delivering superior sound attenuation. By combining optimized side baffle geometry with mylar encapsulated fiberglass acoustic media, the silencer provides excellent attenuation.

While quiet operation is paramount, maintenance and sanitation requirements cannot be overlooked. The mylar barrier, encased within the silencer side baffles, prevents entrainment of fiberglass fibers into the airstream and acts a vapor barrier to the acoustics media, preventing mold and fungi growth. All 30HQ Series VAV sections include Steri-Liner, a rigid fiberglass board with a reinforced non-porous aluminum FSK (Foil-scrim-Kraft). This insulation is also found in the silencer sections not covered by the sound attenuating side baffles. Steri-Liner provides a durable, cleanable surface while offering excellent insulating and sound absorbing characteristics. Another benefit to using Steri-Liner in the factory installed silencer is that the internal insulation eliminates the need for field applying thermal duct wrap, thus saving on additional labor and costs.

In the past, selecting a silencer to mate with a VAV terminal involved multiple calculations, guesswork and an intimate knowledge of silencer performance. The engineer or contractor had to contend with pressure classes, sizes and free area to balance the associated pressure drop, attenuation and self generated noise against the VAV terminal performance. Even after careful selection, the result was still a guess due to the unknown system effect created by the close coupled terminal/silencer assembly. Since each 30HQ Series unit is designed, manufactured and tested as a complete assembly, the guesswork is eliminated.

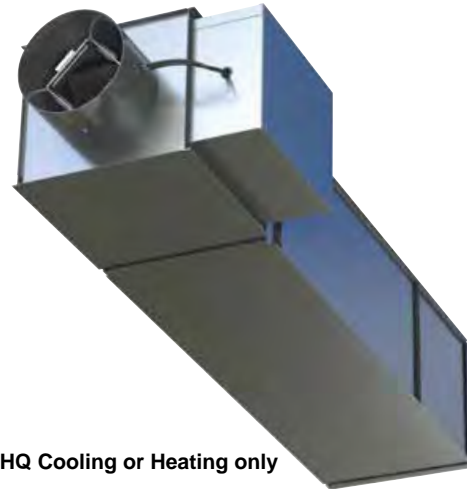

30HQ Cooling or Heating only



30HQW Cooling with Hot Water Reheat



30HQE Cooling with Electric Reheat

SINGLE DUCT VARIABLE OR CONSTANT AIR VOLUME

30HQ SERIES

- HOSPITAL GRADE
- DISSIPATIVE SILENCER
- SUPER QUIET

Models:

- 30HQ** Cooling or Heating only
- 30HQW** Cooling with Hot Water Reheat
- 30HQE** Cooling with Electric Reheat

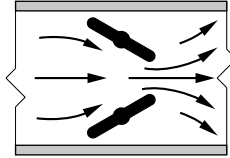

Inclined opposed blade damper configuration minimizes noisy turbulence and provides smooth, accurate, near linear flow control.

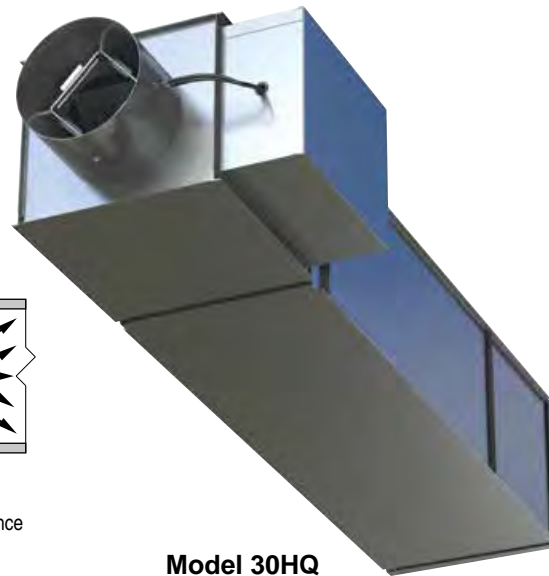

Model 30HQ

Hospital system designs have to contend with the presence of infectious diseases, chemical hazards, biological contaminants and low sound level requirements. The 30HQ hospital grade terminal unit has been purposely designed to address these parameters by using innovative options and construction methods, resulting in simplified maintenance and improved sound performance.

Each unit includes a factory mounted dissipative silencer that maximizes acoustical attenuation, minimizes pressure loss and reduces self-generated sound. Steri-liner insulation offers a durable, cleanable surface throughout the VAV section and the exposed silencer portions. By fully lining the silencer, there is no need to field apply external thermal duct wrap. Optional components such as access doors and removable flow sensors enhance the functionality of the 30HQ Series units to provide optimum performance and flexibility in hospital environments.

STANDARD FEATURES:

- Designed for hospital and other critical environment applications where IAQ (Indoor Air Quality) is a concern.
- 22 ga. (0.86) galvanized steel casing, mechanically sealed, low leakage construction.
- 16 ga. (1.63) corrosion-resistant steel inclined opposed blade damper with extruded PVC seals (single blade on size 4, 5, 6). 45° rotation, CW to close. Tight shut-off. Damper leakage is less than 2% of the terminal rated airflow at 3" w.g. (746 Pa)
- 1/2" (13) dia. plated steel drive shaft. An indicator mark on the end of the shaft shows damper position.
- Multi-point averaging Diamond Flow Sensor. Aluminum construction. Supplied with balancing tees.
- Rectangular discharge with slip and drive cleat duct connection.
- Full NEMA 1 type controls enclosure for factory mounted controls.
- VAV section is lined with 13/16" (21) thick, 4 lb. density Steri-Liner insulation. Fiberglass with a reinforced aluminum

FSK facing. Meets the requirements of NFPA 90A, UL 181 and ASTM C655.

- Right-hand controls location is standard and is determined looking into direction of airflow. Optional left hand controls mounting is available. Unit is flippable. Caution: If unit has access door.
- Available in 11 sizes ranging from 0 to 8330 cfm (0-3931 l/s) for 30HQ and 30HQW units. 25-8330 cfm (12-3931 l/s) on 30HQE.

Silencer Section:

- Designed to mate with VAV section for optimum performance and quiet operation.
- Optimized internal baffle geometry reduces self-generated noise, maximizes acoustic attenuation.
- 22 ga. (0.86) coated steel perforated baffles with 13% free area encapsulate fiberglass acoustic media. Mylar lining with acoustical spacer isolates material from airstream.
- Internal Steri-Liner insulation on top and bottom optimizes sound reduction

and eliminates need for external field applied thermal duct wrap.

Options and Accessories:

- Bottom access door.
- FMI Removable insert type Diamond Flow Sensor.
- 24 VAC control transformer.
- Toggle disconnect switch.
- Hanger brackets.
- Controls enclosure for field or factory mounted controls.
- Dust tight enclosure seal.
- 20 ga. (1.00) construction.
- Seismic certification.
- Oversized casing.



Intertek

Dimensions

Model 30HQ • Hospital Grade • Dissipative Silencer

Digital and Analog Electronic Controls

- A full NEMA 1 controls enclosure is provided for factory mounted controls. Optional for field mounted controls.

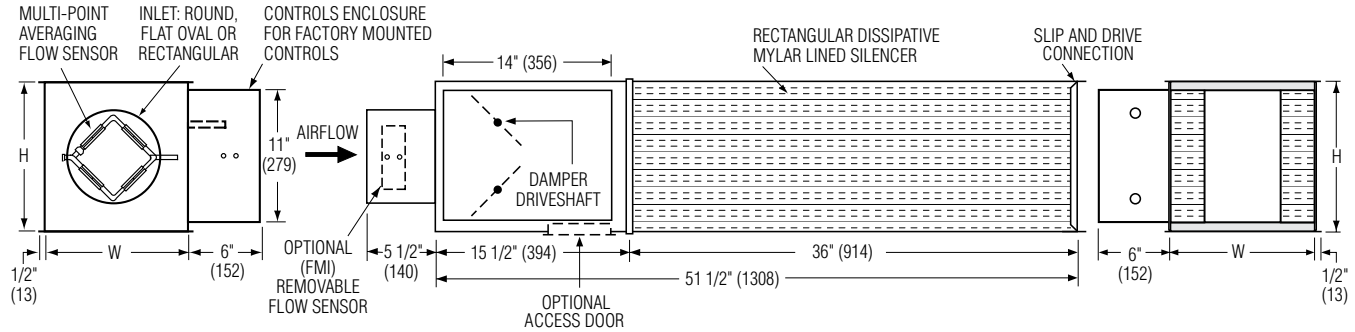

Pneumatic Controls

- Universal pneumatic control mounting panel features double wall stand-off construction for strength and rigidity. Controls mounting screws do not penetrate terminal casing.

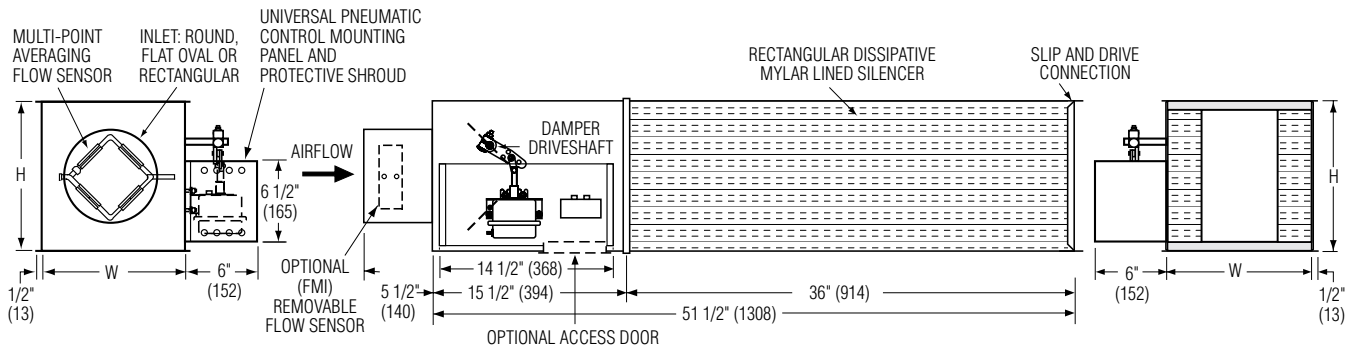

Dimensional Data

Unit Size	W	H	Inlet Size
4	10 (254)	10 (254)	3 7/8 (98) Round
5	10 (254)	10 (254)	4 7/8 (124) Round
6	10 (254)	10 (254)	5 7/8 (149) Round
7	12 (305)	12 1/2 (318)	6 7/8 (175) Round
8	12 (305)	12 1/2 (318)	7 7/8 (200) Round
9	14 (356)	12 1/2 (318)	8 7/8 (225) Round
10	14 (356)	12 1/2 (318)	9 7/8 (251) Round
12	18 (457)	12 1/2 (318)	12 15/16 x 9 13/16 (329 x 249) Oval
14	24 (610)	12 1/2 (318)	16 1/16 x 9 13/16 (408 x 249) Oval
16	28 (711)	12 1/2 (318)	19 3/16 x 9 13/16 (487 x 249) Oval
24 x 16	38 (965)	18 (457)	23 7/8 x 15 7/8 (606 x 403) Rect.

Dimensions

Model 30HQW • Hospital Grade • Dissipative Silencer • Hot Water Reheat Coil

- One, two, three and four row available.
- Hot water coils have copper tubes and aluminum ripple fins.
- Coils have 1/2" (13), 7/8" (22) or 1 3/8" (35) O.D. sweat connections.
- Right or left hand coil connection is determined by looking through the terminal inlet in the direction of airflow.
- Galvanized steel casing with slip and drive discharge duct connection.
- Optional low leakage gasketed access door is recommended for coil access and cleaning.
- AHRI Certified coils.
- Coil Performance data on pages A43-A51.
- Oversized casing option on pages A40-A42.

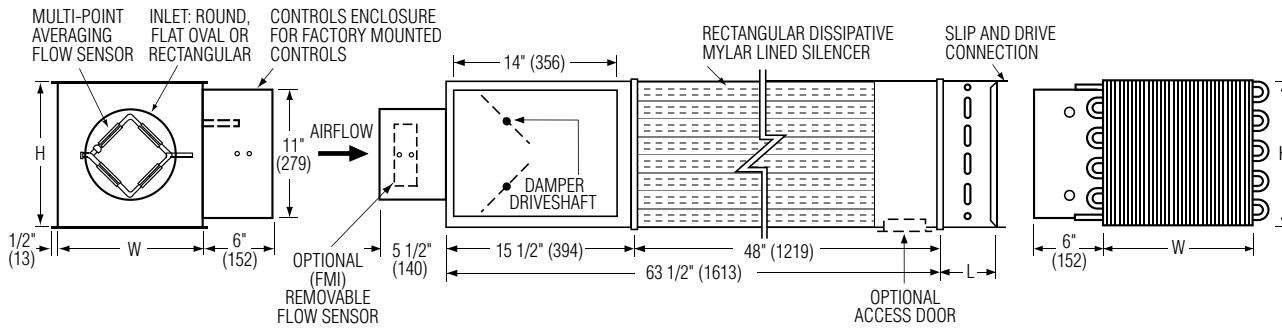

30HQE • Hospital Grade • Dissipative Silencer • Integral Electric Reheat

- Electric coil is factory mounted in an integral extended plenum section.
- Full details and selection guide on page A52.

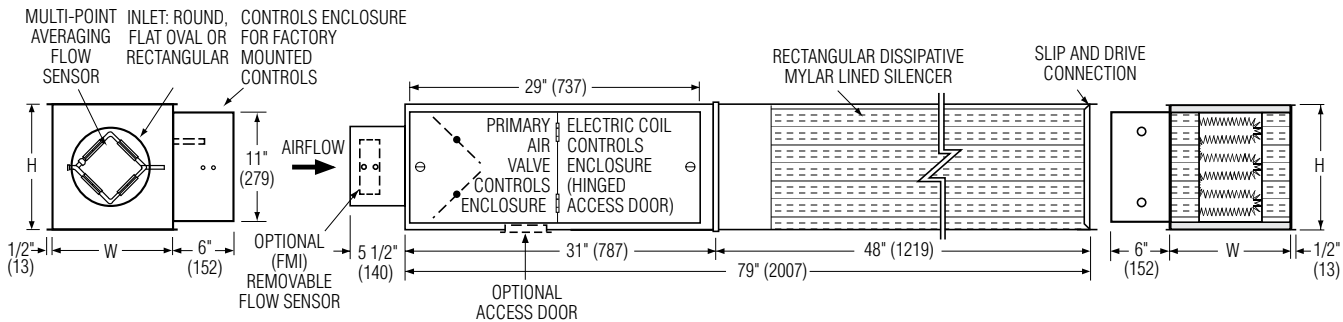

Dimensional Data

Unit Size	W	H	Inlet Size	Coil Connections				Hot Water Coil	
				1 Row	2 Row	3 Row	4 Row	L (1 & 2 Row)	L (3 & 4 Row)
4	10 (254)	10 (254)	3 7/8 (98) Round	1/2 (13)	7/8 (22)	7/8 (22)	7/8 (22)	5 (127)	7 1/2 (191)
5	10 (254)	10 (254)	4 7/8 (124) Round	1/2 (13)	7/8 (22)	7/8 (22)	7/8 (22)	5 (127)	7 1/2 (191)
6	10 (254)	10 (254)	5 7/8 (149) Round	1/2 (13)	7/8 (22)	7/8 (22)	7/8 (22)	5 (127)	7 1/2 (191)
7	12 (305)	12 1/2 (318)	6 7/8 (175) Round	1/2 (13)	7/8 (22)	7/8 (22)	7/8 (22)	5 (127)	7 1/2 (191)
8	12 (305)	12 1/2 (318)	7 7/8 (200) Round	1/2 (13)	7/8 (22)	7/8 (22)	7/8 (22)	5 (127)	7 1/2 (191)
9	14 (356)	12 1/2 (318)	8 7/8 (225) Round	1/2 (13)	7/8 (22)	7/8 (22)	7/8 (22)	5 (127)	7 1/2 (191)
10	14 (356)	12 1/2 (318)	9 7/8 (251) Round	1/2 (13)	7/8 (22)	7/8 (22)	7/8 (22)	5 (127)	7 1/2 (191)
12	18 (457)	12 1/2 (318)	12 15/16 x 9 13/16 (329 x 249) Oval	1/2 (13)	7/8 (22)	7/8 (22)	7/8 (22)	5 (127)	7 1/2 (191)
14	24 (610)	12 1/2 (318)	16 1/16 x 9 13/16 (408x 249) Oval	1/2 (13)	7/8 (22)	7/8 (22)	7/8 (22)	5 (127)	7 1/2 (191)
16	28 (711)	12 1/2 (318)	19 3/16 x 9 13/16 (487 x 249) Oval	7/8 (22)	7/8 (22)	7/8 (22)	7/8 (22)	5 (127)	7 1/2 (191)
24 x 16	38 (965)	18 (457)	23 7/8 x 15 7/8 (606 x 403) Rect.	7/8 (22)	7/8 (22)	1 3/8 (35)	1 3/8 (35)	5 (127)	7 1/2 (191)

SINGLE DUCT TERMINAL UNITS

A

Recommended Airflow Ranges For Single Duct Terminal Units

The recommended airflow ranges below are for 30HQ Series single duct terminal units with pressure independent controls and are presented as ranges for total and controller specific minimum and maximum airflow. Airflow ranges are based upon maintaining reasonable sound levels and controller limits using Nailor's Diamond Flow Sensor as the airflow measuring device. For a given unit size, the minimum, auxiliary minimum (where applicable) and the maximum flow setting must be within the range limits to ensure pressure independent operation, accuracy and repeatability.

Minimum airflow limits are based upon .02" w.g. (5 Pa) differential pressure signal from Diamond Flow Sensor on analog/digital controls and .03" (7.5) for pneumatic controllers. This is a realistic low limit for many transducers used in the digital controls industry. Check your controls supplier for minimum limits. Setting airflow minimums lower, may cause damper hunting and result in a failure to meet minimum ventilation requirements. Factory settings will therefore not be made outside these ranges; however, a minimum setting of zero (shut-off) is an available option on pneumatic units. Where an auxiliary setting is specified, the value must be greater than the minimum setting.

The high end of the tabulated Total Airflow Range on pneumatic and analog electronic controls represents the Diamond Flow Sensor's differential pressure reading at 1" w.g. (250 Pa). The high end airflow range for digital controls is represented by the indicated transducer differential pressure.

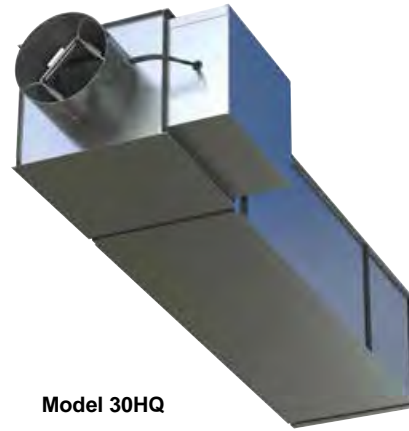

Model 30HQ

ASHRAE 130 "Performance Rating of Air Terminals" is the method of test for the certification program. The "standard rating condition" (certification rating point) airflow volumes for each terminal unit size are tabulated below per AHRI Standard 880. These air volumes equate to an approximate inlet velocity of 2000 fpm (10.2 m/s).

When digital or other controls are mounted by Nailor, but supplied by others, these values are guidelines only, based upon experience with the majority of controls currently available. Controls supplied by others for factory mounting are configured and calibrated in the field. Airflow settings on pneumatic and analog controls supplied by Nailor are factory preset when provided.

Imperial Units, Cubic Feet per Minute

Unit Size	Inlet Type	Total Airflow Range, cfm	Airflow at 2000 fpm Inlet Velocity (nom.), cfm	Range of Minimum and Maximum Settings, cfm							
				Pneumatic 3000 Controller		Analog Electronic Controls		Digital Controls			
				Transducer Differential Pressure ("w.g.)							
				Min.	Max.	Min.	Max.	Min.	Max.	Min.	Max.
				.03	1.0	.02	1.0	.02	1.0	1.25	1.5
4	Round	0 – 225	150	30	180	25	180	25	180	200	225
5		0 – 400	250	55	325	45	325	45	325	360	400
6		0 – 550	400	80	450	65	450	65	450	500	550
7	Round	0 – 800	550	115	650	95	650	95	650	725	800
8		0 – 1100	700	155	900	125	900	125	900	1000	1100
9		0 – 1400	900	200	1150	165	1150	165	1150	1285	1400
10		0 – 1840	1100	260	1500	215	1500	215	1500	1675	1840
12	Flat Oval	0 – 2500	1600	355	2050	290	2050	290	2050	2300	2500
14		0 – 3125	2100	440	2550	360	2550	360	2550	2850	3125
16		0 – 3725	2800	525	3040	430	3040	430	3040	3400	3725
24 x 16	Rect.	0 – 8330	5350	1180	6800	960	6800	960	6800	7600	8330

Metric Units, Liters per Second

Unit Size	Inlet Type	Total Airflow Range, l/s	Airflow at 10.2 m/s Inlet Velocity (nom.), l/s	Range of Minimum and Maximum Settings, l/s							
				Pneumatic 3000 Controller		Analog Electronic Controls		Digital Controls			
				Transducer Differential Pressure (Pa)							
				Min.	Max.	Min.	Max.	Min.	Max.	Min.	Max.
				7.5	249	5	249	5	249	311	374
4	Round	0 – 106	71	14	85	12	85	12	85	94	106
5		0 – 189	118	26	153	21	153	21	153	170	189
6		0 – 260	189	38	212	31	212	31	212	236	260
7	Round	0 – 378	260	54	307	45	307	45	307	342	378
8		0 – 519	330	73	425	59	425	59	425	472	519
9		0 – 661	425	94	543	78	543	78	543	606	661
10		0 – 868	519	123	708	101	708	101	708	790	868
12	Flat Oval	0 – 1180	755	168	967	137	967	137	967	1085	1180
14		0 – 1475	991	208	1203	170	1203	170	1203	1345	1475
16		0 – 1758	1321	248	1435	203	1435	203	1435	1604	1758
24 x 16	Rect.	0 – 3931	2525	557	3209	453	3209	453	3209	3586	3931

Performance Data • NC Level Application Guide

Model 30HQ • Hospital Grade • Dissipative Silencer

Terminal: Steri-Liner • Silencer: Mylar, Spacer, Steri-Liner (MSSL) Media

Inlet Size	Airflow cfm / s		Min. inlet ΔPs "w.g. Pa		NC Levels @ Inlet Pressure (ΔPs) shown											
					DISCHARGE					RADIATED						
					Min. ΔPs	0.5" w.g. (125 Pa)	1.0" w.g. (250 Pa)	1.5" w.g. (375 Pa)	2.0" w.g. (500 Pa)	3.0" w.g. (750 Pa)	Min. ΔPs	0.5" w.g. (125 Pa)	1.0" w.g. (250 Pa)	1.5" w.g. (375 Pa)	2.0" w.g. (500 Pa)	3.0" w.g. (750 Pa)
4	200	94	0.38	94	-	-	-	21	21	24	-	-	-	21	24	28
	150	71	0.21	52	-	-	-	-	-	-	-	-	-	21	22	22
	100	47	0.11	28	-	-	-	-	-	-	-	-	-	-	20	23
	50	24	0.05	12	-	-	-	-	-	-	-	-	-	-	-	-
5	350	165	0.17	41	-	-	20	23	24	26	-	-	-	23	25	30
	250	118	0.10	25	-	-	20	23	23	25	-	-	-	-	22	25
	150	71	0.03	7	-	-	-	-	-	-	-	-	-	-	-	20
	100	47	0.02	5	-	-	-	-	-	-	-	-	-	-	-	-
6	500	236	0.05	13	-	-	-	23	25	28	-	-	20	23	26	30
	400	189	0.05	12	-	-	-	-	21	24	-	-	-	21	25	29
	300	142	0.03	6	-	-	-	-	-	-	-	-	-	20	21	25
	200	94	0.01	3	-	-	-	-	-	-	-	-	-	-	-	20
7	700	330	0.03	7	-	-	20	25	28	31	22	-	21	26	30	35
	550	260	0.04	10	-	-	-	21	25	28	-	-	-	24	28	32
	400	189	0.01	2	-	-	-	20	21	23	-	-	-	20	23	26
	250	118	0.01	2	-	-	-	-	-	-	-	-	-	-	-	20
8	1100	519	0.02	4	21	24	28	30	34	37	-	20	25	29	31	35
	900	425	0.01	3	-	20	24	28	31	35	-	-	23	26	29	33
	700	330	0.01	2	-	-	21	26	30	34	-	-	21	24	26	31
	500	236	0.01	2	-	-	-	23	25	28	-	-	-	21	23	26
9	1400	661	0.01	2	-	24	28	30	34	37	20	20	23	28	34	38
	1150	543	0.01	2	-	-	21	25	29	33	-	-	21	25	31	35
	900	425	0.01	2	-	-	-	23	26	30	-	-	-	23	28	31
	650	307	0.01	2	-	-	-	21	24	26	-	-	-	20	23	26
10	1500	708	0.02	5	-	21	25	29	33	35	-	20	24	28	30	35
	1100	519	0.02	4	-	-	-	23	26	30	-	-	21	24	25	31
	700	330	0.01	2	-	-	-	-	23	25	-	-	-	-	21	24
	215	101	0.01	1	-	-	-	-	-	-	-	-	-	-	-	-
12	2500	1180	0.04	10	-	26	30	33	35	36	29	28	31	34	35	40
	2050	967	0.03	7	-	23	25	28	30	33	22	25	29	31	33	38
	1600	755	0.02	6	-	-	23	25	28	29	-	20	25	28	30	35
	1150	543	0.02	4	-	-	-	-	21	24	-	-	20	24	26	30
14	2650	1251	0.02	5	-	21	25	28	30	33	24	25	30	34	37	40
	2100	991	0.02	4	-	-	20	24	28	30	-	21	26	31	34	37
	1550	731	0.01	2	-	-	21	26	30	33	-	-	24	28	30	34
	1000	472	0.01	2	-	-	-	-	-	-	-	-	-	21	25	26
16	3725	1758	0.14	36	-	23	26	30	33	35	30	*	33	37	40	44
	2800	1321	0.12	30	-	-	21	25	29	31	23	24	29	34	36	40
	1800	849	0.05	12	-	-	-	-	21	24	-	-	24	29	31	35
	700	330	0.01	2	-	-	-	-	-	-	-	-	-	-	-	21
24 x 16	8330	3931	0.05	12	34	44	40	46	50	53	44	44	49	51	54	57
	7000	3303	0.03	7	25	36	38	44	48	49	40	41	47	49	51	55
	5350	2525	0.01	3	21	33	36	43	45	46	32	38	44	46	48	51
	3800	1793	0.01	2	-	20	25	29	30	33	24	35	39	43	45	47

Performance Notes:

1. NC Levels are calculated based on procedures as outlined on page A101.
2. Dash (-) in space indicates a NC less than 20.
3. Asterisk (*) in space indicates that the minimum inlet static pressure requirement is greater than 0.5" w.g. (125 Pa) at rated airflow.

A
SINGLE DUCT TERMINAL UNITS

Performance Data • Discharge Sound Power Levels

30HQ Series • Hospital Grade • Dissipative Silencer

Terminal: Steri-Liner • Silencer: Mylar, Spacer, Steri-Liner (MSSL) Media



Inlet Size	Airflow		Min. inlet ΔPs		Sound Power Octave Bands @ Inlet Pressure (ΔPs) shown																																									
					Minimum ΔPs							0.5" w.g. (125Pa) ΔPs							1.0" w.g. (250Pa) ΔPs							1.5" w.g. (375Pa) ΔPs							2.0" w.g. (500Pa) ΔPs							3.0" w.g. (750Pa) ΔPs						
					2	3	4	5	6	7	2	3	4	5	6	7	2	3	4	5	6	7	2	3	4	5	6	7	2	3	4	5	6	7	2	3	4	5	6	7						
4	200	94	0.38	94	57	52	48	44	25	34	59	57	57	52	30	34	62	59	57	50	30	37	65	62	58	51	32	39	65	62	59	52	34	42	66	64	62	55	36	45						
	150	71	0.21	52	55	47	43	35	-	25	57	54	49	42	23	27	61	56	53	45	26	32	62	58	55	48	29	37	62	60	57	49	31	40	61	60	59	54	34	43						
	100	47	0.11	28	52	42	35	27	-	-	55	49	44	36	-	21	58	52	48	41	22	29	57	54	52	45	27	34	57	54	53	49	30	37	57	54	55	52	35	43						
	50	24	0.05	12	52	41	22	-	-	-	53	44	40	33	-	-	55	46	45	40	-	28	55	46	47	40	25	33	55	47	47	42	27	36	55	47	47	42	29	37						
5	350	165	0.17	41	59	52	45	41	25	33	63	58	54	51	33	34	66	62	58	53	36	39	68	64	60	54	38	42	69	65	61	55	39	43	71	67	62	57	40	46						
	250	118	0.10	25	57	47	39	36	-	23	60	56	48	43	25	27	64	59	51	47	28	34	66	62	53	49	30	38	66	63	55	50	32	40	67	65	58	52	34	44						
	150	71	0.03	7	55	42	29	-	-	-	57	49	40	35	-	23	61	54	45	40	20	30	62	56	49	43	24	36	62	57	51	45	26	38	62	57	54	52	32	42						
	100	47	0.02	5	55	41	21	-	-	-	56	46	39	32	-	21	58	49	44	40	22	30	59	50	47	42	27	36	59	51	48	44	28	38	59	51	50	48	31	42						
6	500	236	0.05	13	52	46	41	40	31	30	61	56	50	50	39	38	64	60	54	53	41	41	67	64	57	55	42	44	70	66	60	57	44	47	72	68	62	59	45	49						
	400	189	0.05	12	51	41	37	34	24	24	60	54	47	46	34	33	63	58	51	49	37	37	66	61	54	52	39	41	68	63	57	54	41	44	69	65	59	56	42	47						
	300	142	0.03	6	52	37	32	28	-	20	59	51	44	42	29	30	62	55	48	46	32	35	65	58	51	49	34	39	66	60	54	51	36	42	66	61	56	53	37	45						
	200	94	0.01	3	52	37	27	-	-	20	56	46	40	38	24	28	58	50	44	41	26	32	59	53	47	44	28	35	60	54	50	50	32	40	61	55	53	55	36	44						
7	700	330	0.03	7	57	52	47	43	33	33	64	59	53	50	41	41	67	62	56	52	42	45	70	66	60	55	43	48	72	68	62	57	44	50	74	71	65	59	45	52						
	550	260	0.04	10	55	47	42	37	24	25	61	56	49	45	35	37	65	59	53	48	36	40	68	63	56	51	38	43	70	66	59	53	39	46	71	68	62	55	41	49						
	400	189	0.01	2	53	42	36	30	-	21	59	53	46	41	29	32	63	57	50	45	31	37	67	61	53	48	33	41	67	63	56	50	34	44	68	64	59	52	36	47						
	250	118	0.01	2	51	38	29	-	-	-	56	47	41	35	22	27	57	51	44	39	24	32	58	54	47	42	28	37	60	55	50	46	30	41	60	57	52	49	32	45						
8	1100	519	0.02	4	67	64	58	53	42	43	70	66	61	54	48	49	73	69	63	56	49	52	75	71	65	57	49	55	78	74	67	59	49	57	80	77	70	62	50	58						
	900	425	0.01	3	64	60	52	47	35	36	68	63	56	49	43	45	71	66	59	52	43	48	74	69	62	54	44	51	76	72	65	56	44	53	78	75	67	59	45	54						
	700	330	0.01	2	60	55	46	40	25	27	64	59	51	45	36	40	68	63	55	48	36	43	72	67	59	51	37	46	74	70	62	53	38	48	75	73	64	55	39	51						
	500	236	0.01	2	55	46	37	29	-	21	61	55	47	39	26	32	65	60	51	43	28	37	69	64	55	46	30	41	70	66	58	48	31	45	70	68	61	51	33	48						
9	1400	661	0.01	2	66	62	56	53	47	47	70	66	60	55	52	53	73	69	62	57	52	56	76	71	65	58	53	59	78	74	67	60	54	60	80	77	69	62	54	62						
	1150	543	0.01	2	62	56	49	45	36	35	66	61	55	49	45	46	69	64	58	51	46	49	73	67	60	53	47	53	75	70	63	55	47	54	77	73	65	56	48	56						
	900	425	0.01	2	58	52	43	39	28	27	63	58	51	45	39	41	67	62	54	47	40	45	71	65	57	49	41	48	72	68	60	51	42	50	74	71	63	53	43	52						
	650	307	0.01	2	53	44	36	30	-	20	60	54	46	40	31	35	64	58	50	43	33	39	68	63	53	45	34	43	68	65	56	47	36	46	69	67	59	49	38	49						
10	1500	708	0.02	5	64	58	49	48	44	42	69	64	55	52	51	51	72	67	58	53	52	54	75	70	61	55	53	57	77	73	63	56	53	59	79	75	65	57	54	60						
	1100	519	0.02	4	59	51	41	39	31	27	64	59	50	46	43	42	68	62	53	47	44	47	71	65	56	49	46	51	73	68	58	50	46	52	75	71	61	52	47	53						
	700	330	0.01	2	53	42	32	26	19	19	59	53	43	38	31	33	63	57	47	40	33	38	66	61	50	41	35	42	67	64	53	43	37	45	68	66	56	45	40	48						
	215	101	0.01	1	52	39	-	-	-	-	49	43	29	-	-	21	50	45	34	29	26	30	50	47	39	29	26	38	51	48	40	31	29	42	51	48	41	32	32	45						
12	2500	1180	0.04	10	67	59	52	51	54	52	74	67	58	55	58	59	77	69	61	56	59	62	79	71	64	58	60	64	81	73	66	60	61	66	82	75	67	61	62	68						
	2050	967	0.03	7	64	55	48	47	49	46	71	64	55	51	55	54	73	66	58	53	56	57	75	68	61	54	57	60	77	71	62	56	59	62	79	73	64	58	60	64						
	1600	755	0.02	6	62	50	42	43	41	37	68	59	50	47	50	48	71	62	53	49	52	51	73	66	57	51	54	55	75	68	59	52	55	57	76	70	60	53	56	58						
	1150	543	0.02	4	54	43	36	35	28	24	61	54	45	42	42	40	65	58	48	44	45	44	68	62	51	46	47	48	70	64	54	47	49	50	72	66	57	49	51	53						
14	2650	1251	0.02	5	62	56	52	51	50	47	70	63	57	55	57	56	73	66	60	56	58	59	75	68	64	58	60	62	77	71	67	61	61	64	78	73	70	64	63	66						
	2100	991	0.02	4	58	51	47	46	43	39	66	59	54	51	53	51	69	63	58	53	55	54	72	66	61	56	57	57	75	69	64	58	59	60	77	71	67	61	60	62						
	1550	731	0.01	2	56	48	47	46	38	30	65	59	58	58	54	49	69	64	63	62	57	53	73	68	67	66	60	56	75	71	70	69	63	60	77	73	73	71	66	63						
	1000	472	0.01	2	51	38	30	23	-	-	57	50	45	40	37	36	61	54	49	44	42	41	65	58	54	47	46	46	66	60	57	50	49	50	67	62	60	52	52	54						
16	3725	1758	0.14	36	65	58	53	54	55	53	70	63	58	58	59	59	74	67	62	59	60	62	77	71	65	60	61	64	79	73	67	61	63	66	81	75	69	62	64	68						
	2800	1321	0.12	30	58	52	47	49	49	45	67	60	54	52	54	52	70	64	58	54	56	56	73	67	61	55	57	59	75	70	63	57	59	61	77	72	65	58	60	63						
	1800	849	0.05	12	49	42	38	38	32	27	60	55	48	45	44	42	63	58	51	47	48	47	67	61	54	49	51	51	69</																	

Performance Data • Radiated Sound Power Levels

30HQ Series • Hospital Grade • Dissipative Silencer

Terminal: Steri-Liner • Silencer: Mylar, Spacer, Steri-Liner (MSSL) Media



A

SINGLE DUCT TERMINAL UNITS

Inlet Size	Airflow		Min. inlet ΔPs		Sound Power Octave Bands @ Inlet Pressure (ΔPs) shown																																									
					Minimum ΔPs							0.5" w.g. (125Pa) ΔPs							1.0" w.g. (250Pa) ΔPs							1.5" w.g. (375Pa) ΔPs							2.0" w.g. (500Pa) ΔPs							3.0" w.g. (750Pa) ΔPs						
					2	3	4	5	6	7	2	3	4	5	6	7	2	3	4	5	6	7	2	3	4	5	6	7	2	3	4	5	6	7	2	3	4	5	6	7						
4	200	94	0.38	94	-	36	33	32	-	-	-	39	37	38	29	29	49	46	43	37	30	29	53	52	47	40	32	31	53	53	50	42	33	33	54	55	53	47	37	37						
	150	71	0.21	52	-	35	29	31	-	-	-	40	36	30	25	23	47	46	40	34	28	26	49	50	47	39	31	30	47	48	48	43	34	32	48	48	48	50	40	37						
	100	47	0.11	28	-	-	-	-	-	-	-	37	32	27	-	-	-	43	42	34	27	23	-	44	45	41	32	29	-	43	46	46	36	32	-	42	44	51	43	38						
	50	24	0.05	12	-	-	-	-	-	-	-	37	38	30	-	-	-	36	41	40	32	27	-	35	40	43	38	31	-	34	38	40	38	33	-	32	36	37	35	37						
5	350	165	0.17	41	48	39	33	32	30	27	52	45	39	38	37	32	55	48	45	38	36	32	59	51	49	40	39	34	61	54	51	42	40	36	61	57	55	45	44	40						
	250	118	0.10	25	-	35	31	25	23	-	50	40	36	32	30	25	54	45	42	33	32	28	55	48	45	35	35	30	56	51	48	37	37	32	57	53	51	42	41	35						
	150	71	0.03	7	-	-	-	-	-	-	49	35	31	23	20	-	50	41	39	30	29	21	50	43	43	34	33	27	48	45	45	40	39	31	51	45	46	46	44	37						
	100	47	0.02	5	-	-	-	-	-	-	-	33	29	-	-	-	-	39	38	28	26	-	-	40	42	36	34	26	46	40	43	43	41	31	47	41	43	47	46	37						
6	500	236	0.05	13	48	44	38	36	30	28	49	48	42	40	33	30	57	52	46	41	35	32	60	54	49	45	36	34	62	57	51	45	40	38	65	59	55	47	43	42						
	400	189	0.05	12	-	42	33	33	28	26	49	46	39	35	30	28	56	49	44	38	32	29	59	52	47	40	36	33	62	54	49	42	39	36	64	58	54	45	42	41						
	300	142	0.03	6	-	34	27	26	-	-	47	42	35	29	25	-	55	46	40	33	30	28	58	49	44	36	33	32	59	51	47	38	36	34	60	55	51	43	39	39						
	200	94	0.01	3	-	-	-	-	-	-	47	36	30	24	-	-	53	43	38	30	29	28	53	45	43	32	31	30	53	47	44	36	32	32	55	49	46	43	37	37						
7	700	330	0.03	7	49	46	48	37	33	32	49	48	45	37	31	30	56	51	47	40	34	31	62	57	52	45	37	34	66	60	55	48	40	37	68	64	60	52	44	42						
	550	260	0.04	10	48	43	41	33	27	25	48	44	40	32	28	26	55	49	45	38	32	30	61	54	49	43	36	33	64	58	52	45	38	36	65	61	57	50	42	40						
	400	189	0.01	2	46	39	33	33	-	-	46	43	38	30	26	20	53	48	43	37	31	29	57	51	46	41	34	32	59	53	49	44	36	34	60	56	52	47	40	40						
	250	118	0.01	2	-	-	20	31	-	-	-	39	34	28	21	-	51	46	41	35	29	27	54	47	43	38	31	30	53	48	44	40	33	32	53	49	46	43	37	38						
8	1100	519	0.02	4	52	50	45	37	34	33	57	51	46	37	35	32	60	54	51	40	38	33	65	57	53	43	42	36	67	60	56	45	44	39	70	63	60	49	48	42						
	900	425	0.01	3	51	47	40	34	31	29	56	50	45	37	34	31	58	53	49	39	37	33	63	56	51	42	42	36	65	58	54	44	44	39	68	60	56	47	48	42						
	700	330	0.01	2	50	43	37	31	29	25	51	47	42	33	31	28	57	51	47	37	36	32	61	53	50	40	39	35	63	55	51	42	41	37	64	59	56	45	44	40						
	500	236	0.01	2	-	38	30	27	24	-	50	44	39	31	29	25	55	48	44	35	34	31	58	51	47	37	37	33	59	53	49	39	39	36	61	55	52	43	43	40						
9	1400	661	0.01	2	51	46	46	44	37	35	52	47	46	41	38	35	57	53	49	42	37	35	64	58	53	47	41	37	66	63	57	50	43	40	69	67	61	54	47	44						
	1150	543	0.01	2	50	45	44	41	34	34	51	46	45	40	36	33	56	52	47	41	36	34	62	56	51	45	39	37	64	61	55	49	42	39	67	64	59	52	46	43						
	900	425	0.01	2	48	40	39	36	30	29	50	45	42	37	32	30	56	50	45	40	35	33	60	54	49	44	39	36	63	58	52	47	41	38	64	61	56	50	44	42						
	650	307	0.01	2	47	36	31	28	21	-	49	41	36	31	28	25	54	48	42	37	32	30	57	51	46	41	35	33	59	54	49	44	38	36	60	57	52	47	41	39						
10	1500	708	0.02	5	54	43	43	38	34	26	56	48	46	39	35	30	58	53	50	44	38	34	62	57	53	48	42	38	64	59	55	50	45	41	66	64	59	54	48	45						
	1100	519	0.02	4	51	37	35	30	25	-	53	46	42	35	31	27	55	50	47	41	35	31	60	54	50	45	39	36	61	56	51	47	42	39	64	61	55	51	45	43						
	700	330	0.01	2	-	30	25	21	-	-	48	42	37	31	27	24	53	47	42	37	33	29	56	50	45	41	36	33	58	51	47	43	38	36	59	55	50	48	41	40						
	215	101	0.01	1	-	-	-	-	-	-	36	32	25	23	-	-	45	36	29	28	26	22	46	38	33	31	28	28	49	38	34	33	30	29	49	41	38	37	33	33						
12	2500	1180	0.04	10	57	55	54	50	42	36	60	57	53	46	41	38	63	61	54	50	42	39	66	63	57	53	45	41	67	64	59	55	48	44	70	69	63	59	52	50						
	2050	967	0.03	7	55	50	48	44	37	33	58	55	51	46	39	35	61	59	53	49	42	37	64	61	56	52	45	41	65	62	58	55	48	44	68	67	61	58	51	49						
	1600	755	0.02	6	52	45	41	36	30	27	56	52	45	40	34	30	59	56	49	46	38	35	61	58	53	49	42	39	62	60	55	51	44	42	65	64	58	55	48	46						
	1150	543	0.02	4	47	38	31	27	23	-	52	48	40	36	30	26	55	52	45	41	34	32	58	55	49	45	38	36	59	57	51	48	41	39	61	60	55	52	45	44						
14	2650	1251	0.02	5	57	53	50	46	42	35	58	56	49	44	40	35	62	60	53	48	45	39	64	63	56	50	47	44	65	66	59	52	49	47	69	69	63	57	52	50						
	2100	991	0.02	4	54	48	44	39	35	30	56	53	46	41	37	31	60	57	50	44	41	38	63	61	55	48	44	43	64	63	57	50	46	45	66	66	60	55	50	48						
	1550	731	0.01	2	46	40	35	30	26	-	51	48	42	35	31	27	57	55	48	40	36	35	60	58	52	45	40	39	60	60	53	47	43	41	62	63	57	52	47	45						
	1000	472	0.01	2	-	-	-	-	-	-	48	45	37	31	28	24	52	51	43	37	33	31	54	53	46	41	37	35	55	56	49	44	40	38	56	57	52	48	43	42						
16	3752	1758	0.14	36	58	58	55	51	45	38	* * * * *	64	62	57	53	48	39	67	66	60	56	50	45	69	69	62	57	51	49	71	72	65	59	53	49											
	2800	1321	0.12	30	54	51	49	43	37	32	59	55	50	44	38	32	62	59	53	47	41	35	65	63	57	50	44	39	66	65	59	52	46	41	68	69	62	56	50	46						
	1800	849	0.05	12	47	40	37	30	24	-	52	49	42	36	32	27	57	55	49	41	36	32	59	59	52	44	39	35	61	61	54	48	42	38	62	64	57	52	46	43						

Performance Data • AHRI Certification and Performance Notes

30HQ Series • Hospital Grade • Dissipative Silencer • AHRI Certification Points

Terminal: Steri-Liner • Silencer: Mylar, Spacer, Steri-Liner (MSSL) Media

Inlet Size	Airflow		Min. Inlet ΔPs		Discharge Sound Power Levels @ 1.5" w.g. (375 Pa) ΔPs							Radiated Sound Power Levels @ 1.5" w.g. (375 Pa) ΔPs						
					Octave Band							Octave Band						
	cfm	l/s	"w.g.	Pa	2	3	4	5	6	7	2	3	4	5	6	7		
4	150	71	0.24	60	62	58	55	48	29	37	49	50	47	39	31	30		
5	250	118	0.08	20	66	62	53	49	30	38	55	48	45	35	35	30		
6	400	189	0.06	15	66	61	54	52	39	41	59	52	47	40	36	33		
7	550	260	0.06	16	68	63	56	51	38	43	61	54	49	43	36	33		
8	700	330	0.08	21	72	67	59	51	37	46	61	53	50	40	39	35		
9	900	425	0.07	17	71	65	57	49	41	48	60	54	49	44	39	36		
10	1100	519	0.14	34	71	65	56	49	46	51	60	54	50	45	39	36		
12	1600	755	0.19	48	73	66	57	51	54	55	61	58	53	49	42	39		
14	2100	991	0.19	46	72	66	61	56	57	57	63	61	55	48	44	43		
16	2800	1321	0.30	75	73	67	61	55	57	59	65	63	57	50	44	39		
24 x 16	5350	2525	0.01	2	87	80	77	72	74	75	72	70	70	65	60	55		



Ratings are certified in accordance with AHRI Standards.

Performance Notes for Sound Power Levels:

- Discharge sound power is the noise emitted from the unit discharge into the downstream duct. Discharge Sound Power Levels (SWL) now include duct end reflection energy as part of the standard rating. Including the duct end correction provides sound power levels that would normally be transmitted into an acoustically, non-reflective duct. The effect of including the energy correction to the discharge SWL, is higher sound power levels when compared to previous AHRI certified data. For more information on duct end reflection calculations see AHRI Standard 880.
- Radiated sound power is the breakout noise transmitted through the unit casing walls.
- Sound power levels are in decibels, dB re 10-12 watts.
- All sound data listed by octave bands is raw data without any corrections for room absorption or duct attenuation. Dash (-) in space indicates sound power level is less than 20 dB or equal to background.
- Minimum inlet ΔPs is the minimum operating pressure requirement of the unit (damper full open) and the difference in static pressure from inlet to discharge of the unit.
- Asterisk (*) in space indicates that the minimum inlet static pressure requirement is greater than 0.5" w.g. (125 Pa) at rated airflow.
- Data derived from independent tests conducted in accordance with ANSI/ASHRAE Standard 130 and AHRI Standard 880.

A

SINGLE DUCT TERMINAL UNITS

Oversized Casing • Larger Hot Water Coils

Models: 30RW, 30RWQ and 30HQW

Nailor offers oversized casing on all Single Duct Terminal Units with hot water reheat. This oversized casing option allows the selection of a standard inlet size with a larger casing. The use of standard larger casing sizes and standard water coils allows standard performance and delivery while taking advantage of increased heat transfer area needed for lower water temperatures.

FEATURES:

- One, two, three and four row available.
- Hot water coils have copper tubes and aluminum ripple fins. Coils have 1/2" (13), 7/8" (22) or 1 3/8" (35) O.D. sweat connections.
- Right or left hand coil connection is determined by looking through the terminal inlet in the direction of airflow.
- Galvanized steel casing with slip and drive discharge duct connection.
- Optional low leakage gasketed access door is recommended for coil access and cleaning.



Model D30RW with Oversized Casing

- AHRI Certified coils.
- Coil Performance data on pages A43-A51.
- Denotes inlet airflow direction.
- Slip and drive cleat duct connection.
- For special outlet sizes and arrangements, consult your Nailor representative.

Dimensions

Model 30RW • Hot Water Reheat Coil

Digital and Analog Electronic Controls

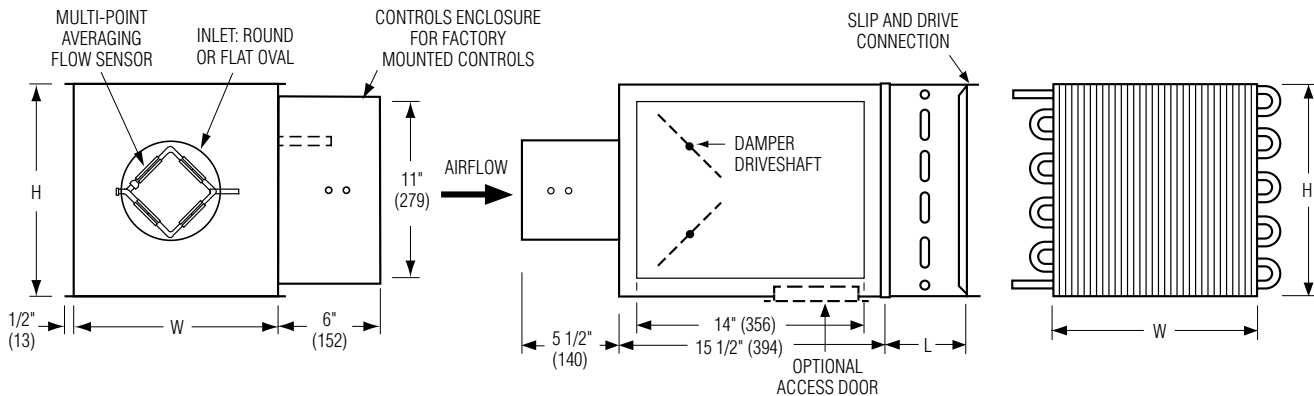

Digital and Analog Electronic Controls with Bottom Mount Controls location

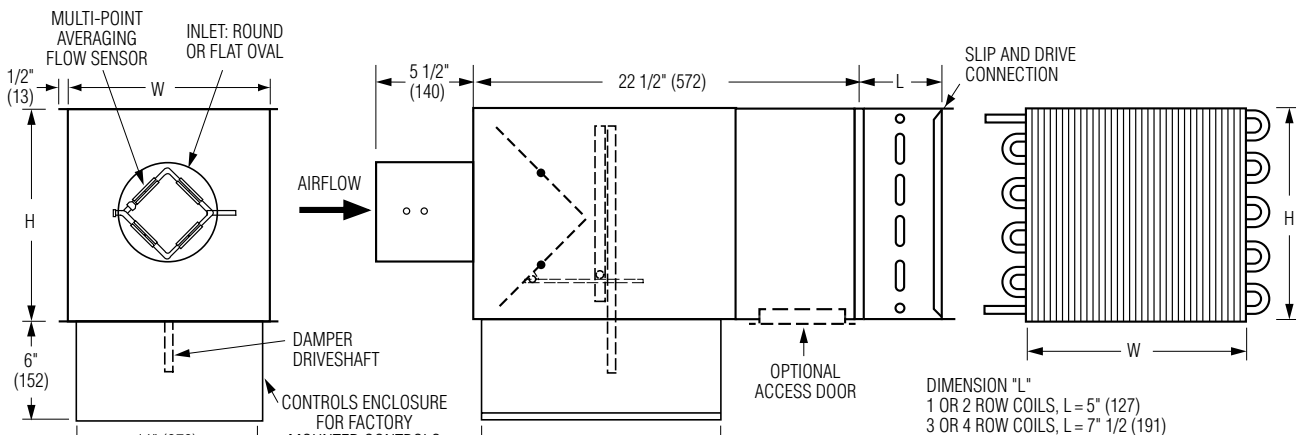

A SINGLE DUCT TERMINAL UNITS

Dimensions

Pneumatic Controls

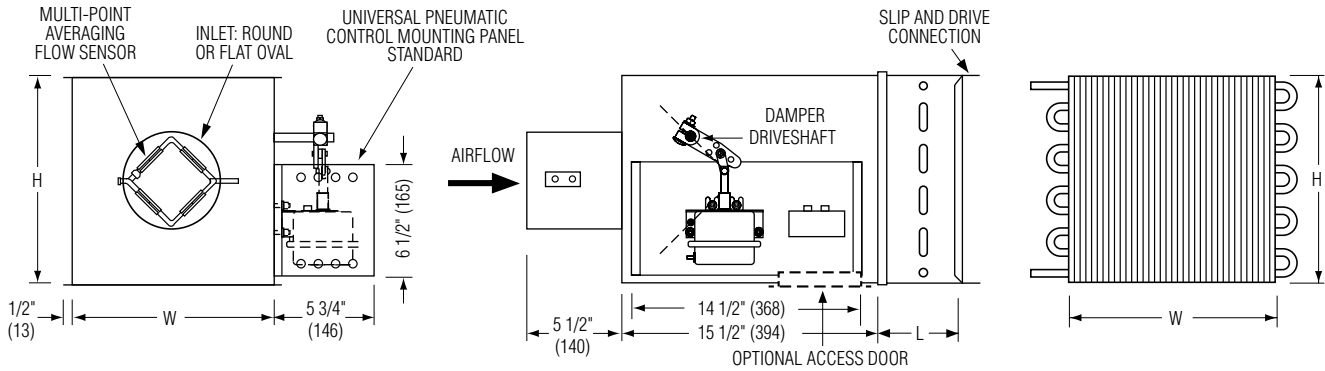

Model 30RW • Integral Attenuator plus Hot Water Reheat Coil

- All the benefits of both the Integral Sound Attenuator and the Hot Water Coils in one.
- Coil performance data on pages A43-A51.

Digital and Analog Controls

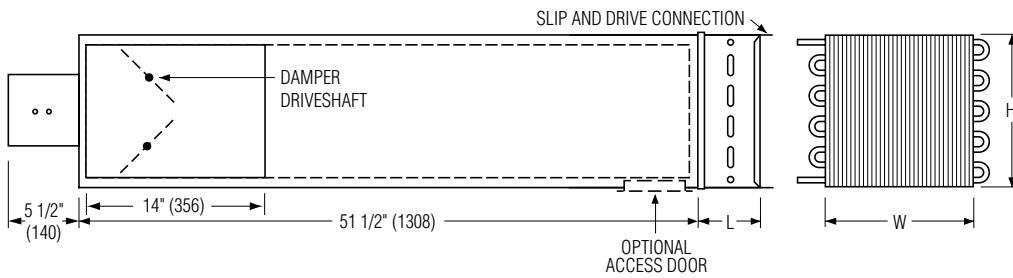

Digital and Analog Controls with Bottom Mount Controls Location

- Single continuous length terminal construction minimizes casing leakage.
- Continuous internal insulation reduces insulation seams and minimizes airflow disturbance.
- Supplied with same liner as basic unit.

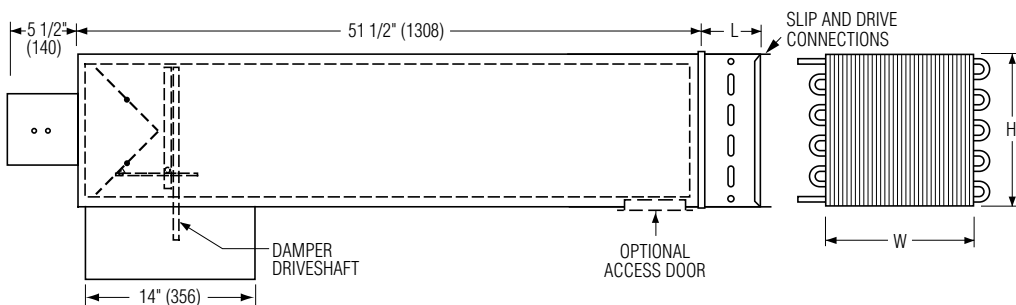

Dimensions

Model 30RWQ

Digital and Analog Controls

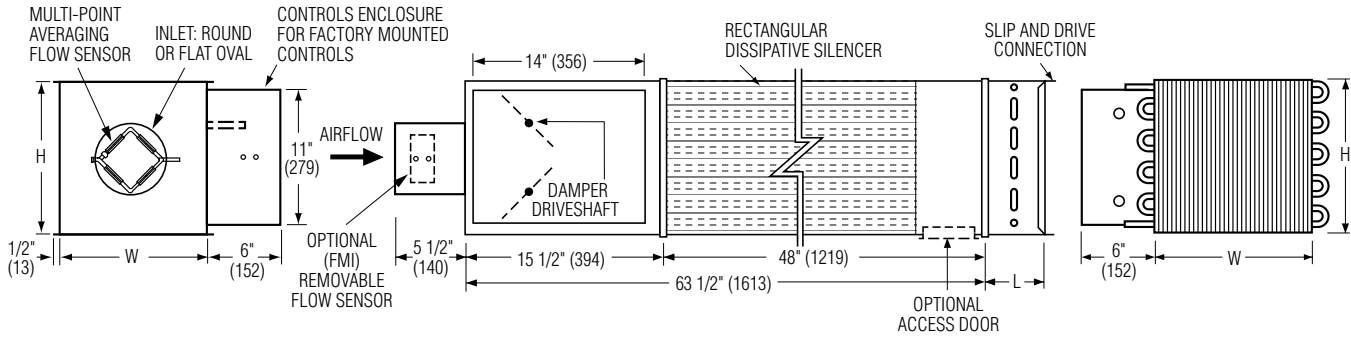

Model 30HQW

Digital and Analog Controls

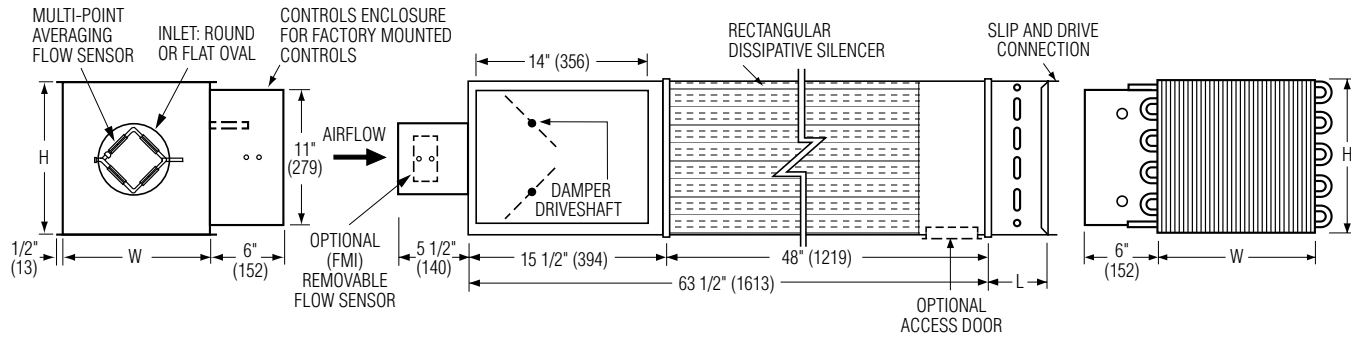

Dimensional Data

Unit Size	Inlet Size	W	H	Inlet Size (Nominal)	Coil Connections			
					1 Row	2 Row	3 Row	4 Row
8	4	12 (305)	12 1/2 (318)	3 7/8 (98) Round	1/2 (13)	7/8 (22)	7/8 (22)	7/8 (22)
	5			4 7/8 (124) Round	1/2 (13)	7/8 (22)	7/8 (22)	7/8 (22)
	6			5 7/8 (149) Round	1/2 (13)	7/8 (22)	7/8 (22)	7/8 (22)
10	7	14 (356)	12 1/2 (318)	6 7/8 (175) Round	1/2 (13)	7/8 (22)	7/8 (22)	7/8 (22)
	8			7 7/8 (200) Round	1/2 (13)	7/8 (22)	7/8 (22)	7/8 (22)
12	9	18 (457)	12 1/2 (318)	8 7/8 (225) Round	1/2 (13)	7/8 (22)	7/8 (22)	7/8 (22)
	10			9 7/8 (251) Round	1/2 (13)	7/8 (22)	7/8 (22)	7/8 (22)
14	12	24 (610)	12 1/2 (318)	12 15/16 x 9 13/16 (329 x 249) Oval	1/2 (13)	7/8 (22)	7/8 (22)	7/8 (22)
16	14	28 (711)	12 1/2 (318)	16 1/16 x 9 13/16 (408 x 249) Oval	7/8 (22)	7/8 (22)	7/8 (22)	7/8 (22)
24	16	38 (965)	18 (457)	19 3/16 x 9 13/16 (487 x 249) Oval	7/8 (22)	7/8 (22)	1 3/8 (35)	1 3/8 (35)

A SINGLE DUCT TERMINAL UNITS

Performance Data • Hot Water Coil • Capacities

Models: 30RW, 30RWQ and 30HQW

Unit Sizes 4, 5 and 6

1 Row (single circuit)

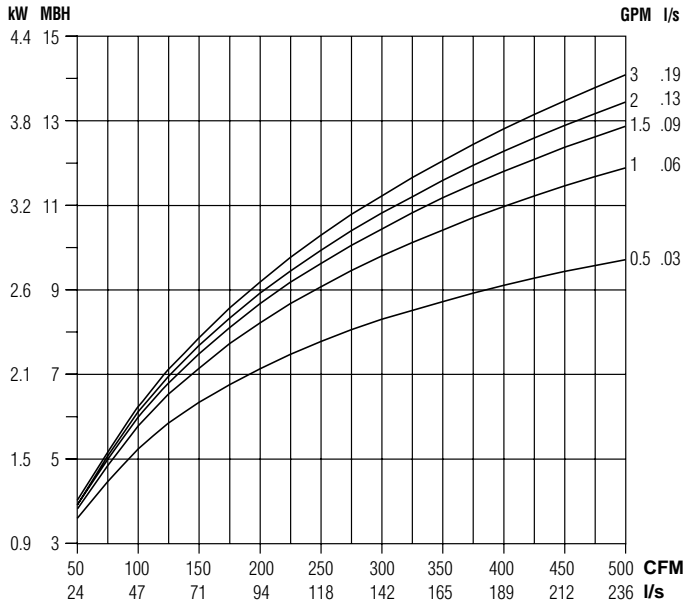

2 Row (multi-circuit)

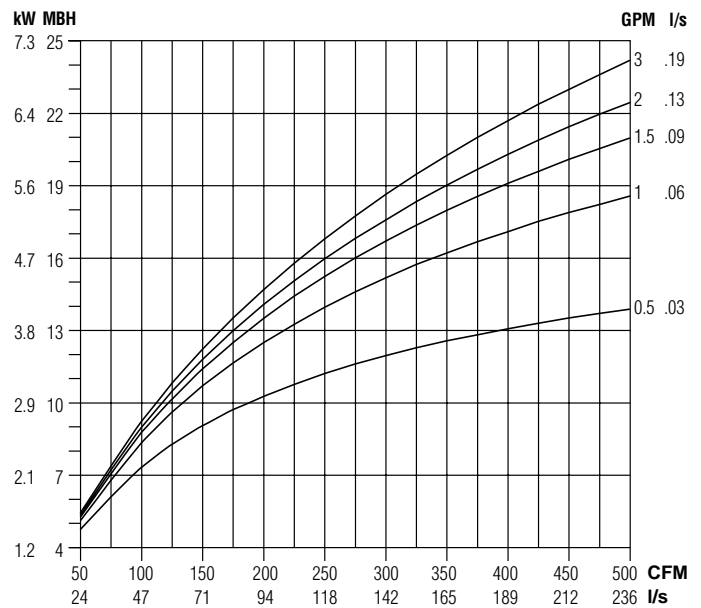

3 Row (multi-circuit)

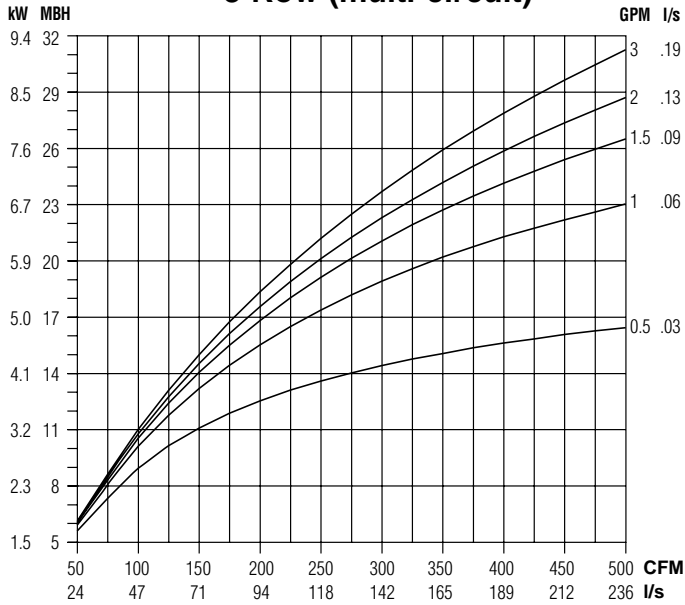

4 Row (multi-circuit)

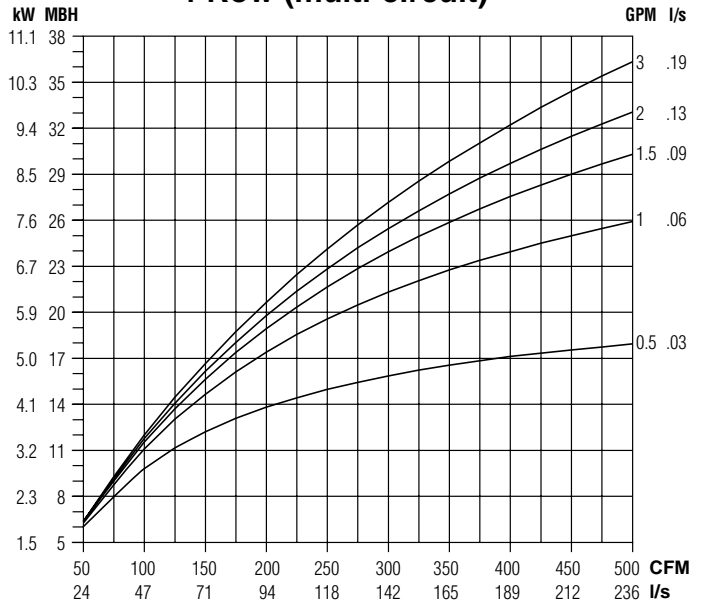

NOTES:

- Capacities are in MBH (kW), *thousands of Btu per hour (kiloWatts)*.
- MBH (kW) values are based on a Δt (temperature difference) of 125°F (69°C) between entering air and entering water. For other Δt 's; multiply the MBH (kW) values by the factors below.

- Air Temperature Rise.
 $ATR (^\circ F) = 927 \times \frac{MBH}{cfm}$, $ATR (^\circ C) = 829 \times \frac{kW}{l/s}$
- Water Temp. Drop.
 $WTD (^\circ F) = 2.04 \times \frac{MBH}{GPM}$, $WTD (^\circ C) = .224 \times \frac{kW}{l/s}$
- Connections: 1 Row 1/2" (13), 2, 3 and 4 Row 7/8" (22); O.D. male solder.

Altitude Correction Factors:

Altitude ft. (m)	Sensible Heat Factor
0 (0)	1.00
2000 (610)	0.94
3000 (914)	0.90
4000 (1219)	0.87
5000 (1524)	0.84
6000 (1829)	0.81
7000 (2134)	0.78

Correction factors at other entering conditions:

Δt °F (°C)	40 (22)	50 (28)	60 (33)	70 (39)	80 (44)	90 (50)	100 (56)	110 (61)	125 (69)	140 (78)	160 (89)	180 (100)
Factor	.320 (.319)	.400 (.406)	.480 (.478)	.560 (.565)	.640 (.638)	.720 (.725)	.800 (.812)	.880 (.884)	1.00 (1.00)	1.12 (1.13)	1.28 (1.29)	1.44 (1.45)

Performance Data • Hot Water Coil • Capacities

Models: 30RW, 30RWQ and 30HQW

Unit Sizes 7 and 8

1 Row (single circuit)

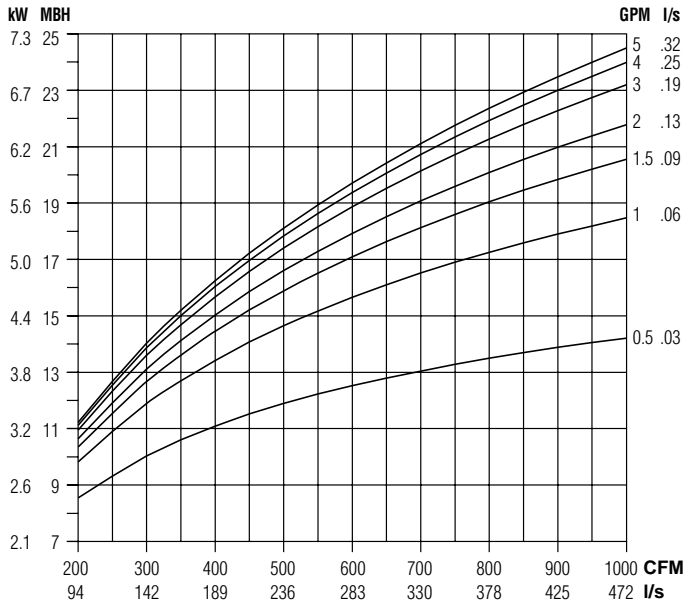

2 Row (multi-circuit)

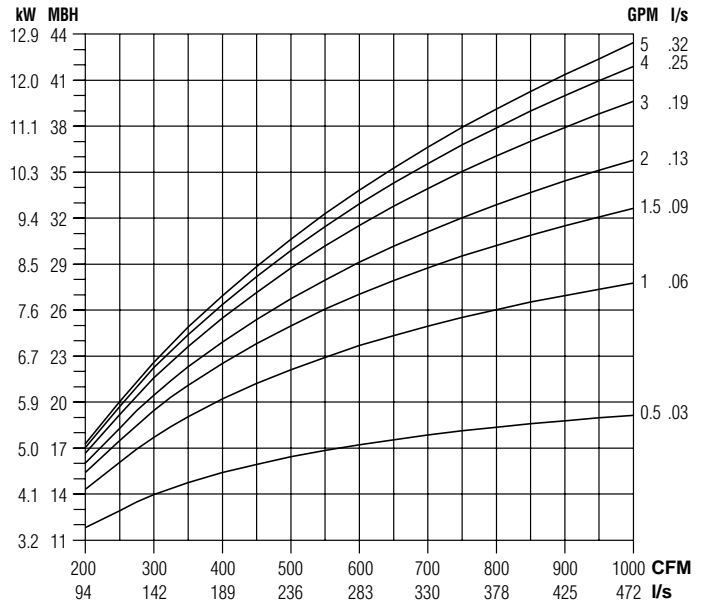

3 Row (multi-circuit)

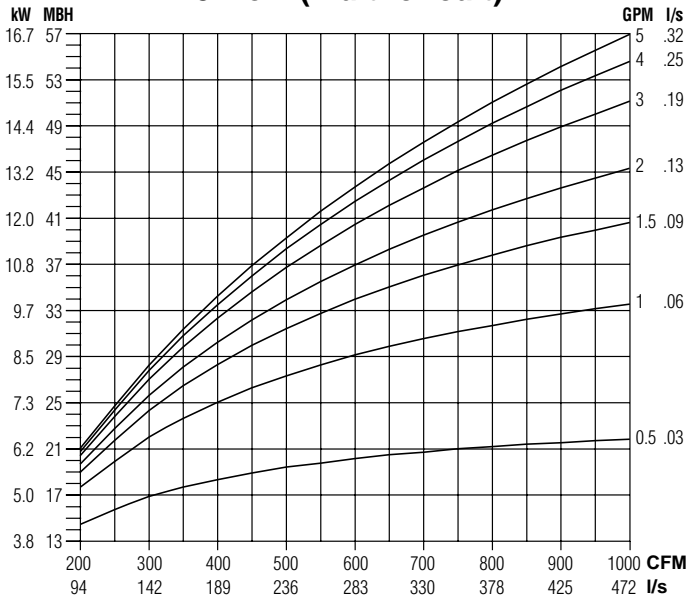

4 Row (multi-circuit)

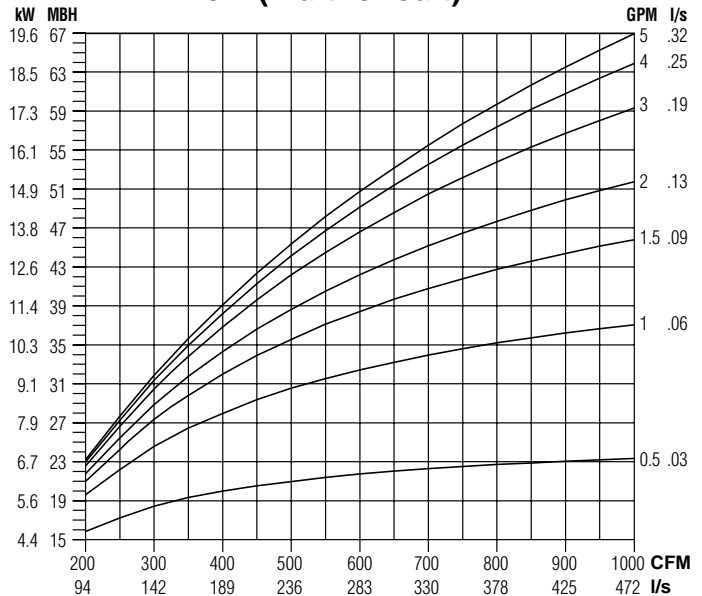

NOTES:

- Capacities are in MBH (kW), **thousands of Btu per hour (kiloWatts)**.
- MBH (kW) values are based on a Δt (temperature difference) of 125°F (69°C) between entering air and entering water. For other Δt 's; multiply the MBH (kW) values by the factors below.

- Air Temperature Rise.

$$\text{ATR (}^\circ\text{F)} = 927 \times \frac{\text{MBH}}{\text{cfm}}, \text{ ATR (}^\circ\text{C)} = 829 \times \frac{\text{kW}}{\text{l/s}}$$

- Water Temp. Drop.

$$\text{WTD (}^\circ\text{F)} = 2.04 \times \frac{\text{MBH}}{\text{GPM}}, \text{ WTD (}^\circ\text{C)} = .224 \times \frac{\text{kW}}{\text{l/s}}$$

- Connections: 1 Row 1/2" (13), 2, 3 and 4 Row 7/8" (22); O.D. male solder.

Altitude Correction Factors:

Altitude ft. (m)	Sensible Heat Factor
0 (0)	1.00
2000 (610)	0.94
3000 (914)	0.90
4000 (1219)	0.87
5000 (1524)	0.84
6000 (1829)	0.81
7000 (2134)	0.78

Correction factors at other entering conditions:

Δt °F (°C)	40 (22)	50 (28)	60 (33)	70 (39)	80 (44)	90 (50)	100 (56)	110 (61)	125 (69)	140 (78)	160 (89)	180 (100)
Factor	.320 (.319)	.400 (.406)	.480 (.478)	.560 (.565)	.640 (.638)	.720 (.725)	.800 (.812)	.880 (.884)	1.00 (1.00)	1.12 (1.13)	1.28 (1.29)	1.44 (1.45)

A

SINGLE DUCT TERMINAL UNITS

Performance Data • Hot Water Coil • Capacities

Models: 30RW, 30RWQ and 30HQW

Unit Sizes 9 and 10

1 Row (single circuit)

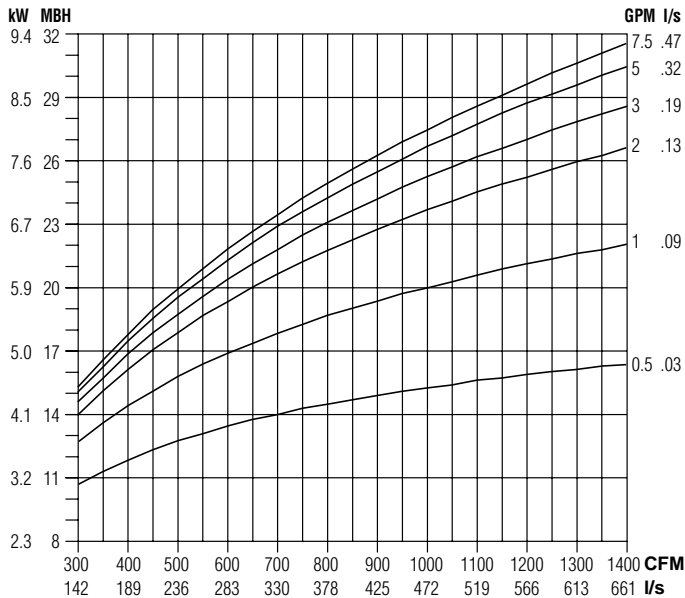

2 Row (multi-circuit)

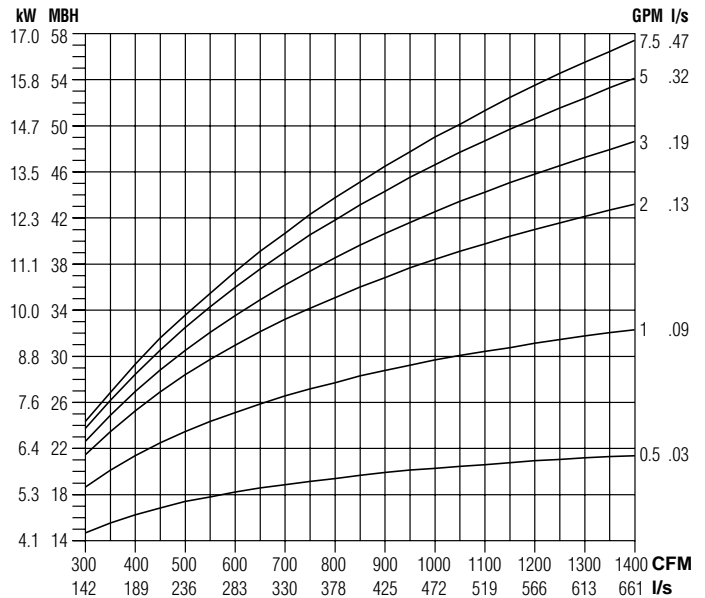

3 Row (multi-circuit)

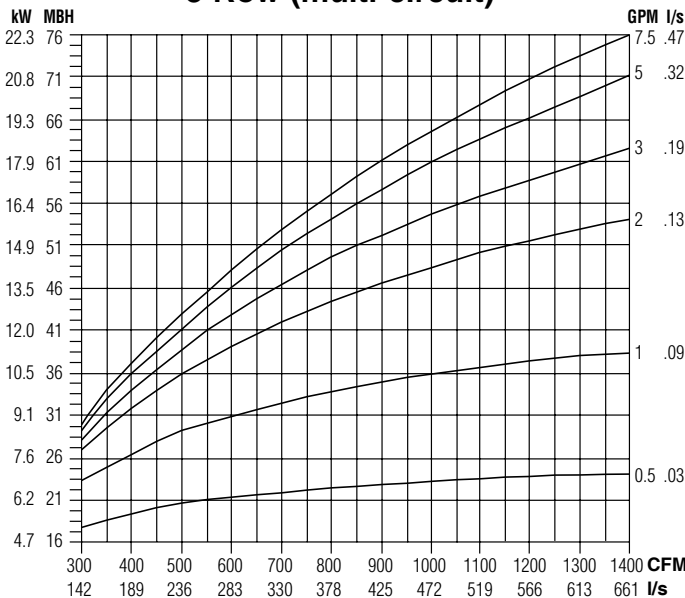

4 Row (multi-circuit)

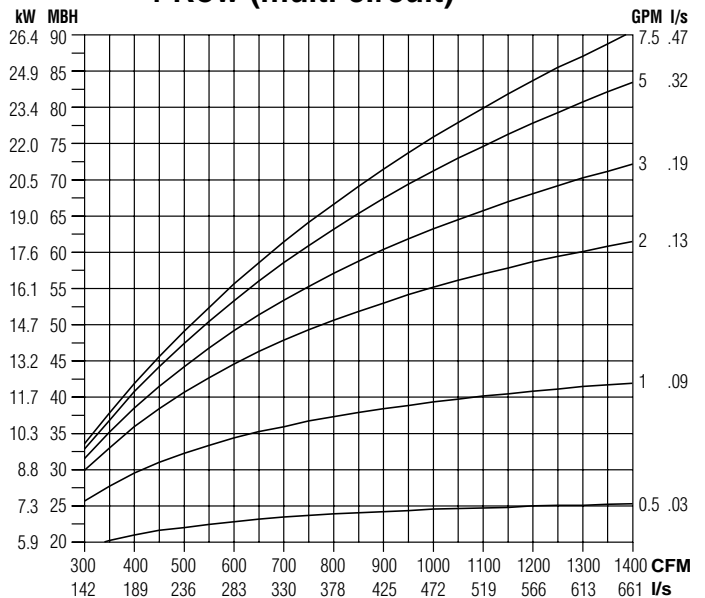

NOTES:

- Capacities are in MBH (kW), *thousands of Btu per hour (kiloWatts)*.
- MBH (kW) values are based on a Δt (temperature difference) of 125°F (69°C) between entering air and entering water. For other Δt 's; multiply the MBH (kW) values by the factors below.

- Air Temperature Rise.
 $ATR (^\circ F) = 927 \times \frac{MBH}{cfm}$, $ATR (^\circ C) = 829 \times \frac{kW}{l/s}$
- Water Temp. Drop.
 $WTD (^\circ F) = 2.04 \times \frac{MBH}{GPM}$, $WTD (^\circ C) = .224 \times \frac{kW}{l/s}$
- Connections: 1 Row 1/2" (13), 2, 3 and 4 Row 7/8" (22); O.D. male solder.

Altitude Correction Factors:

Altitude ft. (m)	Sensible Heat Factor
0 (0)	1.00
2000 (610)	0.94
3000 (914)	0.90
4000 (1219)	0.87
5000 (1524)	0.84
6000 (1829)	0.81
7000 (2134)	0.78

Correction factors at other entering conditions:

Δt °F (°C)	40 (22)	50 (28)	60 (33)	70 (39)	80 (44)	90 (50)	100 (56)	110 (61)	125 (69)	140 (78)	160 (89)	180 (100)
Factor	.320 (.319)	.400 (.406)	.480 (.478)	.560 (.565)	.640 (.638)	.720 (.725)	.800 (.812)	.880 (.884)	1.00 (1.00)	1.12 (1.13)	1.28 (1.29)	1.44 (1.45)

A

SINGLE DUCT TERMINAL UNITS

Performance Data • Hot Water Coil • Capacities

Models: 30RW, 30RWQ and 30HQW

Unit Size 12

1 Row (single circuit)

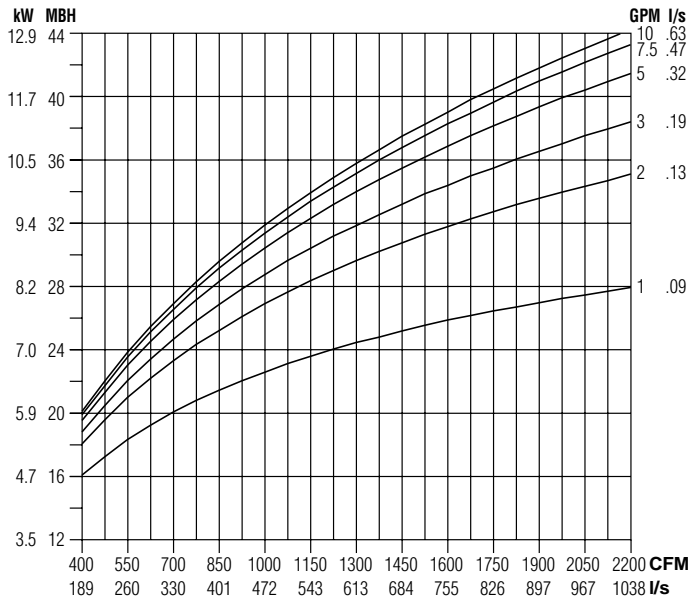

2 Row (multi-circuit)

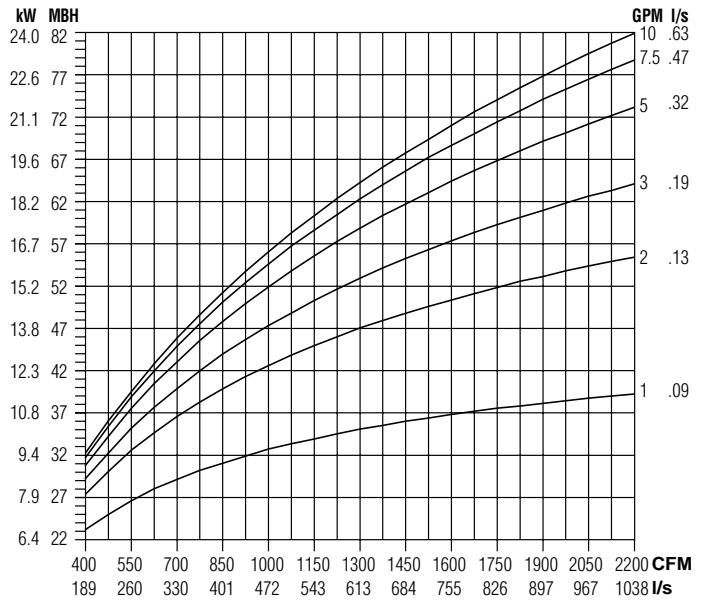

3 Row (multi-circuit)

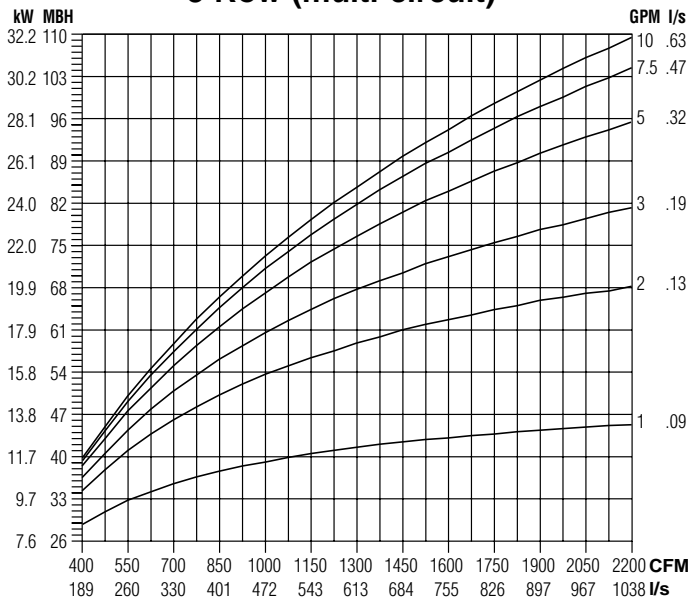

4 Row (multi-circuit)

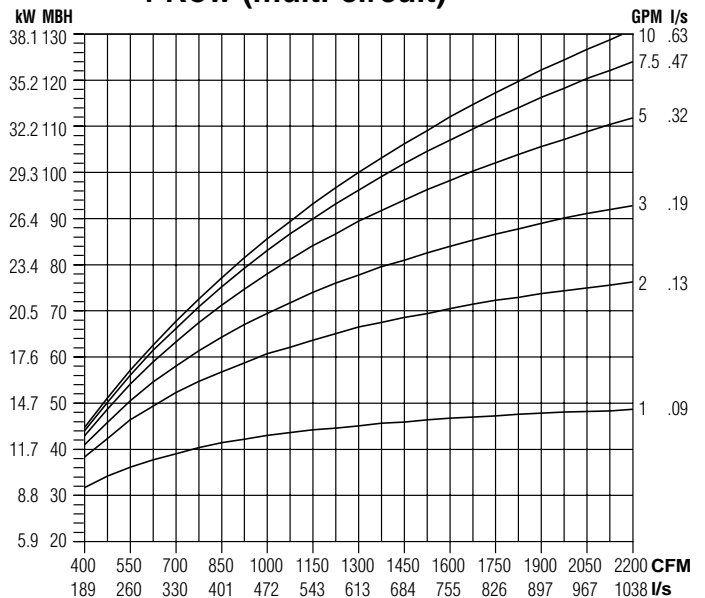

NOTES:

- Capacities are in MBH (kW), *thousands of Btu per hour (kiloWatts)*.
- MBH (kW) values are based on a Δt (temperature difference) of 125°F (69°C) between entering air and entering water. For other Δt 's; multiply the MBH (kW) values by the factors below.

- Air Temperature Rise.

$$\text{ATR (°F)} = 927 \times \frac{\text{MBH}}{\text{cfm}}, \text{ATR (°C)} = 829 \times \frac{\text{kW}}{\text{l/s}}$$

- Water Temp. Drop.

$$\text{WTD (°F)} = 2.04 \times \frac{\text{MBH}}{\text{GPM}}, \text{WTD (°C)} = .224 \times \frac{\text{kW}}{\text{l/s}}$$

- Connections: 1 Row 1/2" (13), 2, 3 and 4 Row 7/8" (22); O.D. male solder.

Altitude Correction Factors:

Altitude ft. (m)	Sensible Heat Factor
0 (0)	1.00
2000 (610)	0.94
3000 (914)	0.90
4000 (1219)	0.87
5000 (1524)	0.84
6000 (1829)	0.81
7000 (2134)	0.78

Correction factors at other entering conditions:

Δt °F (°C)	40 (22)	50 (28)	60 (33)	70 (39)	80 (44)	90 (50)	100 (56)	110 (61)	125 (69)	140 (78)	160 (89)	180 (100)
Factor	.320 (.319)	.400 (.406)	.480 (.478)	.560 (.565)	.640 (.638)	.720 (.725)	.800 (.812)	.880 (.884)	1.00 (1.00)	1.12 (1.13)	1.28 (1.29)	1.44 (1.45)

A

SINGLE DUCT TERMINAL UNITS

Performance Data • Hot Water Coil • Capacities

Models: 30RW, 30RWQ and 30HQW

Unit Size 14

1 Row (single circuit)

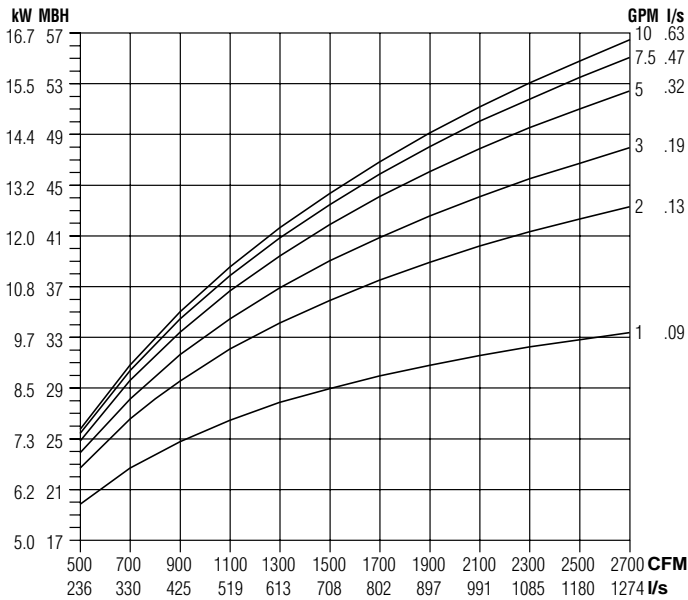

2 Row (multi-circuit)

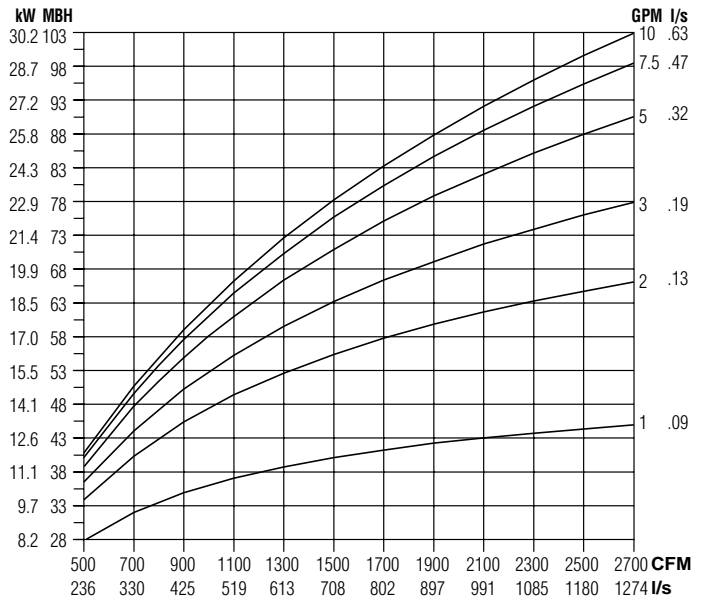

3 Row (multi-circuit)

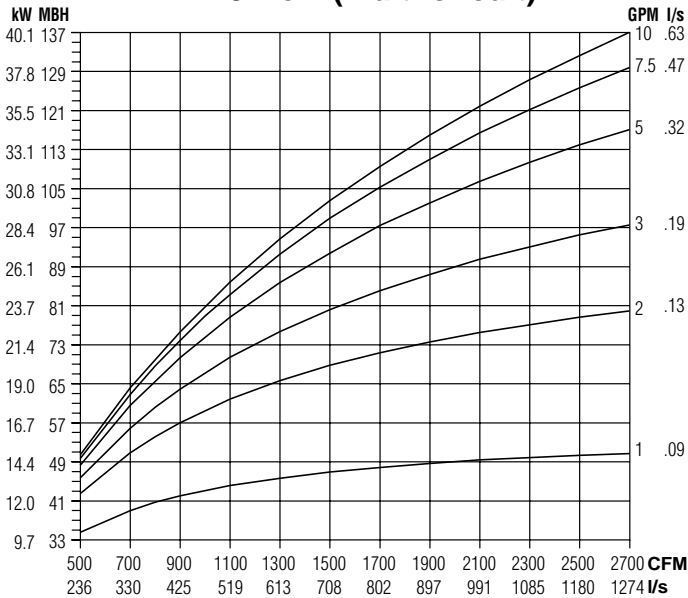

4 Row (multi-circuit)

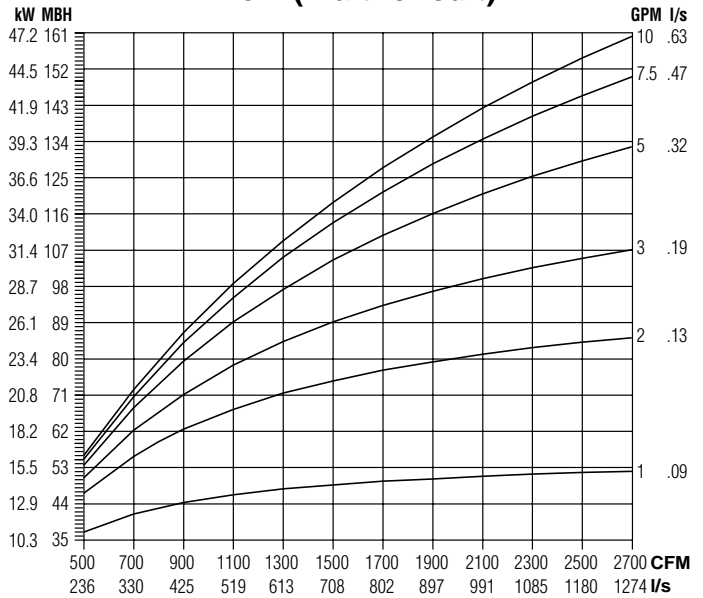

NOTES:

- Capacities are in MBH (kW), *thousands of Btu per hour (kiloWatts)*.
- MBH (kW) values are based on a Δt (temperature difference) of 125°F (69°C) between entering air and entering water. For other Δt 's; multiply the MBH (kW) values by the factors below.

- Air Temperature Rise.

$$\text{ATR (}^\circ\text{F)} = 927 \times \frac{\text{MBH}}{\text{cfm}}, \text{ ATR (}^\circ\text{C)} = 829 \times \frac{\text{kW}}{\text{l/s}}$$

- Water Temp. Drop.

$$\text{WTD (}^\circ\text{F)} = 2.04 \times \frac{\text{MBH}}{\text{GPM}}, \text{ WTD (}^\circ\text{C)} = .224 \times \frac{\text{kW}}{\text{l/s}}$$

- Connections: 1 Row 1/2" (13), 2, 3 and 4 Row 7/8" (22); O.D. male solder.

Altitude Correction Factors:

Altitude ft. (m)	Sensible Heat Factor
0 (0)	1.00
2000 (610)	0.94
3000 (914)	0.90
4000 (1219)	0.87
5000 (1524)	0.84
6000 (1829)	0.81
7000 (2134)	0.78

Correction factors at other entering conditions:

Δt °F (°C)	40 (22)	50 (28)	60 (33)	70 (39)	80 (44)	90 (50)	100 (56)	110 (61)	125 (69)	140 (78)	160 (89)	180 (100)
Factor	.320 (.319)	.400 (.406)	.480 (.478)	.560 (.565)	.640 (.638)	.720 (.725)	.800 (.812)	.880 (.884)	1.00 (1.00)	1.12 (1.13)	1.28 (1.29)	1.44 (1.45)

Performance Data • Hot Water Coil • Capacities

Models: 30RW, 30RWQ and 30HQW

Unit Size 16

1 Row (single circuit)

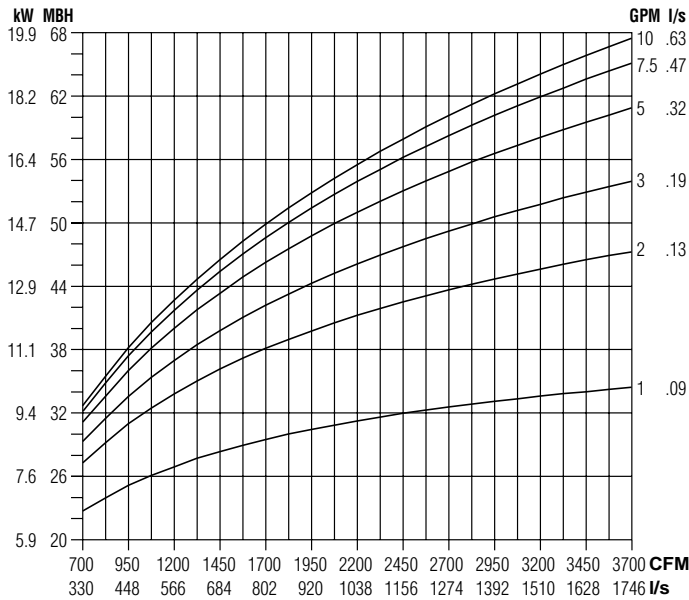

2 Row (multi-circuit)

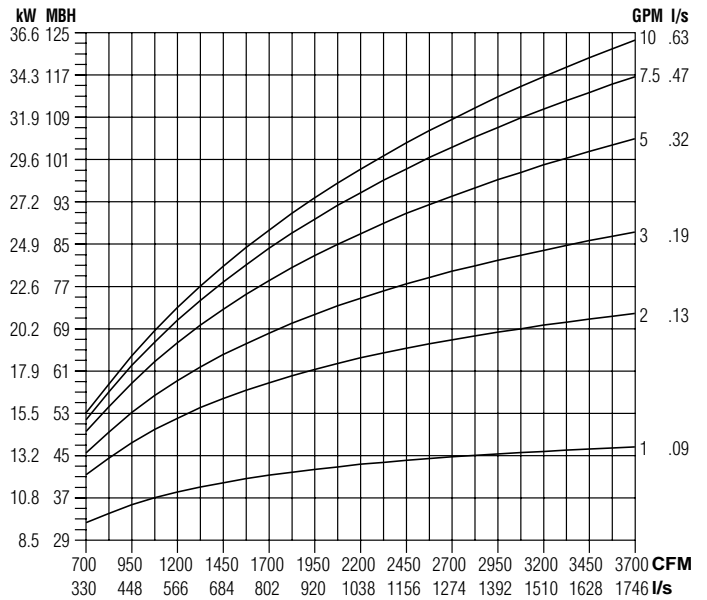

3 Row (multi-circuit)

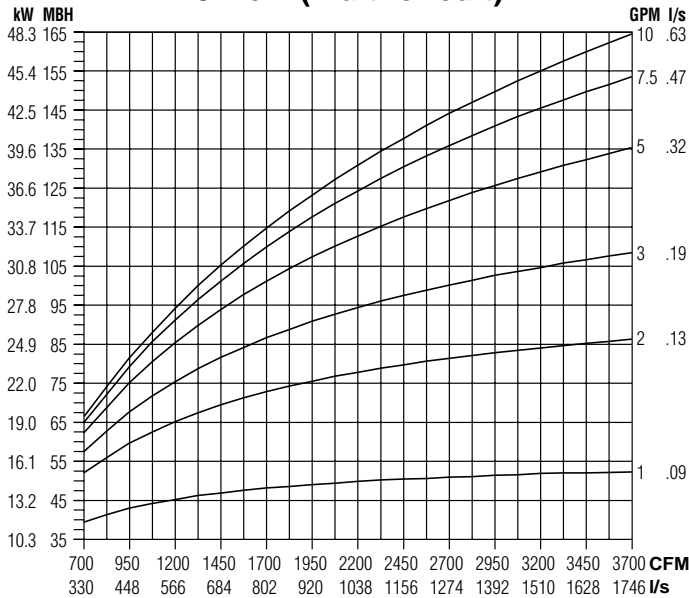

4 Row (multi-circuit)

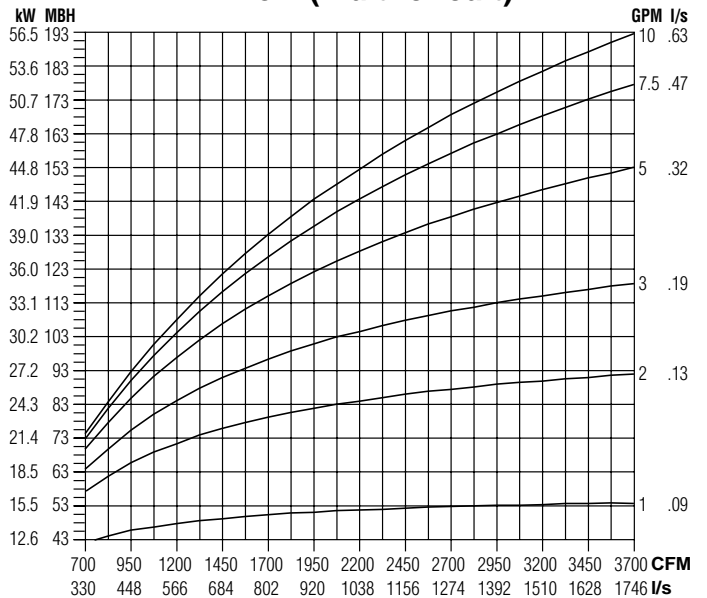

NOTES:

- Capacities are in MBH (kW), *thousands of Btu per hour (kiloWatts)*.
- MBH (kW) values are based on a Δt (temperature difference) of 125°F (69°C) between entering air and entering water. For other Δt 's; multiply the MBH (kW) values by the factors below.

- Air Temperature Rise.

$$\text{ATR (}^\circ\text{F)} = 927 \times \frac{\text{MBH}}{\text{cfm}}, \text{ ATR (}^\circ\text{C)} = 829 \times \frac{\text{kW}}{\text{l/s}}$$

- Water Temp. Drop.

$$\text{WTD (}^\circ\text{F)} = 2.04 \times \frac{\text{MBH}}{\text{GPM}}, \text{ WTD (}^\circ\text{C)} = .224 \times \frac{\text{kW}}{\text{l/s}}$$

- Connections: 1, 2, 3 and 4 Row 7/8" (22); O.D. male solder.

Altitude Correction Factors:

Altitude ft. (m)	Sensible Heat Factor
0 (0)	1.00
2000 (610)	0.94
3000 (914)	0.90
4000 (1219)	0.87
5000 (1524)	0.84
6000 (1829)	0.81
7000 (2134)	0.78

Correction factors at other entering conditions:

Δt °F (°C)	40 (22)	50 (28)	60 (33)	70 (39)	80 (44)	90 (50)	100 (56)	110 (61)	125 (69)	140 (78)	160 (89)	180 (100)
Factor	.320 (.319)	.400 (.406)	.480 (.478)	.560 (.565)	.640 (.638)	.720 (.725)	.800 (.812)	.880 (.884)	1.00 (1.00)	1.12 (1.13)	1.28 (1.29)	1.44 (1.45)

A

SINGLE DUCT TERMINAL UNITS

Performance Data • Hot Water Coil • Capacities

Models: 30RW, 30RWQ and 30HQW

Unit Size 24 x 16

1 Row (single circuit)

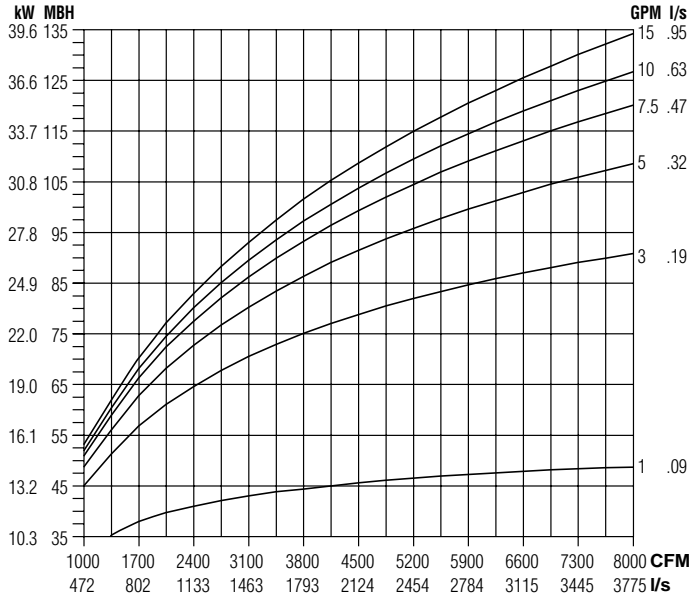

2 Row (multi-circuit)

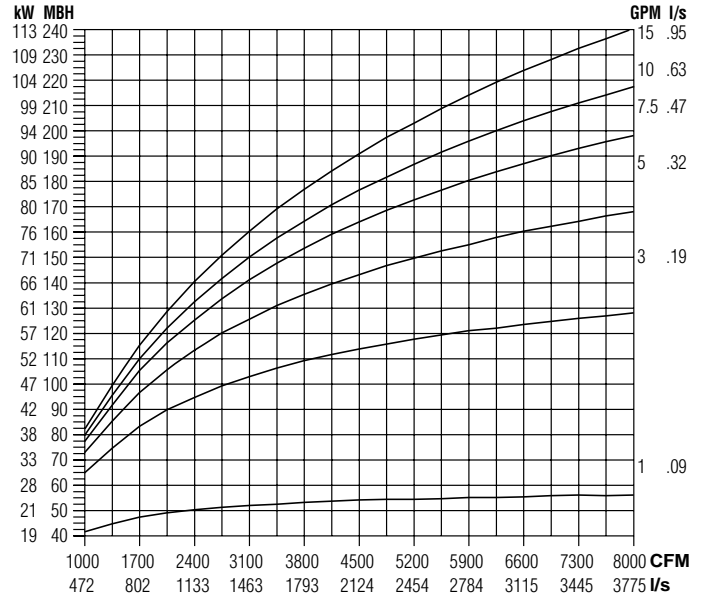

3 Row (multi-circuit)

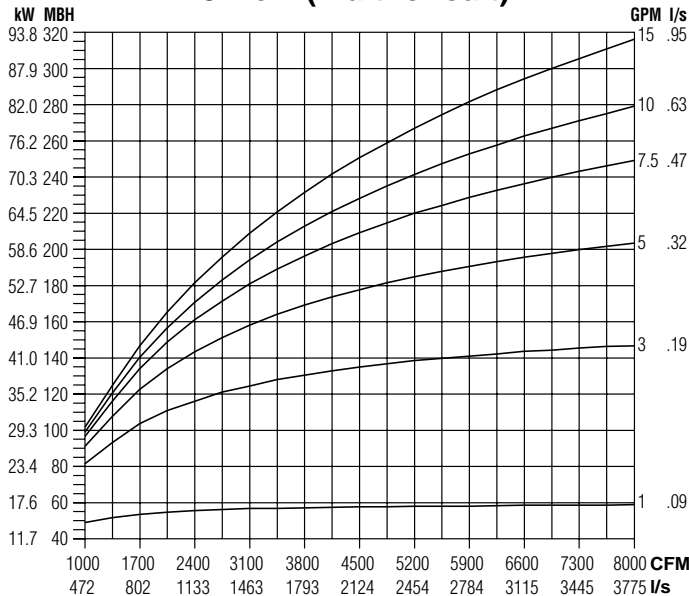

4 Row (multi-circuit)

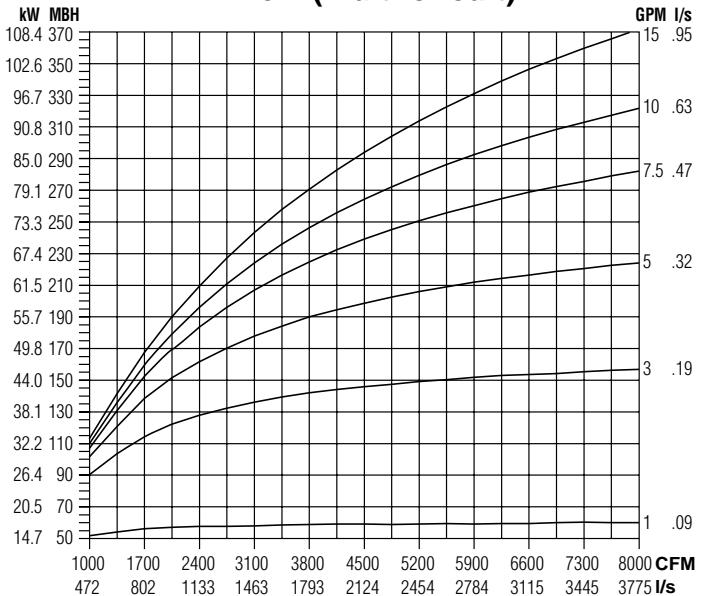

NOTES:

- Capacities are in MBH (kW), *thousands of Btu per hour (kiloWatts)*.
- MBH (kW) values are based on a Δt (temperature difference) of 125°F (69°C) between entering air and entering water. For other Δt 's; multiply the MBH (kW) values by the factors below.

- Air Temperature Rise.

$$\text{ATR (°F)} = 927 \times \frac{\text{MBH}}{\text{cfm}}, \quad \text{ATR (°C)} = 829 \times \frac{\text{kW}}{\text{l/s}}$$

- Water Temp. Drop.

$$\text{WTD (°F)} = 2.04 \times \frac{\text{MBH}}{\text{GPM}}, \quad \text{WTD (°C)} = .224 \times \frac{\text{kW}}{\text{l/s}}$$

- Connections: 1 and 2 Row 7/8" (22). 3 and 4 Row 1 3/8" (35); O.D. male solder.

Altitude Correction Factors:

Altitude ft. (m)	Sensible Heat Factor
0 (0)	1.00
2000 (610)	0.94
3000 (914)	0.90
4000 (1219)	0.87
5000 (1524)	0.84
6000 (1829)	0.81
7000 (2134)	0.78

Correction factors at other entering conditions:

Δt °F (°C)	40 (22)	50 (28)	60 (33)	70 (39)	80 (44)	90 (50)	100 (56)	110 (61)	125 (69)	140 (78)	160 (89)	180 (100)
Factor	.320 (.319)	.400 (.406)	.480 (.478)	.560 (.565)	.640 (.638)	.720 (.725)	.800 (.812)	.880 (.884)	1.00 (1.00)	1.12 (1.13)	1.28 (1.29)	1.44 (1.45)

Performance Data • Hot Water Coil • Pressure Drop

Models: 30RW, 30RWQ and 30HQW

Unit Sizes 4, 5 & 6

Unit Sizes 7 & 8

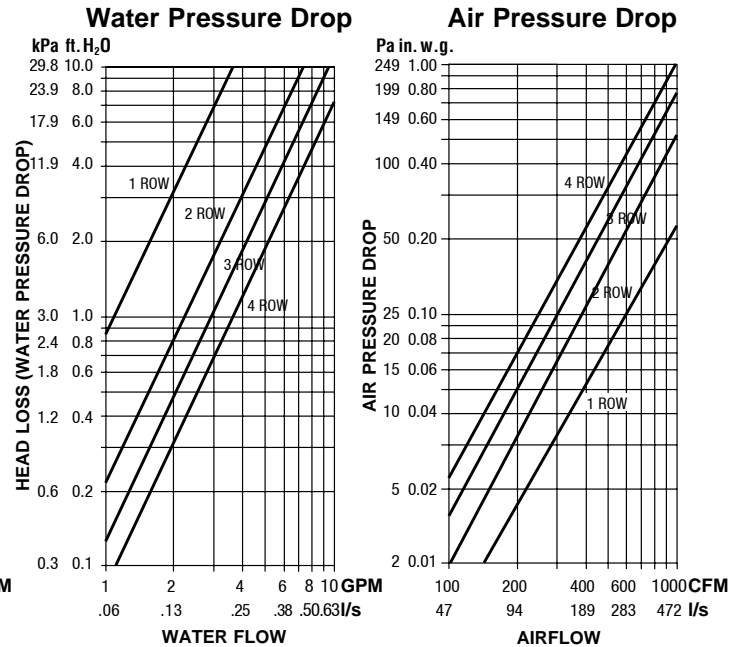
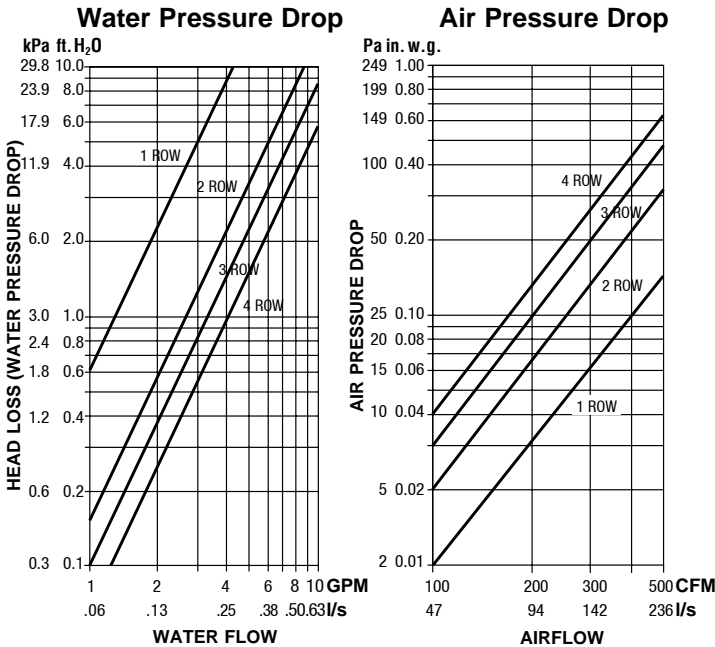

Unit Sizes 9 & 10

Unit Size 12

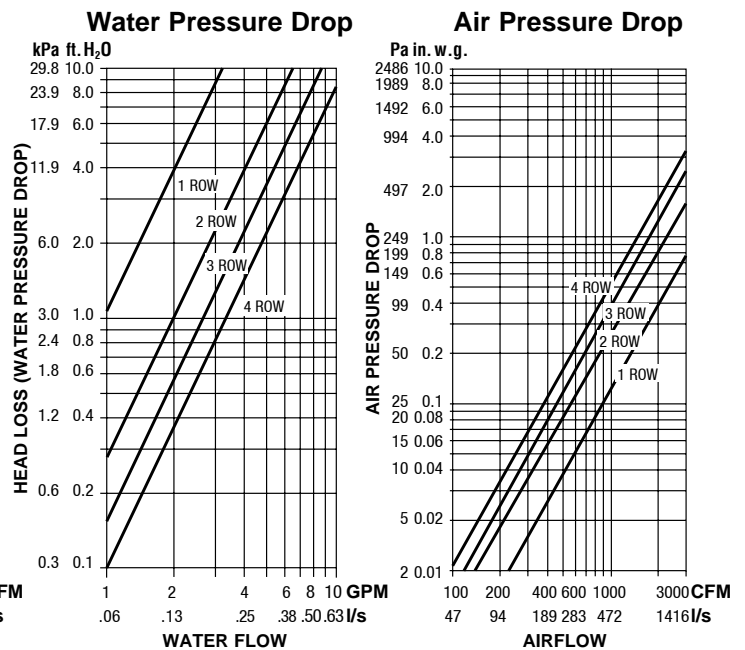
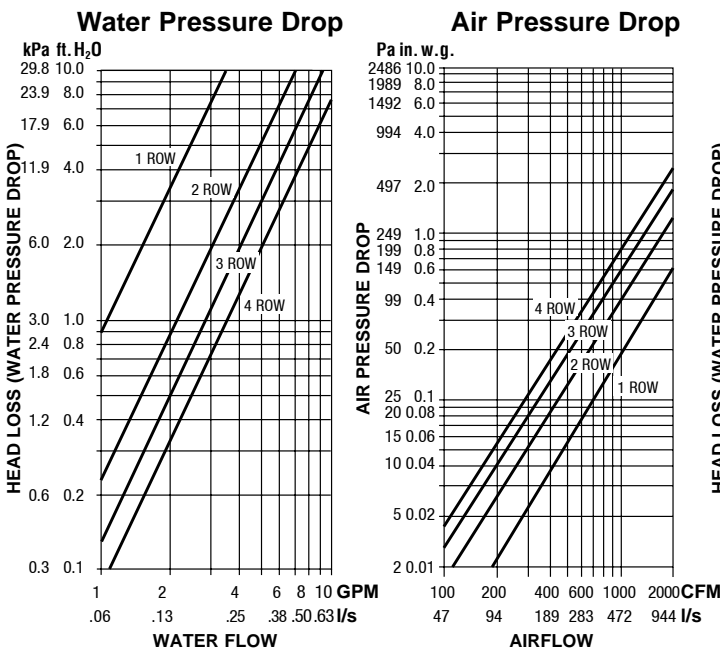

NOTES:

- Capacities are in MBH (kW), **thousands of Btu per hour (kiloWatts)**.
- MBH (kW) values are based on a Δt (temperature difference) of 125°F (69°C) between entering air and entering water. For other Δt 's; multiply the MBH (kW) values by the factors below.
- Air Temperature Rise.
 $ATR (^\circ F) = 927 \times \frac{MBH}{cfm}$, $ATR (^\circ C) = 829 \times \frac{kW}{l/s}$
- Water Temp. Drop.
 $WTD (^\circ F) = 2.04 \times \frac{MBH}{GPM}$, $WTD (^\circ C) = .224 \times \frac{kW}{l/s}$
- Connections: 1 Row 1/2" (13), 2, 3 and 4 Row 7/8" (22); O.D. male solder.

A

SINGLE DUCT TERMINAL UNITS

Performance Data • Hot Water Coil • Pressure Drop

Models: 30RW, 30RWQ and 30HQW

Unit Size 14

Unit Size 16

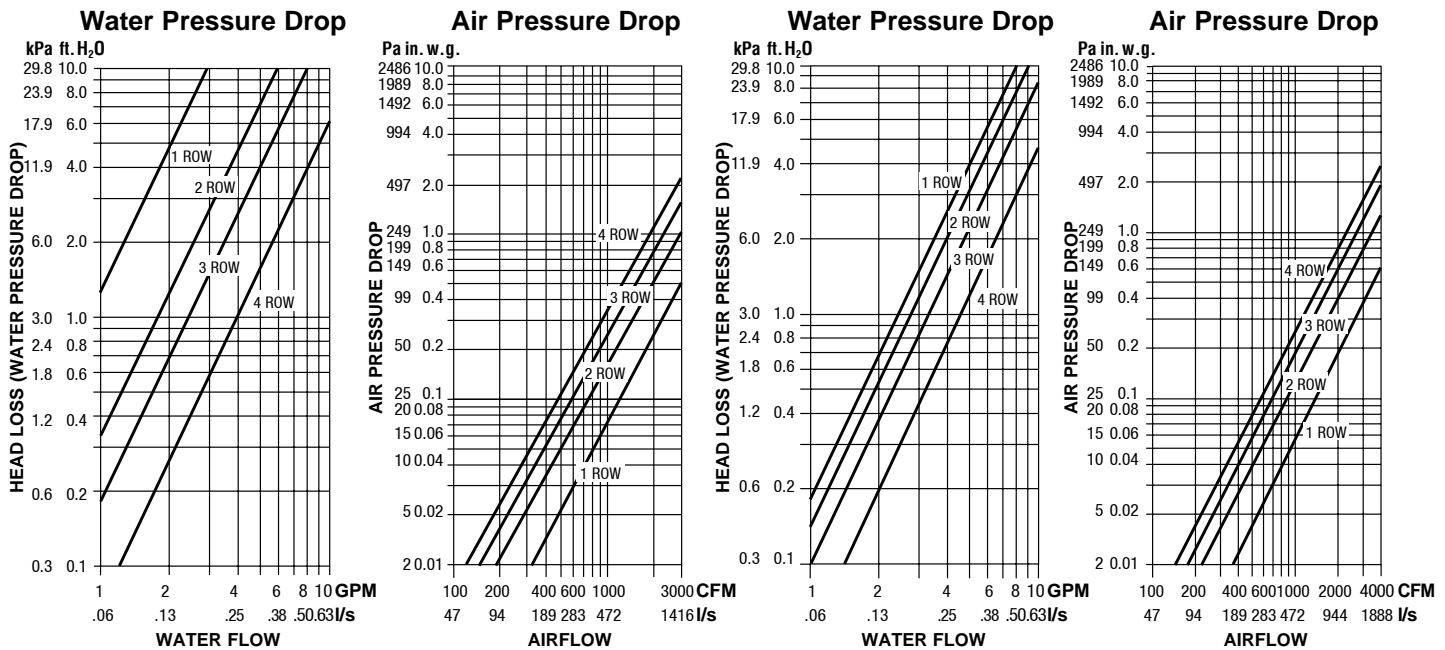

Unit Size 24 x 16

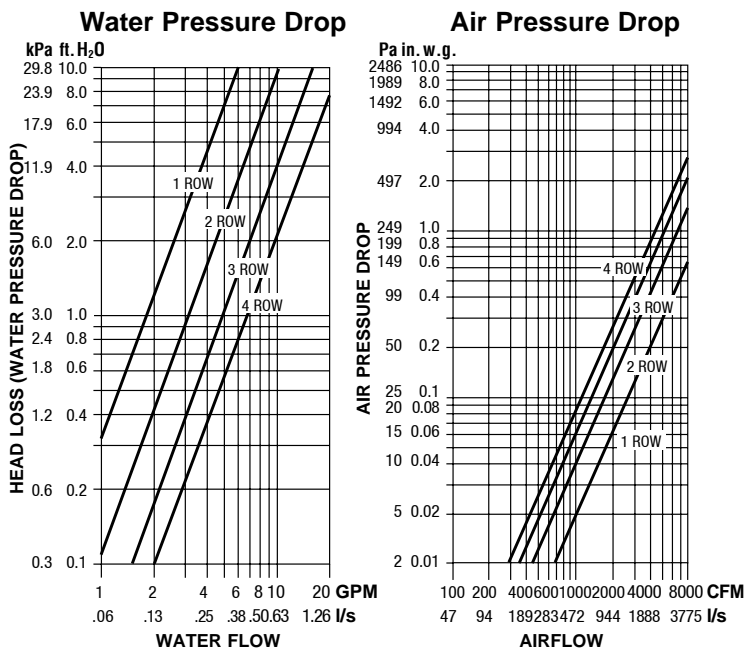

NOTES:

- Capacities are in MBH (kW), **thousands of Btu per hour (kiloWatts)**.
- MBH (kW) values are based on a Δt (temperature difference) of 125°F (69°C) between entering air and entering water. For other Δt 's; multiply the MBH (kW) values by the factors below.
- Air Temperature Rise.

$$\text{ATR (}^\circ\text{F)} = 927 \times \frac{\text{MBH}}{\text{cfm}}, \quad \text{ATR (}^\circ\text{C)} = 829 \times \frac{\text{kW}}{\text{l/s}}$$
- Water Temp. Drop.

$$\text{WTD (}^\circ\text{F)} = 2.04 \times \frac{\text{MBH}}{\text{GPM}}, \quad \text{WTD (}^\circ\text{C)} = .224 \times \frac{\text{kW}}{\text{l/s}}$$
- Connections: 1 Row 1/2" (13), 2, 3 and 4 Row 7/8" (22); O.D. male solder.

Electric Heating Coils Selection, Capacities and Features

Models: 30RE, 30REQ and 30HQE

Nailor manufactures its own electric heating coils. They have been specifically designed and tested for use with variable air volume single duct terminal units.

All terminals with electric heat have been tested and ETL listed as an assembly, eliminating the need to mount coils a minimum of 36" (914) downstream or having to ship a bulky length of ductwork when coils are to be supplied mounted on the terminal.

Nailor electric coils are factory mounted as an integral part of the terminal unit in an insulated extended plenum section. Total length of the casing including heater terminal is only 31" (787), providing a compact, easy to handle unit. The unique inclined opposed blade damper design provides improved and more even airflow over the coil elements compared with round butterfly damper designs, which helps to minimize air stratification, avoid nuisance tripping of the thermal cut-outs and maximize heat transfer.

Selection Guidelines:

The table below provides a general guideline as to the voltages and maximum kiloWatts available for each terminal unit size. Up to three stages of heat are available. A minimum of 0.5 kW/ stage is required.

For optimum diffuser performance and maximum thermal comfort, ASHRAE recommends that discharge temperatures do not exceed 15°F (8°C) above room set point, as stratification and short circuiting may occur. ASHRAE Standard 62.1 limits discharge temperatures to 90°F (32°C) or increasing the



Model 30RE

ventilation rate when heating from the ceiling. Never select kW to exceed a discharge temperatures of 115°F (46°C).

$$\Delta T (\text{Air Temp. Rise, } ^\circ\text{F}) = \frac{\text{kW} \times 3160}{\text{cfm}}$$

The coil ranges listed are restricted to a maximum of 48 amps and do not require circuit fusing to meet NEC code requirements. A minimum of .1" w.g. (25 Pa) of downstream static pressure is required to ensure proper operation of the heater. To avoid possible nuisance tripping of the thermal cutouts due to insufficient airflow, a minimum airflow of 70 cfm (33 l/s) per kilowatt must be maintained.

Electric Coil Limitations

Unit Size	Heating Range* cfm (l/s)	Maximum kW										
		Single Phase						Three Phase				
		120V	208V	220V	240V	277V	347V	208V	380V	480V	600V	
4	25 – 225 (12 – 106)	3.0	3.0	3.0	3.0	3.0	3.0	3.0	3.0	3.0	3.0	3.0
5	45 – 400 (21 – 189)	5.0	5.0	5.0	5.0	5.0	5.0	5.0	5.0	5.0	5.0	5.0
6	65 – 550 (31 – 260)	5.5	7.5	7.5	7.5	7.5	7.5	7.5	7.5	7.5	7.5	7.5
7	95 – 800 (45 – 378)	5.5	9.5	9.5	9.5	9.5	9.5	9.5	9.5	9.5	9.5	9.5
8	125 – 1100 (59 – 519)	5.5	9.5	10.5	11.0	13.0	13.0	13.0	13.0	13.0	13.0	13.0
9	165 – 1400 (78 – 661)	5.5	9.5	10.5	11.0	13.0	16.0	16.0	16.0	16.0	16.0	16.0
10	215 – 1840 (101 – 868)	5.5	9.5	10.5	11.0	13.0	16.5	17.0	16.5	21.0	21.0	
12	290 – 2500 (137 – 1180)	5.5	9.5	10.5	11.0	13.0	16.5	17.0	16.5	30.0	30.0	
14	360 – 3125 (170 – 1475)	5.5	9.5	10.5	11.0	13.0	16.5	17.0	16.5	31.0	38.5	
16	430 – 3725 (203 – 1758)	5.5	9.5	10.5	11.0	13.0	16.5	17.0	16.5	31.0	38.5	
24 x 16	960 – 8330 (453 – 3931)	5.5	9.5	10.5	11.0	13.0	16.5	17.0	16.5	31.0	38.5	

* Minimum required airflow must be the greater of the air volume listed or 70 cfm per kilowatt (33 L/s/kW)

Standard Features:

- Primary auto-reset high limit thermal cut-out.
- Secondary manual reset high limit thermal cut-outs (one per element).
- Positive pressure airflow switch.
- Derated high quality nickel-chrome alloy heating elements.
- Magnetic or safety contactors and/or PE switches as required.
- Control transformer. Class II, 24 Vac for digital and analog controls.
- Line terminal block.
- ETL Listed as an assembly.
- Hinged door control enclosure.
- High performance arrowhead insulators.

- Slip and drive discharge connection.
- Class A 80/20 Ni/Cr wire.

Options:

- Quiet contactors.
- Mercury contactors.
- Toggle type disconnect switch.
- Door interlock disconnect switch.
- Power circuit fusing.
- Dust tight construction.
- SCR control.



Intertek

Tested and approved to the following standards:

ANSI/UL 1996, 4th ed.

CSA C22.2 No. 155-M1986.

A SINGLE DUCT TERMINAL UNITS

30X SERIES • EXHAUST

30HQX SERIES • EXHAUST • HOSPITAL GRADE

QUIET TYPE WITH DISSIPATIVE SILENCER

PRODUCT OVERVIEW

Nailor Single Duct Exhaust Terminal Units are used to modulate exhaust flow from an occupied space in either a constant volume or variable air volume (VAV) HVAC system. These single duct terminal units are ideal for use where zone pressure control is required. Whether selecting the 30X basic unit or the hospital grade 30HQX, each exhaust model is designed and manufactured to provide optimum performance.

The 30X unit is designed to minimize system pressure drop while simultaneously offering quiet operation. To reduce pressure drop, an innovative Venturi is used on the inlet. Further design elements include an optional inlet sound attenuator and a choice of liner types ranging from fiberglass to IAQ types. Designed for hospital applications, the 30HQX provides a premium level of construction and exceptional unit performance. The unique, fully insulated dissipative silencer on the 30HQX has been designed to maximize attenuation in the lower 2nd and 3rd octave bands, which usually dictate room NC levels. As each exhaust unit has been tested as an assembly, you can be assured of predictable performance.

Both exhaust models include a multi-point averaging Diamond Flow sensor for accurate air velocity pressure measurements. This feature allows for a wide variety of control options common to exhaust applications. Other standard features include dual density fiberglass insulation (30X only), slip and drive duct connections and low leakage casing. The 30HQX comes standard with Steri-Liner in the VAV section, a dissipative inlet silencer, special liners, and to facilitate regular cleaning of lint from sensors, a removable flow sensor with access door. The dissipative inlet silencer is constructed with a unique blend of internal baffles, fiberglass insulation wrapped in a mylar barrier, an acoustical separator, and Steri-Liner insulation attached to the top and bottom for thermal protection. All of the insulation choices on the 30X and 30HQX eliminate the need for external field applied thermal duct wrap.

Both models are available with field or factory mounted digital controls. Using the supplied flow sensor and a control device, units can compensate for changes in air pressure, providing a unit that is pressure independent for use in a VAV supply/exhaust tracking application.



30X Basic Unit



30X with Optional Sound Attenuator



30HQX Hospital Grade Unit with Dissipative Silencer

SINGLE DUCT EXHAUST TERMINAL UNITS

30X SERIES

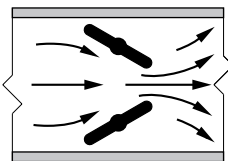

Inclined opposed blade damper configuration minimizes noisy turbulence and provides smooth, accurate, near linear flow control.

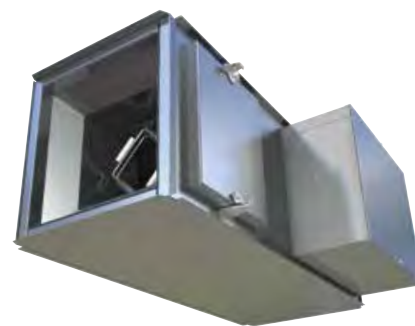

Model 30X

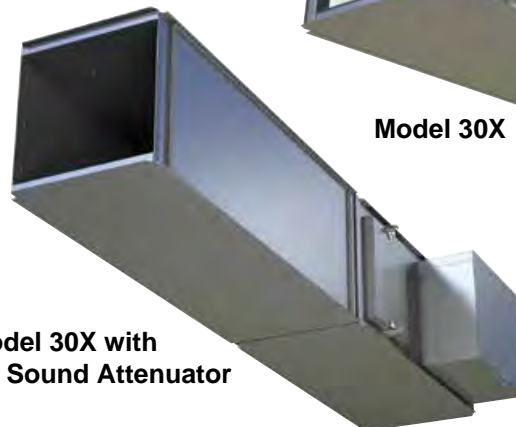

**Model 30X with
Optional Sound Attenuator**

Models:

30X Basic Unit

**30X Basic Unit with
Optional Sound Attenuator**

The 30X Basic Unit has been designed to provide optimum performance in exhaust applications. By including the Optional Sound Attenuator, this terminal unit offers quiet operation with minimal system pressure loss.

STANDARD FEATURES:

- Venturi valve inlet for reduced pressure drop.
- 22 ga. (0.86) zinc coated steel casing, mechanically sealed, low leakage construction.
- 16 ga. (1.63) corrosion-resistant steel inclined opposed blade damper with extruded PVC seals. 45° rotation, CW to close. Tight shut-off. Damper leakage is less than 2% of the terminal rated airflow at 3" w.g. (746 Pa).
- 1/2" (13) dia. plated steel drive shaft. An indicator mark on the end of the shaft shows damper position.
- Multi-point averaging Diamond Flow Sensor. Aluminum construction. Supplied with balancing tees.
- Rectangular inlet and discharge with slip and drive cleat duct connection.
- Full NEMA 1 type controls enclosure for factory mounted controls.
- 3/4" (19), fiberglass dual density insulation, exposed edges coated to prevent air erosion. Meets the requirements of NFPA 90A and UL 181.
- Right-hand controls location is standard (shown) when looking in direction of airflow. Optional left hand controls mounting is available. Unit is flippable.
- Available in 11 unit sizes to handle from 30 – 8575 cfm (14 – 4047 l/s).

Options and Accessories:

- Side access door.
- Removable insert type Diamond Flow sensor.
- Steri-Liner.

- Fiber-Free liner.
- Perforated metal liner.
- Steri-liner + Perforated metal liner.
- Solid metal liner.
- 24 VAC control transformer.
- Toggle disconnect switch.
- Hanger brackets.
- Controls enclosure for field or factory mounted controls.
- Dust tight enclosure seal.
- 20 ga. (1.00) construction.

Optional Sound Attenuator Section:

- Mounted on VAV section inlet for quiet operation.
- Same liner as terminal unit.
- Slip and drive cleat duct connection on both ends.
- 22 ga. (0.86) zinc coated steel casing, mechanically sealed, low leakage construction.
- Optional 20 ga. (1.00) construction.
- IAQ Liners.
- Seismic Certification.



Dimensions

Model 30X • Basic Unit

Digital and Analog Electronic Controls

- A full NEMA 1 controls enclosure is provided for factory mounted controls. Optional for field mounted controls.

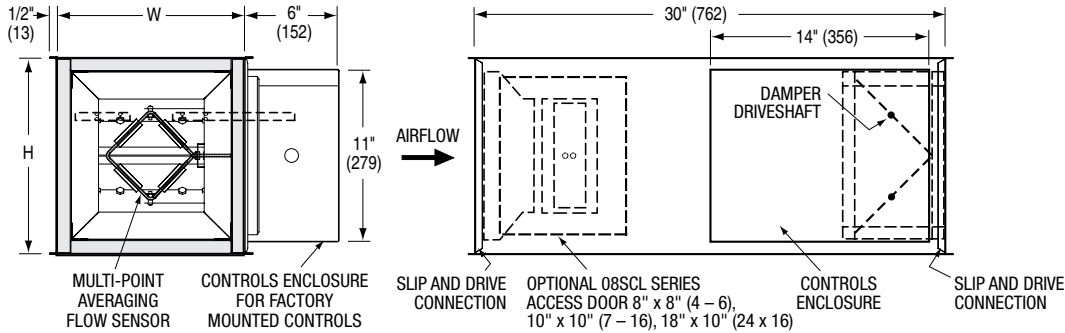

30X • Basic Unit with Optional Sound Attenuator

- A full NEMA 1 controls enclosure is provided for factory mounted controls. Optional for field mounted controls.

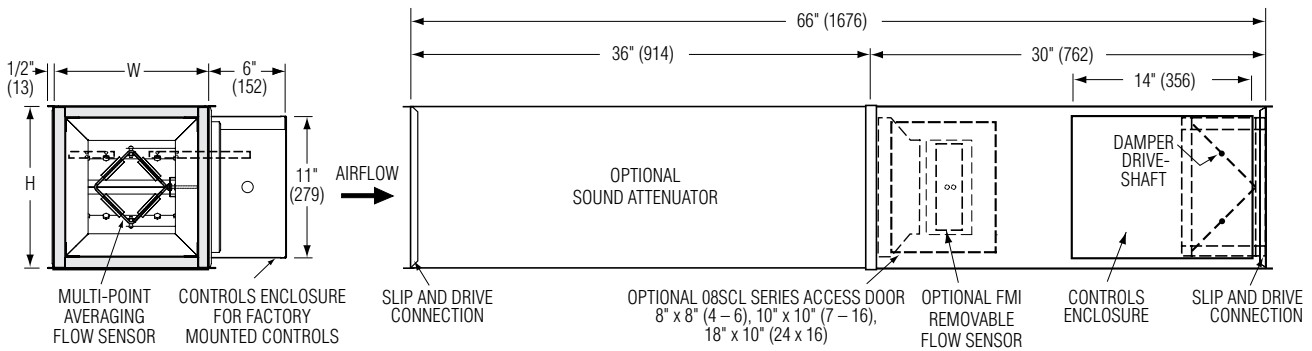

Dimensional Data

Unit Size	W	H
4	10 (254)	10 (254)
5	10 (254)	10 (254)
6	10 (254)	10 (254)
7	12 (305)	12 1/2 (318)
8	12 (305)	12 1/2 (318)
9	14 (356)	12 1/2 (318)
10	14 (356)	12 1/2 (318)
12	18 (457)	12 1/2 (318)
14	24 (610)	12 1/2 (318)
16	28 (711)	12 1/2 (318)
24 x 16	38 (965)	18 (457)

Options and Accessories

Access Door

Premium quality and performance. Square design with camlock operation for positive seal and easy opening.

- Die-formed 22 ga. (0.86) galv. flanged frame for extra strength.
- Die-formed double skin 22 ga. (0.86) galv. door panel for extra strength.
- 1" (25) insulation.
- Notched knock-over tabs.
- Plated steel camlock fasteners.
- Positive seal polyethylene gasket.
- Safety retaining chain.
- Meets SMACNA construction specifications for systems up to 2" w.g. (500 Pa).
- See 0800-1S submittal for more detailed information.

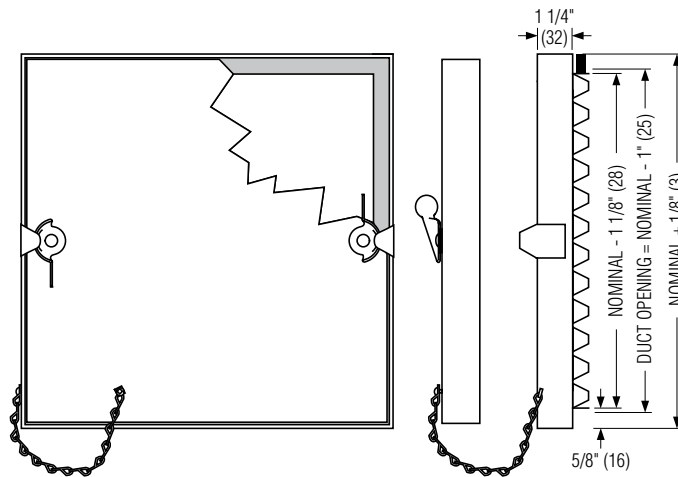

FMI Removable Flow Sensor

The (FMI) Removable Flow Sensor is a multi-point averaging airflow sensor. Designed to provide accurate sensing by sampling air velocities in four quadrants of a duct, the differential pressure

flow sensor provides an averaged reading at an amplification of approximately 2.5 times the velocity pressure, dependent upon nominal size.

FEATURES:

- Removable for cleaning.
- All metal construction - no combustible materials in the air stream.
- Amplifies velocity pressure approximately 2.5 times to give a wide range of useful output signal vs. flow.
- Compact size allows for easy removal in tight spaces.
- Sensor design minimizes pressure drop and regenerated noise.
- Label provided on each unit gives airflow direction.
- Multi-point sensing gives an accurate output signal with a maximum deviation of only $\pm 5\%$ with a hard 90 degree elbow, provided a straight inlet condition with a minimum length of two equivalent duct diameters.

Rectangular Inlet

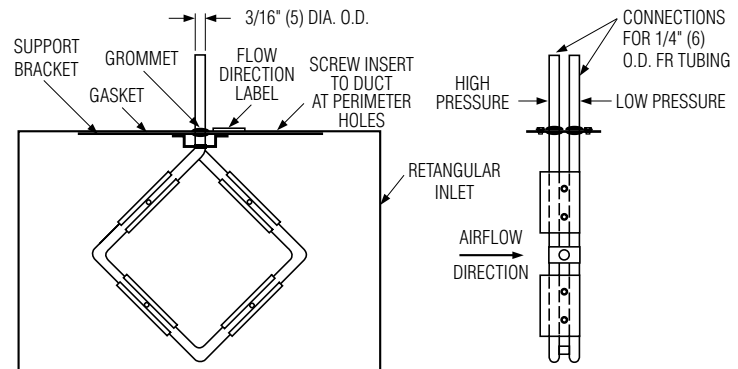

Recommended Airflow Ranges For Model 30X Single Duct Exhaust Terminal Units

The recommended airflow ranges below are for 30X Series exhaust single duct terminal units with pressure independent controls and are presented as ranges for total and controller specific minimum and maximum airflow. Airflow ranges are based upon maintaining reasonable sound levels and controller limits using Nailor's Diamond Flow Sensor as the airflow measuring device. For a given unit size, the minimum, auxiliary minimum (where applicable) and the maximum flow setting must be within the range limits to ensure pressure independent operation, accuracy and repeatability.

Minimum airflow limits are based upon .02" w.g. (5 Pa) differential pressure signal from Diamond Flow Sensor on analog/ digital controls and .03" (7.5) for pneumatic controllers. This is a realistic low limit for many transducers used in the digital controls industry. Check your controls supplier for minimum limits. Setting airflow minimums lower, may cause damper hunting and result in a failure to meet minimum ventilation requirements. Factory settings will therefore not be made outside these ranges; however, a minimum setting of zero (shut-off) is an available option on pneumatic units. Where an auxiliary setting is specified, the value must be greater than the minimum setting.

The high end of the tabulated Total Airflow Range on pneumatic and analog electronic controls represents the Diamond Flow Sensor's differential pressure reading at 1" w.g. (249 Pa). The high end airflow range for digital controls is represented by the indicated transducer differential pressure.

ASHRAE 130 "Performance Rating of Air Terminals" is the method



**Model 30X with
Optional Sound Attenuator**

of test for the certification program. The "standard rating condition" (certification rating point) airflow volumes for each terminal unit size are tabulated below AHRI Standard 880. These air volumes equate to an approximate inlet velocity of 2000 fpm (10.2 m/s).

When digital or other controls are mounted by Nailor, but supplied by others, these values are guidelines only, based upon experience with the majority of controls currently available. Controls supplied by others for factory mounting are configured and calibrated in the field. Airflow settings on pneumatic and analog controls supplied by Nailor are factory preset when provided.

Imperial Units, Cubic Feet per Minute

Unit Size	Inlet Type	Total Airflow Range, cfm	Airflow at 2000 fpm Inlet Velocity (nom.), cfm	Range of Minimum and Maximum Settings, cfm							
				Pneumatic 3000 Controller		Analog Electronic Controls		Digital Controls			
				Transducer Differential Pressure ("w.g.)							
				Min.	Max.	Min.	Max.	Min.	Max.		
				.03	1.0	.02	1.0	.02	1.0	1.25	1.5
4	Rect.	0 – 260	150	35	210	30	210	30	210	235	260
5		0 – 425	250	60	345	50	345	50	345	385	425
6		0 – 710	400	100	580	80	580	80	580	650	710
7		0 – 835	550	120	680	95	680	95	680	760	835
8		0 – 1190	700	170	970	140	970	140	970	1085	1190
9		0 – 1480	900	210	1210	170	1210	170	1210	1350	1480
10		0 – 1885	1100	265	1540	220	1540	220	1540	1720	1885
12		0 – 2780	1600	395	2270	320	2270	320	2270	2540	2780
14		0 – 3085	2100	435	2520	360	2520	360	2520	2820	3085
16		0 – 4385	2800	620	3580	505	3580	505	3580	4000	4385
24 x 16		0 – 8575	5350	1215	7000	990	7000	990	7000	7825	8575

Metric Units, Liters per Second

Unit Size	Inlet Type	Total Airflow Range, l/s	Airflow at 10.2 m/s Inlet Velocity (nom.), l/s	Range of Minimum and Maximum Settings, l/s							
				Pneumatic 3000 Controller		Analog Electronic Controls		Digital Controls			
				Transducer Differential Pressure (Pa)							
				Min.	Max.	Min.	Max.	Min.	Max.		
				7.5	249	5	249	5	249	311	374
4	Rect.	0 – 123	71	17	99	14	99	14	99	111	123
5		0 – 201	118	28	163	24	163	24	163	182	201
6		0 – 335	189	47	274	38	274	38	274	307	335
7		0 – 394	260	57	321	45	321	45	321	359	394
8		0 – 562	330	80	458	66	458	66	458	512	562
9		0 – 698	425	99	571	80	571	80	571	637	698
10		0 – 890	519	125	727	104	727	104	727	812	890
12		0 – 1312	755	186	1071	151	1071	151	1071	1199	1312
14		0 – 1456	991	205	1189	170	1189	170	1189	1331	1456
16		0 – 2069	1321	293	1689	238	1689	238	1689	1888	2069
24 x 16		0 – 4047	2525	573	3303	467	3303	467	3303	3693	4047

Performance Data • NC Level Application Guide

30X Series • Basic Unit

Fiberglass Liner

Inlet Size	Airflow cfm / s		Min. inlet ΔPs "w.g. Pa		NC Levels @ Inlet Pressure (ΔPs) shown											
					DISCHARGE					RADIATED						
					Min. ΔPs	0.5" w.g. (125 Pa)	1.0" w.g. (250 Pa)	1.5" w.g. (375 Pa)	2.0" w.g. (500 Pa)	3.0" w.g. (750 Pa)	Min. ΔPs	0.5" w.g. (125 Pa)	1.0" w.g. (250 Pa)	1.5" w.g. (375 Pa)	2.0" w.g. (500 Pa)	3.0" w.g. (750 Pa)
4	200	94	0.63	157	-	*	-	21	21	23	-	*	-	21	21	20
	150	71	0.37	92	-	-	-	-	-	-	-	-	-	-	-	-
	100	47	0.17	42	-	-	-	-	-	-	-	-	-	-	-	-
	50	24	0.05	12	-	-	-	-	-	-	-	-	-	-	-	-
	30	14	0.02	5	-	-	-	-	-	-	-	-	-	-	-	-
5	300	142	0.55	137	20	*	21	26	28	29	-	*	-	23	25	25
	250	118	0.35	87	-	-	21	24	24	25	-	-	-	20	21	21
	200	94	0.23	57	-	-	-	20	-	21	-	-	-	-	-	-
	125	59	0.10	25	-	-	-	-	-	-	-	-	-	-	-	-
	100	47	0.06	15	-	-	-	-	-	-	-	-	-	-	-	-
6	450	212	0.38	94	-	-	21	26	28	30	-	-	24	28	29	29
	400	189	0.30	75	-	-	21	25	26	28	-	-	23	25	26	26
	300	142	0.18	45	-	-	23	25	26	26	-	-	-	21	20	20
	200	94	0.08	20	-	-	-	-	-	20	-	-	-	-	-	-
	100	47	0.02	5	-	-	-	-	-	-	-	-	-	-	-	-
7	650	307	0.49	122	-	-	21	28	30	34	-	-	21	28	31	34
	550	260	0.35	87	-	-	20	26	29	30	-	-	21	28	30	31
	335	158	0.13	32	-	-	-	20	20	20	-	-	-	20	20	20
	225	106	0.06	15	-	-	-	-	-	-	-	-	-	-	-	-
	110	52	0.02	5	-	-	-	-	-	-	-	-	-	-	-	-
8	800	378	0.35	87	-	-	23	29	31	34	-	21	26	30	33	35
	700	330	0.27	67	-	-	21	26	30	31	-	-	25	29	31	33
	600	283	0.20	50	-	-	24	28	30	31	-	-	24	28	29	29
	400	189	0.09	22	-	-	-	21	23	24	-	-	-	20	20	20
	175	83	0.02	5	-	-	-	-	-	-	-	-	-	-	-	-
9	1050	495	0.37	92	-	-	21	28	30	34	21	21	26	30	33	35
	900	425	0.27	67	-	-	20	26	28	30	-	-	24	28	30	33
	675	319	0.15	37	-	-	20	24	25	28	-	-	20	24	26	28
	450	212	0.07	17	-	-	-	20	20	20	-	-	-	-	-	20
	225	106	0.02	5	-	-	-	-	-	-	-	-	-	-	-	-
10	1350	637	0.38	94	-	-	24	30	34	38	-	-	26	31	35	39
	1100	519	0.25	62	-	-	24	29	30	34	-	-	26	30	33	36
	825	389	0.15	37	-	-	20	24	26	28	-	-	21	26	28	29
	550	260	0.07	17	-	-	-	20	21	23	-	-	-	-	20	24
	275	130	0.02	5	-	-	-	-	-	-	-	-	-	-	-	-
12	2000	944	0.37	92	-	-	24	31	35	36	23	23	34	34	36	40
	1600	755	0.24	60	-	-	24	28	30	33	-	-	28	31	34	35
	1200	566	0.14	35	-	-	20	24	26	29	-	-	24	26	28	30
	800	378	0.06	15	-	-	-	20	21	23	-	-	-	20	20	23
	400	189	0.02	5	-	-	-	-	-	-	-	-	-	-	-	-
14	2700	1274	0.54	134	21	*	31	35	35	41	29	*	31	34	36	39
	2100	991	0.33	82	-	21	28	34	33	34	21	21	28	31	33	35
	1550	731	0.18	45	-	-	23	25	28	28	-	-	23	25	25	28
	1050	495	0.08	20	-	-	-	-	-	21	-	-	-	-	20	21
	525	248	0.02	5	-	-	-	-	-	20	-	-	-	-	-	-
16	3500	1652	0.48	119	20	21	31	35	35	39	30	30	31	35	38	41
	2800	1321	0.31	77	-	21	26	29	33	35	21	23	29	33	34	36
	2100	991	0.18	45	-	-	23	25	28	30	-	-	23	26	29	31
	1400	661	0.08	20	-	-	-	20	20	23	-	-	-	20	21	23
	700	330	0.02	5	-	-	-	-	-	20	-	-	-	-	-	-
24 x 16	5350	2525	0.45	112	31	33	35	38	41	45	40	40	36	38	40	43
	5000	2360	0.39	97	28	29	31	35	39	41	43	39	35	36	39	41
	4000	1888	0.25	62	21	23	28	33	35	38	30	30	31	34	35	36
	3000	1416	0.14	35	-	-	25	30	31	34	20	21	25	30	31	33
2000	944	0.06	15	-	-	23	26	29	31	-	-	21	24	26	29	

Performance Notes:

1. NC Levels are calculated based on procedures as outlined on page A101.
2. Dash (-) in space indicates a NC less than 20.
3. Asterisk (*) in space indicates that the minimum inlet static pressure requirement is greater than 0.5" w.g. (125 Pa) at rated airflow.

A

SINGLE DUCT TERMINAL UNITS

Performance Data • Discharge Sound Power Levels
30X Series • Basic Unit
Fiberglass Liner

Inlet Size	Airflow		Min. inlet ΔPs		Sound Power Octave Bands @ Inlet Pressure (ΔPs) shown																																									
					Minimum ΔPs							0.5" w.g. (125Pa) ΔPs							1.0" w.g. (250Pa) ΔPs							1.5" w.g. (375Pa) ΔPs							2.0" w.g. (500Pa) ΔPs							3.0" w.g. (750Pa) ΔPs						
					2	3	4	5	6	7	2	3	4	5	6	7	2	3	4	5	6	7	2	3	4	5	6	7	2	3	4	5	6	7	2	3	4	5	6	7						
4	200	94	0.63	157	59	59	54	50	51	47	*	*	*	*	*	*	62	60	54	51	51	47	65	61	55	53	51	48	65	62	56	54	51	48	65	63	57	57	52	49						
	150	71	0.37	92	55	54	48	43	43	39	55	54	48	44	43	39	61	56	49	47	44	39	60	57	50	50	44	41	60	58	51	52	45	42	60	57	52	54	46	45						
	100	47	0.17	42	-	45	41	33	31	25	-	47	41	37	32	25	-	51	44	43	34	31	-	51	45	46	37	36	-	51	45	47	38	38	-	51	45	48	41	42						
	50	24	0.05	12	-	-	-	-	-	-	-	40	29	29	20	21	-	40	32	34	27	26	-	41	33	35	32	33	-	42	33	36	35	36	-	41	33	35	37	40						
	30	14	0.02	5	-	-	-	-	-	-	-	22	25	-	-	-	-	24	28	25	26	-	-	26	28	28	30	-	-	26	29	30	32	-	-	26	29	31	33	36						
5	300	142	0.55	137	60	61	59	54	52	50	*	*	*	*	*	*	65	62	59	55	52	50	69	64	59	56	53	50	70	66	60	57	53	51	71	67	61	59	54	52						
	250	118	0.35	87	56	58	54	49	45	41	58	58	54	49	45	41	65	59	54	50	46	42	67	62	55	52	47	43	67	63	57	54	47	44	68	63	57	56	49	47						
	200	94	0.23	57	-	54	49	43	39	33	58	55	50	44	40	35	63	57	51	47	40	37	64	59	52	49	42	39	63	60	53	51	43	41	65	60	54	54	46	46						
	125	59	0.10	25	-	44	39	30	23	-	-	48	40	36	26	21	56	52	44	41	32	30	57	54	46	45	37	36	57	54	47	47	39	39	57	54	48	49	44	46						
	100	47	0.06	15	-	40	34	24	-	-	-	46	37	33	23	20	-	50	42	39	31	30	56	51	43	43	36	36	-	51	44	45	39	39	55	51	45	46	43	45						
6	450	212	0.38	94	58	56	55	49	52	45	61	56	55	49	52	45	68	59	56	51	52	47	72	64	57	53	53	48	73	67	59	54	53	49	75	70	62	57	55	52						
	400	189	0.30	75	-	51	47	39	40	30	60	55	53	47	47	41	68	58	53	49	47	43	71	64	56	51	48	45	72	66	58	53	49	47	73	68	61	56	52	50						
	300	142	0.18	45	-	51	47	39	40	30	58	52	47	41	41	32	66	58	49	45	41	37	68	62	53	48	44	41	69	63	56	50	46	44	69	65	58	54	49	48						
	200	94	0.08	20	-	42	38	26	22	-	57	48	41	35	29	24	62	56	46	41	35	34	62	58	50	45	39	40	62	59	52	48	42	43	64	58	53	52	45	47						
	100	47	0.02	5	-	-	-	-	-	-	-	45	34	32	27	22	55	49	41	37	32	34	54	47	41	40	38	37	-	46	41	42	41	41	56	48	43	43	43	46						
7	650	307	0.49	122	64	59	54	54	52	52	63	57	52	50	50	50	68	61	55	54	52	53	73	64	57	56	53	53	75	66	58	57	54	54	78	69	61	59	56	56						
	550	260	0.35	87	61	55	50	49	47	45	62	56	50	48	47	45	67	60	53	51	49	48	72	62	54	54	50	49	74	64	56	55	52	50	75	68	59	57	54	53						
	335	158	0.13	32	59	45	39	36	32	27	59	50	42	40	35	33	65	55	46	44	39	38	67	59	49	47	43	42	67	60	51	49	45	45	67	61	54	53	48	49						
	225	106	0.06	15	51	38	30	23	-	-	57	46	37	34	28	28	60	52	42	40	35	35	63	55	46	44	40	41	61	55	48	46	43	44	62	55	49	49	46	49						
	110	52	0.02	5	-	-	-	-	-	-	52	42	31	29	25	24	53	44	37	38	36	34	56	44	38	40	41	41	54	45	38	40	43	44	57	49	41	42	45	48						
8	800	378	0.35	87	61	54	50	49	51	48	66	57	51	50	51	48	71	61	54	52	52	51	76	65	57	54	54	52	78	67	58	55	55	53	80	71	61	57	57	56						
	700	330	0.27	67	56	52	48	46	47	42	67	56	50	48	48	43	70	59	52	50	50	48	74	63	55	52	51	50	77	66	57	54	53	52	78	69	61	56	55	55						
	600	283	0.20	50	55	49	45	42	42	37	64	54	48	46	45	39	70	58	50	49	46	44	73	62	54	52	49	48	75	65	56	53	51	50	76	67	59	55	54	53						
	400	189	0.09	22	-	43	38	32	26	20	61	49	42	40	34	31	66	55	48	46	41	40	68	59	51	48	45	44	69	60	54	51	48	46	70	62	59	54	51	51						
	175	83	0.02	5	-	-	22	-	-	-	57	45	35	31	27	26	58	48	41	39	36	35	57	47	45	45	44	43	57	48	44	46	46	46	58	48	45	50	50	51						
9	1050	495	0.37	92	60	58	56	55	54	52	63	59	56	55	53	52	70	62	57	56	55	53	75	65	59	58	56	54	77	68	60	59	56	55	80	71	63	61	59	58						
	900	425	0.27	67	56	55	53	51	48	45	62	58	54	52	49	46	69	61	55	53	50	47	74	64	57	55	52	49	75	67	59	57	54	52	77	70	62	59	58	56						
	675	319	0.15	37	-	52	50	43	38	33	60	55	50	44	39	35	67	59	52	48	44	41	70	62	55	52	48	46	71	64	56	53	51	49	73	66	59	56	54	53						
	450	212	0.07	17	-	47	42	30	21	-	58	51	44	38	33	32	64	55	47	43	40	38	66	58	50	46	44	43	67	59	52	49	47	46	67	61	54	52	49	50						
	225	106	0.02	5	-	-	-	-	-	-	-	43	33	31	28	26	57	48	40	39	37	36	61	49	42	43	43	42	58	50	43	44	46	45	61	51	45	46	48	50						
10	1350	637	0.38	94	63	54	51	52	56	51	68	60	54	54	56	52	72	64	58	55	57	53	77	67	60	57	57	55	80	70	62	59	58	57	83	73	66	62	61	60						
	1100	519	0.25	62	59	50	47	47	49	41	65	56	50	49	50	44	72	62	55	52	51	48	76	65	58	54	53	51	77	67	61	56	55	54	80	71	64	60	59	58						
	825	389	0.15	37	-	43	40	39	37	29	64	56	49	46	43	40	69	59	52	48	46	44	72	63	56	52	50	48	74	65	58	54	52	50	75	68	61	55	55	54						
	550	260	0.07	17	-	38	31	26	-	-	58	50	43	38	35	35	64	56	48	43	41	39	67	59	51	45	44	43	68	61	54	48	47	46	69	62	57	51	49	51						
	275	130	0.02	5	-	37	22	-	-	-	-	44	35	30	28	27	60	49	42	37	37	35	61	51	45	42	42	42	58	51	46	44	45	46	62	53	48	47	49	50						
12	2000	944	0.37	92	63	56	53	55	58	51	68	59	55	55	59	52	72	64	59	58	59	55	78	68	62	60	59	57	81	70	64	62	61	59	83	73	68	64	63	62						
	1600	755	0.24	60	58	51	49	49	51	42	66	57	52	52	52	45	72	62	57	55	54	51	75	66	60	58	56	54	77	68	62	59	58	56	79	71	65	62	61	59						
	1200	566	0.14	35	-	43	42	41	37	30	63	54	48	46	43	40	69	60	54	52	49	48	72	63	57	54	52	51	74	66	59	56	54	53	76	68	63	59	57	56						
	800	378	0.06	15	-	-	33	28	20	-	60	49	44	41	38	37	66	57	50	47	44	43	69	60	54	49	47	47	70	62	56	52	50	49	71	63	59	55	53	53						
	400	189	0.02	5	-	-	-	-	-	-	-	44	38	34	31	31	59	49	43	41	39	38	63	51	47	45	45	44	61	52	50															

Performance Data • Radiated Sound Power Levels

30X Series • Basic Unit

Fiberglass Liner

Inlet Size	Airflow		Min. inlet ΔPs		Sound Power Octave Bands @ Inlet Pressure (ΔPs) shown																																									
					Minimum ΔPs							0.5" w.g. (125Pa) ΔPs							1.0" w.g. (250Pa) ΔPs							1.5" w.g. (375Pa) ΔPs							2.0" w.g. (500Pa) ΔPs							3.0" w.g. (750Pa) ΔPs						
					2	3	4	5	6	7	2	3	4	5	6	7	2	3	4	5	6	7	2	3	4	5	6	7	2	3	4	5	6	7	2	3	4	5	6	7						
4	200	94	0.63	157	52	42	33	27	27	21	*	*	*	*	*	*	55	43	34	28	27	22	59	49	39	33	28	23	59	50	41	36	29	25	58	50	44	39	32	28						
	150	71	0.37	92	48	35	27	-	-	-	49	36	27	-	-	-	54	43	33	27	21	-	54	45	37	31	23	20	54	45	39	33	26	22	52	44	40	36	29	26						
	100	47	0.17	42	-	-	-	-	-	-	47	35	24	-	-	-	47	38	30	24	-	-	49	39	33	28	-	-	49	38	33	29	23	21	48	38	34	32	29	26						
	50	24	0.05	12	-	-	-	-	-	-	-	-	-	-	-	-	-	-	-	-	-	-	-	-	24	23	-	-	-	31	26	25	23	-	47	36	31	30	28	25						
	30	14	0.02	5	-	-	-	-	-	-	-	-	-	-	-	-	-	-	-	-	-	-	-	-	24	23	-	-	-	32	26	25	24	-	-	35	31	30	28	26						
5	300	142	0.55	137	51	42	35	27	25	-	*	*	*	*	*	*	55	45	37	31	26	21	60	50	40	35	29	23	62	52	42	37	32	26	62	53	47	41	37	31						
	250	118	0.35	87	-	39	31	23	-	-	-	39	32	26	-	-	55	44	35	30	22	-	58	49	39	34	27	21	59	50	42	36	30	24	59	51	45	40	35	30						
	200	94	0.23	57	-	-	-	-	-	-	-	37	29	21	-	-	53	44	34	29	-	-	55	46	38	33	25	-	54	47	40	35	29	24	53	47	42	38	33	29						
	125	59	0.10	25	-	-	-	-	-	-	-	-	-	-	-	-	-	39	33	27	-	-	-	40	35	30	23	-	-	39	36	31	27	23	-	40	36	34	32	29						
	100	47	0.06	15	-	-	-	-	-	-	-	-	-	-	-	-	-	36	30	24	-	-	-	36	32	27	23	-	-	35	32	29	27	23	-	37	33	32	32	28						
6	450	212	0.38	94	53	43	35	28	25	-	54	44	35	28	25	-	61	49	39	31	28	22	64	54	42	35	30	24	65	57	46	38	33	27	65	58	51	42	37	31						
	400	189	0.30	75	51	40	33	24	-	-	54	42	33	26	21	-	60	47	36	30	24	-	62	52	41	34	28	22	63	55	44	36	31	25	63	57	49	41	35	30						
	300	142	0.18	45	-	34	25	20	20	-	51	38	29	22	-	-	56	46	35	28	21	-	59	50	40	33	26	-	58	51	42	35	29	22	58	51	46	40	34	28						
	200	94	0.08	20	-	-	-	-	-	-	49	36	27	21	-	-	52	44	34	27	-	-	53	46	39	31	24	-	51	47	40	33	27	22	50	46	42	37	31	26						
	100	47	0.02	5	-	-	-	-	-	-	-	34	23	-	-	-	-	28	23	-	-	-	-	36	30	26	21	-	-	34	32	28	24	21	-	37	33	31	28	26						
7	650	307	0.49	122	56	50	42	33	27	25	56	50	42	33	27	25	59	52	42	35	30	27	64	54	46	41	34	29	67	56	47	44	36	31	69	59	50	47	39	34						
	550	260	0.35	87	53	46	38	28	24	-	54	43	34	26	25	-	59	49	41	35	29	23	64	52	44	40	32	27	66	54	45	42	34	29	67	57	48	45	37	32						
	335	158	0.13	32	-	-	-	-	-	-	-	37	31	26	-	-	55	44	35	31	22	20	58	48	38	34	27	21	58	49	40	35	29	25	58	50	43	38	33	30						
	225	106	0.06	15	-	-	-	-	-	-	-	26	21	-	-	-	51	41	32	26	-	-	51	44	36	30	25	21	52	43	37	32	28	25	50	43	39	36	32	31						
	110	52	0.02	5	-	-	-	-	-	-	-	-	-	-	-	-	-	25	23	-	-	-	-	28	27	25	22	-	30	28	28	25	-	39	34	33	31	30								
8	800	378	0.35	87	57	47	41	32	26	20	59	48	40	31	26	21	63	53	45	37	31	27	66	55	45	38	33	29	68	57	47	39	35	31	70	60	50	42	38	36						
	700	330	0.27	67	53	44	38	29	22	-	57	46	37	28	23	-	62	50	41	34	29	25	65	53	43	36	32	27	67	56	45	38	33	29	68	58	49	41	37	34						
	600	283	0.20	50	50	40	34	26	-	-	54	43	35	27	-	-	61	48	39	32	26	21	64	52	42	35	30	26	65	55	44	37	32	28	65	57	48	40	36	33						
	400	189	0.09	22	51	38	30	22	-	-	50	38	31	25	-	-	56	45	36	30	22	-	58	49	39	33	27	22	58	50	42	35	30	25	58	51	44	38	34	31						
	175	83	0.02	5	-	-	-	-	-	-	50	40	30	25	-	-	-	36	31	27	23	-	-	37	33	30	26	23	-	38	34	31	30	27	49	42	36	34	33	31						
9	1050	495	0.37	92	59	50	44	34	30	28	59	49	43	34	31	28	63	53	45	36	32	28	66	56	49	41	36	32	68	58	52	44	36	32	70	61	56	48	40	35						
	900	425	0.27	67	54	46	40	30	25	21	57	47	39	31	26	21	61	51	44	35	29	22	64	54	48	40	32	26	66	56	51	43	35	29	68	60	54	47	40	34						
	675	319	0.15	37	-	40	33	23	-	-	54	44	36	28	21	-	58	49	42	34	26	-	61	52	47	39	31	24	63	54	49	42	34	28	64	56	52	45	37	32						
	450	212	0.07	17	-	-	-	-	-	-	52	39	33	26	-	-	54	45	41	33	24	-	56	48	43	36	28	22	57	50	44	38	30	25	57	51	46	41	34	30						
	225	106	0.02	5	-	-	-	-	-	-	-	-	-	-	-	-	50	38	31	27	-	-	51	39	34	31	25	21	50	40	36	33	28	24	50	42	39	36	31	29						
10	1350	637	0.38	94	56	48	40	34	32	25	56	49	40	33	32	25	63	53	43	37	34	27	67	56	46	39	35	30	70	59	48	41	37	31	73	63	53	45	40	35						
	1100	519	0.25	62	52	43	34	28	23	-	56	46	37	31	25	-	63	50	40	34	29	22	66	55	44	37	32	26	68	57	47	39	35	29	71	61	51	44	39	34						
	825	389	0.15	37	-	39	29	-	-	-	53	42	33	27	-	-	59	48	38	32	25	-	63	53	43	36	30	24	64	55	45	38	33	27	65	58	49	41	36	32						
	550	260	0.07	17	-	-	-	-	-	-	50	39	30	23	-	-	56	46	37	30	23	-	57	49	40	32	27	23	58	51	42	34	29	25	60	55	47	40	35	32						
	275	130	0.02	5	-	-	-	-	-	-	-	-	-	-	-	-	20	39	30	23	-	-	54	42	33	27	23	23	49	43	35	30	26	25	54	46	38	33	31	30						
12	2000	944	0.37	92	60	50	44	35	34	29	60	49	44	35	34	29	69	58	50	41	38	34	69	59	52	45	43	40	71	60	51	43	39	36	74	64	55	47	43	40						
	1600	755	0.24	60	54	47	42	37	39	33	57	50	45	41	46	40	64	53	46	41	43	38	67	57	48	41	40	35	69	59	50	42	38	35	70	62	53	45	42	39						
	1200	566	0.14	35	48	37	31	21	-	-	55	45	36	29	27	24	61	50	42	34	30	27	63	54	45	37	33	31	64	56	47	39	35	33	66	59	51	43	40	38						
	800	378	0.06	15	-	-	-	-	-	-	51	41	32	24	-	-	56	47	38	30	25	22	58	50	42	34	31	29	58	52	44	36	33	32	60	54	47	40	38	38						
	400	189	0.02	5	-	-	-	-	-	-	-	35	26	-	-	-	49	39	32	27	26	25	52	41	35	31	32	31	50	42	35	33	34	35	52	44	38	36	38	39						
14	2700	1274	0.54	134	65	57	53	42	35	31	*	*	*	*	*	*	67	58	50	41	35	32	69	60	51	43	37	34	71	62	52	44	39	35	73	65	55	48	42	38						
	2100	991</																																												

Performance Data • NC Level Application Guide

30X Series • Optional Attenuator

Fiberglass Liner

Inlet Size	Airflow cfm /s		Min. inlet ΔPs "w.g. Pa		NC Levels @ Inlet Pressure (ΔPs) shown											
					DISCHARGE w/36" (914) attenuator					RADIATED w/36" (914) attenuator						
					Min. ΔPs	0.5" w.g. (125 Pa)	1.0" w.g. (250 Pa)	1.5" w.g. (375 Pa)	2.0" w.g. (500 Pa)	3.0" w.g. (750 Pa)	Min. ΔPs	0.5" w.g. (125 Pa)	1.0" w.g. (250 Pa)	1.5" w.g. (375 Pa)	2.0" w.g. (500 Pa)	3.0" w.g. (750 Pa)
4	200	94	0.63	159	-	*	-	-	-	-	-	*	-	21	21	20
	150	71	0.37	92	-	-	-	-	-	-	-	-	-	-	-	-
	100	47	0.17	43	-	-	-	-	-	-	-	-	-	-	-	-
	50	24	0.05	12	-	-	-	-	-	-	-	-	-	-	-	-
	30	14	0.02	5	-	-	-	-	-	-	-	-	-	-	-	-
5	300	142	0.55	136	-	*	-	-	-	-	-	*	-	23	25	25
	250	118	0.35	87	-	-	-	-	-	-	-	-	-	20	21	21
	200	94	0.23	57	-	-	-	-	-	-	-	-	-	-	-	-
	125	59	0.10	25	-	-	-	-	-	-	-	-	-	-	-	-
	100	47	0.06	15	-	-	-	-	-	-	-	-	-	-	-	-
6	450	212	0.38	94	-	-	-	-	20	21	-	-	24	28	29	29
	400	189	0.30	75	-	-	-	-	-	20	-	-	23	25	26	26
	300	142	0.18	44	-	-	-	-	-	-	-	-	-	21	20	20
	200	94	0.08	21	-	-	-	-	-	-	-	-	-	-	-	-
	100	47	0.02	6	-	-	-	-	-	-	-	-	-	-	-	-
7	650	307	0.50	125	-	-	-	-	23	25	-	-	21	28	31	34
	550	259	0.35	88	-	-	-	-	20	23	-	-	21	28	30	31
	335	158	0.13	34	-	-	-	-	-	-	-	-	20	20	20	20
	225	106	0.06	16	-	-	-	-	-	-	-	-	-	-	-	-
	110	52	0.02	4	-	-	-	-	-	-	-	-	-	-	-	-
8	800	377	0.35	87	-	-	-	20	23	25	-	21	26	30	33	35
	700	330	0.27	68	-	-	-	-	20	23	-	-	25	29	31	33
	600	283	0.20	51	-	-	-	-	20	21	-	-	24	28	29	29
	400	189	0.09	24	-	-	-	-	-	-	-	-	-	20	20	20
	175	83	0.02	5	-	-	-	-	-	-	-	-	-	-	-	-
9	1050	495	0.39	98	-	-	-	-	21	25	21	21	26	30	33	35
	900	425	0.29	73	-	-	-	-	20	24	-	-	24	28	30	33
	675	318	0.16	40	-	-	-	-	-	20	-	-	20	24	26	28
	450	212	0.07	17	-	-	-	-	-	-	-	-	-	-	-	20
	225	106	0.02	4	-	-	-	-	-	-	-	-	-	-	-	-
10	1350	637	0.44	110	-	-	-	23	25	29	-	-	26	31	35	39
	1100	519	0.29	73	-	-	-	20	23	25	-	-	26	30	33	36
	825	389	0.16	40	-	-	-	-	-	20	-	-	21	26	28	29
	550	259	0.07	17	-	-	-	-	-	-	-	-	-	-	20	24
	275	130	0.02	4	-	-	-	-	-	-	-	-	-	-	-	-
12	2000	943	0.41	103	-	-	-	24	26	30	23	23	34	34	36	40
	1600	755	0.27	68	-	-	-	20	23	28	-	-	28	31	34	35
	1200	566	0.15	38	-	-	-	-	20	28	-	-	24	26	28	30
	800	377	0.07	17	-	-	-	-	-	-	-	-	-	20	20	23
	400	189	0.02	4	-	-	-	-	-	-	-	-	-	-	-	-
14	2700	1274	0.58	145	-	*	23	28	29	33	29	*	31	34	36	39
	2100	991	0.34	85	-	-	21	25	25	28	21	21	28	31	33	35
	1550	731	0.18	46	-	-	-	-	-	21	-	-	23	25	25	28
	1050	495	0.09	22	-	-	-	-	-	-	-	-	-	-	20	21
	525	248	0.02	6	-	-	-	-	-	-	-	-	-	-	-	-
16	3500	1651	0.48	119	-	-	23	26	29	33	30	30	31	35	38	41
	2800	1321	0.31	77	-	-	20	24	26	30	21	23	29	33	34	36
	2100	991	0.18	44	-	-	-	21	21	25	-	-	23	26	29	31
	1400	660	0.08	20	-	-	-	-	-	-	-	-	-	20	21	23
	700	330	0.02	5	-	-	-	-	-	-	-	-	-	-	-	-
24	5350	2524	0.47	118	26	26	29	34	35	40	40	40	36	38	40	43
	5000	2358	0.40	100	25	25	28	33	34	39	39	39	35	36	39	41
16	4000	1887	0.26	65	-	20	25	30	34	36	30	30	31	34	35	36
	3000	1415	0.15	38	-	-	23	29	30	33	20	21	25	30	31	33
16	2000	943	0.07	18	-	-	21	24	26	29	-	-	21	24	26	29

Performance Notes:

1. NC Levels are calculated based on procedures as outlined on page A101.
2. Dash (-) in space indicates a NC less than 20.
3. Asterisk (*) in space indicates that the minimum inlet static pressure requirement is greater than 0.5" w.g. (125 Pa) at rated airflow.

Performance Data • Discharge Sound Power Levels
30X Series • Optional Attenuator
Fiberglass Liner

SINGLE DUCT TERMINAL UNITS

Inlet Size	Airflow		Min. inlet ΔPs		Sound Power Octave Bands @ Inlet Pressure (ΔPs) shown																																									
					Minimum ΔPs							0.5" w.g. (125Pa) ΔPs							1.0" w.g. (250Pa) ΔPs							1.5" w.g. (375Pa) ΔPs							2.0" w.g. (500Pa) ΔPs							3.0" w.g. (750Pa) ΔPs						
					2	3	4	5	6	7	2	3	4	5	6	7	2	3	4	5	6	7	2	3	4	5	6	7	2	3	4	5	6	7	2	3	4	5	6	7						
4	200	94	0.63	157	52	49	45	37	28	23	*	*	*	*	*	*	55	50	45	39	28	24	57	52	46	41	28	24	57	53	47	43	28	25	57	54	48	46	29	27						
	150	71	0.37	92	48	43	40	32	21	-	47	43	39	32	21	-	52	47	41	35	22	-	53	48	42	38	22	-	53	49	43	40	23	21	52	48	43	42	25	25						
	100	47	0.17	42	-	37	33	22	-	-	-	39	33	27	-	-	48	42	36	32	-	-	47	42	37	35	-	-	48	43	37	36	-	20	48	42	37	36	20	24						
	50	24	0.05	12	-	-	-	-	-	-	-	-	23	20	-	-	-	-	25	24	-	-	-	-	35	27	26	-	-	-	35	27	25	-	-	-	37	27	26	-						
	30	14	0.02	5	-	-	-	-	-	-	-	-	-	-	-	-	-	-	-	-	-	-	-	-	-	-	-	-	-	-	-	-	-	-	-	-	36	22	21	-						
5	300	142	0.55	137	49	52	49	41	26	21	*	*	*	*	*	*	56	53	49	41	26	22	59	56	49	43	27	23	61	57	50	44	27	24	61	58	52	46	29	27						
	250	118	0.35	87	-	48	44	36	20	-	-	48	44	36	-	-	56	51	44	38	20	-	57	53	46	40	22	-	57	54	47	41	23	-	58	55	48	45	26	26						
	200	94	0.23	57	-	43	38	30	-	-	-	44	39	32	-	-	54	49	40	35	-	-	54	50	42	37	-	-	55	51	43	39	20	-	55	51	45	43	24	24						
	125	59	0.10	25	-	-	28	-	-	-	-	39	30	25	-	-	-	42	35	31	-	-	-	43	37	34	-	-	-	44	37	36	-	-	-	44	38	37	23	25						
	100	47	0.06	15	-	-	23	-	-	-	-	-	28	23	-	-	-	39	32	29	-	-	-	-	40	34	31	-	-	-	40	34	33	-	-	-	40	34	33	20						
6	450	212	0.38	94	53	48	41	34	23	22	53	49	42	35	24	22	61	53	44	38	24	24	65	59	47	41	26	26	67	61	50	43	27	27	68	63	55	46	30	30						
	400	189	0.30	75	51	46	39	31	20	-	53	48	40	33	21	-	61	53	43	36	22	21	64	58	46	40	24	24	65	60	50	42	25	25	66	62	54	45	29	28						
	300	142	0.18	45	-	39	33	25	-	-	51	44	36	29	-	-	59	51	40	33	-	-	60	55	45	38	21	-	61	57	48	40	23	21	61	57	51	44	26	25						
	200	94	0.08	20	-	-	-	-	-	-	49	41	31	24	-	-	53	49	38	30	-	-	54	50	43	34	-	-	55	51	45	37	-	-	54	51	46	41	22	23						
	100	47	0.02	5	-	-	-	-	-	-	-	38	27	-	-	-	-	40	33	26	-	-	-	39	34	29	-	-	-	39	36	31	-	20	-	40	36	32	20	26						
7	650	307	0.49	122	57	52	46	43	29	31	*	*	*	*	*	*	60	54	47	42	29	32	65	57	49	46	31	34	69	60	51	47	33	36	71	64	54	50	35	38						
	550	260	0.35	87	54	48	42	38	24	25	56	49	42	36	24	25	60	53	45	40	26	27	65	56	47	44	29	31	67	59	48	46	31	33	69	62	52	48	33	36						
	335	158	0.13	32	-	37	30	24	-	-	53	43	34	30	-	-	59	49	38	35	-	21	60	53	42	38	22	25	60	54	44	40	24	28	60	54	47	44	27	33						
	225	106	0.06	15	-	-	-	-	-	-	51	40	29	25	-	-	53	46	35	30	-	-	53	47	39	34	20	24	53	48	40	37	21	28	53	48	41	38	24	33						
	110	52	0.02	5	-	-	-	-	-	-	-	-	24	22	-	-	-	-	27	28	-	-	-	37	29	29	20	24	47	38	29	29	20	28	47	39	31	30	22	33						
8	800	378	0.35	87	51	49	44	40	27	27	58	52	45	38	27	27	65	56	47	42	29	32	69	60	50	44	31	35	71	63	52	46	33	37	73	66	55	48	35	40						
	700	330	0.27	67	-	46	42	36	25	23	58	51	43	37	25	23	64	55	46	40	28	31	67	58	48	43	29	33	69	61	50	44	31	35	71	65	54	48	34	38						
	600	283	0.20	50	-	43	39	33	21	-	56	49	41	36	23	-	62	53	44	39	25	28	66	58	47	42	28	31	67	60	49	43	30	33	68	63	53	46	33	37						
	400	189	0.09	22	-	37	32	21	-	-	52	44	36	31	-	-	58	51	40	38	20	23	60	54	43	38	23	27	61	56	46	41	27	31	61	57	49	43	30	36						
	175	83	0.02	5	-	-	-	-	-	-	-	40	28	24	-	-	-	44	38	33	21	22	-	44	37	36	24	27	-	43	42	38	26	31	51	44	39	38	29	36						
9	1050	495	0.37	92	54	53	50	44	33	33	56	54	50	45	33	33	63	58	51	46	35	35	68	61	53	48	38	37	70	64	54	50	39	39	73	67	57	52	45	44						
	900	425	0.27	67	51	50	46	40	28	26	58	53	47	41	31	29	63	56	48	43	32	31	67	60	51	47	36	35	69	63	53	48	37	36	71	66	56	50	39	39						
	675	319	0.15	37	49	45	40	31	-	-	53	49	41	35	-	-	60	54	44	40	25	25	64	58	47	43	29	30	65	60	49	45	32	32	67	62	53	48	35	36						
	450	212	0.07	17	-	-	30	20	-	-	51	44	34	30	-	-	56	51	39	35	21	-	59	54	43	38	25	26	60	55	45	41	28	30	59	56	48	43	30	35						
	225	106	0.02	5	-	-	-	-	-	-	-	37	26	23	-	-	-	49	43	33	21	-	-	54	44	35	33	24	25	53	46	36	35	27	30	52	47	38	37	29	36					
10	1350	637	0.38	94	57	51	45	43	34	34	57	52	46	42	35	34	66	59	51	45	36	36	71	63	54	49	37	39	73	65	56	50	39	41	76	69	59	52	42	44						
	1100	519	0.25	62	55	46	41	37	28	25	59	52	44	39	29	26	66	58	48	43	31	32	69	61	52	46	34	36	71	64	54	48	37	39	73	67	58	51	41	43						
	825	389	0.15	37	-	39	35	29	-	-	56	49	40	34	21	20	64	55	45	39	27	29	66	59	49	43	32	33	67	61	51	44	34	36	68	63	54	47	37	40						
	550	260	0.07	17	-	-	26	-	-	-	52	45	36	29	-	-	58	52	41	35	23	24	62	55	45	37	27	29	61	56	47	39	29	32	62	57	50	42	32	37						
	275	130	0.02	5	-	-	-	-	-	-	-	39	28	22	-	-	-	50	44	35	29	20	-	54	46	38	33	26	28	52	46	39	35	28	32	55	47	40	37	32	38					
12	2000	944	0.37	92	61	54	48	45	39	37	63	56	49	45	39	37	68	62	53	48	40	40	72	65	56	51	42	42	74	67	58	53	43	44	77	70	62	55	45	47						
	1600	755	0.24	60	55	49	43	39	32	27	60	54	46	42	33	30	66	59	50	45	35	35	69	63	54	49	38	39	71	65	56	50	40	41	74	69	61	53	43	45						
	1200	566	0.14	35	51	43	37	31	21	-	60	52	44	40	30	29	63	56	48	43	31	33	66	60	51	45	35	36	68	63	54	47	37	39	73	69	61	52	43	45						
	800	378	0.06	15	48	36	28	20	-	-	58	50	42	37	28	29	60	54	44	38	27	29	63	57	48	41	30	33	63	58	50	43	31	34	65	60	53	46	35	39						
	400	189	0.02	5	-	-	-	-	-	-	51	42	32	26	-	-	-	54	47	37	32	21	23	-	56	49	41	36	27	30	-	56	50	43	39	30	59	51	46	42	34	40				
14	2700	1274	0.54	134	65	59	53	48	41	40	*	*	*	*	*	*	71	65	56	51	42	42	75	67	59	52	43	44	76	69</																

Performance Data • Radiated Sound Power Levels
30X Series • Optional Attenuator
Fiberglass Liner

Inlet Size	Airflow		Min. inlet ΔPs		Sound Power Octave Bands @ Inlet Pressure (ΔPs) shown																																									
					Minimum ΔPs							0.5" w.g. (125Pa) ΔPs							1.0" w.g. (250Pa) ΔPs							1.5" w.g. (375Pa) ΔPs							2.0" w.g. (500Pa) ΔPs							3.0" w.g. (750Pa) ΔPs						
					2	3	4	5	6	7	2	3	4	5	6	7	2	3	4	5	6	7	2	3	4	5	6	7	2	3	4	5	6	7	2	3	4	5	6	7						
4	200	94	0.63	159	52	42	33	27	27	21	*	*	*	*	*	*	55	43	34	28	27	22	59	49	39	33	28	23	59	50	41	36	29	25	58	50	44	39	32	28						
	150	71	0.37	92	48	35	27	-	-	-	49	36	27	-	-	-	54	43	33	27	21	-	54	45	37	31	23	-	54	45	39	33	26	22	52	44	40	26	29	26						
	100	47	0.17	43	-	-	-	-	-	-	47	35	24	-	-	-	47	38	30	24	-	-	49	39	33	28	-	-	49	38	33	29	23	21	48	38	34	32	29	26						
	50	24	0.05	12	-	-	-	-	-	-	-	-	-	-	-	-	-	-	-	-	-	-	-	-	24	23	-	-	-	31	26	25	23	-	47	36	31	30	28	25						
	30	14	0.02	5	-	-	-	-	-	-	-	-	-	-	-	-	-	-	-	-	-	-	-	-	24	23	-	-	-	32	26	25	24	-	-	35	31	30	28	26						
5	300	142	0.55	136	51	42	35	27	25	-	*	*	*	*	*	*	55	45	37	31	26	21	60	50	40	35	29	23	62	53	42	37	32	26	62	53	47	41	37	31						
	250	118	0.35	87	-	39	31	23	-	-	-	39	32	23	-	-	55	44	35	30	22	-	58	49	39	34	27	21	59	50	42	36	30	24	59	51	45	40	35	30						
	200	94	0.23	57	-	-	-	-	-	-	-	37	29	21	-	-	53	44	34	29	-	-	55	46	38	33	25	-	54	47	40	35	29	24	53	47	42	38	33	29						
	125	59	0.10	25	-	-	-	-	-	-	-	-	-	-	-	-	-	39	33	27	-	-	-	40	35	30	23	-	-	39	36	31	27	23	-	40	36	34	32	29						
	100	47	0.06	15	-	-	-	-	-	-	-	-	-	-	-	-	-	36	30	24	-	-	-	40	35	30	23	-	-	35	32	29	27	23	-	37	33	32	32	28						
6	450	212	0.38	94	53	43	35	28	25	-	54	44	35	28	25	-	61	49	39	31	28	22	64	54	42	35	30	24	65	57	46	38	33	27	65	58	51	42	37	31						
	400	189	0.30	75	51	40	33	24	-	-	54	42	33	26	21	-	60	47	36	30	24	-	62	52	41	34	28	22	63	55	44	36	31	25	63	57	49	41	35	30						
	300	142	0.18	44	-	34	25	-	-	-	51	38	29	22	-	-	56	46	35	28	21	-	59	50	40	33	26	-	58	51	42	35	29	22	58	51	46	40	34	28						
	200	94	0.08	21	-	-	-	-	-	-	49	36	27	21	-	-	52	44	34	27	-	-	53	46	39	31	24	-	51	47	40	33	27	22	50	46	42	37	31	26						
	100	47	0.02	6	-	-	-	-	-	-	-	34	23	-	-	-	-	28	23	-	-	-	-	36	30	26	21	-	-	34	32	28	24	21	-	37	33	31	28	26						
7	650	307	0.50	125	56	50	42	33	27	25	56	50	42	33	27	25	59	52	42	35	30	27	64	54	46	41	34	29	67	56	47	44	36	31	69	59	50	47	39	34						
	550	259	0.35	88	53	46	38	28	24	-	54	43	34	26	25	-	59	49	41	35	29	23	64	52	44	40	32	27	66	54	45	42	34	29	67	57	48	45	37	32						
	335	158	0.13	34	-	-	-	-	-	-	-	37	31	26	-	-	55	44	35	31	22	-	58	48	38	34	27	21	58	49	40	35	29	25	58	50	43	38	33	30						
	225	106	0.06	16	-	-	-	-	-	-	-	26	21	-	-	-	51	41	32	26	-	-	51	44	36	30	25	21	52	43	37	32	28	25	50	43	39	36	32	31						
	110	52	0.02	4	-	-	-	-	-	-	-	-	-	-	-	-	-	25	23	-	-	-	-	28	27	25	22	-	30	28	28	25	-	39	34	33	31	30								
8	800	377	0.35	87	57	47	41	32	26	20	59	48	40	31	26	21	63	53	45	37	31	27	66	55	45	38	33	29	68	57	47	39	35	31	70	60	50	42	38	36						
	700	330	0.27	68	53	44	38	29	22	-	57	46	37	28	23	-	62	50	41	34	29	25	65	53	43	36	32	27	67	56	45	38	33	29	68	58	49	41	37	34						
	600	283	0.20	51	50	40	34	26	-	-	54	43	35	27	-	-	61	48	39	32	26	21	64	52	42	35	30	26	65	55	44	37	32	28	65	57	48	40	36	33						
	400	189	0.09	24	51	38	30	22	-	-	50	38	31	25	-	-	56	45	36	30	22	-	58	49	39	33	27	22	58	50	42	35	30	25	58	51	44	38	34	31						
	175	83	0.02	5	-	-	-	-	-	-	50	40	30	25	-	-	-	36	31	27	23	-	-	37	33	30	26	23	-	38	34	31	30	27	49	42	36	34	33	31						
9	1050	495	0.39	98	59	50	44	34	30	28	59	49	43	34	31	28	63	53	45	36	32	28	66	56	49	41	36	32	68	58	52	44	36	32	70	61	56	48	40	35						
	900	425	0.29	73	54	46	40	30	25	21	57	47	39	31	26	21	61	51	44	35	29	-	64	54	48	40	32	26	66	56	51	43	35	29	68	60	54	47	40	34						
	675	318	0.16	40	-	40	33	23	-	-	54	44	36	28	21	-	58	49	42	34	26	-	61	52	47	39	31	24	63	54	49	42	34	28	64	56	52	45	37	32						
	450	212	0.07	17	-	-	-	-	-	-	52	39	33	26	-	-	54	45	41	33	24	-	56	48	43	36	28	22	57	50	44	38	30	25	57	51	46	41	34	30						
	225	106	0.02	4	-	-	-	-	-	-	-	-	-	-	-	-	50	38	31	27	-	-	51	39	34	31	25	21	50	40	36	33	28	24	50	42	39	36	31	29						
10	1350	637	0.44	110	56	48	40	34	32	25	56	49	40	33	32	25	63	53	43	37	34	27	67	56	46	39	35	30	70	59	48	41	37	31	73	63	53	45	40	35						
	1100	519	0.29	73	52	43	34	28	23	-	56	46	37	31	35	-	63	50	40	34	29	22	66	55	44	37	32	26	68	57	47	39	35	29	71	61	51	44	39	34						
	825	389	0.16	40	-	39	29	-	-	-	53	42	33	27	-	-	59	48	38	32	25	-	63	53	43	36	30	24	64	55	45	38	33	27	65	58	49	41	36	32						
	550	259	0.07	17	-	-	-	-	-	-	50	39	30	23	-	-	56	46	37	30	23	-	57	49	40	32	27	23	58	51	42	34	29	25	60	55	47	40	35	32						
	275	130	0.02	4	-	-	-	-	-	-	-	-	-	-	-	-	-	39	30	23	-	-	-	54	42	33	27	23	49	43	35	30	26	25	54	46	38	33	31	30						
12	2000	943	0.41	103	60	50	44	35	34	29	60	49	44	35	34	29	69	58	50	41	38	34	69	59	52	45	43	40	71	60	51	43	39	36	74	64	55	47	43	40						
	1600	755	0.27	68	54	47	42	37	39	33	57	50	45	41	46	40	64	53	46	41	43	38	67	57	48	41	40	35	69	59	50	42	38	35	70	62	53	45	42	39						
	1200	566	0.15	38	48	37	31	21	-	-	55	45	36	29	27	24	61	50	42	34	30	27	63	54	45	37	33	31	64	56	47	39	35	33	66	59	51	43	40	38						
	800	377	0.07	17	-	-	-	-	-	-	51	41	32	24	-	-	56	47	38	30	25	22	58	50	42	34	31	29	58	52	44	36	33	32	60	54	47	40	38	38						
	400	189	0.02	4	-	-	-	-	-	-	-	35	26	-	-	-	49	39	32	27	26	25	52	41	35	31	32	31	50	42	35	33	34	32	52	44	38	36	38	39						
14	2700	1274	0.58	145	65	57	53	42	35	31	*	*	*	*	*	*	67	58	50	41	38	34	69	60	51	43	37	34	71	62	52	44	39	35	73	65	55	48	42	38						
	2100	991	0.34	85	59	50	46	35	29	22	59</																																			

Performance Data • NC Level Application Guide

30X Series • Optional Attenuator

Steri-Liner

Inlet Size	Airflow cfm / s		Min. inlet ΔPs "w.g. Pa		NC Levels @ Inlet Pressure (ΔPs) shown											
					DISCHARGE					RADIATED						
					Min. ΔPs	0.5" w.g. (125 Pa)	1.0" w.g. (250 Pa)	1.5" w.g. (375 Pa)	2.0" w.g. (500 Pa)	3.0" w.g. (750 Pa)	Min. ΔPs	0.5" w.g. (125 Pa)	1.0" w.g. (250 Pa)	1.5" w.g. (375 Pa)	2.0" w.g. (500 Pa)	3.0" w.g. (750 Pa)
4	200	94	0.63	159	-	*	-	-	-	-	-	*	-	21	21	20
	150	71	0.37	92	-	-	-	-	-	-	-	-	21	-	-	-
	100	47	0.17	43	-	-	-	-	-	-	-	-	-	-	-	-
	50	24	0.05	12	-	-	-	-	-	-	-	-	-	-	-	-
	30	14	0.02	5	-	-	-	-	-	-	-	-	-	-	-	-
5	300	142	0.55	136	-	*	-	-	-	-	-	*	-	23	29	29
	250	118	0.35	87	-	-	-	-	-	-	-	-	-	20	26	26
	200	94	0.23	57	-	-	-	-	-	-	-	-	-	-	20	20
	125	59	0.10	25	-	-	-	-	-	-	-	-	-	-	-	-
	100	47	0.06	15	-	-	-	-	-	-	-	-	-	-	-	-
6	450	212	0.38	94	-	-	-	-	-	21	-	-	24	28	29	29
	400	189	0.30	75	-	-	-	-	-	-	-	-	23	25	26	26
	300	142	0.18	44	-	-	-	-	-	-	-	-	-	21	20	20
	200	94	0.08	21	-	-	-	-	-	-	-	-	-	-	-	-
	100	47	0.02	6	-	-	-	-	-	-	-	-	-	-	-	-
7	650	307	0.50	125	-	-	-	-	23	25	-	-	21	28	31	34
	550	259	0.35	88	-	-	-	-	20	23	-	-	21	28	30	31
	335	158	0.13	34	-	-	-	-	-	-	-	-	-	20	20	20
	225	106	0.06	16	-	-	-	-	-	-	-	-	-	-	-	-
	110	52	0.02	4	-	-	-	-	-	-	-	-	-	-	-	-
8	800	377	0.35	87	-	-	-	-	21	25	-	21	26	30	33	35
	700	330	0.27	68	-	-	-	-	20	23	-	-	25	29	31	33
	600	283	0.20	51	-	-	-	-	-	21	-	-	24	28	29	29
	400	189	0.09	24	-	-	-	-	-	-	-	-	-	20	20	20
	175	83	0.02	5	-	-	-	-	-	-	-	-	-	-	-	-
9	1050	495	0.39	98	-	-	-	20	23	25	21	21	26	30	33	35
	900	425	0.28	70	-	-	-	-	20	23	-	-	24	28	30	33
	675	318	0.16	40	-	-	-	-	-	20	-	-	20	24	26	28
	450	212	0.07	17	-	-	-	-	-	-	-	-	-	-	-	20
	225	106	0.02	4	-	-	-	-	-	-	-	-	-	-	-	-
10	1350	637	0.42	105	-	-	-	21	25	30	-	-	26	31	35	39
	1100	519	0.30	75	-	-	-	20	23	25	-	-	26	30	33	36
	825	389	0.15	37	-	-	-	-	-	-	-	-	21	26	28	29
	550	259	0.07	17	-	-	-	-	-	-	-	-	-	-	20	24
	275	130	0.02	4	-	-	-	-	-	-	-	-	-	-	-	-
12	2000	943	0.41	103	-	-	-	25	28	30	23	23	34	34	36	40
	1600	755	0.27	68	-	-	-	23	24	28	-	-	28	31	34	35
	1200	566	0.15	38	-	-	-	-	20	23	-	-	24	26	28	30
	800	377	0.07	18	-	-	-	-	-	-	-	-	-	20	20	23
	400	189	0.02	4	-	-	-	-	-	-	-	-	-	-	-	-
14	2700	1274	0.58	145	-	*	24	28	30	34	29	*	31	34	36	39
	2100	991	0.34	85	-	-	21	25	28	28	21	21	28	31	33	35
	1550	731	0.18	46	-	-	-	-	-	20	-	-	23	25	25	28
	1050	495	0.09	22	-	-	-	-	-	-	-	-	-	-	20	21
	525	248	0.02	6	-	-	-	-	-	-	-	-	-	-	-	-
16	3500	1651	0.48	119	-	-	23	28	30	33	30	30	31	35	38	41
	2800	1321	0.31	77	-	-	23	25	28	30	21	23	29	33	34	36
	2100	991	0.18	44	-	-	-	21	23	24	-	-	23	26	29	31
	1400	660	0.08	20	-	-	-	-	-	-	-	-	-	20	21	23
	700	330	0.02	5	-	-	-	-	-	-	-	-	-	-	-	-
24 x 16	5350	2525	0.47	118	26	26	28	34	34	39	40	40	36	38	40	43
	5000	2360	0.40	100	25	25	26	33	33	38	39	39	35	36	39	41
	4000	1887	0.26	65	-	20	25	30	33	36	30	30	31	34	35	36
	3000	1415	0.15	38	-	-	23	28	29	31	20	21	25	30	31	33
2000	943	0.07	18	-	-	-	21	25	28	-	-	21	24	26	29	

Performance Notes:

1. NC Levels are calculated based on procedures as outlined on page A101.
2. Dash (-) in space indicates a NC less than 20.
3. Asterisk (*) in space indicates that the minimum inlet static pressure requirement is greater than 0.5" w.g. (125 Pa) at rated airflow.

A
SINGLE DUCT TERMINAL UNITS

Performance Data • Discharge Sound Power Levels
30X Series • Optional Attenuator
Steri-Liner

Inlet Size	Airflow		Min. inlet ΔPs		Sound Power Octave Bands @ Inlet Pressure (ΔPs) shown																																									
					Minimum ΔPs							0.5" w.g. (125Pa) ΔPs							1.0" w.g. (250Pa) ΔPs							1.5" w.g. (375Pa) ΔPs							2.0" w.g. (500Pa) ΔPs							3.0" w.g. (750Pa) ΔPs						
					2	3	4	5	6	7	2	3	4	5	6	7	2	3	4	5	6	7	2	3	4	5	6	7	2	3	4	5	6	7	2	3	4	5	6	7						
4	200	94	0.63	157	51	49	45	40	43	41	*	*	*	*	*	*	54	50	45	41	43	42	57	52	46	43	43	42	57	53	47	45	43	42	57	53	48	47	44	44						
	150	71	0.37	92	-	42	39	35	35	33	-	43	39	35	36	33	52	46	40	37	36	33	53	48	42	40	37	35	52	48	43	42	37	37	52	48	44	44	39	40						
	100	47	0.17	42	-	34	32	24	23	-	-	38	33	28	24	-	46	41	35	33	27	26	46	42	37	36	29	31	-	41	37	38	31	34	47	41	37	38	34	38						
	50	24	0.05	12	-	-	-	-	-	-	-	-	20	-	-	-	-	-	23	24	-	22	-	-	25	26	26	28	-	-	25	26	28	32	-	-	25	26	30	35						
	30	14	0.02	5	-	-	-	-	-	-	-	-	-	-	-	-	-	-	-	-	-	-	-	-	-	21	26	-	-	21	20	23	27	-	-	22	22	28	32							
5	300	142	0.55	137	50	51	50	44	42	42	*	*	*	*	*	*	56	52	50	44	43	42	60	55	51	45	43	43	62	57	51	47	43	44	62	57	53	49	45	46						
	250	118	0.35	87	48	46	44	38	36	34	49	47	44	38	35	34	56	50	45	40	36	35	57	53	46	42	38	37	58	53	47	44	39	39	58	54	49	47	41	43						
	200	94	0.23	57	-	42	40	34	29	26	-	43	39	34	29	26	53	48	41	37	31	30	55	50	43	40	34	34	54	50	44	42	36	37	55	50	46	45	39	41						
	125	59	0.10	25	-	-	29	21	-	-	-	39	31	27	-	-	50	43	35	32	25	26	50	43	37	36	30	32	49	44	38	38	33	36	49	43	38	39	37	41						
	100	47	0.06	15	-	-	22	-	-	-	-	37	27	25	-	-	-	40	32	31	25	26	50	40	34	34	30	32	-	41	35	35	33	36	-	39	34	35	36	40						
6	450	212	0.38	94	51	47	42	38	43	41	52	49	43	39	43	41	60	53	45	41	44	42	64	58	48	43	44	43	65	61	50	46	45	44	66	63	55	49	47	46						
	400	189	0.30	75	-	44	39	35	38	36	52	47	41	36	38	36	59	52	44	39	39	39	63	58	47	42	40	40	64	60	50	45	41	42	64	61	55	49	44	45						
	300	142	0.18	45	-	-	34	29	28	25	-	42	37	32	31	29	57	51	41	36	32	33	59	55	46	40	35	35	60	57	49	43	38	38	59	57	52	47	41	41						
	200	94	0.08	20	-	-	-	-	-	-	-	-	31	27	22	21	52	48	38	33	27	27	55	50	44	37	31	32	55	51	46	40	33	35	55	52	49	45	39	40						
	100	47	0.02	5	-	-	-	-	-	-	-	-	-	-	-	-	-	-	33	29	25	26	53	40	36	32	31	33	54	41	37	34	34	36	-	-	37	35	37	41						
7	650	307	0.49	122	57	53	47	47	43	46	*	*	*	*	*	*	60	54	48	45	44	47	66	57	50	49	45	48	69	60	52	51	46	49	71	64	55	53	49	51						
	550	260	0.35	87	54	48	42	42	39	39	57	49	42	40	39	40	60	53	45	44	40	41	65	56	48	47	42	44	67	59	49	48	44	45	69	61	53	51	47	49						
	335	158	0.13	32	48	39	30	28	22	-	53	43	35	33	27	27	58	49	39	38	32	34	60	52	42	41	36	38	60	53	45	43	38	41	60	54	48	47	41	45						
	225	106	0.06	15	45	36	20	-	-	-	51	41	30	28	21	23	53	46	35	33	28	32	54	47	40	38	33	37	54	47	41	40	35	40	53	47	42	42	39	44						
	110	52	0.02	5	44	36	-	-	-	-	52	38	25	25	-	20	46	36	29	31	28	28	46	38	31	33	33	36	47	38	31	33	35	39	48	40	33	34	38	44						
8	800	378	0.35	87	52	49	45	43	42	41	59	52	46	41	42	41	65	56	48	44	44	45	68	60	51	46	45	47	70	62	52	48	47	48	73	66	56	51	49	52						
	700	330	0.27	67	48	46	43	40	38	35	58	51	44	40	39	36	63	55	47	43	42	42	67	58	49	45	43	45	69	61	51	46	45	47	70	65	54	49	48	50						
	600	283	0.20	50	48	44	40	36	33	30	56	49	42	39	36	33	62	53	45	41	38	40	65	58	47	44	41	43	66	60	49	45	43	45	68	63	53	48	47	49						
	400	189	0.09	22	-	38	32	24	-	-	51	44	36	33	27	26	59	51	41	39	34	35	60	54	44	40	37	38	60	56	47	42	40	42	61	57	50	45	44	46						
	175	83	0.02	5	-	-	-	-	-	-	50	42	29	27	20	21	49	42	35	32	30	31	50	43	37	41	36	37	50	43	38	37	40	42	52	43	39	39	43	47						
9	1050	495	0.37	92	55	52	50	47	47	47	57	53	50	47	46	47	64	57	52	48	47	47	69	60	54	51	49	49	71	63	55	53	50	50	73	67	58	55	53	53						
	900	425	0.27	67	52	49	47	43	40	39	59	52	47	44	41	39	63	55	49	46	43	42	68	59	52	49	45	45	69	62	53	51	48	48	71	65	57	53	52	51						
	675	319	0.15	37	47	44	40	35	29	27	53	48	41	38	32	30	61	53	45	43	38	37	64	57	48	46	42	42	65	59	50	47	45	45	67	61	54	50	48	49						
	450	212	0.07	17	-	36	29	21	-	-	52	44	36	33	27	27	58	50	40	38	35	34	59	53	44	41	38	39	60	55	47	44	41	42	60	55	49	46	44	47						
	225	106	0.02	5	-	33	-	-	-	-	48	39	29	26	22	21	51	42	34	34	32	31	52	44	37	36	38	38	51	45	40	38	40	41	52	47	39	40	43	47						
10	1350	637	0.38	94	55	50	46	46	48	45	59	52	47	46	48	45	66	59	52	49	49	47	70	62	55	51	50	50	73	65	57	53	52	52	77	69	60	56	55	55						
	1100	519	0.25	62	54	45	42	41	40	35	58	51	45	43	41	38	65	56	49	45	43	42	69	61	53	49	47	47	71	63	55	50	49	50	73	66	58	53	52	53						
	825	389	0.15	37	47	39	35	32	28	23	56	48	41	37	32	32	62	54	46	41	39	40	65	58	50	45	44	45	66	60	52	47	46	47	67	62	55	50	49	51						
	550	260	0.07	17	-	-	25	20	-	-	53	44	36	32	29	30	58	51	42	38	36	36	60	54	46	40	40	41	61	55	48	42	41	43	61	57	50	45	45	48						
	275	130	0.02	5	-	-	-	-	-	-	48	39	29	25	23	23	51	44	35	32	33	32	53	46	39	36	38	39	52	45	40	38	41	43	54	46	42	40	45	49						
12	2000	944	0.37	92	60	54	49	47	49	45	64	56	50	48	49	45	68	61	54	51	51	49	73	64	57	54	52	52	75	67	59	55	54	54	77	70	62	58	56	57						
	1600	755	0.24	60	55	48	44	41	42	36	61	53	47	44	43	39	67	59	51	48	46	45	71	63	55	52	48	49	72	65	57	53	51	52	75	68	60	55	54	55						
	1200	566	0.14	35	49	42	37	33	30	25	58	50	42	39	36	35	64	56	49	46	42	43	67	60	52	48	46	47	69	62	54	50	48	49	71	65	58	53	51	52						
	800	378	0.06	15	-	-	28	22	-	-	54	46	38	35	31	33	60	53	44	41	38	38	63	57	48	44	41	42	64	58	50	45	43	45	65	60	54	49	47	49						
	400	189	0.02	5	-	-	-	-	-	-	50	41	32	28	24	25	54	46	38	35	33	33	57	50	43	39	38	39	56	49	44	40	41	43	58	50	47	44	45	49						
14	2700	1274	0.54	134																																										

Performance Data • Radiated Sound Power Levels

30X Series • Optional Attenuator

Steri-Liner

SINGLE DUCT TERMINAL UNITS

Inlet Size	Airflow		Min. inlet ΔPs		Sound Power Octave Bands @ Inlet Pressure (ΔPs) shown																																									
					Minimum ΔPs							0.5" w.g. (125Pa) ΔPs							1.0" w.g. (250Pa) ΔPs							1.5" w.g. (375Pa) ΔPs							2.0" w.g. (500Pa) ΔPs							3.0" w.g. (750Pa) ΔPs						
					2	3	4	5	6	7	2	3	4	5	6	7	2	3	4	5	6	7	2	3	4	5	6	7	2	3	4	5	6	7	2	3	4	5	6	7						
4	200	94	0.63	157	52	42	33	27	27	21	*	*	*	*	*	*	55	43	34	28	27	22	59	49	39	33	28	23	59	50	41	36	29	25	58	50	44	38	32	28						
	150	71	0.37	92	48	35	27	-	-	-	49	36	27	-	-	-	54	53	33	27	21	-	54	45	37	31	23	19	54	45	39	33	26	22	52	44	40	36	29	26						
	100	47	0.17	42	-	-	-	-	-	-	47	35	24	-	-	-	47	38	30	24	-	-	49	39	33	28	-	-	49	38	33	29	23	21	48	38	34	29	26	26						
	50	24	0.05	12	-	-	-	-	-	-	-	-	-	-	-	-	-	-	-	-	-	-	-	-	24	23	-	-	-	31	26	25	23	-	47	36	31	30	28	25						
	30	14	0.02	5	-	-	-	-	-	-	-	-	-	-	-	-	-	-	-	-	-	-	-	-	24	23	-	-	-	32	26	25	24	-	-	35	31	30	28	26						
5	300	142	0.55	137	51	42	35	27	25	-	*	*	*	*	*	*	55	45	37	31	26	21	60	50	40	35	30	24	65	57	46	38	33	27	65	58	51	42	37	31						
	250	118	0.35	87	-	39	31	23	-	-	-	39	32	26	-	-	55	44	35	30	22	-	58	49	39	34	28	22	63	55	44	36	31	25	63	57	49	41	35	30						
	200	94	0.23	57	-	-	-	-	-	-	-	37	29	21	-	-	53	44	34	29	-	-	55	46	38	33	26	-	58	51	42	35	29	22	58	51	46	40	34	28						
	125	59	0.10	25	-	-	-	-	-	-	-	-	-	-	-	-	-	39	33	27	-	-	-	40	35	31	24	-	51	47	40	33	27	22	50	46	42	37	31	26						
	100	47	0.06	15	-	-	-	-	-	-	-	-	-	-	-	-	-	36	30	24	-	-	-	36	32	26	21	-	-	47	40	33	27	22	-	37	33	31	28	26						
6	450	212	0.38	94	53	43	35	28	25	-	54	44	35	28	25	-	61	49	39	31	28	22	64	54	42	35	30	24	65	57	46	38	33	27	65	58	51	42	37	31						
	400	189	0.30	75	51	40	33	24	-	-	54	42	33	26	21	-	60	47	36	30	24	-	62	52	41	34	28	22	63	55	44	36	31	25	63	57	49	41	35	30						
	300	142	0.18	45	-	34	25	-	-	-	51	38	29	22	-	-	56	46	35	28	21	-	59	50	40	33	26	-	58	51	42	35	29	22	58	51	46	40	34	28						
	200	94	0.08	20	-	-	-	-	-	-	49	36	27	21	-	-	52	44	34	27	-	-	53	46	39	31	24	-	51	47	40	33	27	22	50	46	42	37	31	26						
	100	47	0.02	5	-	-	-	-	-	-	-	34	23	-	-	-	-	28	23	-	-	-	-	36	30	26	21	-	-	34	32	28	24	21	-	37	33	31	28	26						
7	650	307	0.49	122	56	50	42	33	27	25	56	50	42	33	27	25	59	52	42	35	30	27	64	54	46	41	34	29	67	56	47	44	36	31	69	59	50	47	39	34						
	550	260	0.35	87	53	46	38	28	24	-	54	43	34	26	25	-	59	49	41	35	29	23	64	52	44	40	32	27	66	54	45	42	34	29	67	57	48	45	37	32						
	335	158	0.13	32	-	-	-	-	-	-	-	37	31	26	-	-	55	44	35	31	22	-	58	48	38	34	27	21	58	49	40	35	29	25	58	50	43	38	33	30						
	225	106	0.06	15	-	-	-	-	-	-	-	26	21	-	-	-	51	41	32	26	-	-	51	44	36	30	25	21	52	43	37	32	28	25	50	43	39	36	32	31						
	110	52	0.02	5	-	-	-	-	-	-	-	-	-	-	-	-	-	25	23	-	-	-	-	28	27	25	22	-	30	28	28	25	-	39	34	33	31	30								
8	800	378	0.35	87	57	47	41	32	26	20	59	48	40	31	26	21	63	53	45	37	31	27	66	55	45	38	33	29	68	57	47	39	35	31	70	60	50	42	38	36						
	700	330	0.27	67	53	44	38	29	22	-	57	46	37	28	23	-	62	50	41	34	29	25	65	53	43	36	32	27	67	56	45	38	33	29	68	58	49	41	37	34						
	600	283	0.20	50	50	40	34	26	-	-	54	43	35	27	-	-	61	48	39	32	26	21	64	52	42	35	30	26	65	55	44	37	32	28	65	57	48	40	36	33						
	400	189	0.09	22	51	38	30	22	-	-	50	38	31	25	-	-	56	45	36	30	22	-	58	49	39	33	27	22	58	50	42	35	30	25	58	51	44	38	34	31						
	175	83	0.02	5	-	-	-	-	-	-	50	40	30	25	-	-	-	36	31	27	23	-	-	37	33	30	26	23	-	38	34	31	30	27	49	42	36	34	33	31						
9	1050	495	0.37	92	59	50	44	34	30	28	59	49	43	34	31	28	63	53	45	36	32	28	66	56	49	41	36	32	68	58	52	44	36	32	70	61	56	48	40	35						
	900	425	0.27	67	54	46	40	30	25	21	57	47	39	31	26	21	61	51	44	35	29	22	64	54	48	40	32	26	66	56	51	43	35	29	68	60	54	47	40	34						
	675	319	0.15	37	-	40	33	23	-	-	54	44	36	28	21	-	58	49	42	34	26	-	61	52	47	39	31	24	63	54	49	42	34	28	64	56	52	45	37	32						
	450	212	0.07	17	-	-	-	-	-	-	52	39	33	26	-	-	54	45	41	33	24	-	56	48	43	36	28	22	57	50	44	38	30	25	57	51	46	41	34	30						
	225	106	0.02	5	-	-	-	-	-	-	-	35	26	-	-	-	50	38	31	27	-	-	51	39	34	31	25	21	50	40	36	33	28	24	50	42	39	36	31	29						
10	1350	637	0.38	94	56	48	40	34	32	25	56	49	40	33	32	25	63	53	43	37	34	27	67	56	46	39	35	30	70	59	48	41	37	31	73	63	53	45	40	35						
	1100	519	0.25	62	52	43	34	28	23	-	56	46	37	31	25	-	63	50	40	34	29	22	66	55	44	37	32	26	68	57	47	39	35	29	71	61	51	44	39	34						
	825	389	0.15	37	-	39	29	-	-	-	53	42	33	27	-	-	59	48	38	32	25	-	63	53	43	36	30	24	64	55	45	38	33	27	65	58	49	41	36	32						
	550	260	0.07	17	-	-	-	-	-	-	50	39	30	23	-	-	56	46	37	30	23	-	57	49	40	32	27	23	58	51	42	34	29	25	60	55	47	40	35	32						
	275	130	0.02	5	-	-	-	-	-	-	-	39	30	23	-	-	-	39	30	23	-	-	54	42	33	27	23	23	49	43	35	30	26	25	54	46	38	33	31	30						
12	2000	944	0.37	92	60	50	44	35	34	29	60	49	44	35	34	29	69	58	50	41	38	34	69	59	52	45	43	40	71	60	51	43	39	36	74	64	55	47	43	40						
	1600	755	0.24	60	54	47	42	37	39	33	57	50	45	41	46	40	64	53	46	41	43	38	67	57	48	41	40	35	69	59	50	42	38	35	70	62	53	45	42	39						
	1200	566	0.14	35	48	37	31	21	-	-	55	45	36	29	27	24	61	50	42	34	30	27	63	54	45	37	33	31	64	56	47	39	35	33	66	59	51	43	40	38						
	800	378	0.06	15	-	-	-	-	-	-	51	41	32	24	-	-	56	47	38	30	25	22	58	50	42	34	31	29	58	52	44	36	33	32	60	54	47	40	38	38						
	400	189	0.02	5	-	-	-	-	-	-	-	35	26	-	-	-	49	39	32	27	26	25	52	41	35	31	32	31	50	42	35	33	34	35	52	44	38	36	38	39						
14	2700	1274	0.54	134	65	57	53	42	35	31	* * * * *	67	58	50	41	35	32	69	60	51	43	37	34	71	62	52	44	39	35	73	65															

Performance Data • AHRI Certification and Performance Notes

30X Series • Basic Unit

Fiberglass Liner

Inlet Size	Airflow		Min. Inlet Δ Ps		Discharge Sound Power Levels @ 1.5" w.g. (375 Pa) Δ Ps							Radiated Sound Power Levels @ 1.5" w.g. (375 Pa) Δ Ps						
					Octave Band							Octave Band						
	cfm	l/s	"w.g.	Pa	2	3	4	5	6	7	2	3	4	5	6	7		
4	150	71	0.37	92	60	57	50	50	44	41	54	45	37	31	23	19		
5	250	118	0.35	87	67	62	55	52	47	43	58	49	39	34	27	21		
6	400	189	0.30	75	71	64	56	51	48	45	62	52	41	34	28	22		
7	550	260	0.35	87	72	62	54	54	50	49	64	52	44	40	32	27		
8	700	330	0.27	67	74	63	55	52	51	50	65	53	43	36	32	27		
9	900	425	0.27	67	74	64	57	55	52	49	64	54	48	40	32	36		
10	1100	519	0.25	62	76	65	58	54	53	51	66	55	44	37	32	26		
12	1600	755	0.24	60	75	66	60	58	56	54	67	57	48	41	40	35		
14	2100	991	0.33	82	80	69	61	59	57	54	67	57	48	40	34	29		
16	2800	1321	0.31	77	76	67	64	60	59	56	68	57	49	41	36	31		
24 x 16	5350	2525	0.45	112	83	74	69	67	66	64	72	64	57	47	44	44		

Performance Notes for Sound Power Levels:

- Discharge sound power is the noise emitted from the unit discharge into the downstream duct. The effect of including the energy correction to the discharge SWL, is higher sound power levels when compared to previous AHRI certified data. For more information on duct end reflection calculations see AHRI Standard 880.
- Radiated sound power is the breakout noise transmitted through the unit casing walls.
- Sound power levels are in decibels, dB re 10^{-12} watts.
- All sound data listed by octave bands is raw data without any corrections for room absorption or duct attenuation. Dash (-) in space indicates sound power level is less than 20 dB or equal to background.
- Minimum inlet Δ Ps is the minimum operating pressure requirement of the unit (damper full open) and the difference in static pressure from inlet to discharge of the unit.
- Asterisk (*) in space indicates that the minimum inlet static pressure requirement is greater than 0.5" w.g. (125 Pa) at rated airflow.
- Data derived from independent tests conducted in accordance with ANSI/ASHRAE Standard 130.

SINGLE DUCT EXHAUST TERMINAL UNITS

30HQX SERIES

- HOSPITAL GRADE
- DISSIPATIVE SILENCER

Model:

30HQX Hospital Grade with Dissipative Silencer

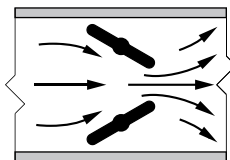

Inclined opposed blade damper configuration minimizes noisy turbulence and provides smooth, accurate, near linear flow control.



Model 30HQX

The 30HQX Hospital Grade exhaust terminal unit has been purposely designed to provide optimum performance, while addressing the needs of hospital and other critical environment applications where Indoor Air Quality (IAQ) is a concern. Standard features, like the access door and removable flow sensor ensures that maintenance is simplified. The standard fully insulated dissipative silencer is designed to minimize undue pressure loss while maximizing attenuation.

STANDARD FEATURES:

- Venturi valve inlet for reduced pressure drop.
- 22 ga. (0.86) zinc coated steel casing, mechanically sealed, low leakage construction.
- 16 ga. (1.63) corrosion-resistant steel inclined opposed blade damper with extruded PVC seals. 45° rotation, CW to close. Tight shut-off. Damper leakage is less than 2% of the terminal rated airflow at 3" w.g. (746 Pa).
- 1/2" (13) dia. plated steel drive shaft. An indicator mark on the end of the shaft shows damper position.
- Multi-point averaging Diamond Flow Sensor. Aluminum construction, supplied with balancing tees.
- FMI Diamond Flow Sensor is insert type design to permit easy removal for cleaning. Secured with thumb screws.
- Side access door allows quick access to flow sensor.
- Rectangular inlet and discharge with slip and drive cleat duct connection.
- Full NEMA 1 type controls enclosure for factory mounted controls.
- VAV section lined with 13/16" (21) thick, 4 lb. density Steri-Liner insulation. Fiberglass with a reinforced aluminum FSK (Foil-Scrim-Kraft) facing. Meets the requirements of NFPA 90A, UL 181 and ASTM C655.
- Right-hand controls location is standard (shown) when looking in direction of airflow. Optional left hand controls mounting is available. Unit is flippable.
- Available in 11 unit sizes to handle from 30 to 8575 cfm (14-4047 l/s).

Silencer Section:

- Designed to mate with VAV section for optimum performance and quiet operation.
- Optimized internal baffle geometry reduces self-generated noise, minimizes pressure drop and maximizes acoustic attenuation.
- 22 ga. (.86) coated steel perforated baffles encapsulate fiberglass acoustic media. Mylar lining with acoustical spacer isolates material from airstream.
- Internal Steri-Liner insulation on top and bottom optimizes sound reduction and eliminates need for external field applied thermal duct wrap.

Options and Accessories:

- Solid metal liner (VAV section).
- 24 VAC control transformer.
- Toggle Disconnect switch.
- Hanger brackets.
- Controls enclosure for field or factory mounted controls.
- Dust tight enclosure seal.
- 20 ga. (1.00) construction.
- Seismic Certification.



Intertek



Dimensions

Model 30HQX • Hospital Grade • Dissipative Silencer

Digital and Analog Electronic Controls

- A NEMA 1 control enclosure is included for factory mounted controls. Optional for field mounted controls.

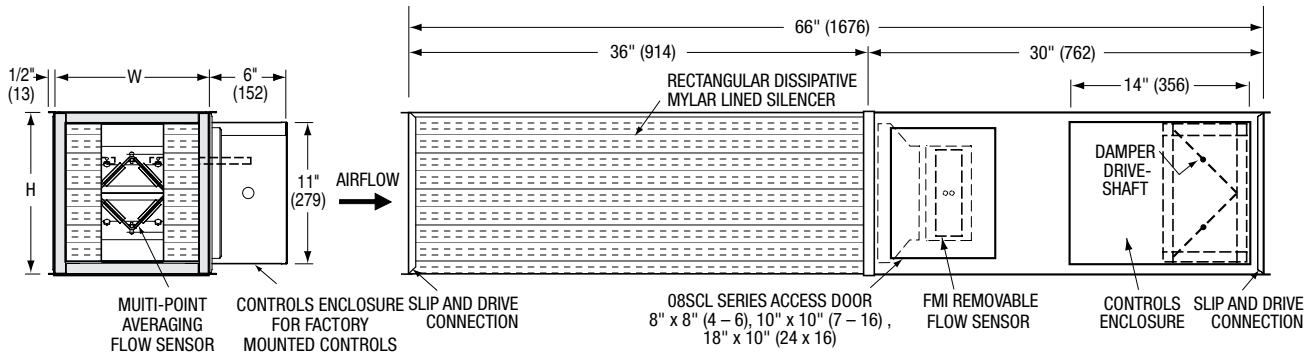

Dimensional Data

Unit Size	W	H
4	10 (254)	10 (254)
5	10 (254)	10 (254)
6	10 (254)	10 (254)
7	12 (305)	12 1/2 (318)
8	12 (305)	12 1/2 (318)
9	14 (356)	12 1/2 (318)
10	14 (356)	12 1/2 (318)
12	18 (457)	12 1/2 (318)
14	24 (610)	12 1/2 (318)
16	28 (711)	12 1/2 (318)
24 x 16	38 (965)	18 (457)

(FMI) Removable Flow Sensor

The (FMI) Removable Flow Sensor is a multi-point averaging airflow sensor. Designed to provide accurate sensing by sampling air velocities in four quadrants of a duct, the differential pressure flow sensor provides an averaged reading at an amplification of approximately 2.5 times the velocity pressure, dependent upon nominal size.

FEATURES:

- Removable for cleaning.
- All metal construction - no combustible materials in the air stream.
- Amplifies velocity pressure approximately 2.5 times to give a wide range of useful output signal vs. flow.
- Compact size allows for easy removal in tight spaces.
- Sensor design minimizes pressure drop and regenerated noise.
- Label provided on each unit gives airflow direction.
- Multi-point sensing gives an accurate output signal with a maximum deviation of only $\pm 5\%$ with a hard 90 degree elbow, provided a straight inlet condition with a minimum length of two equivalent duct diameters is provided.

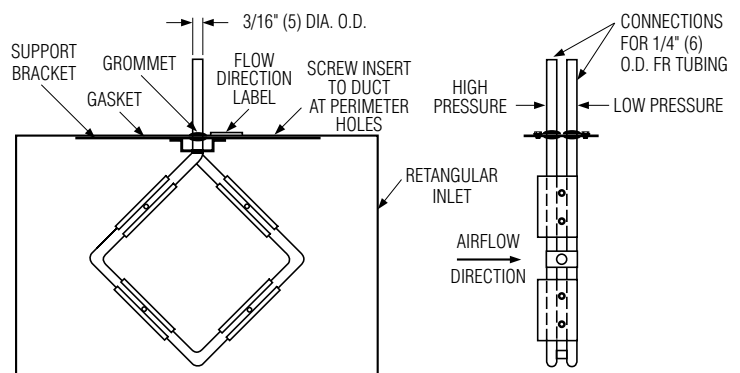

Recommended Airflow Ranges For Model 30HQX Single Duct Hospital Grade Exhaust Terminal Units

The recommended airflow ranges below are for 30HQX Series exhaust single duct terminal units with pressure independent controls and are presented as ranges for total and controller specific minimum and maximum airflow. Airflow ranges are based upon maintaining reasonable sound levels and controller limits using Nailor's Diamond Flow Sensor as the airflow measuring device. For a given unit size, the minimum, auxiliary minimum (where applicable) and the maximum flow setting must be within the range limits to ensure pressure independent operation, accuracy and repeatability.

Minimum airflow limits are based upon .02" w.g. (5 Pa) differential pressure signal from Diamond Flow Sensor on analog/ digital controls and .03" (7.5) for pneumatic controllers. This is a realistic low limit for many transducers used in the digital controls industry. Check your controls supplier for minimum limits. Setting airflow minimums lower, may cause damper hunting and result in a failure to meet minimum ventilation requirements. Factory settings will therefore not be made outside these ranges; however, a minimum setting of zero (shut-off) is an available option on pneumatic units. Where an auxiliary setting is specified, the value must be greater than the minimum setting.

The high end of the tabulated Total Airflow Range on pneumatic and analog electronic controls represents the Diamond Flow Sensor's differential pressure reading at 1" w.g. (249 Pa). The high end airflow range for digital controls is represented by the indicated transducer differential pressure.



Model 30HQX

ASHRAE 130 "Performance Rating of Air Terminals" is the method of test for the certification program. The "standard rating condition" (certification rating point) airflow volumes for each terminal unit size are tabulated below per AHRI Standard 880. These air volumes equate to an approximate inlet velocity of 2000 fpm (10.2 m/s).

When digital or other controls are mounted by Nailor, but supplied by others, these values are guidelines only, based upon experience with the majority of controls currently available. Controls supplied by others for factory mounting are configured and calibrated in the field. Airflow settings on pneumatic and analog controls supplied by Nailor are factory preset when provided.

Imperial Units, Cubic Feet per Minute

Unit Size	Inlet Type	Total Airflow Range, cfm	Airflow at 2000 fpm Inlet Velocity (nom.), cfm	Range of Minimum and Maximum Settings, cfm							
				Pneumatic 3000 Controller		Analog Electronic Controls		Digital Controls			
				Transducer Differential Pressure ("w.g.)							
				Min.	Max.	Min.	Max.	Min.	Max.		
								1.0	1.25	1.5	
4	Rect.	0 – 260	150	35	210	30	210	30	210	235	260
5		0 – 425	250	60	345	50	345	50	345	385	425
6		0 – 710	400	100	580	80	580	80	580	650	710
7		0 – 835	550	120	680	95	680	95	680	760	835
8		0 – 1190	700	170	970	140	970	140	970	1085	1190
9		0 – 1480	900	210	1210	170	1210	170	1210	1350	1480
10		0 – 1885	1100	265	1540	220	1540	220	1540	1720	1885
12		0 – 2780	1600	395	2270	320	2270	320	2270	2540	2780
14		0 – 3085	2100	435	2520	360	2520	360	2520	2820	3085
16		0 – 4385	2800	620	3580	505	3580	505	3580	4000	4385
24 x 16		0 – 8575	5350	1215	7000	990	7000	990	7000	7825	8575

Metric Units, Liters per Second

Unit Size	Inlet Type	Total Airflow Range, l/s	Airflow at 10.2 m/s Inlet Velocity (nom.), l/s	Range of Minimum and Maximum Settings, l/s							
				Pneumatic 3000 Controller		Analog Electronic Controls		Digital Controls			
				Transducer Differential Pressure (Pa)							
				Min.	Max.	Min.	Max.	Min.	Max.		
								249	311	374	
4	Rect.	0 – 123	71	17	99	14	99	14	99	111	123
5		0 – 201	118	28	163	24	163	24	163	182	201
6		0 – 335	189	47	274	38	274	38	274	307	335
7		0 – 394	260	57	321	45	321	45	321	359	394
8		0 – 562	330	80	458	66	458	66	458	512	562
9		0 – 698	425	99	571	80	571	80	571	637	698
10		0 – 890	519	125	727	104	727	104	727	812	890
12		0 – 1312	755	186	1071	151	1071	151	1071	1199	1312
14		0 – 1456	991	205	1189	170	1189	170	1189	1331	1456
16		0 – 2069	1321	293	1689	238	1689	238	1689	1888	2069
24 x 16		0 – 4047	2525	573	3303	467	3303	467	3303	3693	4047

A SINGLE DUCT TERMINAL UNITS

Performance Data • NC Level Application Guide

30HQX Series • Hospital Grade • Dissipative Silencer

Terminal: Steri-Liner • Silencer: Mylar, Spacer, Steri-Liner (MSSL) Media

Inlet Size	Airflow cfm l/s		Min. inlet ΔPs "w.g. Pa		NC Levels @ Inlet Pressure (ΔPs) shown											
					DISCHARGE					RADIATED						
					Min. ΔPs	0.5" w.g. (125 Pa)	1.0" w.g. (250 Pa)	1.5" w.g. (375 Pa)	2.0" w.g. (500 Pa)	3.0" w.g. (750 Pa)	Min. ΔPs	0.5" w.g. (125 Pa)	1.0" w.g. (250 Pa)	1.5" w.g. (375 Pa)	2.0" w.g. (500 Pa)	3.0" w.g. (750 Pa)
4	200	94	0.63	157	-	*	-	-	-	-	-	*	-	21	24	28
	150	71	0.37	92	-	-	-	-	-	-	-	-	-	21	22	22
	100	47	0.17	42	-	-	-	-	-	-	-	-	-	-	20	23
	75	35	0.10	25	-	-	-	-	-	-	-	-	-	-	-	-
	50	24	0.05	12	-	-	-	-	-	-	-	-	-	23	25	30
5	300	142	0.60	149	-	*	-	20	23	23	-	*	-	-	22	25
	250	118	0.40	99	-	-	-	-	-	-	-	-	-	-	-	20
	200	94	0.24	60	-	-	-	-	-	-	-	-	-	-	-	-
	125	59	0.10	25	-	-	-	-	-	-	-	-	20	23	26	30
	100	47	0.06	15	-	-	-	-	-	-	-	-	-	21	25	29
6	450	212	0.49	122	-	-	-	-	-	20	-	-	-	20	21	25
	400	189	0.39	97	-	-	-	-	-	-	-	-	-	-	-	20
	300	142	0.22	55	-	-	-	-	-	-	22	-	21	26	30	35
	200	94	0.10	25	-	-	-	-	-	-	-	-	-	24	28	32
	100	47	0.03	7	-	-	-	-	-	-	-	-	-	20	23	26
7	650	307	0.50	124	-	-	-	21	25	28	-	-	-	-	-	20
	550	260	0.36	89	-	-	-	21	23	25	-	20	25	29	31	35
	335	158	0.14	35	-	-	-	-	-	-	-	-	23	26	29	33
	225	106	0.06	15	-	-	-	-	-	-	-	-	21	24	26	31
	110	52	0.02	5	-	-	-	-	-	-	-	-	-	21	23	26
8	800	378	0.36	89	-	-	-	23	25	29	20	20	23	28	34	38
	700	330	0.28	70	-	-	-	21	24	25	-	-	21	25	31	35
	600	283	0.20	50	-	-	-	23	24	25	-	-	-	23	28	31
	400	189	0.09	22	-	-	-	-	-	-	-	-	-	20	23	26
	175	83	0.02	5	-	-	-	-	-	-	-	20	24	28	30	35
9	1050	495	0.43	107	-	-	-	23	25	29	-	-	21	24	25	31
	900	425	0.32	80	-	-	-	20	24	25	-	-	-	-	21	24
	675	319	0.18	45	-	-	-	-	21	21	-	-	-	-	-	-
	450	212	0.08	20	-	-	-	-	-	-	29	28	31	34	35	40
	225	106	0.02	5	-	-	-	-	-	-	22	25	29	31	33	38
10	1350	637	0.49	122	-	-	-	24	26	30	-	20	25	28	30	35
	1100	519	0.32	80	-	-	-	23	24	26	-	-	20	24	26	30
	825	389	0.18	45	-	-	-	-	-	21	24	25	30	34	37	40
	550	260	0.08	20	-	-	-	-	-	-	-	21	26	31	34	37
	275	130	0.02	5	-	-	-	-	-	-	-	-	24	28	30	34
12	2000	944	0.53	132	-	*	20	25	29	31	-	*	-	21	25	26
	1600	755	0.34	85	-	-	-	23	25	28	30	30	33	37	40	44
	1200	566	0.19	47	-	-	-	20	20	23	23	24	29	34	36	40
	800	378	0.08	20	-	-	-	-	-	-	-	-	24	29	31	35
	400	189	0.02	5	-	-	-	-	-	-	-	-	-	-	-	21
14	2700	1274	0.55	137	-	*	25	29	31	34	-	*	-	-	-	-
	2100	991	0.33	82	-	-	20	24	26	26	44	43	48	50	53	56
	1550	731	0.18	45	-	-	-	-	-	-	40	41	47	49	51	55
	1050	495	0.09	22	-	-	-	-	-	-	32	38	44	46	48	51
	525	248	0.02	5	-	-	-	-	-	-	31	37	43	45	47	50
16	3500	1652	0.50	124	-	-	24	29	30	34	24	35	39	43	45	47
	2800	1321	0.31	77	-	-	21	26	29	31	21	23	29	33	34	36
	2100	991	0.18	45	-	-	-	21	23	24	-	-	23	26	29	31
	1400	661	0.08	20	-	-	-	-	-	-	-	-	-	20	21	23
	700	330	0.02	5	-	-	-	-	-	-	-	-	-	-	-	-
24	5350	2525	0.49	122	21	21	24	28	30	33	40	40	36	38	40	43
	5000	2360	0.43	107	20	21	23	28	29	31	39	39	35	36	39	41
16	4000	1888	0.27	67	-	-	21	26	28	29	30	30	31	34	35	36
	3000	1416	0.16	40	-	-	-	21	24	25	20	21	25	30	31	33
16	2000	944	0.07	17	-	-	-	-	-	21	-	-	21	24	26	29

Performance Notes:

1. NC Levels are calculated based on procedures as outlined on page A101.
2. Dash (-) in space indicates a NC less than 20.
3. Asterisk (*) in space indicates that the minimum inlet static pressure requirement is greater than 0.5" w.g. (125 Pa) at rated airflow.

Performance Data • Discharge Sound Power Levels

30HQX Series • Hospital Grade • Dissipative Silencer

Terminal: Steri-Liner • Silencer: Mylar, Spacer, Steri-Liner (MSSL) Media

SINGLE DUCT TERMINAL UNITS

Inlet Size	Airflow		Min. inlet ΔPs		Sound Power Octave Bands @ Inlet Pressure (ΔPs) shown																																									
					Minimum ΔPs							0.5" w.g. (125Pa) ΔPs							1.0" w.g. (250Pa) ΔPs							1.5" w.g. (375Pa) ΔPs							2.0" w.g. (500Pa) ΔPs							3.0" w.g. (750Pa) ΔPs						
					2	3	4	5	6	7	2	3	4	5	6	7	2	3	4	5	6	7	2	3	4	5	6	7	2	3	4	5	6	7	2	3	4	5	6	7						
4	200	94	0.63	157	57	53	40	30	-	-	*	*	*	*	*	*	59	53	40	31	-	-	61	54	40	32	20	26	61	55	41	34	-	26	62	55	42	37	-	28						
	150	71	0.37	92	-	47	34	24	-	-	-	48	35	24	-	-	57	49	35	26	-	-	57	51	36	29	20	20	56	51	37	31	-	21	58	51	38	33	-	25						
	100	47	0.17	42	-	41	27	16	-	-	-	41	27	-	-	-	44	30	24	-	-	-	44	32	27	-	-	-	44	33	28	-	22	-	45	33	29	-	25							
	75	35	0.10	25	-	41	26	-	-	-	-	39	25	-	-	-	41	28	22	-	-	-	40	28	23	-	-	-	40	28	24	-	-	-	40	27	24	-	24							
	50	24	0.05	12	-	-	-	-	-	-	-	-	-	-	-	-	-	-	-	-	-	-	-	-	-	-	-	-	-	21	-	-	-	-	-	22	-	23								
5	300	142	0.60	149	58	54	43	35	26	25	*	*	*	*	*	*	61	55	44	36	27	26	64	57	44	36	27	26	66	59	45	37	27	27	66	60	46	38	28	30						
	250	118	0.40	99	-	50	39	29	-	-	56	51	39	30	-	-	60	53	40	30	-	-	62	55	41	32	20	20	62	56	42	33	-	21	63	56	43	36	20	26						
	200	94	0.24	60	-	47	35	23	-	-	-	47	35	25	-	-	59	51	36	27	-	-	59	52	38	29	-	-	58	52	38	30	-	20	60	53	39	34	-	25						
	125	59	0.10	25	-	39	26	-	-	-	-	42	27	-	-	-	55	45	30	23	-	-	-	45	31	25	-	-	-	45	32	26	-	-	-	55	46	34	30	-	27					
	100	47	0.06	15	-	-	-	-	-	-	-	-	39	23	-	-	-	42	27	20	-	-	-	43	28	23	-	-	-	42	28	24	-	20	-	46	29	25	-	25						
6	450	212	0.49	122	-	49	43	43	39	33	-	49	43	43	39	33	61	51	43	43	39	33	64	54	44	43	39	33	66	57	45	43	39	33	67	59	48	43	40	34						
	400	189	0.39	97	-	47	41	40	34	29	-	47	41	39	33	27	61	50	41	40	34	28	63	53	43	40	35	29	65	56	44	40	35	29	66	57	47	41	35	31						
	300	142	0.22	55	-	42	35	30	20	-	-	44	36	30	24	-	59	48	36	29	-	-	59	52	39	31	21	-	61	53	41	32	22	22	62	54	44	34	22	25						
	200	94	0.10	25	-	-	-	-	-	-	-	42	27	-	-	-	-	45	32	-	-	-	-	47	36	22	-	-	-	48	37	25	-	20	-	48	38	28	-	24						
	100	47	0.03	7	-	-	-	-	-	-	-	-	-	-	-	-	-	39	26	-	-	-	-	40	27	-	-	-	-	27	-	-	-	-	-	41	29	22	-	25						
7	650	307	0.50	124	61	56	44	39	29	34	61	56	44	39	29	34	64	57	45	38	29	35	68	59	45	39	29	36	71	60	46	41	29	37	73	64	48	42	30	39						
	550	260	0.36	89	57	52	40	33	21	28	59	52	40	32	22	28	63	54	41	35	22	30	68	57	42	37	22	32	69	59	44	38	23	34	71	62	46	40	24	37						
	335	158	0.14	35	-	40	27	-	-	-	53	44	30	22	-	-	60	49	33	28	-	22	62	52	36	30	-	27	62	53	38	32	-	30	63	54	40	36	-	34						
	225	106	0.06	15	-	-	-	-	-	-	53	40	24	-	-	-	54	46	29	23	-	20	55	48	32	27	-	26	54	48	33	29	-	29	55	48	35	31	-	34						
	110	52	0.02	5	-	-	-	-	-	-	-	35	-	-	-	-	-	36	21	20	-	-	-	-	23	22	-	23	-	39	24	22	-	28	-	38	26	23	-	34						
8	800	378	0.36	89	59	52	42	40	34	30	62	53	42	40	35	31	68	57	43	40	35	34	71	60	45	41	35	36	73	62	46	41	35	38	76	66	49	42	34	40						
	700	330	0.28	70	-	49	40	36	29	25	61	52	40	36	29	25	67	55	41	37	29	31	70	58	43	38	30	34	72	62	44	39	30	35	73	64	48	40	30	39						
	600	283	0.20	50	-	46	38	33	25	21	59	49	38	33	24	21	65	54	40	34	24	29	69	57	42	36	25	32	70	60	43	36	24	34	71	63	46	39	26	37						
	400	189	0.09	22	-	39	28	-	-	-	55	44	31	25	-	-	61	51	34	29	-	24	63	54	37	31	-	28	64	55	40	34	-	31	63	57	43	39	20	35						
	175	83	0.02	5	-	-	-	-	-	-	-	39	23	-	-	-	-	43	32	26	-	22	-	44	37	33	-	27	-	43	36	33	-	31	-	43	33	34	-	36						
9	1050	495	0.43	107	61	55	45	43	38	36	60	55	45	43	38	35	66	58	45	42	37	37	71	61	47	43	38	38	73	63	47	43	38	40	76	67	49	44	39	43						
	900	425	0.32	80	57	52	42	38	32	29	61	54	42	38	31	29	65	56	43	39	32	32	69	59	44	39	32	35	72	62	45	40	32	37	73	65	47	41	33	40						
	675	319	0.18	45	-	46	37	29	-	-	56	48	36	29	-	-	64	54	38	31	20	27	66	57	40	32	22	31	68	59	41	34	24	34	68	61	44	37	27	38						
	450	212	0.08	20	-	-	-	-	-	-	57	44	27	-	-	-	59	50	31	23	-	23	61	53	35	27	-	28	62	54	37	29	-	31	62	55	38	32	22	36						
	225	106	0.02	5	-	-	-	-	-	-	-	42	23	-	-	-	-	42	23	-	-	-	-	54	43	26	20	-	26	-	44	27	22	-	31	56	46	29	26	21	37					
10	1350	637	0.49	122	60	54	45	46	45	40	60	55	46	46	46	41	68	59	46	46	45	41	72	63	48	46	45	43	74	65	49	46	45	44	77	68	51	47	45	46						
	1100	519	0.32	80	-	48	42	42	37	32	60	53	42	42	37	32	66	57	43	42	37	34	71	61	45	42	38	38	72	63	47	43	37	40	74	66	49	43	38	44						
	825	389	0.18	45	-	41	36	34	25	-	56	48	37	34	26	22	64	54	39	34	26	31	67	58	42	35	27	34	68	60	44	36	27	37	70	62	47	38	29	41						
	550	260	0.08	20	-	-	27	-	-	-	-	44	30	20	-	20	59	51	34	24	-	26	62	54	38	27	-	31	61	55	39	27	-	33	62	56	41	31	22	38						
	275	130	0.02	5	-	-	-	-	-	-	-	-	-	-	-	-	-	43	27	-	-	21	55	45	31	21	-	28	-	44	30	22	-	33	56	46	32	24	23	40						
12	2000	944	0.53	132	62	55	47	47	48	44	*	*	*	*	*	*	69	61	49	48	49	46	73	64	50	48	49	47	76	66	51	48	48	48	78	69	54	48	49	50						
	1600	755	0.34	85	59	52	45	45	43	38	62	54	44	44	41	36	68	58	45	44	41	39	71	61	47	44	41	42	73	64	48	44	42	44	75	67	51	45	44	47						
	1200	566	0.19	47	53	45	39	37	30	24	60	50	40	38	31	28	65	55	41	38	32	35	69	59	44	39	34	39	69	61	45	39	36	41	71	64	49	41	39	46						
	800	378	0.08	20	-	37	31	23	-	-	56	45	32	25	-	23	61	52	36	27	24	31	64	55	39	30	28	35	64	56	41	31	30	37	65	57	43	34	34	41						
	400	189	0.02	5	-	-	-	-	-	-	-	40	22	-	-	-	52	44	28	20	21	26	56	46	32	24	26	31	54	46	32	27	29	35	57	47	35	30	33	42						
14	2700	1274	0.55	137	64	55	48	49	52	48	*	*	*	*	*	*	73	62	49	50	52	49	76	64	51	51	52	49	78	66	53	51	52	50	80	69	55	53	53	52						
	2100	991	0.33	82	57	49	43	44	43	37	65	54	43	45	44	38	69	58	45	46	44	40	72	61	48	47	44	43	74	63	50	47	45	45	74	65	52	49	47	48						

Performance Data • Radiated Sound Power Levels

30HQX Series • Hospital Grade • Dissipative Silencer

Terminal: Steri-Liner • Silencer: Mylar, Spacer, Steri-Liner (MSSL) Media

Inlet Size	Airflow		Min. inlet ΔPs		Sound Power Octave Bands @ Inlet Pressure (ΔPs) shown																																									
					Minimum ΔPs							0.5" w.g. (125Pa) ΔPs							1.0" w.g. (250Pa) ΔPs							1.5" w.g. (375Pa) ΔPs							2.0" w.g. (500Pa) ΔPs							3.0" w.g. (750Pa) ΔPs						
					2	3	4	5	6	7	2	3	4	5	6	7	2	3	4	5	6	7	2	3	4	5	6	7	2	3	4	5	6	7	2	3	4	5	6	7						
4	200	94	0.63	157	52	42	33	27	27	21	*	*	*	*	*	*	55	43	34	28	27	22	59	49	39	33	28	23	59	50	41	36	29	25	58	50	44	39	32	28						
	150	71	0.37	92	48	35	27	-	-	-	49	36	27	-	-	-	54	43	33	27	21	-	54	45	37	31	23	19	54	45	39	33	26	22	52	44	40	36	29	26						
	100	47	0.17	42	-	-	-	-	-	-	47	35	24	-	-	-	47	38	30	24	-	-	49	39	33	28	-	-	49	38	33	29	23	21	48	38	34	32	29	26						
	75	35	0.10	25	-	-	-	-	-	-	-	31	23	-	-	-	-	32	27	21	-	-	-	33	27	25	-	-	-	32	28	26	23	21	47	36	32	31	29	26						
	50	24	0.05	12	-	-	-	-	-	-	-	-	-	-	-	-	-	-	-	-	-	-	-	-	24	23	-	-	-	31	26	25	23	-	47	36	31	30	28	25						
5	300	142	0.60	149	51	42	35	27	25	20	*	*	*	*	*	*	55	45	37	31	26	21	60	50	40	35	29	23	62	52	42	37	32	26	62	53	47	41	37	31						
	250	118	0.40	99	-	39	31	23	-	-	-	39	32	26	-	-	55	44	35	30	22	-	58	49	39	34	27	21	59	50	42	36	30	24	59	51	45	40	35	30						
	200	94	0.24	60	-	-	-	-	-	-	-	37	29	21	-	-	53	44	34	29	-	-	55	46	38	33	25	-	54	47	40	35	29	24	53	47	42	38	33	29						
	125	59	0.10	25	-	-	-	-	-	-	-	-	-	-	-	-	-	39	33	27	-	-	-	40	35	30	23	-	-	39	36	31	27	23	-	40	36	34	32	29	26					
	100	47	0.06	15	-	-	-	-	-	-	-	-	-	-	-	-	-	36	30	24	-	-	-	36	32	27	23	-	-	35	32	29	27	23	-	37	33	32	32	28	25					
6	450	212	0.49	122	53	43	35	28	25	-	54	44	35	28	25	-	61	49	39	31	28	22	64	54	42	35	30	24	65	57	46	38	33	27	65	58	51	42	37	31						
	400	189	0.39	97	51	40	33	24	-	-	54	42	33	26	21	-	60	47	36	30	24	-	62	52	41	34	28	22	63	55	44	36	31	25	63	57	49	41	35	30						
	300	142	0.22	55	-	34	25	-	-	-	51	38	29	22	-	-	56	46	35	28	21	-	59	50	40	33	26	-	58	51	42	35	29	22	58	51	46	40	34	28						
	200	94	0.10	25	-	-	-	-	-	-	49	36	27	21	-	-	52	44	34	27	-	-	53	46	39	31	24	-	51	47	40	33	27	22	50	46	42	37	31	26						
	100	47	0.03	7	-	-	-	-	-	-	-	34	23	-	-	-	-	28	23	-	-	-	-	36	30	26	21	-	-	34	32	28	24	21	-	37	33	31	28	26	23					
7	650	307	0.50	124	56	50	42	33	27	25	56	50	42	33	27	25	59	52	42	35	30	27	64	54	46	41	34	29	67	56	47	44	36	31	69	59	50	47	39	34						
	550	260	0.36	89	53	46	38	28	24	-	54	43	34	26	25	-	59	49	41	35	29	23	64	52	44	40	32	27	66	54	45	42	34	29	67	57	48	45	37	32						
	335	158	0.14	35	-	-	-	-	-	-	-	37	31	26	-	-	55	44	35	31	22	-	58	48	38	34	27	21	58	49	40	35	29	25	58	50	43	38	33	30						
	225	106	0.06	15	-	-	-	-	-	-	-	-	26	21	-	-	51	41	32	26	-	-	51	44	36	30	25	21	52	43	37	32	28	25	50	43	39	36	32	31						
	110	52	0.02	5	-	-	-	-	-	-	-	-	-	-	-	-	-	25	23	-	-	-	-	-	28	27	25	22	-	-	30	28	28	25	-	39	34	33	31	30	27					
8	800	378	0.36	89	57	47	41	32	26	20	59	48	40	31	26	21	63	53	45	37	31	27	66	55	45	38	33	29	68	57	47	39	35	31	70	60	50	42	38	36						
	700	330	0.28	70	53	44	38	29	22	-	57	46	37	28	23	-	62	50	41	34	29	25	65	53	43	36	32	27	67	56	45	38	33	29	68	58	49	41	37	34						
	600	283	0.20	50	40	34	26	-	-	-	54	43	35	27	-	-	61	48	39	32	26	21	64	52	42	35	30	26	65	55	44	37	32	28	65	57	48	40	36	33						
	400	189	0.09	22	51	38	30	22	-	-	50	38	31	25	-	-	56	45	36	30	22	-	58	49	39	33	27	22	58	50	42	35	30	25	58	51	44	38	34	31						
	175	83	0.02	5	-	-	-	-	-	-	-	50	40	30	25	-	-	-	36	31	27	23	-	-	37	33	30	26	23	-	38	34	31	30	27	49	42	36	34	33	31					
9	1050	495	0.43	107	59	50	44	34	30	28	59	49	43	34	31	28	63	53	45	36	32	28	66	56	49	41	36	32	68	58	52	44	36	32	70	61	56	48	40	35						
	900	425	0.32	80	54	46	40	30	25	21	57	47	39	31	26	21	61	51	44	35	29	22	64	54	48	40	32	26	66	56	51	43	35	29	68	60	54	47	40	34						
	675	319	0.18	45	-	40	33	23	-	-	54	44	36	28	21	-	58	49	42	34	26	-	61	52	47	39	31	24	63	54	49	42	34	28	64	56	52	45	37	32						
	450	212	0.08	20	-	-	-	-	-	-	52	39	33	26	-	-	54	45	41	33	24	-	56	48	43	36	28	22	57	50	44	38	30	25	57	51	46	41	34	30						
	225	106	0.02	5	-	-	-	-	-	-	-	-	-	-	-	-	50	38	31	27	-	-	51	39	34	31	25	21	50	40	36	33	28	24	50	42	39	36	31	29						
10	1350	637	0.49	122	56	48	40	34	32	25	56	49	40	33	32	25	63	53	43	37	34	27	67	56	46	39	35	30	70	59	48	41	37	31	73	63	53	45	40	35						
	1100	519	0.32	80	52	43	34	28	23	-	56	46	37	31	25	-	63	50	40	34	29	22	66	55	44	37	32	26	68	57	47	39	35	29	71	61	51	44	39	34						
	825	389	0.18	45	-	39	29	-	-	-	53	42	33	27	-	-	59	48	38	32	25	-	63	53	43	36	30	24	64	55	45	38	33	27	65	58	49	41	36	32						
	550	260	0.08	20	-	-	-	-	-	-	50	39	30	23	-	-	56	46	37	30	23	-	57	49	40	32	27	23	58	51	42	34	29	25	60	55	47	40	35	32						
	275	130	0.02	5	-	-	-	-	-	-	-	-	-	-	-	-	-	39	30	23	-	-	-	54	42	33	27	23	54	42	33	27	23	23	49	43	35	30	26	25						
12	2000	944	0.53	132	60	50	44	35	34	29	*	*	*	*	*	*	69	58	50	41	38	34	69	59	52	45	43	40	71	60	51	43	39	36	74	64	55	47	43	40						
	1600	755	0.34	85	54	47	42	37	39	33	57	50	45	41	46	40	64	53	46	41	43	38	67	57	48	41	40	35	69	59	50	42	38	35	70	62	53	45	42	39						
	1200	566	0.19	47	48	37	31	21	-	-	55	45	36	29	27	24	61	50	42	34	30	27	63	54	45	37	33	31	64	56	47	39	35	33	66	59	51	43	40	38						
	800	378	0.08	20	-	-	-	-	-	-	51	41	32	24	-	-	56	47	38	30	25	22	58	50	42	34	31	29	58	52	44	36	33	32	60	54	47	40	38	38						
	400	189	0.02	5	-	-	-	-	-	-	-	35	26	-	-	-	49	39	32	27	26	25	52	41	35	31	32	31	50	42	35	33	34	35	52	44	38	36	38	39						
14	2700	1274	0.55	137	65	57	53	42	35	31	*	*	*	*	*	*	67	58	50	41	35	32	69	60	51	43	37	34	71	62	52	44	39	35	73	65	55	48	42	38						
	2100	991	0.33	82	59	50	46	35	29	22	59	50	46	35	29	22	64	54	44	36	31	25	67	57	48	40	34	29	68	58	49	42	36</													

Performance Data • AHRI Certification and Performance Notes

30HQX Series • Hospital Grade • Dissipative Silencer

Terminal: Steri-Liner • Silencer: Mylar, Spacer, Steri-Liner (MSSL) Media

Inlet Size	Airflow		Min. Inlet ΔPs		Discharge Sound Power Levels @ 1.5" w.g. (375 Pa) ΔPs							Radiated Sound Power Levels @ 1.5" w.g. (375 Pa) ΔPs						
					Octave Band							Octave Band						
	cfm	l/s	"w.g.	Pa	2	3	4	5	6	7	2	3	4	5	6	7		
4	150	71	0.37	92	57	51	36	29	20	20	54	45	37	31	23	19		
5	250	118	0.40	99	62	55	41	32	20	20	58	49	39	34	27	21		
6	400	189	0.39	97	63	53	43	40	35	29	62	52	41	34	28	22		
7	550	260	0.36	89	68	57	42	37	22	32	64	52	44	40	32	27		
8	700	330	0.28	70	70	58	43	38	30	34	65	53	43	36	32	27		
9	900	425	0.32	80	69	59	44	39	32	35	64	54	48	40	32	36		
10	1100	519	0.32	80	71	61	45	42	38	38	66	55	44	37	32	26		
12	1600	755	0.34	85	71	61	47	44	41	42	67	57	48	41	40	35		
14	2100	991	0.33	82	72	61	48	47	44	43	67	57	48	40	34	29		
16	2800	1321	0.31	77	74	62	53	51	50	48	68	57	49	41	36	31		
24 x 16	5350	2525	0.49	122	75	69	59	57	56	56	72	64	57	47	44	44		

Performance Notes for Sound Power Levels:

- Discharge sound power is the noise emitted from the unit discharge into the downstream duct.
- Radiated sound power is the breakout noise transmitted through the unit casing walls.
- Sound power levels are in decibels, dB re 10⁻¹² watts.
- All sound data listed by octave bands is raw data without any corrections for room absorption or duct attenuation. Dash (-) in space indicates sound power level is less than 20 dB or equal to background.
- Minimum inlet ΔPs is the minimum operating pressure requirement of the unit (damper full open) and the difference in static pressure from inlet to discharge of the unit.
- Asterisk (*) in space indicates that the minimum inlet static pressure requirement is greater than 0.5" w.g. (125 Pa) at rated airflow.
- Data derived from independent tests conducted in accordance with ANSI/ASHRAE Standard 130.

A

SINGLE DUCT TERMINAL UNITS

3100 SERIES • VARIABLE OR CONSTANT VOLUME PRODUCT OVERVIEW



Nailor 3100 Series Single Duct Terminal units are simply put, versatile. Whether the requirement calls for a constant or variable air volume (VAV) single duct terminal, hot water reheat or requires basic attenuation, the 3100 Series terminal units deliver.

Available in numerous configurations, each 3100 Series is designed to control airflow in response to a control signal. The industry proven round butterfly damper utilizes a peripheral gasket for extremely tight shutoff. The series provides a round inlet for size 4-16.

The pressure independent 3100 Series terminal units operate in both constant and variable flow configurations. Unlike a constant volume system, which is sized for the peak demand of the entire building, a VAV system is sized for the instantaneous peak demand of all zones. Since VAV systems modulate airflow based on demand, operating costs are generally reduced compared to constant volume systems as less fan energy and refrigeration is needed.

Numerous options on the 3100 Series allow for application specific customization. Options range from different insulation types, reheat versions, attenuators, control sequences, low temperature and ultra low casing leakage construction to access doors. Controls options include digital, analog electric and pneumatic types suitable for most applications. Depending on the selected controls option, a full NEMA 1 type low voltage enclosure may be included. All pressure independent control options utilize the multi-point averaging Nailor Diamond Flow sensor to measure velocity pressure.



3101 Cooling or Heating Only



31RW Cooling with Hot Water Reheat

A

SINGLE DUCT TERMINAL UNITS

SINGLE DUCT VARIABLE OR CONSTANT AIR VOLUME

3100 SERIES

- Butterfly Damper
- Round Inlets



Model 3101

Models:

- 3101** Cooling or Heating only
- 31RW** Cooling with Hot Water Reheat

Variable Air Volume Systems supply a constant temperature to an area and vary the volume as opposed to a conventional HVAC system which supplies a constant volume and varies the air temperature.

Operating costs are greatly reduced compared to the larger conventional HVAC systems by using less fan and refrigeration energy. Variable Air Volume Systems also cut initial cost by taking advantage of building diversity. System capacity is determined by the instantaneous peak demand of all zones in lieu of the peak demand for the entire building.

The smaller components of a VAV system require less floor space and give the owner the flexibility to adapt to tenant changes as desired at any time during or after construction of the building.

With today's energy conservation and efficiency requirements, **Model Series 3100** terminals units are designed for and adaptable to any modern VAV requirements. Control components and options provide maximum flexibility with a wide scope for cost effective innovation.

STANDARD FEATURES:

- 22 ga. (0.86) galvanized steel casing, mechanically sealed, low leakage construction. Leakage is less than 1% of the terminal rated airflow at 1" w.g. (249 Pa).
- 2 x 20 ga. (1.00) round laminated butterfly damper with a polyurethane gasket. Damper leakage is less the 1% of the terminal rated airflow at 3" w.g. (750 pa.) and less than 2% at 6" w.g. (1500 pa.) as tested in accordance with ANSI / ASHRAE Standard 130.
- Self-lubricating Celcon® bearings.
- 1/2" (13) dia. plated steel drive shaft, with indicator mark on the end to show damper position.
- Available in 11 unit sizes to handle from 0 – 8300 cfm (0 – 3917 l/s).
- Unit sizes 4 – 16 feature round inlet collars.
- Unit size 24 x 16 features a rectangular inlet.
- Multi-point averaging Diamond Flow Sensor. Aluminum construction. Supplied with balancing tees for field calibration and balancing.
- Rectangular discharge with slip and drive cleat duct connection.
- Full NEMA 1 type low voltage enclosure for factory mounted controls.
- 3/4" (19) dual density fiberglass insulation maximizes acoustical and thermal performance. 4 lb. high density skin is treated to resist abrasion and erosion from airflow. Exposed edges are coated. Meets requirements of NFPA 90A and UL 181.
- Right-hand controls location is standard (shown) when looking in direction of airflow. Damper is CW to close. Optional left-hand controls location is available.
- Model D3101 can be installed horizontally, vertical or at any angle. Operation is not affected by position.
- Options:
 - Steri-Liner
 - Fiber-Free Liner
 - Solid metal liner
 - Removable Flow Sensor
 - 1" (25) Fiberglass liner
- Bottom access door
- 24 VAC Control transformer
- Toggle disconnect switch
- Hanger brackets
- Controls enclosure for field mounted controls
- Dust tight enclosure seal
- 20 ga. (1.00) construction
- Low temperature construction
- Ultra Low Leakage casing
- Bottom mount controls enclosure
- Seismic Certification
- Oversized casing.



Intertek



Dimensions

Model 3101 • Basic Unit with Controls

Digital and Analog Electronic Controls

- Full NEMA 1 controls enclosure is provided for factory mounted controls. Optional for field mounted controls.

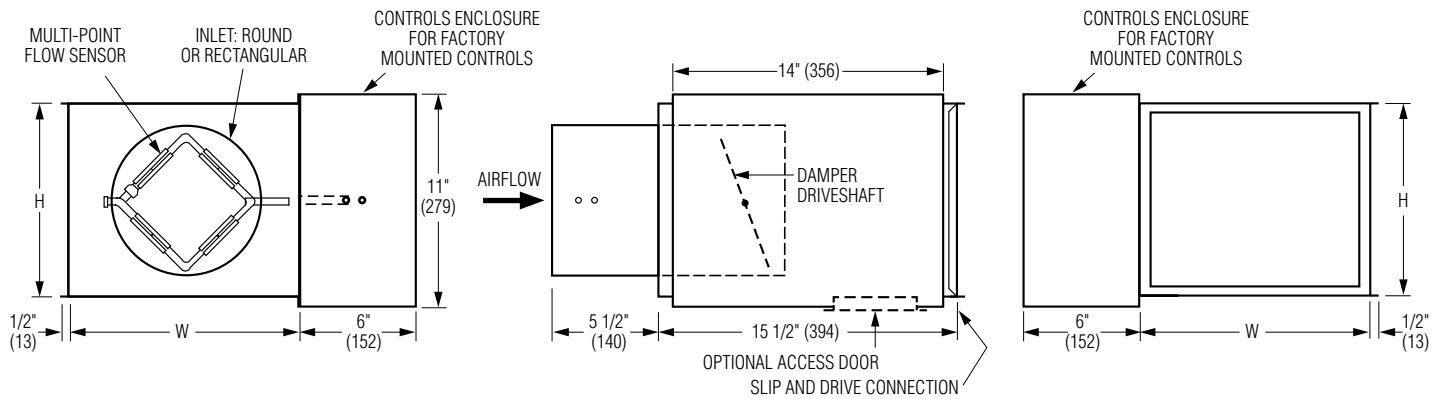

Digital and Analog Electronic Controls with Bottom Mount Control Enclosure

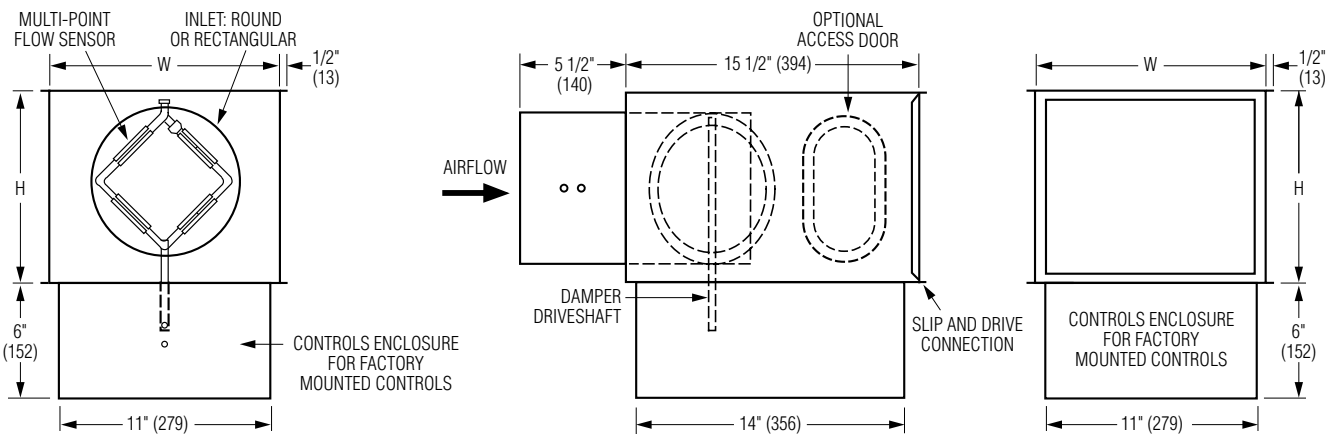

Pneumatic Controls

- Units are equipped with CSC-3011 universal reset controller. Direct or reverse acting, with the damper normally open or normally closed. Rotary actuator MCP-3631 is standard.

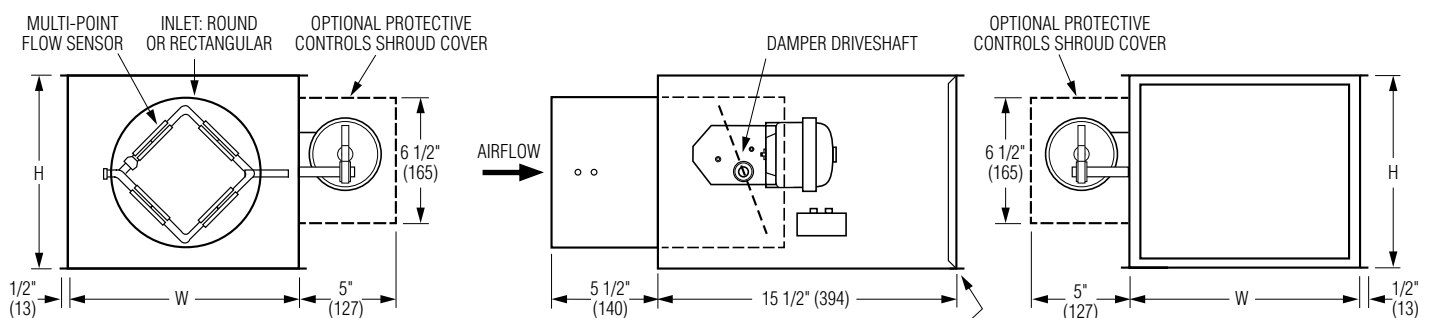

Dimensions

Model 3101 • Integral Sound Attenuator

Digital and Analog Electronic Controls

- Single continuous length terminal construction minimizes casing leakage.
- Continuous internal insulation reduces insulation seams and minimizes airflow disturbance.
- Supplied with same liner as basic unit.

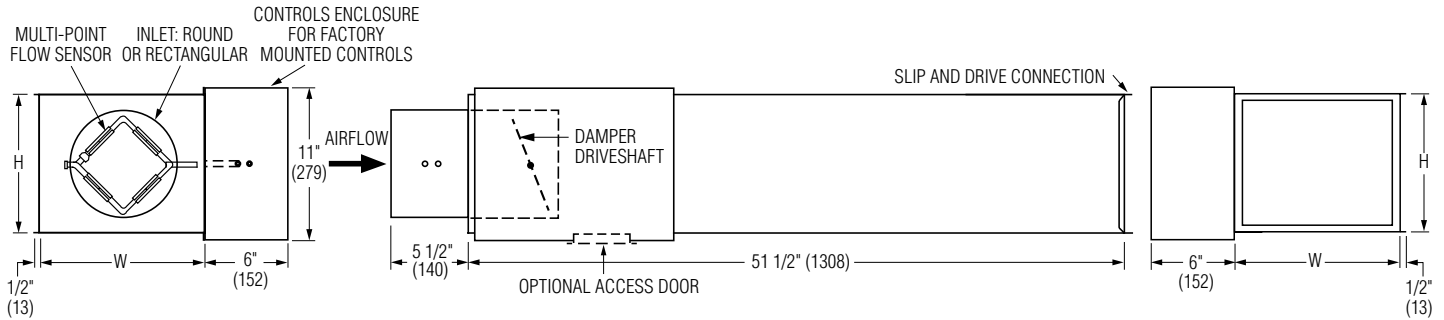

Digital and Analog Electronic Controls with Bottom Mount Control Enclosure

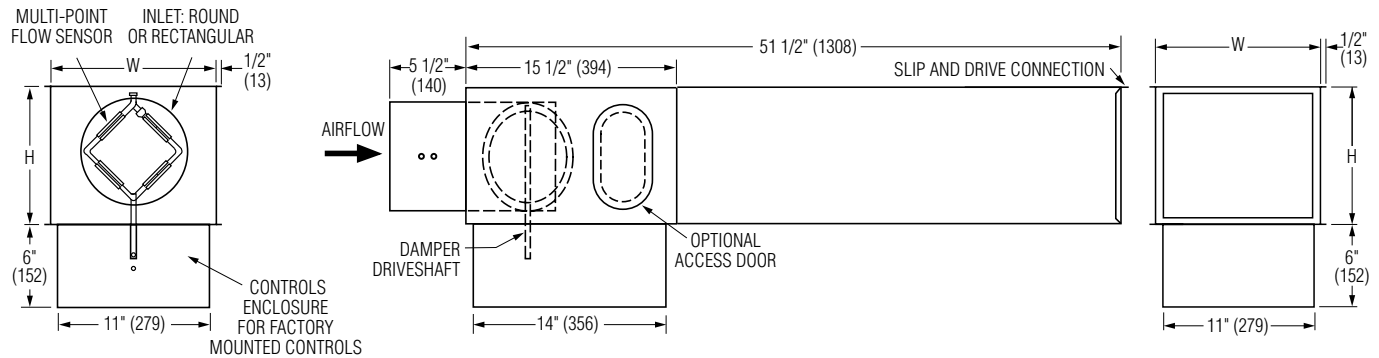

Pneumatic Controls

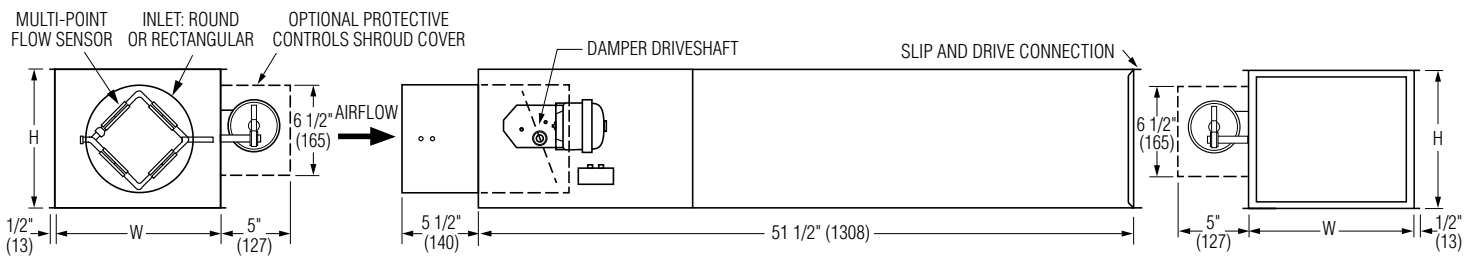

Dimensional Data

Unit Size	Airflow Range* cfm (l/s)	W	H	Inlet Size
4	0 – 225 (0 – 106)	12 (305)	8 (203)	3 7/8 (98) Round
5	0 – 400 (0 – 189)	12 (305)	8 (203)	4 7/8 (124) Round
6	0 – 550 (0 – 260)	12 (305)	8 (203)	5 7/8 (149) Round
7	0 – 800 (0 – 378)	12 (305)	10 (254)	6 7/8 (175) Round
8	0 – 1100 (0 – 519)	12 (305)	10 (254)	7 7/8 (200) Round
9	0 – 1400 (0 – 661)	14 (356)	12 1/2 (318)	8 7/8 (225) Round
10	0 – 1840 (0 – 868)	14 (356)	12 1/2 (318)	9 7/8 (251) Round
12	0 – 2500 (0 – 1180)	16 (406)	15 (381)	11 7/8 (302) Round
14	0 – 3370 (0 – 1590)	20 (508)	17 1/2 (445)	13 7/8 (352) Round
16	0 – 4510 (0 – 2128)	24 (610)	18 (457)	15 7/8 (403) Round
24 x 16	0 – 8330 (0 – 3931)	38 (965)	18 (457)	23 7/8 x 15 7/8 (606 x 403) Rect.

* Maximum airflow limit is based upon 1.5" w.g. (373 Pa) max. differential pressure signal from Diamond Flow Sensor.

A SINGLE DUCT TERMINAL UNITS

Dimensions

Model 31RW • Hot Water Reheat Coil

- One, two, three and four row available.
- Hot water coils have copper tubes and aluminum ripple fins. Coils have 1/2" (13), 7/8" (22) or 1 3/8" (35) O.D. sweat connections.
- Right or left hand coil connection is determined by looking through the terminal inlet in the direction of airflow.
- Galvanized steel casing with slip and drive discharge duct connection.
- Optional low leakage gasketed access door is recommended for coil access and cleaning.
- AHRI Certified coils
- Coil Performance data on pages A92-A100
- Oversized Casing option on pages A90-A91

Digital and Analog Electronic Controls

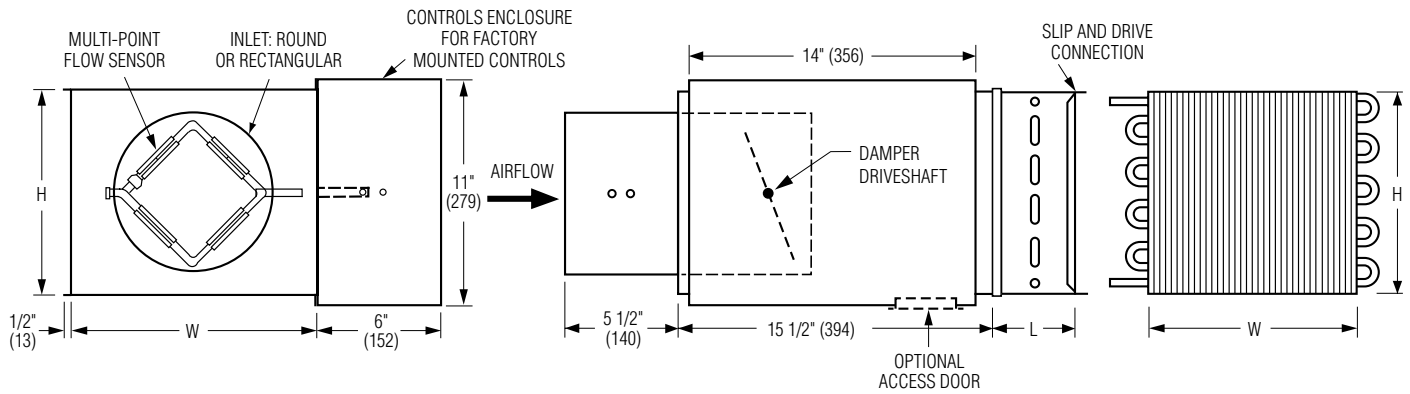

Digital and Analog Electronic Controls with Bottom Mount Controls location

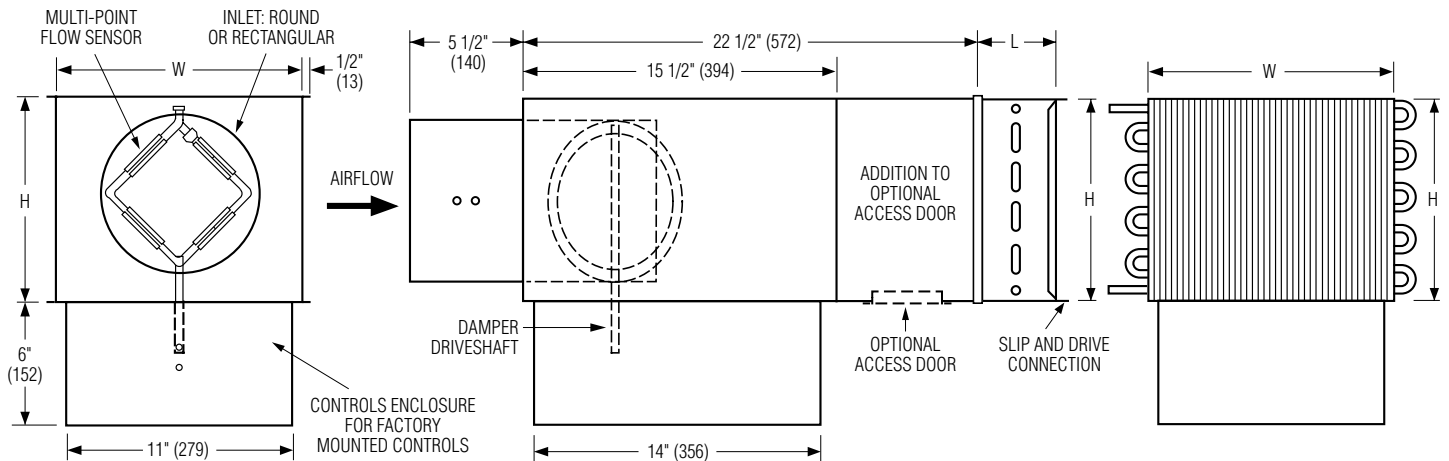

Dimensions

Model 31RW • Integral Attenuator plus Hot Water Reheat Coil

- All the benefits of both the Integral Sound Attenuator and the Hot Water Coils shown above in one.
- Coil performance data on pages A92-A100

Digital and Analog Electronic Controls

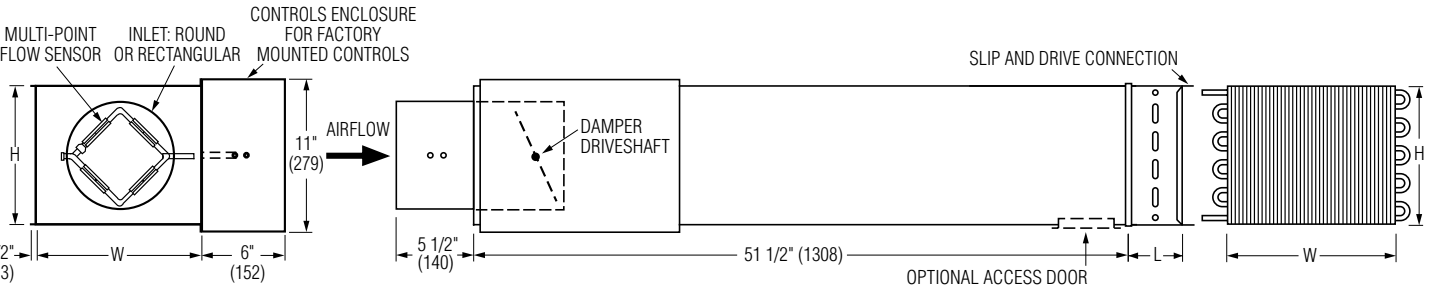

Digital and Analog Electronic Controls with Bottom Mount Controls Location

- Single continuous length terminal construction minimizes casing leakage.
- Continuous internal insulation reduces insulation seams and minimizes airflow disturbance.
- Supplied with same liner as basic unit.

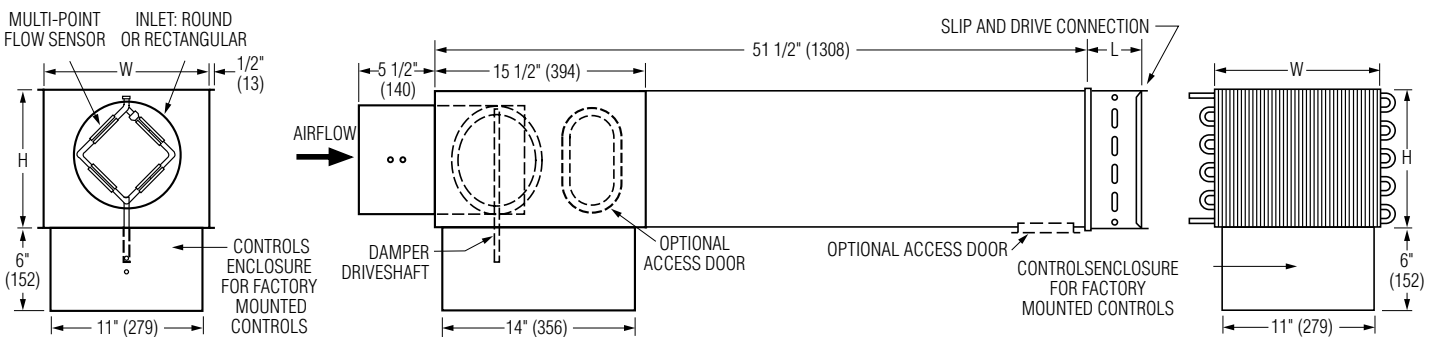

Dimensional Data

Unit Size	W	H	Inlet Size	Coil Connections				Hot Water Coil	
				1 Row	2 Row	3 Row	4 Row	L (1 & 2 Row)	L (3 & 4 Row)
4	12 (305)	8 (203)	3 7/8 (98) Round	1/2 (13)	7/8 (22)	7/8 (22)	7/8 (22)	5 (127)	7 1/2 (191)
5	12 (305)	8 (203)	4 7/8 (124) Round	1/2 (13)	7/8 (22)	7/8 (22)	7/8 (22)	5 (127)	7 1/2 (191)
6	12 (305)	8 (203)	5 7/8 (149) Round	1/2 (13)	7/8 (22)	7/8 (22)	7/8 (22)	5 (127)	7 1/2 (191)
7	12 (305)	10 (254)	6 7/8 (175) Round	1/2 (13)	7/8 (22)	7/8 (22)	7/8 (22)	5 (127)	7 1/2 (191)
8	12 (305)	10 (254)	7 7/8 (200) Round	1/2 (13)	7/8 (22)	7/8 (22)	7/8 (22)	5 (127)	7 1/2 (191)
9	14 (356)	12 1/2 (318)	8 7/8 (225) Round	1/2 (13)	7/8 (22)	7/8 (22)	7/8 (22)	5 (127)	7 1/2 (191)
10	14 (356)	12 1/2 (318)	9 7/8 (251) Round	1/2 (13)	7/8 (22)	7/8 (22)	7/8 (22)	5 (127)	7 1/2 (191)
12	16 (406)	15 (381)	11 7/8 (302) Round	1/2 (13)	7/8 (22)	7/8 (22)	7/8 (22)	5 (127)	7 1/2 (191)
14	20 (508)	17 1/2 (445)	13 7/8 (352) Round	1/2 (13)	7/8 (22)	7/8 (22)	7/8 (22)	5 (127)	7 1/2 (191)
16	24 (610)	18 (457)	15 7/8 (403) Round	7/8 (22)	7/8 (22)	7/8 (22)	7/8 (22)	5 (127)	7 1/2 (191)
24 x 16	38 (965)	18 (457)	23 7/8 x 15 7/8 (606 x 403) Rect.	7/8 (22)	7/8 (22)	1 3/8 (35)	1 3/8 (35)	5 (127)	7 1/2 (191)

SINGLE DUCT TERMINAL UNITS

A

Options:

FMI Removable Flow Sensor

The (FMI) Removable Flow Sensor is a multi-point averaging airflow sensor. Designed to provide accurate sensing by sampling air velocities in four quadrants of a duct, the differential pressure flow sensor provides an averaged reading at an amplification of approximately 2.5 times the velocity pressure, dependent upon nominal size.

Features:

- Removable for cleaning
- All metal construction - no combustible materials in the air stream.
- Amplifies velocity pressure approximately 2.5 times to give a wide range of useful output signal vs. flow.
- Compact size allows for easy removal in tight spaces.
- Sensor design minimizes pressure drop and regenerated noise.
- Label provided on each unit gives airflow direction.
- Multi-point sensing gives an accurate output signal with a maximum deviation of only $\pm 5\%$ with a hard 90 degree elbow, provided a straight inlet condition with a minimum length of two equivalent duct diameters is provided.

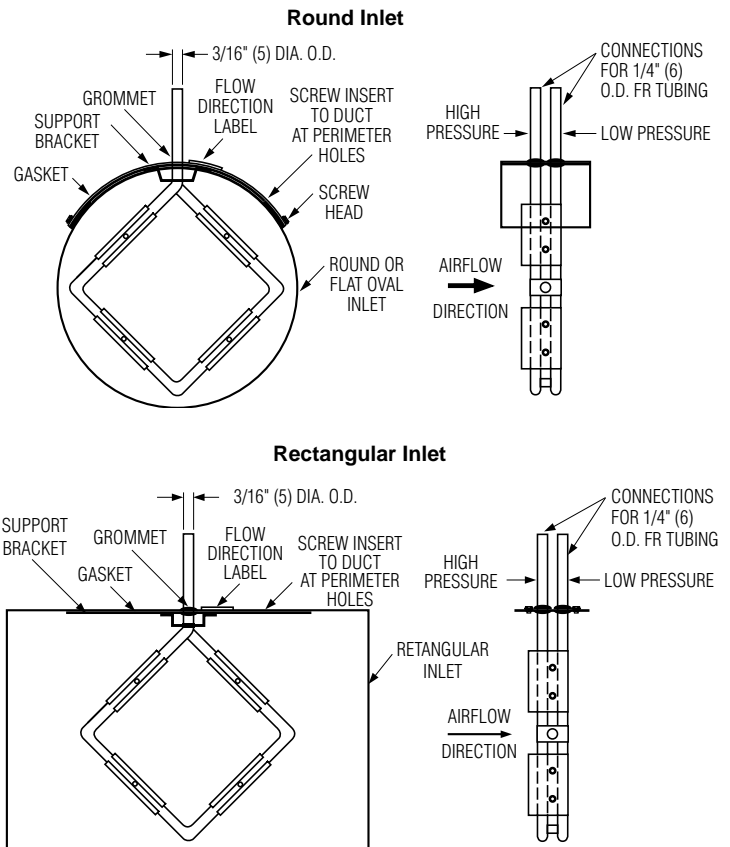

Access Door

Ultra-low leakage, premium quality and performance. Flat oval design.

- Die formed 22 ga. (0.85) galvanized steel flanged frame and door panel.
- Positive bulb door seal
- Plated steel camlock fasteners.
- 1" (25) insulation with 22 ga. (0.85) galv. backing plate.
- Leakage tested in conformance with British Standard DW/142 Class C.
- See 0800-1 submittal for more detailed information.

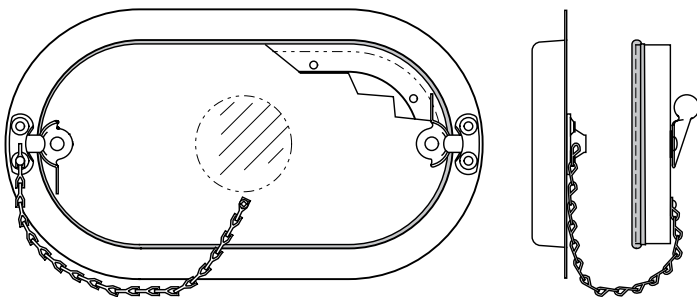

Terminal Unit Size	Nominal Door Size	Max. Leakage 8" w.g. (2 kPa) cfm
4 - 12	8" x 5" (203 x 127)	0.036 cfm (1.02 l/min.)
14 - 24 x 16	12" x 6" (305 x 152)	0.064 cfm (1.8 l/min.)

FF Round Discharge Collar

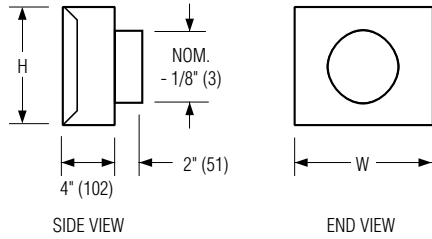

Unit Size	W	H	FF Outlet Size / Oval
4, 5, 6	12 (305)	8 (203)	4, 5, 6 (102, 127, 152)
7, 8	12 (305)	10 (254)	7, 8 (178, 203)
9, 10	14 (356)	12 1/2 (318)	9, 10 (229, 254)
12	16 (406)	15 (381)	12 (305)
14	20 (508)	17 1/2 (445)	14 (356)
16	24 (610)	18 (457)	16 (406)
24 x 16	38 (965)	18 (457)	—

Ultra Low Leakage Casing (ULC) Option, CFM (l/s)

Inlet Size	Pressure, w.g. (Pa)			
	0.5" (124)	1.0" (249)	3" (746)	6" (1049)
4, 5, 6	1 (0.5)	1 (0.5)	3 (1)	6 (3)
7, 8	1 (0.5)	2 (1)	4 (2)	7 (3)
9, 10	1 (0.5)	2 (1)	4 (2)	8 (4)
12	2 (1)	3 (1)	5 (2)	9 (4)
14	2 (1)	3 (1)	5 (2)	9 (4)
16	2 (1)	3 (1)	5 (2)	10 (5)
24 x 16	3 (1)	4 (2)	6 (3)	12 (6)

The ULC option consists of silicone applied to all internal seams during assembly, resulting in an air tight casing to meet the strictest project specifications.

Standard Leakage Casing, CFM (l/s)

Inlet Size	Pressure, w.g. (Pa)		
	0.25" (62)	0.5" (124)	1.0" (249)
4, 5, 6	3 (1)	4 (2)	3 (1)
7, 8	2 (1)	3 (1)	7 (3)
9, 10	2 (1)	3 (1)	5 (2)
12	2 (1)	3 (1)	6 (3)
14	3 (1)	4 (2)	4 (2)
16	3 (1)	4 (2)	6 (3)
24 x 16	7 (3)	9 (4)	7 (3)

A

SINGLE DUCT TERMINAL UNITS

Accessories:

Accessories ordered as separate models.

MOA (Multi-Outlet Attenuator)

MOA313 3' (916) Long

MOA315 5' (1524) Long

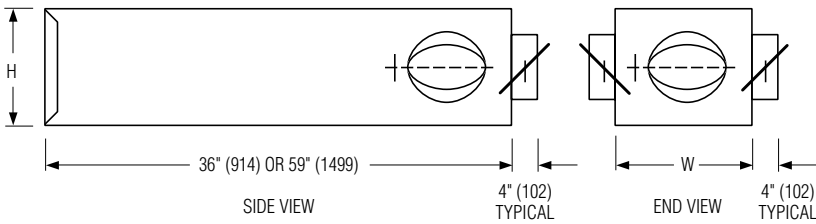

Unit Size	W	H	No. of Outlets	Outlet Size
4, 5, 6	12 (305)	8 (203)	1, 2, or 3	6 (152)
7, 8	12 (305)	10 (254)	2, 3, 4 or 5	6, 8 (152, 203)
9, 10	14 (356)	12 1/2 (318)	3, 4 or 5	8 (203)
	14 (356)	12 1/2 (318)	2, 3 or 4	10 (254)
12	16 (406)	15 (381)	4 or 5	8 (203)
	16 (406)	15 (381)	3, 4 or 5	10 (254)
14	24 (610)	18 (457)	4 or 5	10 (254)
16	38 (965)	18 (457)	4 or 5	10 (254)

FEATURES:

- 22 ga. (0.86) galvanized steel construction, mechanically sealed, low leakage construction.
- Shipped loose for field attachment.
- Only one outlet size to be specified per M.O.A. No mixing of outlet sizes on the same unit.
- Number and size of outlets on M.O.A. not to exceed the limits listed in table, both maximum quantity of outlets and maximum size of outlet.
- All round outlets include manual dampers with hand locking quadrant.
- 3/4" (19) dual density insulation, exposed edges coated to prevent erosion.
- Denotes inlet airflow direction. →
- Slip and drive cleat duct connection.
- For special outlet sizes and arrangements, consult your Nailor representative.

OPTIONS:

- Steri-Liner.
- Fiber-Free Liner.
- 1" (25) Fiberglass Liner.

Standard Outlet Arrangements

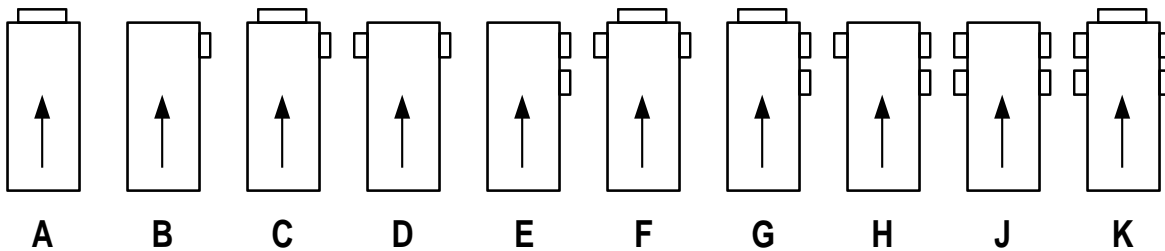

AT Discharge Sound Attenuator

AT313 3' (916) Long

AT315 5' (1524) Long

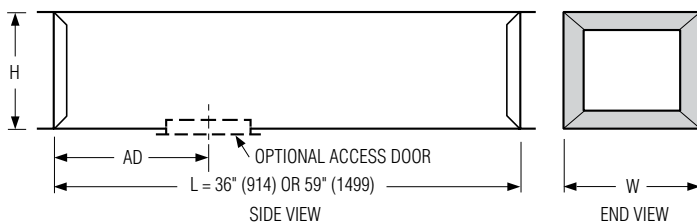

Unit Size	W	H	AD
4, 5, 6	12 (305)	8 (203)	12 (305)
7, 8	12 (305)	10 (254)	12 (305)
9, 10	14 (356)	12 1/2 (318)	12 (305)
12	16 (406)	15 (381)	12 (305)
14	20 (508)	17 1/2 (445)	12 (305)
16	24 (610)	18 (457)	12 (305)
24 x 16	38 (965)	18 (457)	12 (305)

FEATURES:

- 22 ga. (0.86) galvanized steel construction.
- Shipped loose for field attachment.
- Slip and drive connection.
- 3/4" (14) dual density fiberglass insulation, exposed edges coated to prevent erosion as standard.

OPTIONS:

- Steri-Liner.
- Fiber-Free Liner.
- Solid Metal Liner.
- 1" (25) Fiberglass Liner.
- 2" (51) Fiberglass Liner.
- Perforated Metal Liner.
- Steri-Liner with Perforated Liner.
- Access Door
 - Sizes 4 to 12 : 8" x 5" (203 x 127) Oval;
 - Sizes 14 to 24 x 16: 12" x 6" (305 x 152) Oval.

Note: Select Insulation to match VAV terminal.

Recommended Airflow Ranges For Single Duct Pressure Independent Terminal Units

The recommended airflow ranges below are for 3100 Series single duct terminal units with pressure independent controls and are presented as ranges for total and controller specific minimum and maximum airflow. Airflow ranges are based upon maintaining reasonable sound levels and controller limits using Nailor's Diamond Flow Sensor as the airflow measuring device. For a given unit size, the minimum, auxiliary minimum (where applicable) and the maximum flow setting must be within the range limits to ensure pressure independent operation, accuracy, and repeatability.

Actual minimum airflow limits are based upon the sensitivity of the pressure transducer on the controller. Values for .004" (1 Pa) and .02" w.g. (5 Pa) differential pressure signal from Diamond Flow Sensor on digital controls are provided as a reference. For analog controls we show .02" (5 Pa) and .03" (7.5) for pneumatic controllers. These are realistic low limit pressure readings for many transducers used in the digital controls industry. Check your controls supplier for minimum limits. Setting airflow minimums lower than what the transducer will sense, may cause damper hunting and result in a failure to meet minimum ventilation requirements. Factory settings will therefore not be made outside these ranges; however, a minimum setting of zero (shut-off) is an available option on pneumatic units. Where an auxiliary setting is specified, the value must be greater than the minimum setting.



Model 31RW

The high end of the tabulated Total Airflow Range on pneumatic and analog electronic controls represents the Diamond Flow Sensor's differential pressure reading at 1" w.g. (249 Pa). The high end airflow range for digital controls is represented by the indicated transducer differential pressure.

ASHRAE 130 "Performance Rating of Air Terminals" is the method of test for the certification program. The "standard rating condition" (certification rating point) airflow volumes for each terminal unit size are tabulated below per AHRI Standard 880. These air volumes equate to an approximate inlet velocity of 2000 fpm (10.2 m/s).

When digital or other controls are mounted by Nailor, but supplied by others, these values are guidelines only, based upon experience with most controls currently available. Controls supplied by others for factory mounting are configured and calibrated in the field. Airflow settings on pneumatic and analog controls supplied by Nailor are factory preset when provided.

Imperial Units, Cubic Feet per Minute

Unit Size	Inlet Type	Total Airflow Range, cfm	Airflow at 2000 fpm Inlet Velocity (nom.), cfm	Range of Minimum and Maximum Settings, cfm							
				Pneumatic 3000 Controller		Analog Electronic Controls		Digital Controls			
				Transducer Differential Pressure ("w.g.)							
				Min.	Max.	Min.	Max.	Min.		Max.	
		.03	1.0	.02	1.0	.004	.02	1.0	1.5		
4	Round	0 – 225	150	30	180	26	182	12	26	182	223
5		0 – 400	250	55	325	46	325	21	46	325	398
6		0 – 550	400	80	450	64	455	29	64	455	557
7		0 – 800	550	115	650	93	657	42	93	657	805
8		0 – 1100	700	155	900	127	899	57	127	899	1101
9		0 – 1400	900	200	1150	164	1158	73	164	1158	1418
10		0 – 1840	1100	260	1500	212	1497	95	212	1497	1833
12		0 – 2500	1600	355	2050	290	2048	130	290	2048	2508
14		0 – 3370	2100	440	2550	388	2742	173	388	2742	3358
16		0 – 4510	2800	525	3040	521	3683	233	521	3683	4511
24 x 16	Rect.	0 – 8330	5350	1180	6800	961	6797	430	961	6797	8325

Metric Units, Liters per Second

Unit Size	Inlet Type	Total Airflow Range, l/s	Airflow at 10.2 m/s Inlet Velocity (nom.), l/s	Range of Minimum and Maximum Settings, l/s							
				Pneumatic 3000 Controller		Analog Electronic Controls		Digital Controls			
				Transducer Differential Pressure (Pa)							
				Min.	Max.	Min.	Max.	Min.		Max.	
		7.5	249	5	249	1	5	249	374		
4	Round	0 – 106	71	14	85	12	86	6	12	86	105
5		0 – 189	118	26	153	22	153	10	22	153	188
6		0 – 260	189	38	212	30	215	14	30	215	263
7		0 – 378	260	54	307	44	310	20	44	310	380
8		0 – 519	330	73	425	60	425	27	60	425	520
9		0 – 661	425	94	543	77	547	34	77	547	670
10		0 – 868	519	123	708	100	707	45	100	707	866
12		0 – 1180	755	168	967	137	967	61	137	967	1184
14		0 – 1590	991	208	1203	183	1295	82	183	1295	1586
16		0 – 2128	1321	248	1435	246	1739	110	246	1739	2130
24 x 16	Rect.	0 – 3931	2525	557	3209	454	3210	203	454	3210	3931

A SINGLE DUCT TERMINAL UNITS

Performance Data • NC Level Application Guide

3100 Series • Basic Unit

Fiberglass Liner

Inlet Size	Airflow cfm / s		Min. inlet ΔPs "w.g. Pa	NC Levels @ Inlet Pressure (ΔPs) shown																		
				DISCHARGE (basic assembly)					DISCHARGE w/ 36" (914) attenuator					RADIATED								
				Min. ΔPs	0.5" w.g. (125 Pa)	1.0" w.g. (250 Pa)	1.5" w.g. (375 Pa)	2.0" w.g. (500 Pa)	3.0" w.g. (750 Pa)	Min. ΔPs	0.5" w.g. (125 Pa)	1.0" w.g. (250 Pa)	1.5" w.g. (375 Pa)	2.0" w.g. (500 Pa)	3.0" w.g. (750 Pa)	Min. ΔPs	0.5" w.g. (125 Pa)	1.0" w.g. (250 Pa)	1.5" w.g. (375 Pa)	2.0" w.g. (500 Pa)	3.0" w.g. (750 Pa)	
4	225	106	0.53	133	37	*	38	39	40	40	33	*	35	35	36	37	25	25	26	26	27	28
	200	94	0.43	106	35	35	36	37	38	38	32	31	33	33	34	35	22	22	23	24	24	26
	150	71	0.10	25	27	30	31	32	33	33	26	28	29	30	29	30	-	-	-	-	-	22
	100	47	0.11	28	20	23	24	25	26	26	-	22	24	24	25	26	-	-	-	-	-	-
	75	35	0.06	16	-	-	-	20	21	22	-	-	-	-	-	20	-	-	-	-	-	-
5	400	189	0.19	48	24	30	34	37	38	41	-	28	33	37	37	38	-	20	26	30	32	35
	300	142	0.11	28	-	25	29	32	33	36	-	25	29	32	33	35	-	-	20	24	27	31
	250	118	0.05	12	-	21	26	28	30	32	-	-	26	27	29	32	-	-	-	22	25	28
	200	94	0.05	13	-	-	21	23	25	27	-	-	-	21	23	26	-	-	-	-	21	25
125	59	0.02	5	-	-	-	-	-	-	-	-	-	-	-	-	-	-	-	-	-	-	
6	550	260	0.01	2	-	23	29	32	35	39	-	-	25	30	32	34	-	25	29	32	34	37
	450	212	0.01	2	-	-	26	29	32	36	-	-	23	27	29	32	-	21	26	29	31	34
	400	189	0.01	2	-	-	24	28	30	34	-	-	22	24	28	31	-	-	24	27	29	32
	200	94	0.01	2	-	-	-	-	21	25	-	-	-	-	-	21	-	-	-	-	-	22
	100	47	0.01	2	-	-	-	-	-	-	-	-	-	-	-	-	-	-	-	-	-	-
7	800	378	0.01	2	-	20	28	33	36	40	-	-	27	31	35	38	-	23	29	33	36	39
	650	307	0.01	2	-	-	27	32	35	40	-	-	26	31	32	38	-	-	26	30	33	36
	550	260	0.01	2	-	-	26	30	34	38	-	-	26	28	32	37	-	-	24	27	30	34
	335	158	0.01	2	-	-	22	26	29	34	-	-	20	25	27	32	-	-	-	23	25	29
	225	106	0.01	2	-	-	-	24	27	32	-	-	-	23	27	32	-	-	-	-	22	26
8	1100	519	0.01	2	-	24	30	34	37	41	-	22	29	32	36	40	-	26	30	34	37	41
	900	425	0.01	2	-	21	28	32	35	39	-	20	26	31	33	38	-	23	27	31	34	38
	700	330	0.01	2	-	-	26	30	33	37	-	-	25	29	31	34	-	20	24	28	31	35
	600	283	0.01	2	-	-	24	28	31	35	-	-	23	26	28	30	-	-	23	27	30	34
	400	189	0.01	2	-	-	-	24	26	30	-	-	-	22	24	27	-	-	-	22	25	29
9	1400	661	0.01	2	-	23	28	32	34	37	-	23	28	31	33	36	-	26	31	34	36	39
	1250	590	0.01	2	-	21	27	30	33	36	-	20	27	29	33	36	-	24	29	32	34	37
	900	425	0.01	2	-	-	22	26	28	31	-	-	22	26	27	29	-	-	23	26	28	32
	675	319	0.01	2	-	-	-	23	25	29	-	-	-	21	23	27	-	-	-	21	24	29
	450	212	0.01	2	-	-	-	-	-	23	-	-	-	-	-	22	-	-	-	-	20	25
10	1850	873	0.01	2	-	23	29	32	35	38	-	22	26	30	33	36	-	31	35	37	39	41
	1650	779	0.01	2	-	22	27	31	33	37	-	21	27	28	31	34	-	29	33	35	36	39
	1100	519	0.01	2	-	-	22	26	28	32	-	-	-	23	26	28	-	20	24	26	28	30
	825	389	0.01	2	-	-	-	22	25	28	-	-	-	-	22	26	-	-	-	-	23	27
	550	260	0.01	2	-	-	-	-	21	25	-	-	-	-	-	21	-	-	-	-	-	22
12	2500	1180	0.01	2	-	27	32	35	36	39	-	27	31	35	35	36	-	28	33	36	39	42
	2000	944	0.01	2	-	24	28	31	33	36	-	22	26	29	30	33	-	24	30	33	35	38
	1600	755	0.01	2	-	-	24	27	29	33	-	-	21	24	26	30	-	20	26	29	31	35
	1200	566	0.01	2	-	-	-	23	25	29	-	-	-	21	22	25	-	-	22	25	27	30
	800	378	0.01	2	-	-	-	-	-	23	-	-	-	-	-	21	-	-	-	22	24	27
14	3125	1475	0.01	2	-	29	34	36	38	40	-	29	33	35	37	39	-	25	29	32	34	37
	2700	1274	0.01	2	-	26	31	33	35	37	-	25	29	32	34	36	-	22	26	29	31	35
	2100	991	0.01	2	-	21	25	28	29	32	-	21	25	28	29	32	-	-	21	25	27	31
	1550	731	0.01	2	-	-	-	22	24	27	-	-	-	21	22	24	-	-	-	21	23	27
	1050	495	0.01	2	-	-	-	-	-	21	-	-	-	-	-	-	-	-	-	-	-	22
16	3725	1758	0.03	8	-	30	34	37	39	41	-	29	34	36	39	41	-	29	34	38	40	44
	3500	1652	0.03	8	-	28	33	35	37	40	-	25	30	35	37	38	-	28	33	37	39	43
	2800	1321	0.02	6	-	23	27	30	31	34	-	21	26	30	31	34	-	24	30	33	35	40
	2100	991	0.02	4	-	-	-	22	24	26	-	-	-	22	23	25	-	-	25	28	31	36
	1400	661	0.01	3	-	-	-	-	-	-	-	-	-	-	-	-	-	-	-	22	25	29
24 x 16	8330	3931	0.02	5	49	50	49	52	53	53	48	48	48	51	52	52	43	44	49	51	54	57
	7000	3303	0.02	4	45	45	46	48	50	50	44	44	44	47	49	49	40	41	47	49	51	55
	6000	2831	0.01	2	40	42	43	45	47	48	38	40	42	44	45	47	36	39	45	47	49	52
	5350	2525	0.01	2	35	38	40	43	45	47	34	36	39	42	44	45	32	38	44	46	48	51
	4000	1888	0.01	2	25	31	35	37	40	42	23	30	34	36	39	41	24	35	39	43	45	47
	3000	1416	0.01	2	-	23	29	31	35	38	-	22	28	30	34	37	-	31	36	38	40	44

Performance Notes:

1. NC Levels are calculated based on procedures as outlined on page A101.
2. Dash (-) in space indicates a NC less than 20.
3. Asterisk (*) in space indicates that the minimum inlet static pressure requirement is greater than 0.5" w.g. (125 Pa) at rated airflow.

Performance Data • Discharge Sound Power Levels

3100 Series • Basic Unit

Fiberglass Liner



A
SINGLE DUCT TERMINAL UNITS

Inlet Size	Airflow		Min. inlet ΔPs		Sound Power Octave Bands @ Inlet Pressure (ΔPs) shown																																			
					Minimum ΔPs		0.5" wg (125Pa) ΔPs			1.0" wg (250Pa) ΔPs			1.5" wg (375Pa) ΔPs			2.0" wg (500Pa) ΔPs			3.0" wg (750Pa) ΔPs																					
					"w.g.	Pa	2	3	4	5	6	7	2	3	4	5	6	7	2	3	4	5	6	7	2	3	4	5	6	7	2	3	4	5	6	7				
4	225	106	0.53	133	78	72	60	53	51	40	*	*	*	*	*	*	79	73	63	57	54	45	79	74	65	59	56	49	80	74	67	61	58	51	80	75	69	63	60	54
	200	94	0.43	106	76	69	57	50	48	37	76	69	58	51	49	38	77	71	62	55	53	44	78	71	64	58	55	47	78	72	65	59	56	50	79	73	67	62	58	53
	150	71	0.10	25	70	61	46	38	36	21	72	64	54	48	45	35	73	65	57	52	48	40	74	66	59	54	51	44	74	66	61	56	52	46	75	67	63	58	54	50
	100	47	0.11	28	64	53	40	34	31	17	67	56	48	43	39	30	68	57	51	47	43	36	68	58	53	49	45	39	69	58	55	51	46	41	69	59	57	53	49	45
	75	35	0.06	16	60	46	33	27	24	9	63	50	43	39	35	27	64	51	47	43	39	32	64	52	49	46	41	36	65	53	50	47	42	38	65	53	53	50	44	41
5	400	189	0.19	48	64	65	58	51	43	35	69	70	64	57	50	43	72	74	69	61	55	49	74	76	71	63	58	52	76	77	73	65	60	55	78	79	76	67	62	58
	300	142	0.11	28	58	58	51	44	37	27	65	65	60	53	47	40	69	69	65	57	52	45	71	71	68	59	54	49	72	72	69	61	56	51	74	74	72	63	59	55
	250	118	0.05	12	52	51	43	37	29	18	63	62	58	51	45	37	66	66	63	55	50	43	68	68	65	57	52	47	70	69	67	59	54	49	71	71	70	61	57	53
	200	94	0.05	13	49	47	41	34	27	15	60	58	55	48	42	35	63	62	60	52	47	41	65	64	62	54	50	44	67	65	64	56	52	47	69	67	67	58	55	50
	125	59	0.02	5	38	34	29	23	15	2	54	50	49	41	37	30	57	53	54	45	42	36	59	55	56	48	45	39	60	57	58	49	47	41	62	59	61	52	49	45
6	550	260	0.01	2	48	35	30	31	17	-	67	64	61	55	47	39	70	69	66	59	52	46	72	72	70	61	55	50	74	74	72	63	57	53	76	77	75	65	60	57
	450	212	0.01	2	45	32	27	28	15	-	65	62	58	52	45	37	68	67	63	56	50	44	70	70	66	58	53	48	71	72	69	60	55	51	73	75	72	63	59	55
	400	189	0.01	2	44	31	25	27	14	-	63	60	56	50	44	36	67	65	61	54	49	43	68	68	65	57	52	47	70	70	67	59	54	50	72	74	70	61	58	54
	200	94	0.01	2	36	22	15	17	8	-	55	51	45	41	38	30	58	57	51	45	43	37	60	60	54	47	46	41	62	62	56	49	48	44	64	65	59	52	51	48
	100	47	0.01	2	28	14	4	8	1	-	47	43	34	31	31	25	50	48	40	36	37	31	52	51	43	38	40	36	54	53	45	40	42	38	56	56	49	42	45	42
7	800	378	0.01	2	45	26	29	40	14	2	68	63	61	59	48	44	72	70	67	63	55	51	75	73	70	65	58	56	76	76	72	66	61	59	79	80	76	68	64	63
	650	307	0.01	2	43	25	26	37	12	-	66	62	58	56	46	42	70	68	64	60	53	49	73	72	67	62	56	54	75	75	69	63	59	57	77	78	73	65	62	61
	550	260	0.01	2	42	24	24	34	11	-	65	60	56	53	45	41	69	67	61	57	51	48	71	71	64	59	55	52	73	73	67	60	57	56	75	77	70	62	61	60
	335	158	0.01	2	38	20	17	26	6	-	61	57	48	45	40	36	65	63	54	49	46	44	67	67	57	51	50	48	69	70	60	52	52	51	71	74	63	54	56	56
	225	106	0.01	2	34	17	11	20	2	-	57	54	42	39	36	33	61	60	48	42	43	41	63	64	51	44	46	45	65	67	54	46	49	48	68	71	57	48	52	52
8	1100	519	0.01	2	52	34	26	32	20	5	71	66	60	59	51	43	74	72	66	63	57	50	76	75	70	66	60	54	77	77	72	68	62	57	79	81	76	71	66	61
	900	425	0.01	2	50	32	24	30	19	3	69	64	58	56	50	42	72	70	64	61	55	49	74	73	68	64	58	53	75	75	70	65	61	56	77	79	74	68	64	60
	700	330	0.01	2	48	29	22	27	17	2	67	61	56	53	48	40	70	67	62	58	53	47	72	71	65	60	56	51	73	73	68	62	59	54	75	76	71	65	62	58
	600	283	0.01	2	47	27	20	25	16	1	65	60	54	51	46	39	68	66	60	56	52	46	70	69	64	58	55	50	72	71	66	60	57	53	74	75	70	63	61	57
	400	189	0.01	2	43	23	17	20	12	-	61	56	51	46	43	36	65	62	57	51	49	43	67	65	60	53	52	47	68	67	63	55	54	50	70	71	66	58	57	54
9	1400	661	0.01	2	55	38	38	38	24	10	72	65	64	60	52	45	74	70	68	63	57	51	76	73	71	65	60	55	77	75	73	67	63	57	79	77	75	69	65	61
	1250	590	0.01	2	54	37	36	37	23	9	70	64	62	58	51	44	73	69	66	62	56	50	75	71	69	64	59	54	76	73	71	65	61	56	78	76	74	68	64	60
	900	425	0.01	2	50	33	32	32	20	7	66	60	57	53	48	42	69	65	62	57	53	48	71	68	64	59	56	52	72	70	66	61	58	54	74	72	69	63	61	58
	675	319	0.01	2	46	30	28	28	17	5	63	57	53	49	45	40	65	62	58	53	50	46	67	64	60	55	53	50	68	66	62	57	56	52	70	69	65	59	59	56
	450	212	0.01	2	41	25	22	23	13	2	58	52	47	44	42	37	60	57	52	48	47	43	62	60	54	50	50	47	63	62	56	51	52	50	65	65	59	54	55	53
10	1850	873	0.01	2	54	38	37	36	23	14	72	65	65	61	54	48	75	70	68	65	59	54	77	73	73	68	63	58	78	75	75	70	65	60	80	78	78	72	68	64
	1650	779	0.01	2	53	36	35	34	22	13	70	64	63	59	53	47	73	69	68	64	59	53	75	72	71	66	62	57	77	74	73	68	64	59	78	77	76	71	67	63
	1100	519	0.01	2	48	32	30	30	19	10	65	60	58	55	50	44	69	65	63	59	55	50	70	68	66	62	59	54	72	70	68	64	61	57	73	73	71	66	64	60
	825	389	0.01	2	44	29	27	26	17	8	62	57	55	51	48	42	65	62	60	56	53	48	67	65	63	58	56	52	68	67	65	60	58	54	70	70	68	63	62	58
	550	260	0.01	2	39	25	22	22	14	5	57	53	50	47	44	39	60	58	55	51	50	45	62	61	58	54	53	49	63	63	60	56	55	51	65	66	63	58	58	55
12	2500	1180	0.01	2	55	37	43	36	30	16	75	66	67	62	57	50	78	71	72	66	62	56	80	74	74	69	65	60	82	76	76	71	67	62	84	79	79	73	69	66
	2000	944	0.01	2	52	35	39	33	28	15	72	63	64	59	55	49	75	68	68	64	60	55	77	71	71	66	63	58	79	73	73	68	65	61	81	76	75	71	67	64
	1600	755	0.01	2	49	32	36	31	26	13	69	61	61	57	53	47	72	66	65	61	58	53	75	69	68	64	61	57	76	71	69	66	63	59	78	74	72	69	65	63
	1200	566	0.01	2	45	29	31	28	24	12	65	57	56	54	51	45	69	62	61	58	55	51	71	65	63	61	58													

Performance Data • Discharge Sound Power Levels
3100 Series • With 3 ft. (914) Integral Attenuator
Fiberglass Liner

Inlet Size	Airflow		Min. inlet ΔPs		Sound Power Octave Bands @ Inlet Pressure (ΔPs) shown																																			
					Minimum ΔPs					0.5" wg (125Pa) ΔPs					1.0" wg (250Pa) ΔPs					1.5" wg (375Pa) ΔPs					2.0" wg (500Pa) ΔPs					3.0" wg (750Pa) ΔPs										
					2	3	4	5	6	7	2	3	4	5	6	7	2	3	4	5	6	7	2	3	4	5	6	7	2	3	4	5	6	7	2	3	4	5	6	7
4	225	106	0.53	133	75	67	51	37	29	20	*	*	*	*	*	*	76	72	59	49	34	26	76	74	62	52	35	30	77	73	63	53	37	32	77	73	64	55	39	35
	200	94	0.43	106	74	64	48	34	26	18	73	69	53	43	30	20	74	71	57	48	34	27	75	71	60	51	36	31	75	71	61	52	36	32	76	72	63	54	36	33
	150	71	0.10	25	69	56	37	22	17	7	70	61	50	40	26	-	71	65	53	44	28	22	72	65	55	47	29	27	71	66	56	48	30	28	72	67	58	50	32	31
	100	47	0.11	28	63	50	32	18	12	3	66	56	45	36	23	21	68	56	47	38	25	21	67	56	48	39	25	22	68	57	50	39	24	23	69	58	52	40	25	25
	75	35	0.06	16	59	43	25	11	5	-	62	49	38	31	-	-	64	50	42	33	25	-	63	51	44	33	-	-	64	50	47	37	22	-	64	53	51	41	26	23
5	400	189	0.19	48	61	60	49	35	21	15	66	68	59	48	30	24	69	73	65	53	34	30	71	76	68	56	37	33	73	76	69	57	39	36	75	77	71	59	41	39
	300	142	0.11	28	56	53	42	28	15	8	62	65	55	45	28	22	66	69	60	50	33	28	68	71	64	52	35	33	69	72	65	54	36	33	71	73	68	55	37	35
	250	118	0.05	12	51	46	34	21	10	4	61	59	54	43	26	-	64	66	59	47	29	25	66	67	61	50	30	30	67	69	63	51	32	31	68	71	65	53	35	34
	200	94	0.05	13	48	44	33	18	8	13	59	58	52	41	26	22	63	61	56	43	29	26	64	62	57	44	30	27	66	64	59	44	30	28	69	66	62	45	31	30
	125	59	0.02	5	37	31	22	7	-	0	53	49	44	33	21	21	57	52	49	35	28	22	58	54	51	35	22	-	59	54	55	39	26	23	61	56	59	44	31	27
6	550	260	0.01	2	45	28	21	15	-	-	64	60	56	46	27	20	67	66	62	51	31	27	69	70	67	54	34	31	71	72	68	55	36	34	73	73	70	57	39	38
	450	212	0.01	2	43	25	18	12	-	-	62	60	53	44	26	-	65	65	59	49	31	27	67	68	62	51	34	32	68	69	65	53	35	33	70	72	68	55	37	35
	400	189	0.01	2	43	24	16	11	-	-	61	59	52	42	25	-	65	63	57	47	29	25	66	65	61	50	30	30	67	68	62	51	32	32	69	72	65	53	36	35
	200	94	0.01	2	35	17	7	1	-	-	54	49	42	34	22	-	58	54	47	37	25	22	59	56	49	37	26	24	61	58	51	38	26	26	64	62	54	39	27	28
	100	47	0.01	2	27	13	-	-	-	-	46	40	29	23	-	-	50	46	35	25	23	-	51	48	38	25	-	-	53	52	42	29	22	-	55	56	47	34	27	24
7	800	378	0.01	2	45	22	23	30	-	-	68	62	57	54	32	26	72	69	63	57	37	33	74	72	67	60	40	37	75	75	69	61	42	40	77	78	71	62	46	44
	650	307	0.01	2	42	21	20	27	-	-	66	62	54	50	29	24	70	67	60	54	35	31	73	71	63	56	38	36	74	72	66	57	40	38	76	77	69	59	43	42
	550	260	0.01	2	41	21	18	25	-	-	64	60	52	47	27	21	68	67	58	51	32	29	70	69	61	53	36	35	72	72	63	54	38	37	74	76	66	56	41	41
	335	158	0.01	2	37	18	11	21	1	-	60	56	45	39	23	-	64	62	50	42	28	27	66	66	53	43	32	31	68	68	56	44	33	34	70	72	59	46	36	37
	225	106	0.01	2	33	14	10	18	-	-	56	53	38	33	26	20	60	59	44	35	27	25	62	63	48	36	27	27	64	67	51	39	30	30	67	71	54	42	35	34
8	1100	519	0.01	2	51	33	24	29	6	-	70	65	58	56	38	26	73	70	63	60	42	32	75	73	66	62	45	35	76	76	69	64	47	38	78	80	73	66	50	42
	900	425	0.01	2	49	30	22	26	5	-	68	63	56	53	35	23	71	68	61	57	39	30	73	72	64	59	42	33	74	74	67	61	44	37	76	78	71	63	47	41
	700	330	0.01	2	47	28	20	23	3	-	66	59	53	48	30	-	69	66	59	53	36	28	71	70	62	56	40	32	72	71	65	58	42	35	74	73	69	60	45	39
	600	283	0.01	2	46	26	18	21	2	-	64	58	51	45	27	-	67	64	57	50	34	26	69	67	61	53	39	33	71	69	64	56	41	36	73	71	67	59	44	40
	400	189	0.01	2	42	20	16	17	-	-	60	56	47	41	26	-	64	61	54	46	32	26	66	64	58	49	36	30	67	65	60	51	38	32	69	68	62	55	41	36
9	1400	661	0.01	2	54	35	34	31	8	-	71	65	60	54	37	29	73	69	64	58	42	35	75	72	66	60	44	38	76	74	68	61	46	41	79	76	71	63	49	44
	1250	590	0.01	2	53	34	33	30	7	-	69	61	59	53	36	28	72	69	63	56	40	34	74	70	65	58	43	37	75	73	67	60	45	39	77	76	70	62	47	43
	900	425	0.01	2	49	31	26	26	4	-	65	59	53	47	30	23	68	64	58	51	36	30	70	68	61	53	39	35	71	69	63	54	41	37	73	70	65	56	43	40
	675	319	0.01	2	45	28	23	22	3	-	63	56	48	42	27	21	65	60	53	46	33	29	67	62	56	48	36	33	68	64	58	50	38	36	69	68	61	52	41	39
	450	212	0.01	2	40	25	18	18	-	-	57	52	43	37	24	21	59	56	48	41	29	27	61	59	52	43	32	31	62	61	53	45	34	33	64	64	55	47	37	36
10	1850	873	0.01	2	54	38	31	26	6	2	70	64	60	53	38	34	74	68	65	57	43	40	75	71	68	60	46	44	77	74	70	61	48	46	79	76	73	64	50	49
	1650	779	0.01	2	52	33	31	25	6	3	70	61	60	52	37	34	73	69	65	57	42	39	74	70	67	59	45	42	76	72	69	61	47	45	77	75	72	63	50	48
	1100	519	0.01	2	46	27	22	21	2	-	63	57	53	46	32	27	66	62	58	50	37	34	68	66	62	53	40	38	70	68	64	54	42	40	71	70	66	57	45	43
	825	389	0.01	2	43	26	20	18	3	2	60	55	49	42	30	26	62	59	55	47	35	32	64	62	58	49	38	36	65	64	60	51	40	38	67	68	63	53	43	41
	550	260	0.01	2	36	21	16	14	-	-	54	51	45	38	27	24	57	56	50	42	32	30	60	59	54	44	35	33	61	61	55	46	36	35	62	63	58	49	39	38
12	2500	1180	0.01	2	53	35	35	25	11	3	75	65	63	54	40	37	78	69	68	58	45	43	80	72	70	60	47	46	81	74	72	62	49	48	82	76	74	64	51	52
	2000	944	0.01	2	51	34	32	23	9	1	71	62	59	51	37	35	74	67	64	55	42	41	76	69	67	58	45	45	77	71	68	60	47	47	79	73	71	62	50	50
	1600	755	0.01	2	49	32	29	21	8	1	67	60	56	48	36	33	70	64	60	53	40	39	73	66	63	55	43	43	73	68	65	57	45	45	76	72	68	59	48	49
	1200	566	0.01	2	42	28	26	18	7	1	62	55	52	45	33	31	67	60	56	49	38	37	69	63	58	51	41	41	71	64	60	53	43	43	72	67	63	56	46	46
	800	378	0.01	2	38	21	19	13	4	-	57	50	45	39	29	28	60	56	49	44	34	34	63	59																

Performance Data • Radiated Sound Power Levels

3100 Series • Basic Unit

Fiberglass Liner



SINGLE DUCT TERMINAL UNITS

Inlet Size	Airflow		Min. inlet ΔPs		Sound Power Octave Bands @ Inlet Pressure (ΔPs) shown																																			
					Minimum ΔPs		0.5" wg (125Pa) ΔPs					1.0" wg (250Pa) ΔPs					1.5" wg (375Pa) ΔPs					2.0" wg (500Pa) ΔPs					3.0" wg (750Pa) ΔPs													
					"w.g.	Pa	2	3	4	5	6	7	2	3	4	5	6	7	2	3	4	5	6	7	2	3	4	5	6	7	2	3	4	5	6	7	2	3	4	5
4	225	106	0.53	133	62	54	45	43	42	32	62	54	44	42	42	32	63	55	48	45	44	36	63	56	50	46	45	39	63	57	51	47	46	41	64	58	53	48	47	44
	200	94	0.43	106	60	51	42	40	39	29	60	52	43	41	40	30	61	53	46	43	42	34	61	54	48	44	43	37	61	55	50	45	44	39	62	56	52	47	45	42
	150	71	0.10	25	53	43	31	32	30	14	55	46	39	37	35	25	56	48	42	39	37	30	57	49	44	41	38	32	57	50	46	41	39	34	57	51	48	43	40	37
	100	47	0.11	28	47	35	25	27	24	8	49	39	33	32	28	-	49	41	37	34	30	23	50	42	39	35	32	25	50	42	40	36	32	27	51	43	42	37	34	30
	75	35	0.06	16	42	29	18	21	17	-	44	34	29	28	24	-	45	35	33	30	26	-	45	36	35	31	27	21	46	37	36	32	28	23	46	38	38	34	29	25
5	400	189	0.19	48	49	46	38	38	33	18	56	52	45	43	38	27	62	57	50	46	42	33	65	60	53	48	44	37	67	62	55	49	45	39	70	65	58	51	47	43
	300	142	0.11	28	42	37	29	31	25	9	53	47	40	38	33	23	58	52	45	41	37	29	61	55	48	43	39	33	64	57	51	44	41	35	67	60	54	46	43	39
	250	118	0.05	12	34	28	21	24	18	-	51	44	38	35	30	20	56	49	43	38	34	27	60	52	46	40	36	30	62	53	48	41	38	33	65	56	51	43	40	36
	200	94	0.05	13	32	24	17	21	14	-	49	40	34	31	26	-	54	45	39	34	30	24	57	48	42	36	32	27	59	50	44	37	34	30	62	52	47	39	36	33
	125	59	0.02	5	20	9	3	9	2	-	44	32	27	23	-	-	49	36	32	27	22	-	52	39	35	28	25	21	54	41	37	30	26	23	57	44	40	32	28	27
6	550	260	0.01	2	42	27	27	10	2	-	60	54	50	37	33	25	63	59	55	42	38	32	65	62	57	45	41	36	66	64	59	47	43	40	68	66	61	50	47	44
	450	212	0.01	2	40	25	24	7	-	-	58	52	47	35	30	22	61	56	51	40	35	29	63	59	54	42	38	34	64	61	56	44	41	37	66	64	58	47	44	41
	400	189	0.01	2	39	23	22	5	-	-	56	50	45	33	28	20	60	55	50	38	33	28	61	58	52	41	37	32	63	60	54	43	39	35	64	62	56	46	42	39
	200	94	0.01	2	32	15	11	-	-	-	49	41	35	23	-	-	53	46	39	28	24	-	54	49	41	31	27	22	56	51	43	33	29	25	57	54	45	36	32	30
	100	47	0.01	2	25	6	0	-	-	-	42	33	24	-	-	-	45	37	28	-	-	-	47	40	30	21	-	-	49	42	32	23	-	-	50	45	34	26	22	-
7	800	378	0.01	2	37	19	16	19	15	-	59	51	49	43	39	29	63	56	55	47	43	35	65	60	58	49	45	39	67	62	61	51	47	42	69	65	64	54	49	46
	650	307	0.01	2	35	18	13	16	12	-	57	49	46	40	35	26	61	55	52	44	40	33	63	58	55	46	42	36	64	61	58	48	44	39	67	64	61	51	46	43
	550	260	0.01	2	33	17	11	14	10	-	55	48	44	37	33	24	59	54	50	42	37	30	61	57	53	44	40	34	62	60	56	46	41	37	65	63	59	48	44	40
	335	158	0.01	2	27	13	4	7	2	-	49	45	37	30	26	-	53	51	43	34	30	23	55	54	46	37	32	27	57	56	49	39	34	30	59	60	52	41	36	34
	225	106	0.01	2	22	11	-	1	-	-	44	42	32	24	-	-	48	48	38	29	24	-	50	51	41	31	26	22	52	54	44	33	28	24	54	57	47	35	30	28
8	1100	519	0.01	2	45	21	6	13	5	-	63	54	45	41	35	30	66	60	52	46	40	37	68	63	56	49	43	41	69	66	59	51	45	44	71	69	63	53	48	48
	900	425	0.01	2	43	19	4	11	3	-	61	52	43	39	33	28	64	58	50	44	38	35	66	61	54	46	41	39	67	64	57	48	43	42	69	67	61	51	46	46
	700	330	0.01	2	41	17	2	8	1	-	58	50	41	36	30	26	61	56	47	41	36	33	63	59	51	44	39	37	64	61	54	46	41	40	66	65	58	48	44	44
	600	283	0.01	2	39	15	0	7	-	-	57	48	39	34	29	24	60	54	46	39	34	31	62	57	50	42	37	35	63	60	53	44	39	38	65	63	57	47	42	42
	400	189	0.01	2	35	11	-	2	-	-	53	44	35	30	25	20	56	50	42	35	30	27	58	54	46	38	33	31	59	56	49	40	35	34	61	59	53	42	38	38
9	1400	661	0.01	2	41	14	28	19	7	-	60	50	52	42	36	23	64	56	56	46	41	31	66	60	59	48	44	36	67	62	61	50	47	40	69	66	63	52	50	44
	1250	590	0.01	2	40	13	26	18	6	-	59	49	50	41	35	23	63	55	55	45	40	31	65	59	57	47	43	36	66	61	59	49	46	39	68	65	61	51	49	44
	900	425	0.01	2	36	10	21	14	3	-	55	46	45	37	32	21	59	52	49	41	37	29	61	56	52	43	40	34	62	58	54	45	43	37	64	62	56	47	46	42
	675	319	0.01	2	33	7	16	11	-	-	52	43	40	34	30	-	55	49	45	38	35	28	57	53	47	40	38	32	59	56	49	42	40	36	61	59	52	44	43	41
	450	212	0.01	2	28	4	9	7	-	-	47	39	34	29	26	-	50	46	38	33	31	25	52	49	41	36	34	30	54	52	42	37	36	34	56	56	45	40	39	38
10	1850	873	0.01	2	22	15	37	16	-	-	56	50	57	44	33	-	62	56	60	49	41	31	65	60	62	52	46	38	68	62	64	54	49	43	71	66	66	56	54	49
	1650	779	0.01	2	21	14	35	15	-	-	54	49	54	42	31	-	60	55	58	47	39	30	64	58	60	50	44	36	66	61	61	52	48	41	70	65	63	55	53	48
	1100	519	0.01	2	16	9	27	8	-	-	49	44	46	36	26	-	55	51	50	41	34	25	59	54	52	44	39	31	61	57	53	46	43	36	65	61	55	49	47	43
	825	389	0.01	2	12	6	21	4	-	-	46	42	41	32	22	-	51	48	44	37	31	21	55	51	46	39	35	28	57	54	48	41	39	33	61	58	50	44	44	39
	550	260	0.01	2	7	2	13	-	-	-	40	37	33	26	-	-	46	44	36	30	25	-	50	47	38	33	30	23	52	50	40	35	34	28	56	53	42	38	39	34
12	2500	1180	0.01	2	40	27	26	23	15	-	64	53	52	46	42	31	68	58	56	51	46	37	71	61	59	53	49	40	73	63	61	55	51	43	75	65	63	57	54	46
	2000	944	0.01	2	37	26	23	20	12	-	61	52	49	44	39	29	66	57	53	48	43	34	68	59	56	50	46	38	70	61	58	52	48	40	72	64	60	54	51	44
	1600	755	0.01	2	34	24	20	17	9	-	58	51	46	41	36	26	63	55	50	45	41	32	65	58	53	47	43	35	67	60	55	49	45	38	69	63	58	51	48	41
	1200	566	0.01	2	31	23	17	14	6	-	55	49	42	37	32	23	59	53	47	41	37	29	62	56	49	43	40	32	63	58	51	45	42	34	66	61	54	47	44	38
	800	378	0.01	2	2																																			

Performance Data • AHRI Certification and Performance Notes

3100 Series • Basic Unit • AHRI Certification Rating Points

Fiberglass Liner

Inlet Size	Airflow		Min. Inlet ΔPs		Discharge Sound Power Levels @ 1.5" w.g. (375 Pa) ΔPs							Radiated Sound Power Levels @ 1.5" w.g. (375 Pa) ΔPs						
					Octave Band							Octave Band						
	cfm	l/s	"w.g.	Pa	2	3	4	5	6	7	2	3	4	5	6	7		
4	150	71	0.10	25	74	66	59	54	51	44	57	49	44	41	38	32		
5	250	118	0.05	12	68	68	65	57	52	47	60	52	46	40	36	30		
6	400	189	0.01	2	68	68	65	57	52	47	61	58	52	41	37	32		
7	550	260	0.01	2	71	71	64	59	55	52	61	57	53	44	40	34		
8	700	330	0.01	2	72	71	65	60	56	51	63	59	51	44	39	37		
9	900	425	0.01	2	71	68	64	59	56	52	61	56	52	43	40	34		
10	1100	519	0.01	2	70	68	66	62	59	54	59	54	52	44	39	31		
12	1600	755	0.01	2	75	69	68	64	61	57	65	58	53	47	43	35		
14	2100	991	0.01	2	75	68	67	64	61	57	61	56	49	45	42	35		
16	2800	1321	0.02	5	77	69	68	63	60	56	67	62	58	50	46	41		
24 x 16	5350	2525	0.01	2	87	81	79	76	72	69	72	70	70	65	60	55		



Ratings are certified in accordance with AHRI Standards.

Performance Notes for Sound Power Levels:

- Discharge sound power is the noise emitted from the unit discharge into the downstream duct. Discharge Sound Power Levels (SWL) now include duct end reflection energy as part of the standard rating. Including the duct end correction provides sound power levels that would normally be transmitted into an acoustically, non-reflective duct. The effect of including the energy correction to the discharge SWL, is higher sound power levels when compared to previous AHRI certified data. For more information on duct end reflection calculations see AHRI Standard 880.
- Radiated sound power is the breakout noise transmitted through the unit casing walls.
- Sound power levels are in decibels, dB re 10⁻¹² watts.
- All sound data listed by octave bands is raw data without any corrections for room absorption or duct attenuation. Dash (-) in space indicates sound power level is less than 20 dB or equal to background.
- Minimum inlet ΔPs is the minimum operating pressure requirement of the unit (damper full open) and the difference in static pressure from inlet to discharge of the unit.
- Asterisk (*) in space indicates that the minimum inlet static pressure requirement is greater than 0.5" w.g. (125 Pa) at rated airflow.
- Data derived from independent tests conducted in accordance with ANSI/ASHRAE Standard 130 and AHRI Standard 880.

Oversized Casing • Larger Hot Water Coils

Model: 31RW

Nailor oversized casing option utilizes a cabinet that is one size larger than the standard unit. This provides the ability to increase the size of the heating coil, compared to the standard unit. In applications where additional heating is required, using an oversized casing option can provide what is needed.

FEATURES:

- One, two, three and four row coils available.
- Hot water coils have copper tubes and aluminum ripple fins. Coils have 1/2" (13), 7/8" (22) or 1 3/8" (35) O.D. sweat connections.
- Right or left hand coil connection is determined by looking through the terminal inlet in the direction of airflow.
- Galvanized steel casing with slip and drive discharge duct connection.
- Optional low leakage gasketed access door is recommended for coil access and cleaning.
- AHRI Certified coils

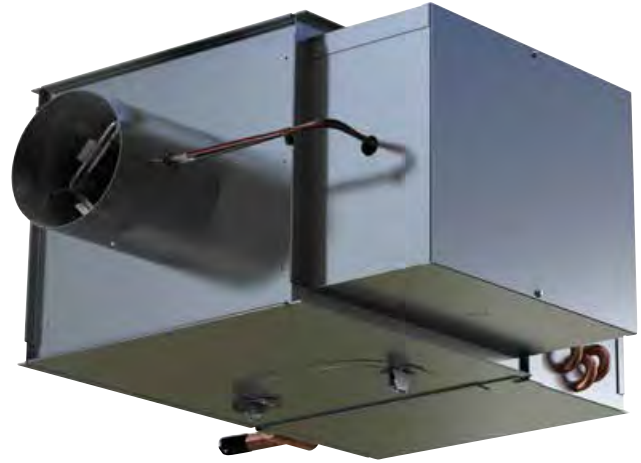

Model D31RW with Oversized Casing

- Coil Performance data on pages A92-A100
- Denotes inlet airflow direction
- Slip and drive cleat duct connection
- For special outlet sizes and arrangements, consult your Nailor representative.

Dimensions

Model 31RW • Hot Water Reheat Coil

Digital and Analog Electronic Controls

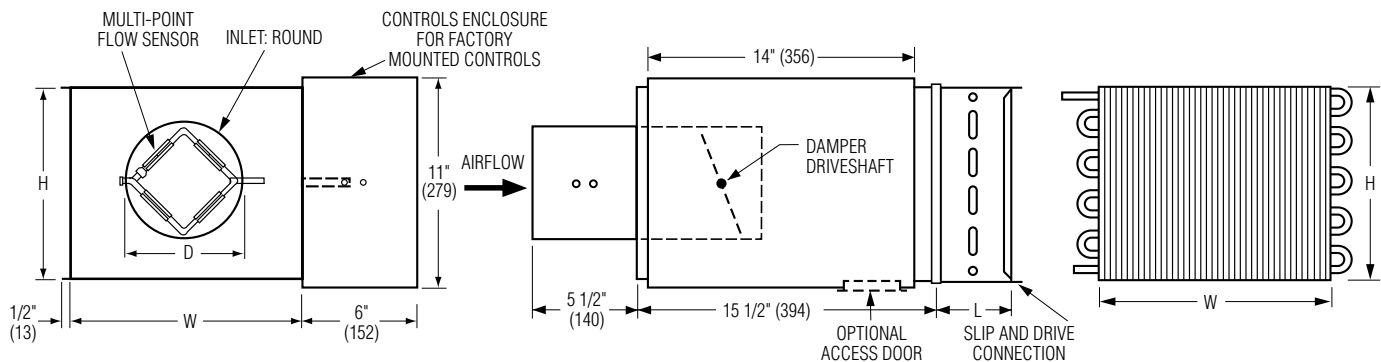

Digital and Analog Electronic Controls with Bottom Mount Controls location

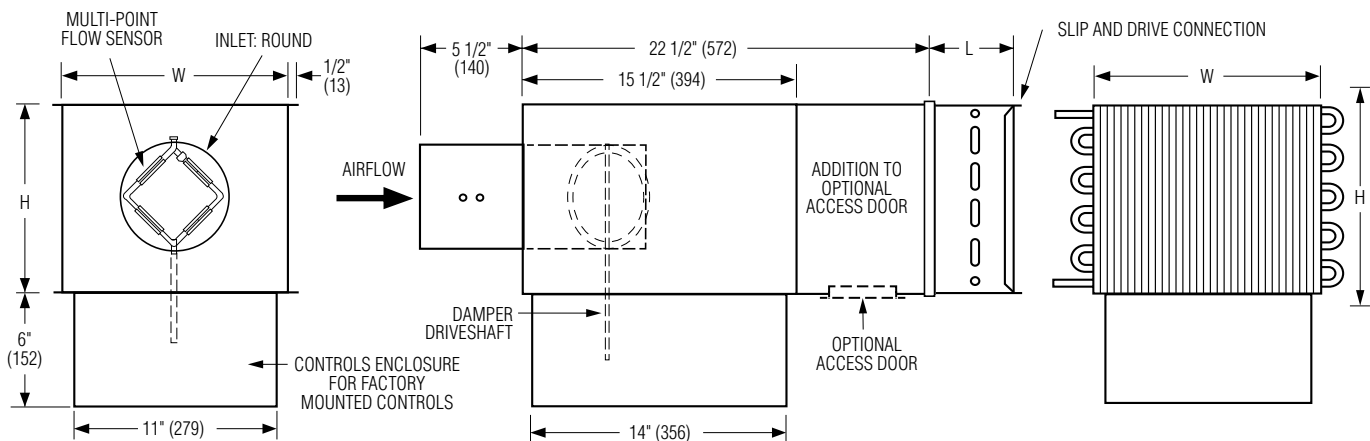

A

SINGLE DUCT TERMINAL UNITS

Dimensions • Oversized Casing with Larger Hot Water Coils

Model 31RW • Integral Attenuator plus Hot Water Reheat Coil

- All the benefits of both the Integral Sound Attenuator and the Hot Water Coils in one.
- Single continuous length terminal construction minimizes casing leakage.
- Continuous internal insulation reduces insulation seams and minimizes airflow disturbance.
- Supplied with same liner as basic unit.
- Coil performance data on pages A92-A100.

Digital and Analog Controls

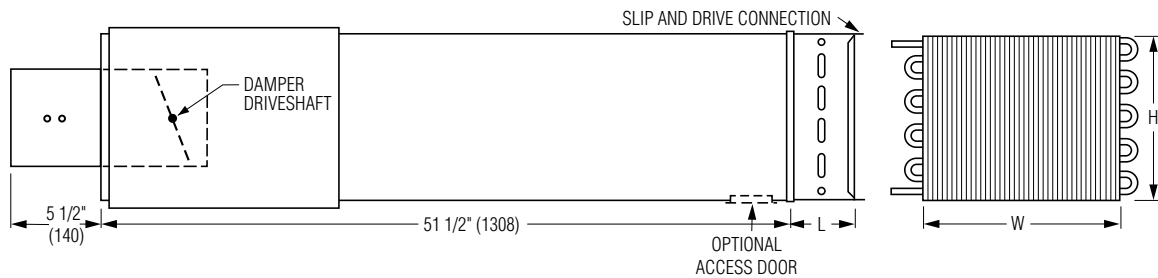

Digital and Analog Controls with Bottom Mount Controls Location

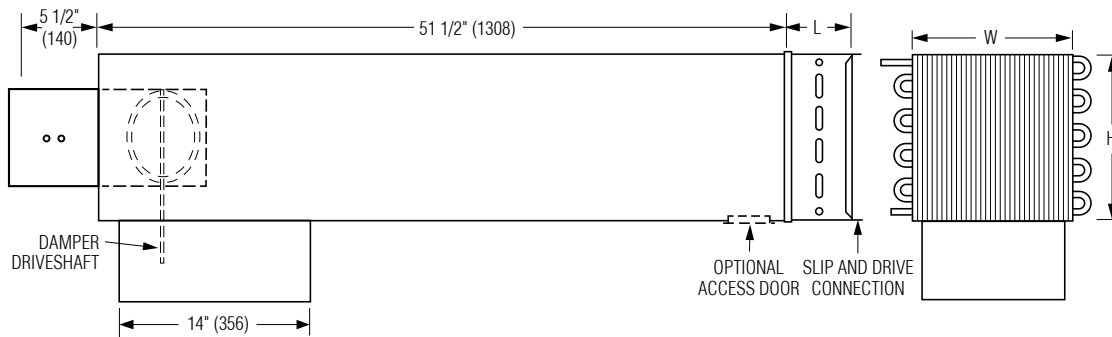

Dimensional Data

Unit Size	Inlet Size	Airflow Range, cfm (l/s) Digital*	W	H	Inlet Size (Nominal)	Coil Connections			
						1 Row	2 Row	3 Row	4 Row
8	4	0 – 225 (0 – 106)	12 (305)	10 (254)	3 7/8 (98) Round	1/2 (13)	7/8 (22)	7/8 (22)	7/8 (22)
	5	0 – 400 (0 – 189)			4 7/8 (124) Round	1/2 (13)	7/8 (22)	7/8 (22)	7/8 (22)
	6	0 – 550 (0 – 260)			5 7/8 (149) Round	1/2 (13)	7/8 (22)	7/8 (22)	7/8 (22)
10	7	0 – 800 (0 – 378)	14 (356)	12 1/2 (318)	6 7/8 (175) Round	1/2 (13)	7/8 (22)	7/8 (22)	7/8 (22)
	8	0 – 1100 (0 – 519)			7 7/8 (200) Round	1/2 (13)	7/8 (22)	7/8 (22)	7/8 (22)
12	9	0 – 1400 (0 – 661)	16 (406)	15 (381)	8 7/8 (225) Round	1/2 (13)	7/8 (22)	7/8 (22)	7/8 (22)
	10	0 – 1840 (0 – 868)			9 7/8 (251) Round	1/2 (13)	7/8 (22)	7/8 (22)	7/8 (22)
14	12	0 – 2500 (0 – 1180)	20 (508)	17 1/2 (508)	11 7/8 (302) Round	1/2 (13)	7/8 (22)	7/8 (22)	7/8 (22)
16	14	0 – 3370 (0 – 1590)	24 (610)	18 (457)	13 7/8 (352) Round	7/8 (22)	7/8 (22)	7/8 (22)	7/8 (22)
24	16	0 – 4510 (0 – 2128)	38 (965)	18 (457)	15 7/8 (403) Round	7/8 (22)	7/8 (22)	1 3/8 (35)	1 3/8 (35)

* Maximum airflow limit is based upon 1.5" w.g. (373 Pa) max. differential pressure signal from Diamond Flow Sensor..

Performance Data • Hot Water Coil • Capacities

Model: 31RW

Unit Sizes 4, 5 and 6

1 Row (single circuit)

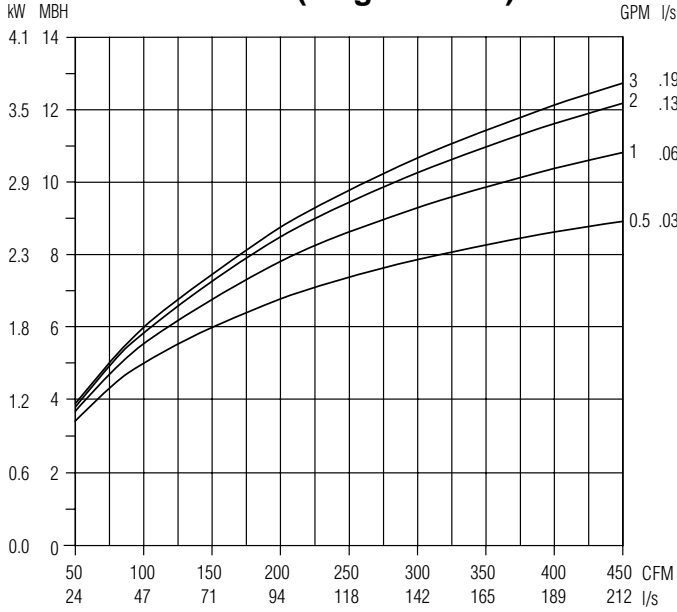

2 Row (multi-circuit)

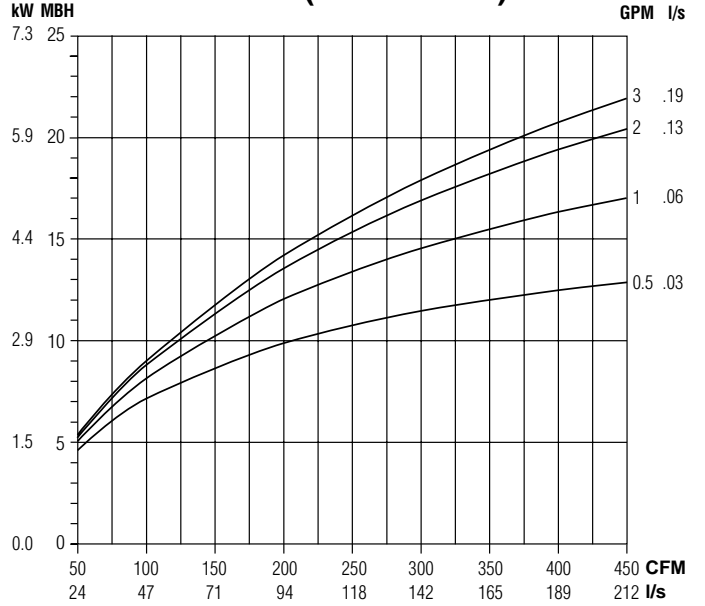

3 Row (multi-circuit)

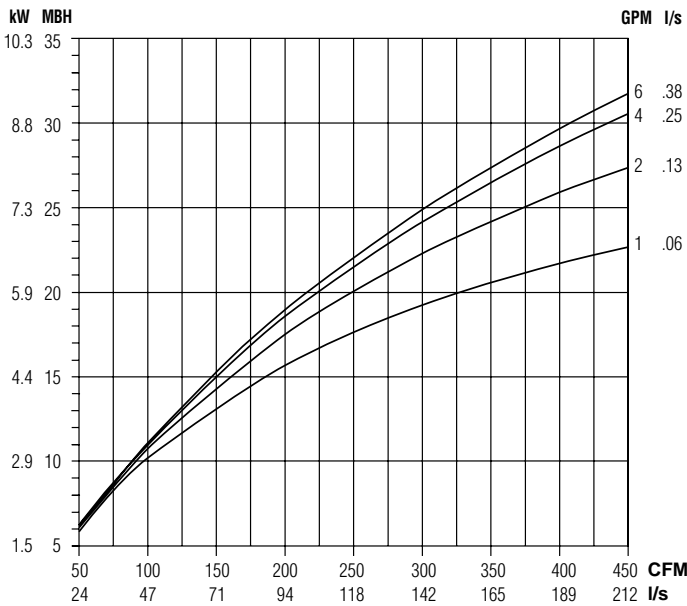

4 Row (multi-circuit)

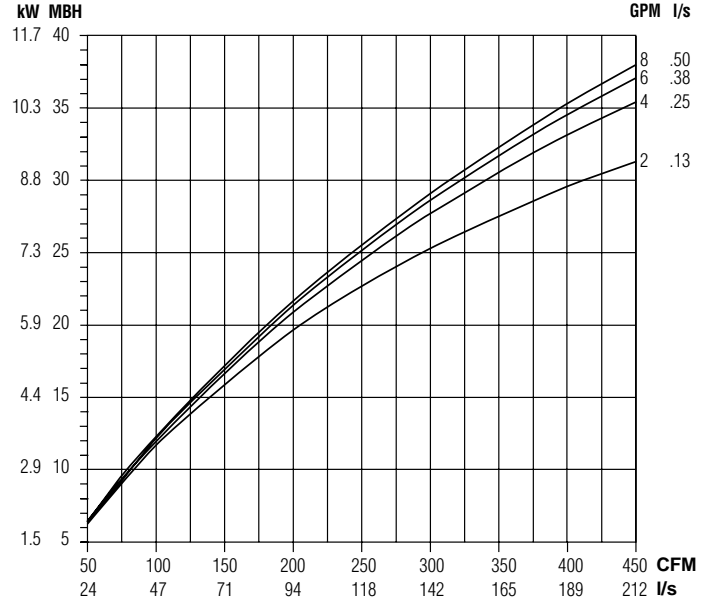

NOTES:

- Capacities are in MBH (kW), *thousands of Btu per hour (kiloWatts)*.
- MBH (kW) values are based on a Δt (temperature difference) of 125°F (69°C) between entering air and entering water. For other Δt 's; multiply the MBH (kW) values by the factors below.

- Air Temperature Rise.

$$\text{ATR (}^\circ\text{F)} = 927 \times \frac{\text{MBH}}{\text{cfm}}, \text{ ATR (}^\circ\text{C)} = 829 \times \frac{\text{kW}}{\text{l/s}}$$

- Water Temp. Drop.

$$\text{WTD (}^\circ\text{F)} = 2.04 \times \frac{\text{MBH}}{\text{GPM}}, \text{ WTD (}^\circ\text{C)} = .224 \times \frac{\text{kW}}{\text{l/s}}$$

- Connections: 1 Row 1/2" (13), 2, 3 and 4 Row 7/8" (22); O.D. male solder.

Altitude Correction Factors:

Altitude ft. (m)	Sensible Heat Factor
0 (0)	1.00
2000 (610)	0.94
3000 (914)	0.90
4000 (1219)	0.87
5000 (1524)	0.84
6000 (1829)	0.81
7000 (2134)	0.78

Correction factors at other entering conditions:

Δt °F (°C)	40 (22)	50 (28)	60 (33)	70 (39)	80 (44)	90 (50)	100 (56)	110 (61)	125 (69)	140 (78)	160 (89)	180 (100)
Factor	.320 (.319)	.400 (.406)	.480 (.478)	.560 (.565)	.640 (.638)	.720 (.725)	.800 (.812)	.880 (.884)	1.00 (1.00)	1.12 (1.13)	1.28 (1.29)	1.44 (1.45)

A

SINGLE DUCT TERMINAL UNITS

Performance Data • Hot Water Coil • Capacities

Model: 31RW

Unit Sizes 7 and 8

1 Row (single circuit)

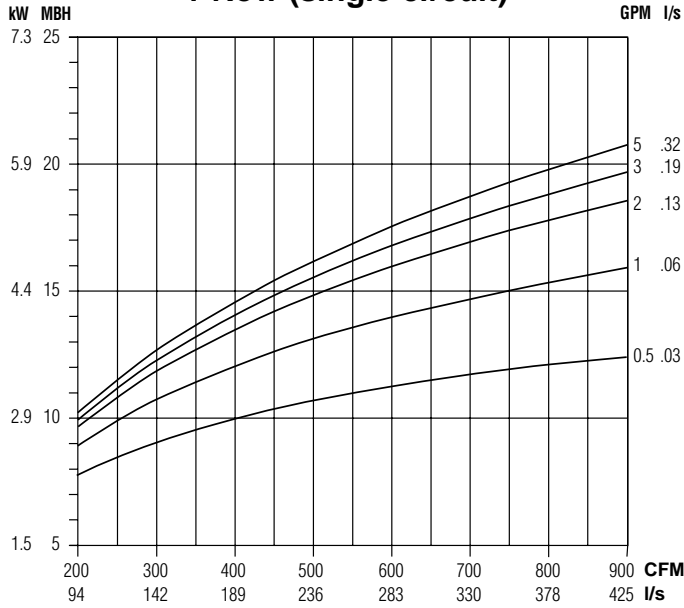

2 Row (multi-circuit)

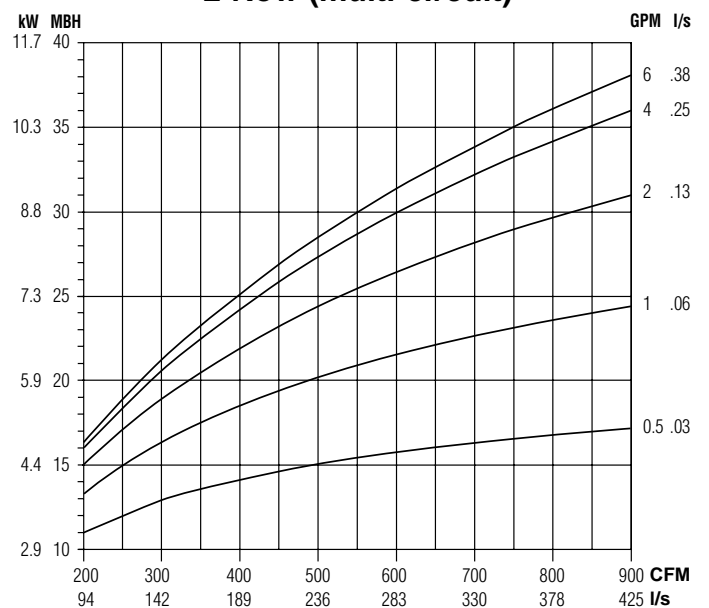

3 Row (multi-circuit)

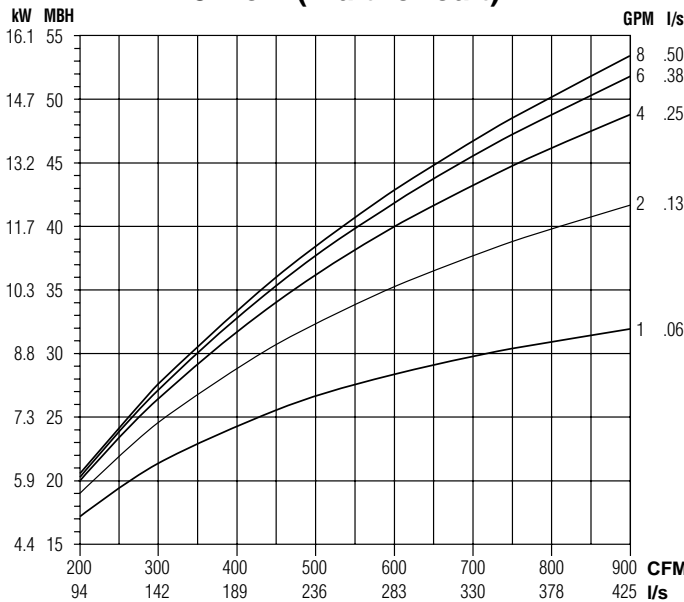

4 Row (multi-circuit)

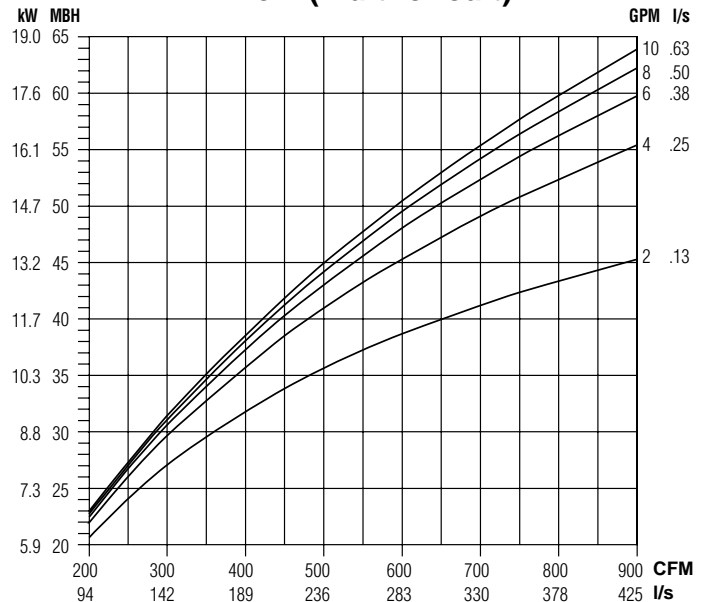

NOTES:

- Capacities are in MBH (kW), *thousands of Btu per hour (kiloWatts)*.
- MBH (kW) values are based on a Δt (temperature difference) of 125°F (69°C) between entering air and entering water. For other Δt 's; multiply the MBH (kW) values by the factors below.

- Air Temperature Rise.

$$\text{ATR (}^\circ\text{F)} = 927 \times \frac{\text{MBH}}{\text{cfm}}, \text{ ATR (}^\circ\text{C)} = 829 \times \frac{\text{kW}}{\text{l/s}}$$

- Water Temp. Drop.

$$\text{WTD (}^\circ\text{F)} = 2.04 \times \frac{\text{MBH}}{\text{GPM}}, \text{ WTD (}^\circ\text{C)} = .224 \times \frac{\text{kW}}{\text{l/s}}$$

- Connections: 1 Row 1/2" (13), 2, 3 and 4 Row 7/8" (22); O.D. male solder.

Altitude Correction Factors:

Altitude ft. (m)	Sensible Heat Factor
0 (0)	1.00
2000 (610)	0.94
3000 (914)	0.90
4000 (1219)	0.87
5000 (1524)	0.84
6000 (1829)	0.81
7000 (2134)	0.78

Correction factors at other entering conditions:

Δt °F (°C)	40 (22)	50 (28)	60 (33)	70 (39)	80 (44)	90 (50)	100 (56)	110 (61)	125 (69)	140 (78)	160 (89)	180 (100)
Factor	.320 (.319)	.400 (.406)	.480 (.478)	.560 (.565)	.640 (.638)	.720 (.725)	.800 (.812)	.880 (.884)	1.00 (1.00)	1.12 (1.13)	1.28 (1.29)	1.44 (1.45)

Performance Data • Hot Water Coil • Capacities

Model: 31RW

Unit Sizes 9 and 10

SINGLE DUCT TERMINAL UNITS

1 Row (single circuit)

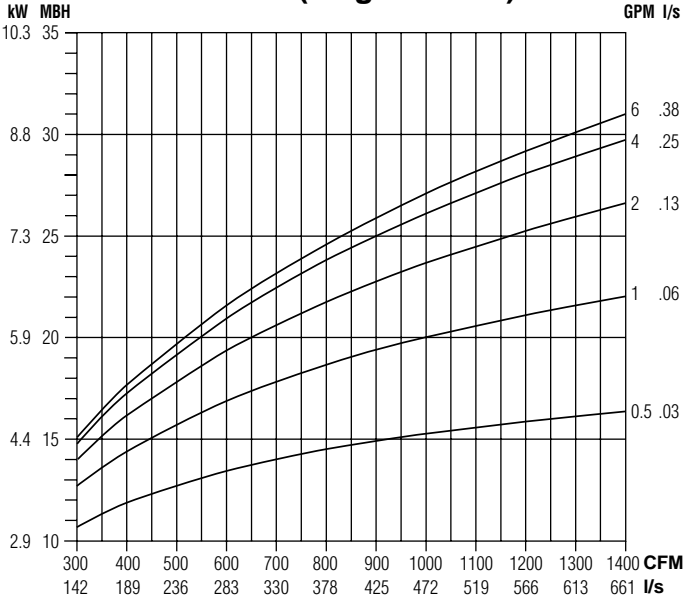

2 Row (multi-circuit)

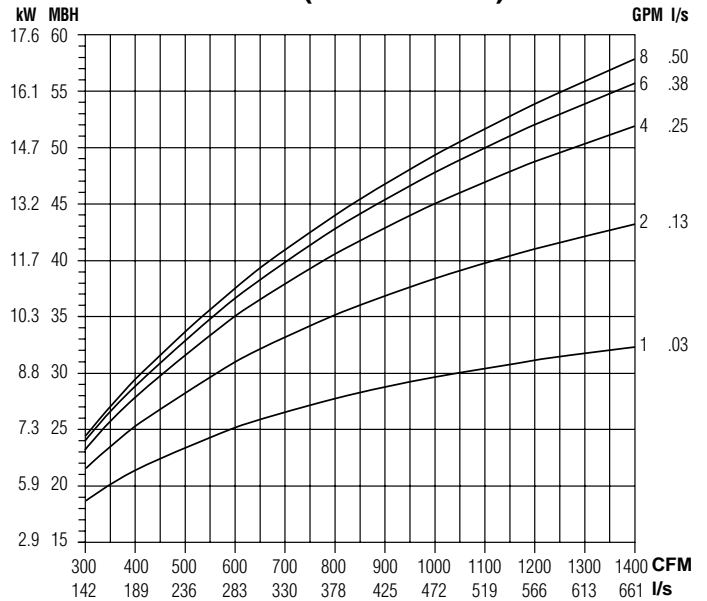

3 Row (multi-circuit)

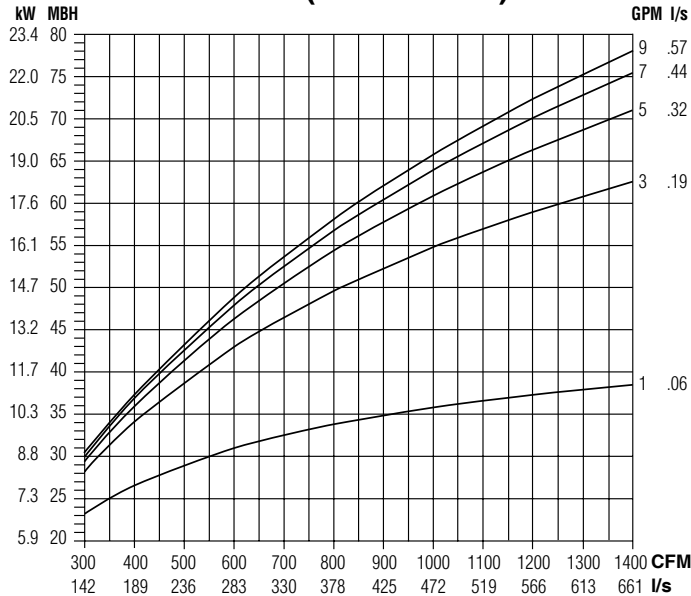

4 Row (multi-circuit)

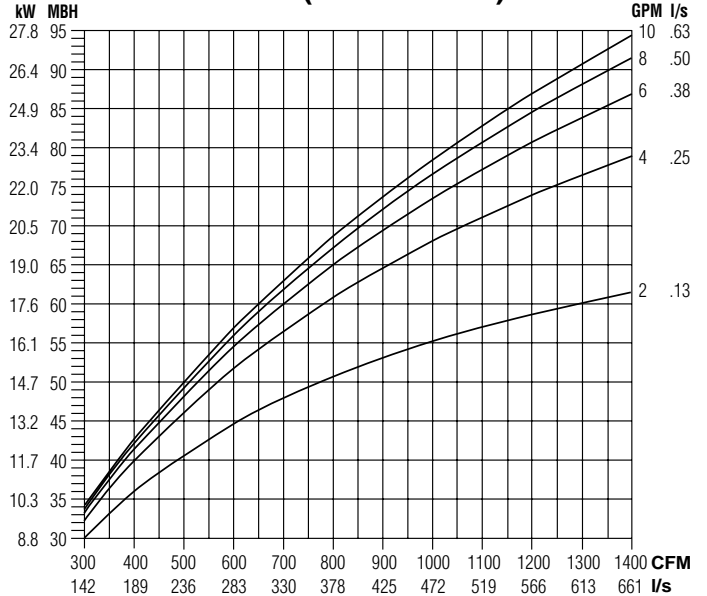

NOTES:

- Capacities are in MBH (kW), *thousands of Btu per hour (kiloWatts)*.
- MBH (kW) values are based on a Δt (temperature difference) of 125°F (69°C) between entering air and entering water. For other Δt 's; multiply the MBH (kW) values by the factors below.

- Air Temperature Rise.
 $ATR (^\circ F) = 927 \times \frac{MBH}{cfm}$, $ATR (^\circ C) = 829 \times \frac{kW}{l/s}$
- Water Temp. Drop.
 $WTD (^\circ F) = 2.04 \times \frac{MBH}{GPM}$, $WTD (^\circ C) = .224 \times \frac{kW}{l/s}$
- Connections: 1 Row 1/2" (13), 2, 3 and 4 Row 7/8" (22); O.D. male solder.

Altitude Correction Factors:

Altitude ft. (m)	Sensible Heat Factor
0 (0)	1.00
2000 (610)	0.94
3000 (914)	0.90
4000 (1219)	0.87
5000 (1524)	0.84
6000 (1829)	0.81
7000 (2134)	0.78

Correction factors at other entering conditions:

Δt °F (°C)	40 (22)	50 (28)	60 (33)	70 (39)	80 (44)	90 (50)	100 (56)	110 (61)	125 (69)	140 (78)	160 (89)	180 (100)
Factor	.320 (.319)	.400 (.406)	.480 (.478)	.560 (.565)	.640 (.638)	.720 (.725)	.800 (.812)	.880 (.884)	1.00 (1.00)	1.12 (1.13)	1.28 (1.29)	1.44 (1.45)

Performance Data • Hot Water Coil • Capacities

Model: 31RW

Unit Size 12

1 Row (single circuit)

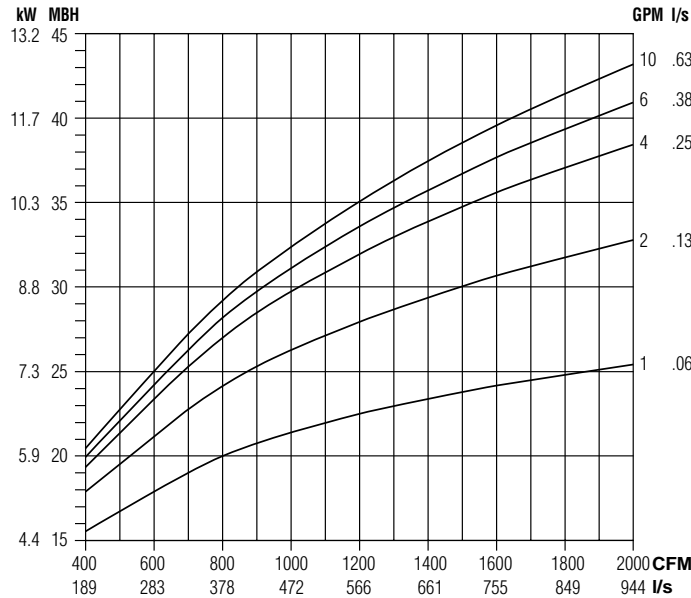

2 Row (multi-circuit)

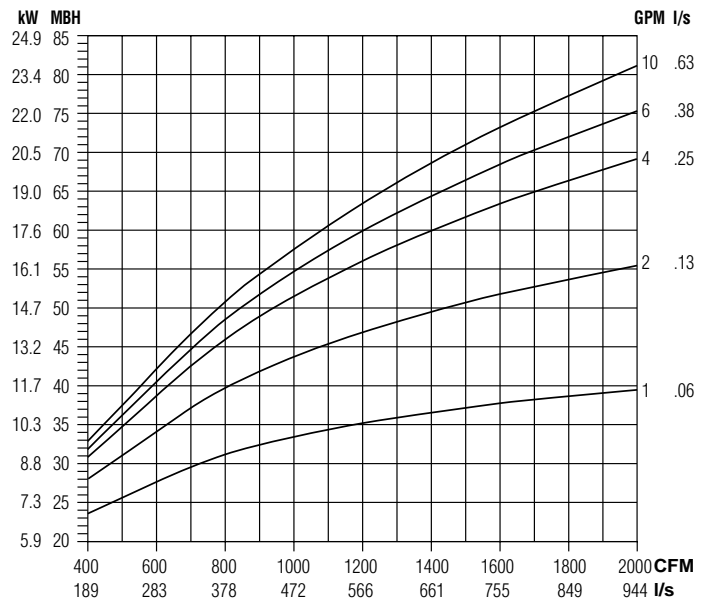

3 Row (multi-circuit)

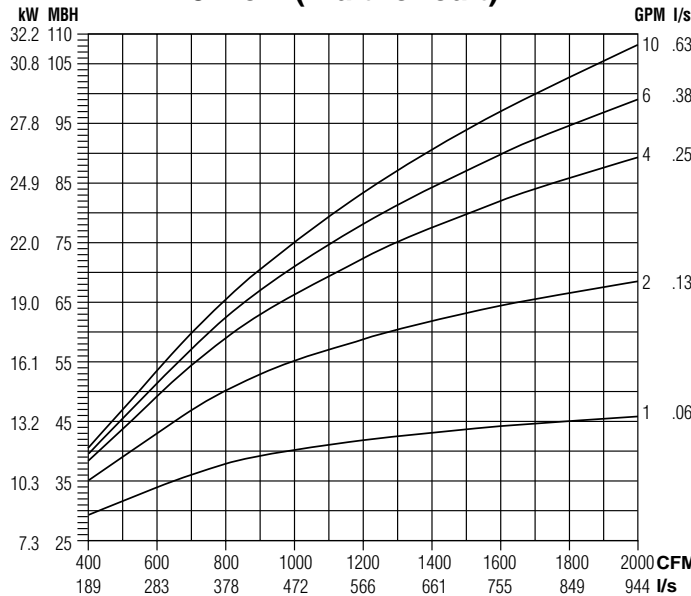

4 Row (multi-circuit)

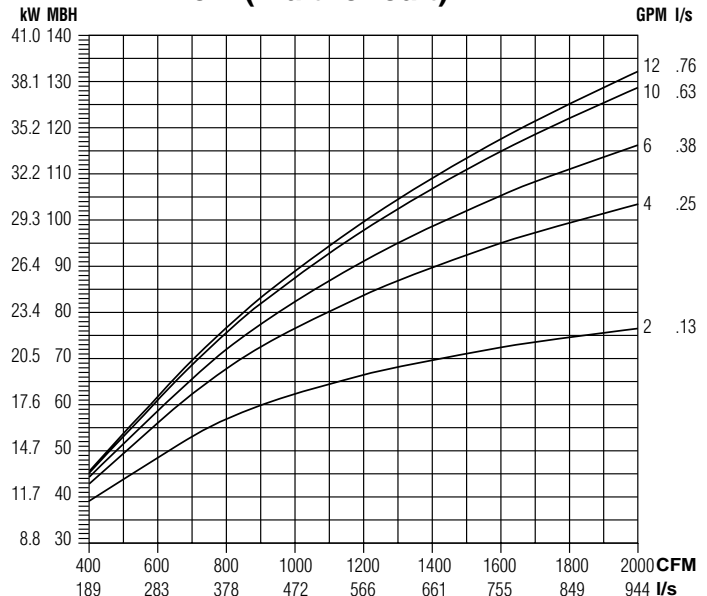

NOTES:

- Capacities are in MBH (kW), *thousands of Btu per hour (kiloWatts)*.
- MBH (kW) values are based on a Δt (temperature difference) of 125°F (69°C) between entering air and entering water. For other Δt 's; multiply the MBH (kW) values by the factors below.

- Air Temperature Rise.
 $ATR (^\circ F) = 927 \times \frac{MBH}{cfm}$, $ATR (^\circ C) = 829 \times \frac{kW}{l/s}$
- Water Temp. Drop.
 $WTD (^\circ F) = 2.04 \times \frac{MBH}{GPM}$, $WTD (^\circ C) = .224 \times \frac{kW}{l/s}$
- Connections: 1 Row 1/2" (13), 2, 3 and 4 Row 7/8" (22); O.D. male solder.

Altitude Correction Factors:

Altitude ft. (m)	Sensible Heat Factor
0 (0)	1.00
2000 (610)	0.94
3000 (914)	0.90
4000 (1219)	0.87
5000 (1524)	0.84
6000 (1829)	0.81
7000 (2134)	0.78

Correction factors at other entering conditions:

Δt °F (°C)	40 (22)	50 (28)	60 (33)	70 (39)	80 (44)	90 (50)	100 (56)	110 (61)	125 (69)	140 (78)	160 (89)	180 (100)
Factor	.320 (.319)	.400 (.406)	.480 (.478)	.560 (.565)	.640 (.638)	.720 (.725)	.800 (.812)	.880 (.884)	1.00 (1.00)	1.12 (1.13)	1.28 (1.29)	1.44 (1.45)

Performance Data • Hot Water Coil • Capacities

Model: 31RW

Unit Size 14

1 Row (single circuit)

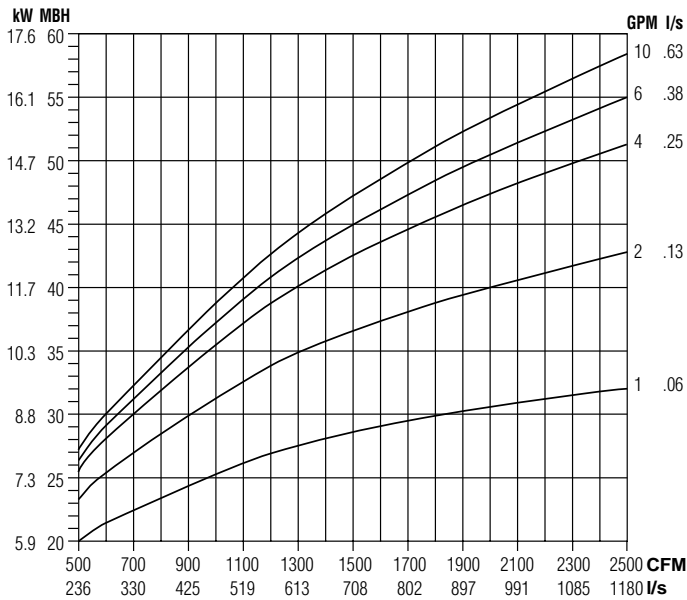

2 Row (multi-circuit)

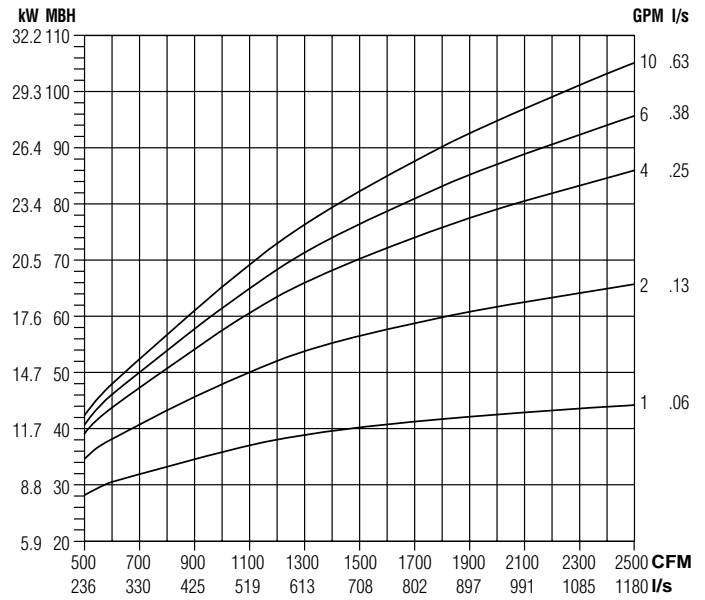

3 Row (multi-circuit)

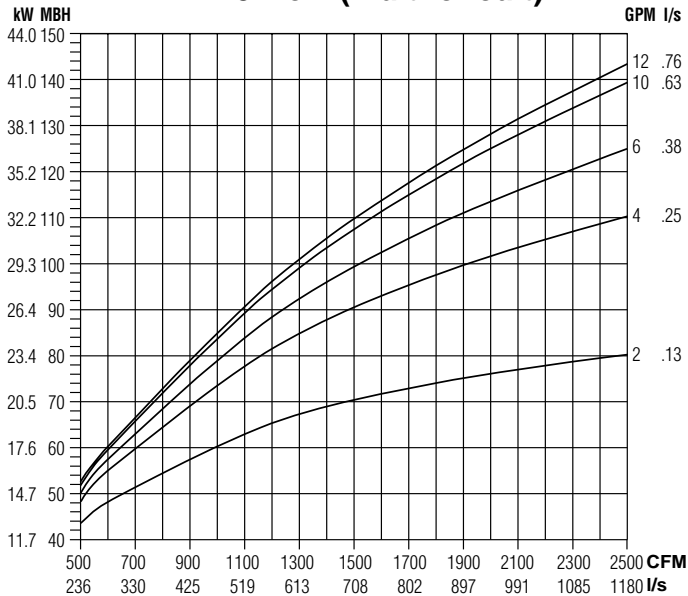

4 Row (multi-circuit)

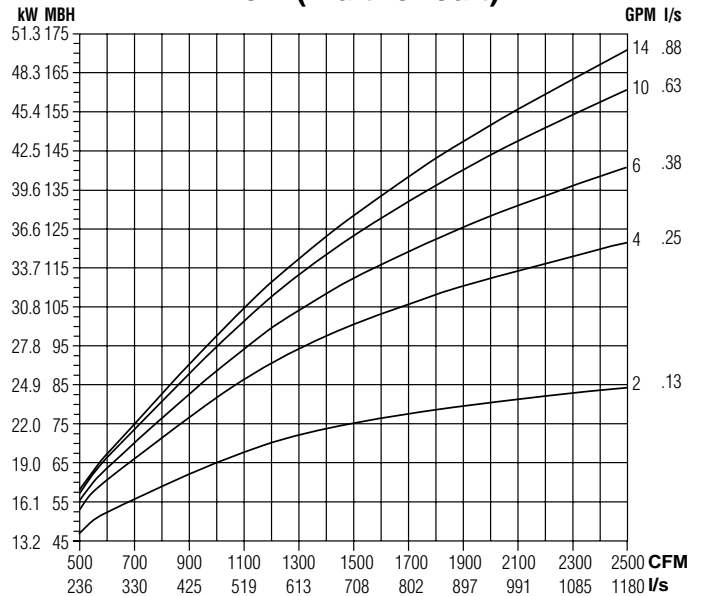

NOTES:

- Capacities are in MBH (kW), *thousands of Btu per hour (kiloWatts)*.
- MBH (kW) values are based on a Δt (temperature difference) of 125°F (69°C) between entering air and entering water. For other Δt 's; multiply the MBH (kW) values by the factors below.

- Air Temperature Rise.

$$\text{ATR (}^\circ\text{F)} = 927 \times \frac{\text{MBH}}{\text{cfm}}, \text{ ATR (}^\circ\text{C)} = 829 \times \frac{\text{kW}}{\text{l/s}}$$

- Water Temp. Drop.

$$\text{WTD (}^\circ\text{F)} = 2.04 \times \frac{\text{MBH}}{\text{GPM}}, \text{ WTD (}^\circ\text{C)} = .224 \times \frac{\text{kW}}{\text{l/s}}$$

- Connections: 1 Row 1/2" (13), 2, 3 and 4 Row 7/8" (22); O.D. male solder.

Altitude Correction Factors:

Altitude ft. (m)	Sensible Heat Factor
0 (0)	1.00
2000 (610)	0.94
3000 (914)	0.90
4000 (1219)	0.87
5000 (1524)	0.84
6000 (1829)	0.81
7000 (2134)	0.78

Correction factors at other entering conditions:

Δt °F (°C)	40 (22)	50 (28)	60 (33)	70 (39)	80 (44)	90 (50)	100 (56)	110 (61)	125 (69)	140 (78)	160 (89)	180 (100)
Factor	.320 (.319)	.400 (.406)	.480 (.478)	.560 (.565)	.640 (.638)	.720 (.725)	.800 (.812)	.880 (.884)	1.00 (1.00)	1.12 (1.13)	1.28 (1.29)	1.44 (1.45)

A SINGLE DUCT TERMINAL UNITS

Performance Data • Hot Water Coil • Capacities

Model: 31RW

Unit Size 16

1 Row (single circuit)

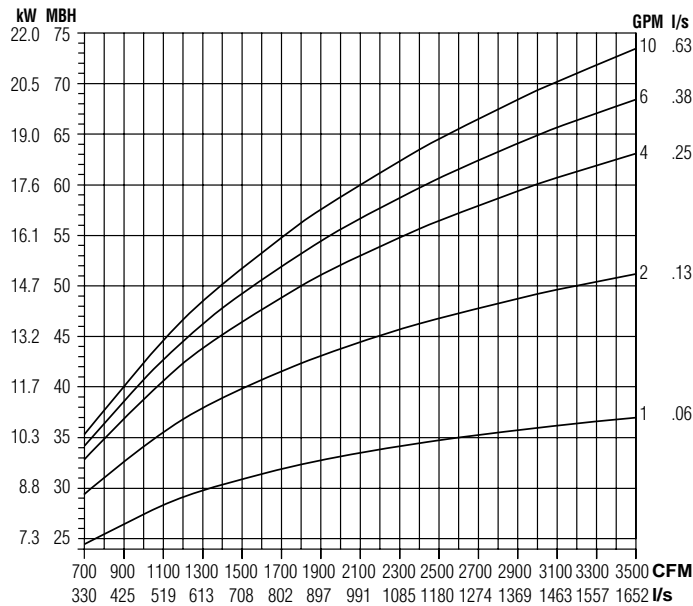

2 Row (multi-circuit)

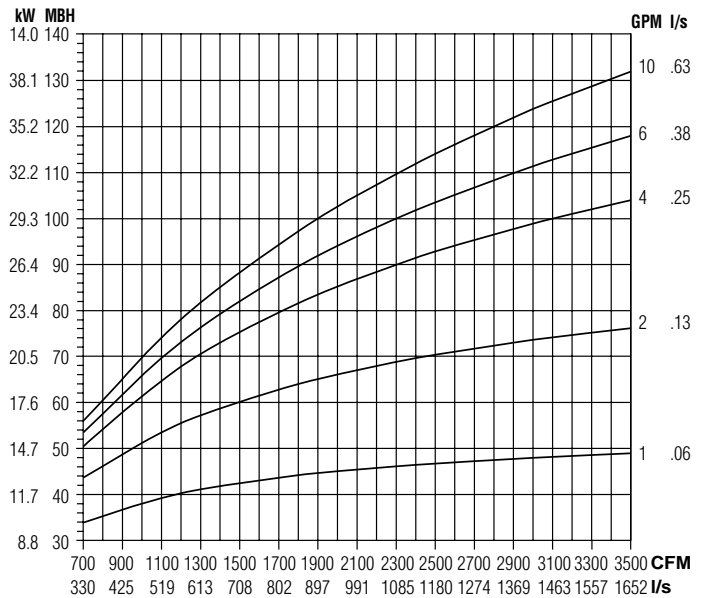

3 Row (multi-circuit)

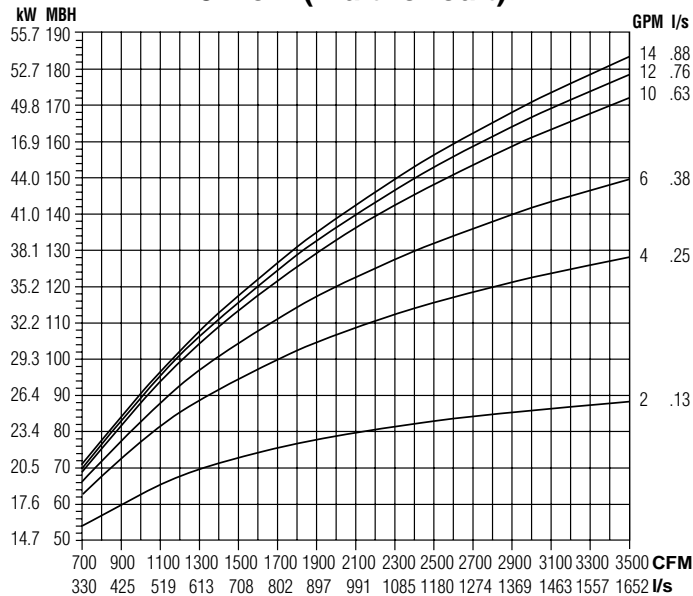

4 Row (multi-circuit)

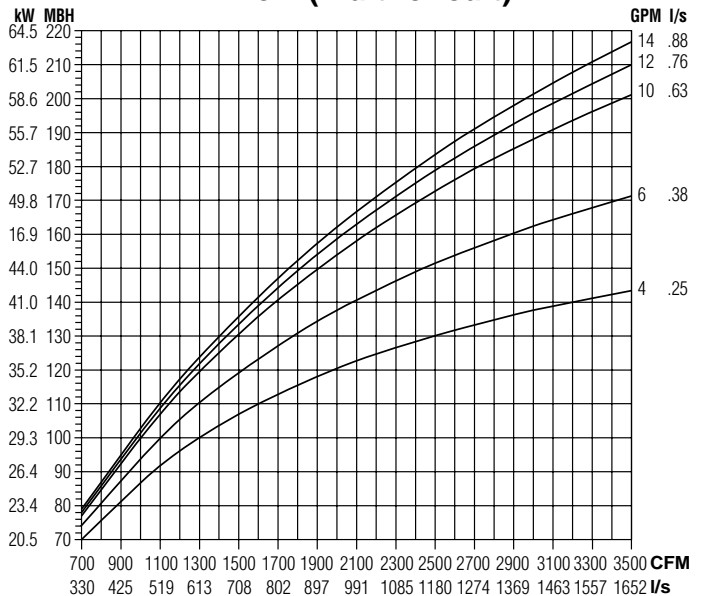

NOTES:

- Capacities are in MBH (kW), *thousands of Btu per hour (kiloWatts)*.
- MBH (kW) values are based on a Δt (temperature difference) of 125°F (69°C) between entering air and entering water. For other Δt 's; multiply the MBH (kW) values by the factors below.

- Air Temperature Rise.

$$\text{ATR (}^\circ\text{F)} = 927 \times \frac{\text{MBH}}{\text{cfm}}, \text{ ATR (}^\circ\text{C)} = 829 \times \frac{\text{kW}}{\text{l/s}}$$

- Water Temp. Drop.

$$\text{WTD (}^\circ\text{F)} = 2.04 \times \frac{\text{MBH}}{\text{GPM}}, \text{ WTD (}^\circ\text{C)} = .224 \times \frac{\text{kW}}{\text{l/s}}$$

- Connections: 1, 2, 3 and 4 Row 7/8" (22); O.D. male solder.

Altitude Correction Factors:

Altitude ft. (m)	Sensible Heat Factor
0 (0)	1.00
2000 (610)	0.94
3000 (914)	0.90
4000 (1219)	0.87
5000 (1524)	0.84
6000 (1829)	0.81
7000 (2134)	0.78

Correction factors at other entering conditions:

Δt °F (°C)	40 (22)	50 (28)	60 (33)	70 (39)	80 (44)	90 (50)	100 (56)	110 (61)	125 (69)	140 (78)	160 (89)	180 (100)
Factor	.320 (.319)	.400 (.406)	.480 (.478)	.560 (.565)	.640 (.638)	.720 (.725)	.800 (.812)	.880 (.884)	1.00 (1.00)	1.12 (1.13)	1.28 (1.29)	1.44 (1.45)

Performance Data • Hot Water Coil • Capacities

Model: 31RW

Unit Size 24 x 16

1 Row (single circuit)

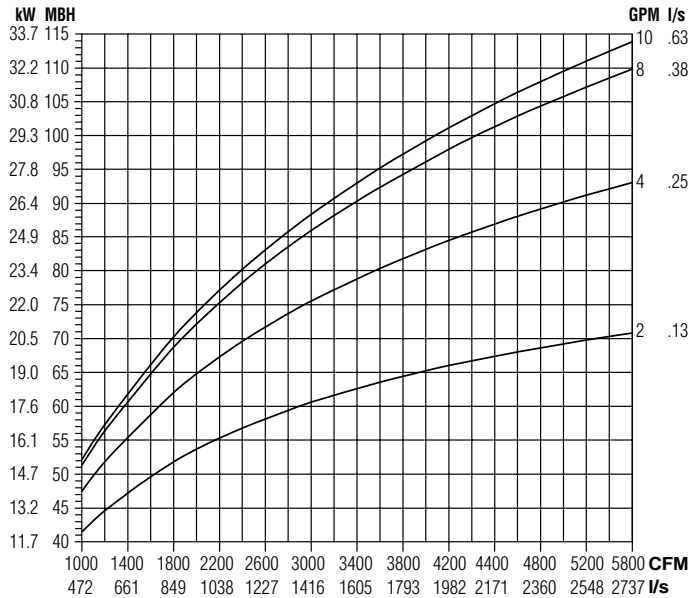

2 Row (multi-circuit)

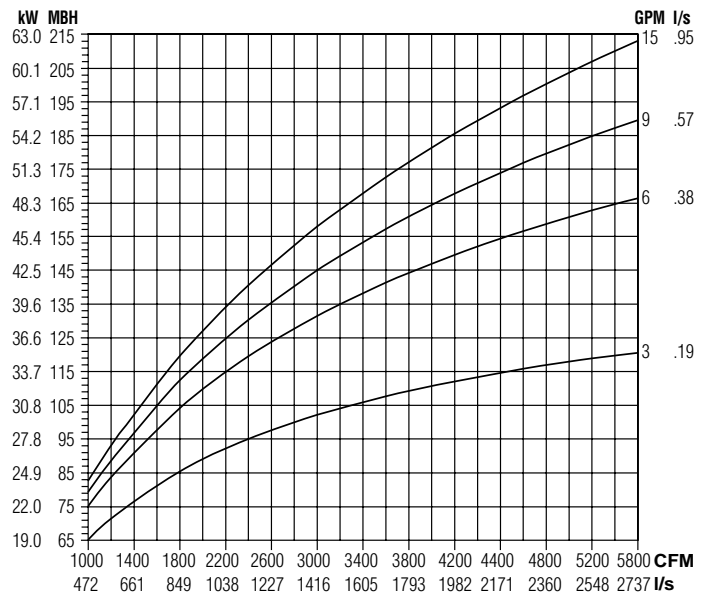

3 Row (multi-circuit)

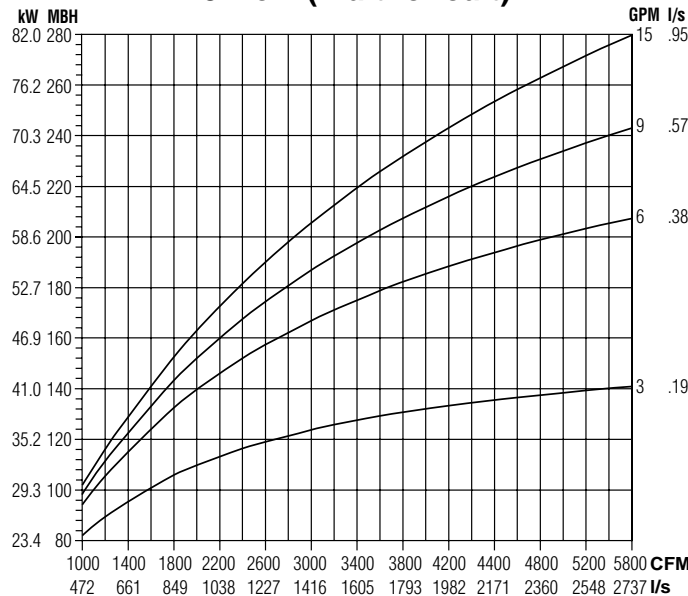

4 Row (multi-circuit)

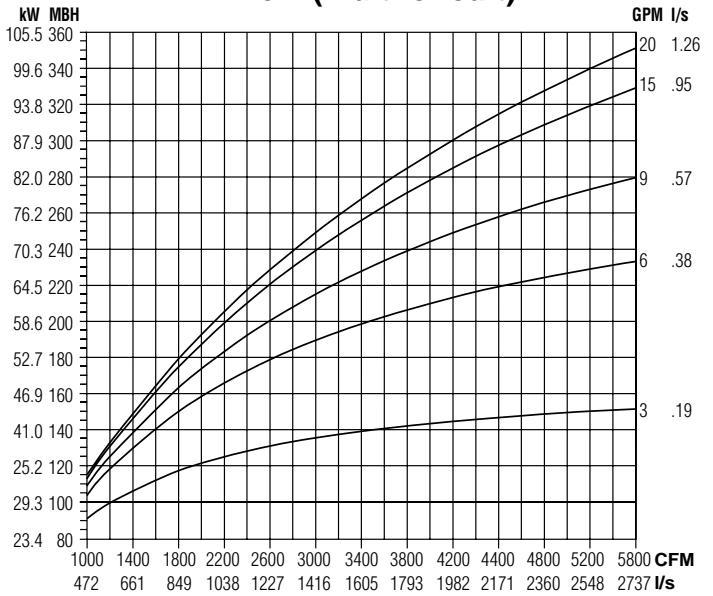

NOTES:

- Capacities are in MBH (kW), *thousands of Btu per hour (kiloWatts)*.
- MBH (kW) values are based on a Δt (temperature difference) of 125°F (69°C) between entering air and entering water. For other Δt 's; multiply the MBH (kW) values by the factors below.

- Air Temperature Rise.
 $ATR (^\circ F) = 927 \times \frac{MBH}{cfm}$, $ATR (^\circ C) = 829 \times \frac{kW}{l/s}$
- Water Temp. Drop.
 $WTD (^\circ F) = 2.04 \times \frac{MBH}{GPM}$, $WTD (^\circ C) = .224 \times \frac{kW}{l/s}$
- Connections: 1 and 2 Row 7/8" (22), 3 and 4 Row 1 3/8" (35); O.D. male solder.

Altitude Correction Factors:

Altitude ft. (m)	Sensible Heat Factor
0 (0)	1.00
2000 (610)	0.94
3000 (914)	0.90
4000 (1219)	0.87
5000 (1524)	0.84
6000 (1829)	0.81
7000 (2134)	0.78

Correction factors at other entering conditions:

Δt °F (°C)	40 (22)	50 (28)	60 (33)	70 (39)	80 (44)	90 (50)	100 (56)	110 (61)	125 (69)	140 (78)	160 (89)	180 (100)
Factor	.320 (.319)	.400 (.406)	.480 (.478)	.560 (.565)	.640 (.638)	.720 (.725)	.800 (.812)	.880 (.884)	1.00 (1.00)	1.12 (1.13)	1.28 (1.29)	1.44 (1.45)

A SINGLE DUCT TERMINAL UNITS

Performance Data • Hot Water Coil • Pressure Drop

Model: 31RW

Unit Sizes 4, 5 & 6

Unit Sizes 7 & 8

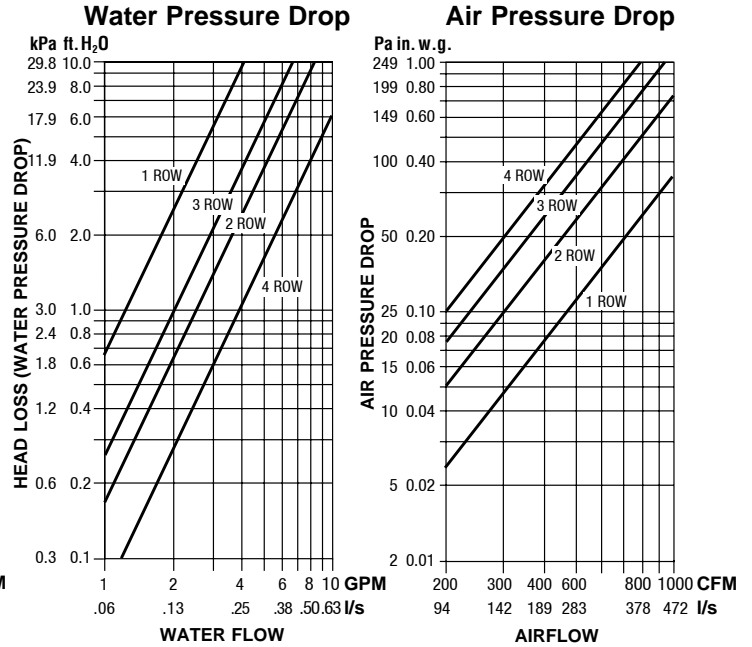
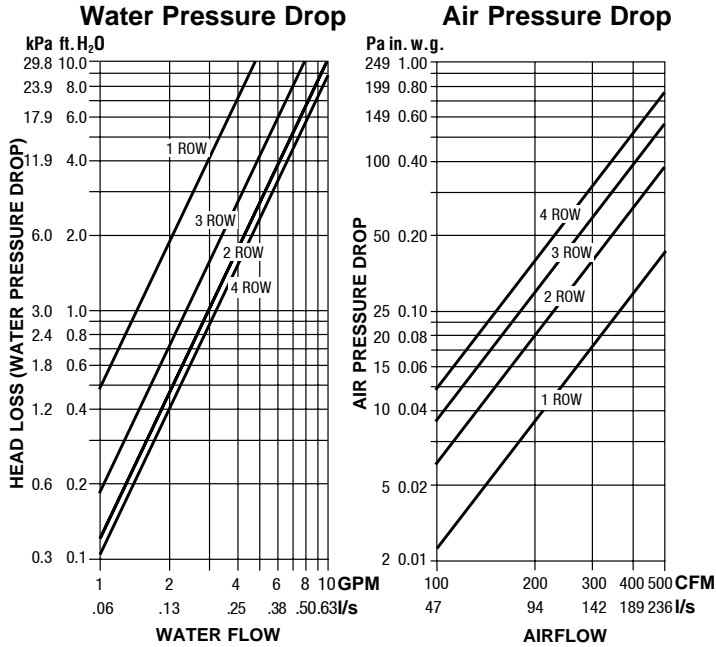

Unit Sizes 9 & 10

Unit Size 12

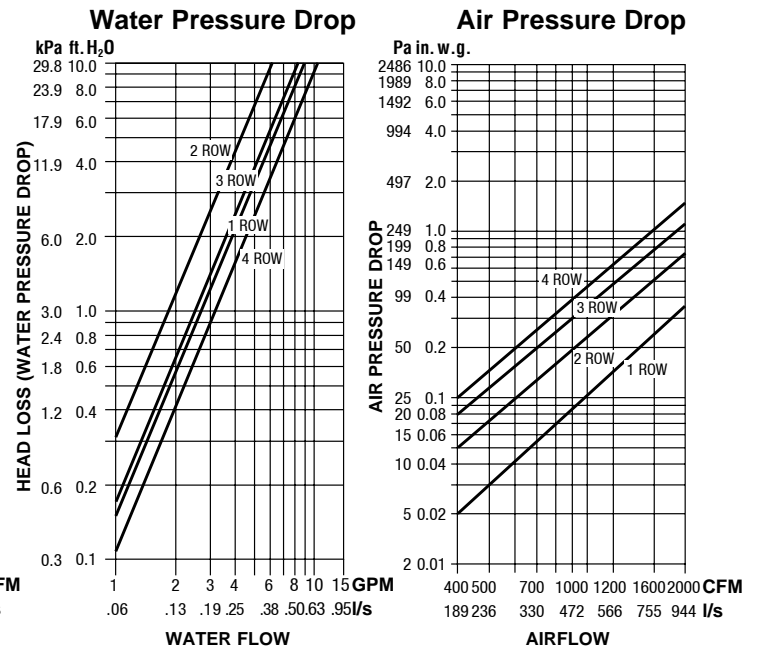
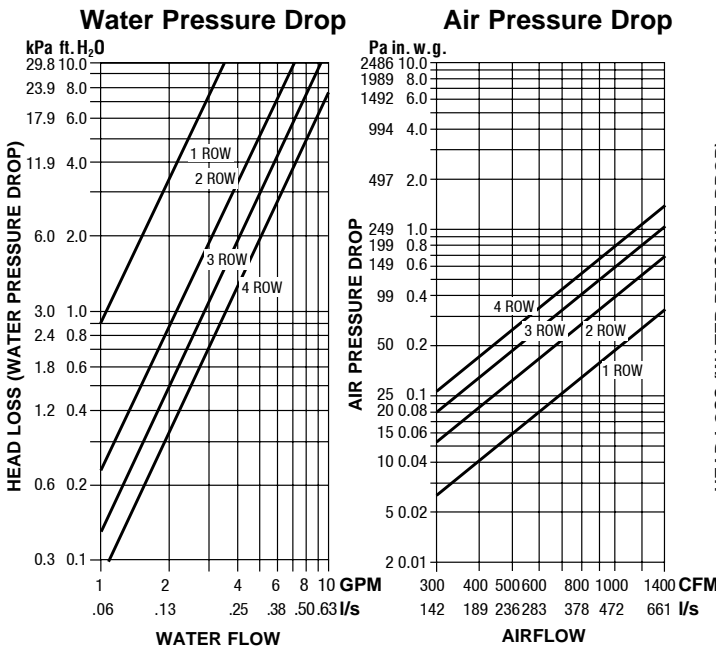

NOTES:

- Capacities are in MBH (kW), **thousands of Btu per hour (kiloWatts)**.
- MBH (kW) values are based on a Δt (temperature difference) of 125°F (69°C) between entering air and entering water. For other Δt 's; multiply the MBH (kW) values by the factors below.

- Air Temperature Rise.
 $ATR (^\circ F) = 927 \times \frac{MBH}{cfm}$, $ATR (^\circ C) = 829 \times \frac{kW}{l/s}$
- Water Temp. Drop.
 $WTD (^\circ F) = 2.04 \times \frac{MBH}{GPM}$, $WTD (^\circ C) = .224 \times \frac{kW}{l/s}$

Performance Data • Hot Water Coil • Pressure Drop

Model: 31RW

Unit Size 14

Unit Size 16

SINGLE DUCT TERMINAL UNITS

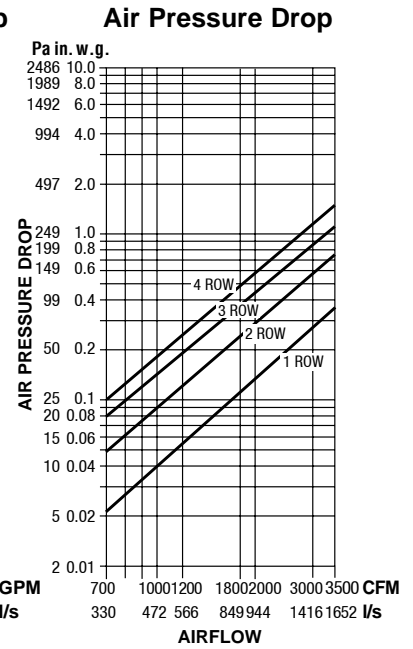
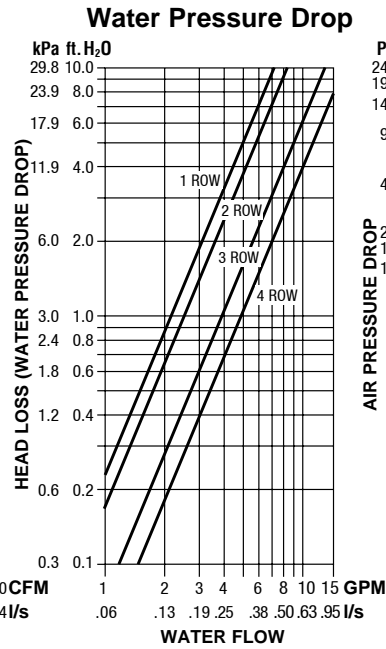
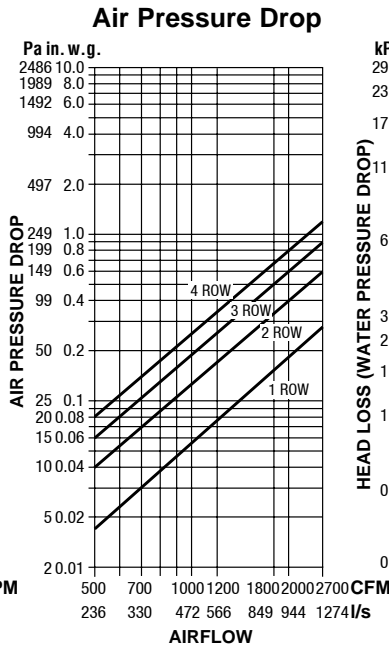
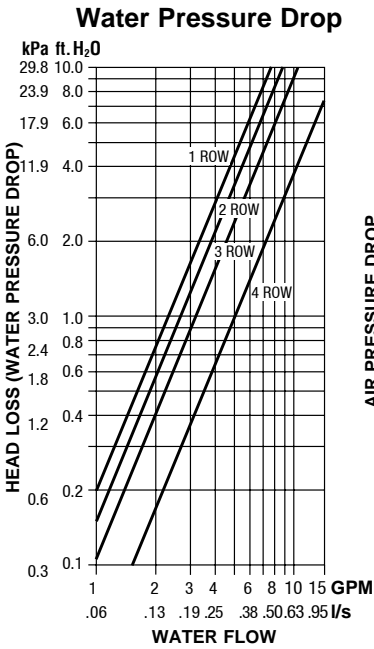

Unit Size 24 x 16

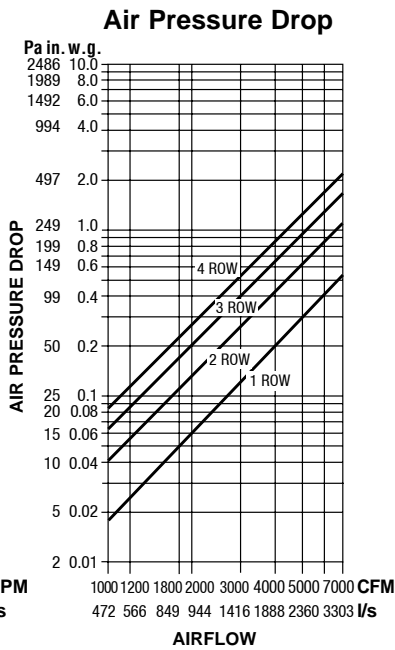
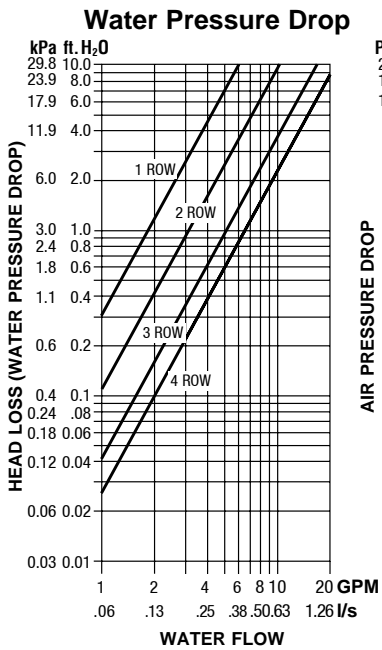

NOTES:

- Capacities are in MBH (kW), **thousands of Btu per hour (kiloWatts)**.
- MBH (kW) values are based on a Δt (temperature difference) of 125°F (69°C) between entering air and entering water. For other Δt 's; multiply the MBH (kW) values by the factors below.

- Air Temperature Rise.

$$ATR (^\circ F) = 927 \times \frac{MBH}{cfm}, \quad ATR (^\circ C) = 829 \times \frac{kW}{I/s}$$
- Water Temp. Drop.

$$WTD (^\circ F) = 2.04 \times \frac{MBH}{GPM}, \quad WTD (^\circ C) = .224 \times \frac{kW}{I/s}$$

Performance Data Explanation

Sound Power Levels vs. NC Levels

The **Nailor 3000, 3000Q, 30HQ, 30X, 30HQX and 3100 Series** single duct terminal unit performance data is presented in two forms (where applicable).

The laboratory obtained discharge and radiated sound power levels in octave bands 2 through 7 (125 through 4000 Hz) center frequency for each unit size at various flow rates and inlet static pressures is presented. This data is derived in accordance with ANSI/ASHRAE Standard 130 and AHRI Standard 880. This data is raw with no attenuation deductions and includes AHRI Certification standard rating points.

Nailor also provides an NC Level table as an application aid in terminal selection, which includes attenuation allowances as explained below. The suggested attenuation allowances are not representative of specific job site conditions. It is recommended that the sound power level data be used and a detailed NC calculation be performed using the procedures outlined in AHRI Standard 885, Appendix E for accurate space sound levels.

Explanation of NC Levels

Tabulated NC levels are based on attenuation values as outlined in AHRI Standard 885 "Procedure for Estimating Occupied Space Sound Levels in the Application of Air Terminals and Air Outlets". AHRI Standard 885, Appendix E provides typical sound attenuation values for air terminal discharge sound and air terminal radiated sound.

As stated in AHRI Standard 885, Appendix E, "These values can be used as a quick method of estimating space sound levels when a detailed evaluation is not available. The attenuation values are required for use by manufacturers to catalog application sound levels. In product catalogs, the end user environments are not known and the following factors are provided as typical attenuation values. Use of these values will allow better comparison between manufacturers and give the end user a value which will be expected to be applicable for many types of space."

Radiated Sound

Table E1 of Appendix E provides radiated sound attenuation values for three types of ceiling: Type 1 – Glass Fiber; Type 2 – Mineral Fiber; Type 3 – Solid Gypsum Board.

Since Mineral Fiber tile ceilings are the most common construction used in commercial buildings, these values have been used to tabulate Radiated NC levels.

The following table provides the calculation method for the radiated sound total attenuation values based on AHRI Standard 885.

	Octave Band					
	2	3	4	5	6	7
Environmental Effect	2	1	0	0	0	0
Ceiling/Space Effect	16	18	20	26	31	36
Total Attenuation Deduction	18	19	20	26	31	36

The ceiling/space effect assumes the following conditions:

1. 5/8" (16) tile, 20 lb/ft³ (320 kg/m³) density.
2. The plenum is at least 3 feet (914) deep.
3. The plenum space is either wide [over 30 feet (9 m)] or lined with insulation.
4. The ceiling has no significant penetration directly under the unit.

Discharge Sound

Table E1 of Appendix E provides typical discharge sound attenuation values for three sizes of terminal unit.

1. Small box: Less than 300 cfm (142 l/s)
[Discharge Duct 8" x 8" (203 x 203)].
2. Medium box: 300 – 700 cfm (142 - 330 l/s)
[Discharge Duct 12" x 12" (305 x 305)].
3. Large box: Greater than 700 cfm (330 l/s)
[Discharge Duct 15" x 15" (381 x 381)].

These attenuation values have been used to tabulate Discharge NC levels applied against the terminal airflow volume and not terminal unit size.

The following tables provide the calculation method for the discharge sound total attenuation values based on AHRI Standard 885.

Small Box <300 cfm	Octave Band					
	2	3	4	5	6	7
Environmental Effect	2	1	0	0	0	0
5 ft. (1.5 m) 1" (25) Duct Lining	2	6	12	25	29	18
Branch Power Division (1 outlet)	0	0	0	0	0	0
5 ft. (1.5 m), 8 in. dia. (203) Flex Duct	5	10	18	19	21	12
End Reflection	10	5	2	1	0	0
Space Effect	5	6	7	8	9	10
Total Attenuation Deduction	24	28	39	53	59	40

Medium Box 300 – 700 cfm	Octave Band					
	2	3	4	5	6	7
Environmental Effect	2	1	0	0	0	0
5 ft. (1.5 m) 1" (25) Duct Lining	2	4	10	20	20	14
Branch Power Division (2 outlets)	3	3	3	3	3	3
5 ft. (1.5 m), 8 in. dia. (203) Flex Duct	5	10	18	19	21	12
End Reflection	10	5	2	1	0	0
Space Effect	5	6	7	8	9	10
Total Attenuation Deduction	27	29	40	51	53	39

Large Box >700 cfm	Octave Band					
	2	3	4	5	6	7
Environmental Effect	2	1	0	0	0	0
5 ft. (1.5 m) 1" (25) Duct Lining	2	3	9	18	17	12
Branch Power Division (3 outlets)	5	5	5	5	5	5
5 ft. (1.5 m), 8 in. dia. (203) Flex Duct	5	10	18	19	21	12
End Reflection	10	5	2	1	0	0
Space Effect	5	6	7	8	9	10
Total Attenuation Deduction	29	30	41	51	52	39

1. Flexible duct is non-metallic with 1" (25) insulation.
2. Space effect (room size and receiver location) 2500 ft.³ (69 m³) and 5 ft. (1.5 m) distance from source.

For a complete explanation of the attenuation factors and the procedures for calculating room NC levels, please refer to the acoustical engineering guidelines at the back of this catalog and AHRI Standard 885.

Liner and Acoustic Media Options

Nailor offers several liner choices for Single Duct Terminal Units applications. Whether the application requires industry standard fiberglass or a high IAQ (Indoor Air Quality) type, each liner provides acoustical attenuation of discharge and radiated sound as well as addresses concerns with fiberglass erosion, microbial growth and isolation of insulation from the airstream.

As the Single Duct Terminals are used in various applications, not all liner choices are available for each series. The following chart summarizes availability of liners per series:

TERMINAL UNITS	LINERS							SILENCER			
	DD Fiberglass	1" DD Fiberglass	Steri-Liner	Fiber Free (Close-Cell Foam)	Perforated Metal Liner	Perforated Metal + Steri-Liner	Solid Metal Liner	FAM (Fiberglass Acoustic Media)	FCL (Fiberglass Cloth Liner)	MSL (Mylar/Spacer Liner)	MSSL (Mylar/Spacer/Steri-Liner)
Series:											
3000	Std.	Opt.	Opt.	Opt.	Opt.	Opt.	Opt.	N/A	N/A	N/A	N/A
3000Q	Std.	N/A	Opt.	Opt.	Opt.	Opt.	Opt.	Std.	Opt.	Opt.	N/A
30HQ	N/A	N/A	Std.	N/A	N/A	N/A	N/A	N/A	N/A	N/A	Std.
30X	Std.	N/A	Opt.	Opt.	Opt.	Opt.	Opt.	N/A	N/A	N/A	N/A
30HQX	N/A	N/A	Std.	N/A	N/A	N/A	Opt.	N/A	N/A	N/A	Std.
3100	Std.	Opt.	Opt.	Opt.	Opt.	Opt.	Opt.	N/A	N/A	N/A	N/A

General Notes On Liner Types And Offerings By Series:

3000 and 3100 Series

Liner inside optional attenuator will match VAV terminal liner unless otherwise stated.

3000Q Series

There are two components to the 3000Q Series terminal units, the VAV terminal and the dissipative silencer. Liner selection determines the liner type installed into the terminal portion only. Each dissipative silencer is lined top and bottom with fiberglass as standard. When the FCL or MSL acoustic media is selected, a foil faced fiberglass is used. As the entire silencer is internally insulated, there is no need for field applied duct wrap.

There are three acoustic media options available within the side pods of the dissipative silencer. From the standard FAM (Fiberglass Acoustic Media) to IAQ sensitive options, each version provides superior attenuation characteristics.

30HQ Series

Model 30HQ Hospital Grade terminal units include, as standard, Steri-Liner in the VAV section. The top and bottom of the dissipative silencer is lined with Steri-Liner while the side pods include fiberglass acoustic media encapsulated within a Mylar bag, and then covered with perforated metal baffles. Like the 3000Q series, the 30HQ Series does not require field applied thermal duct wrap.

30X Series

Liner inside optional attenuator will match VAV terminal liner unless otherwise stated.

30HQX Series

Model 30HQX Hospital Grade exhaust units include, as standard, Steri-Liner in the VAV section, with a solid metal liner as an option. The top and bottom of the dissipative inlet silencer is lined with Steri-Liner while the sides are lined with fiberglass acoustic media encapsulated in a Mylar bag and then covered with perforated metal baffles. The 30HQX also does not require field applied thermal duct wrap.

A

SINGLE DUCT TERMINAL UNITS

Liners

Dual Density Fiberglass

Nailor uses dual density blanket-type fiber glass insulation with a high density skin, on the exposed side and a low density core. The 4 lb. high density skin aids in resisting abrasion and erosion from airflow. Furthermore, Nailor coats all exposed edges with NFPA 90A approved sealant to reduce erosion and the entrainment of fibers into the airstream.

Fiberglass liner contributes to indoor comfort by lowering heat loss or gain through duct walls. Additionally, fiberglass liner enhances indoor environmental quality by absorbing sound within duct. The thermal and acoustical absorption of fiberglass is generally classified as excellent.

- 3/4" (19) thick dual density insulation, 4 lb./cu. ft. (64 kg/m³) skin and 1.5 lb./cu. ft. (24 kg/m³) core, with exposed edges coated to reduce air erosion.
- 1" (25) thick dual density insulation optional.

Meets requirements:

- UL 181 & 723
- NFPA 90A & 90B
- ASTM E 84 & C 1071
- CAN/ULC S102

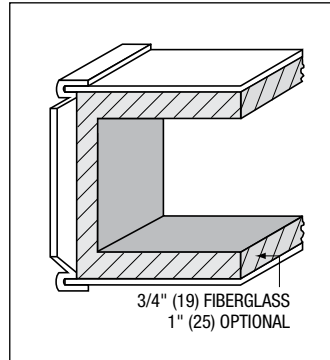

Steri-Liner

Steri-Liner is an internal insulation designed to reduce the risk of microbial growth within the terminal. A smooth non-porous facing provides a vapor barrier to moisture and reduces the risk of microorganisms becoming trapped. This facing also facilitates cleaning and prevents insulating material erosion. Damage to the liner will expose fiberglass particles to the airstream.

Acoustic absorption of aluminum foil lined insulation is reduced for discharge sound levels and essentially unchanged for radiated sound levels when compared to standard fiberglass insulation.

- 13/16" (21) thick, 4 lb./cu. ft. (64 kg/m³) density rigid fiberglass with a fire resistant reinforced aluminum FSK (foil-scrim-kraft) facing.
- 1" (25) thick steri-liner insulation optional.
- No exposed edges. Steri-Liner features notch and tuck fabrication and full seam length steel Z-strip construction providing both superior edge protection and an extremely rigid terminal.

- Metal nosing at unit discharge captures and seals insulation ends.
- End nosing is provided and sealed in place to eliminate the risk of liner damage and aid installation.

Meets requirements:

- UL 181 & 723
- NFPA 90A & 90B
- ASTM E 84, C 665, C 1071, C 1338, G21 & G22

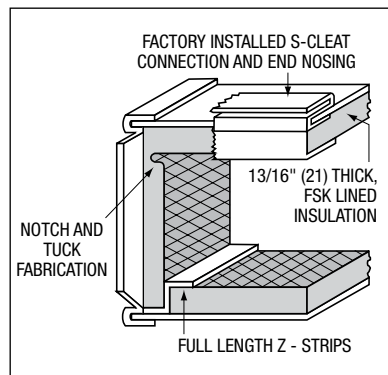

Fiber Free Liner

Nailor's Fiber-Free liner is a closed cell elastomeric foam. This liner has excellent insulating characteristics and provides acoustical attenuation roughly equivalent to Steri-Liner. The construction of fiber free insulation prevents the insulation from absorbing water, helping to reduce the likelihood of mold or bacterial growth.

- 3/4" (19) thick closed cell elastomeric foam.
- Smooth washable surface helps to prevent dirt and debris from accumulating.

Meets requirements:

- UL 181 & 723
- ASTM E 84, C 209 & C 665
- CAN/ULC S102

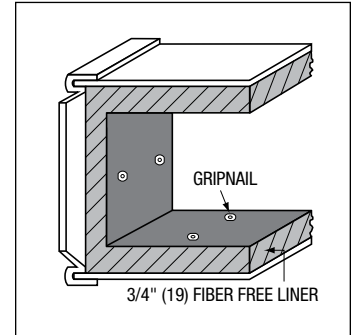

Perforated Metal Liner

Standard dual density fiberglass insulation covered with a 50% free area perforated metal sheet, constructed of steel, as a duct liner. The perforated metal sheet provides additional protection against erosion by airflow, but does not prevent moisture from contacting the insulation. Small fiberglass particles may escape through the metal perforations should the skin of the insulation be compromised.

- 22 ga. (.86) perforated steel liner.
- 3/4" (19) dual density fiberglass insulation, 4 lb./cu. ft. (64 kg/m³) skin.

Meets requirements:

- UL 181 & 723
- ASTM E 84, C 665 & C 1071

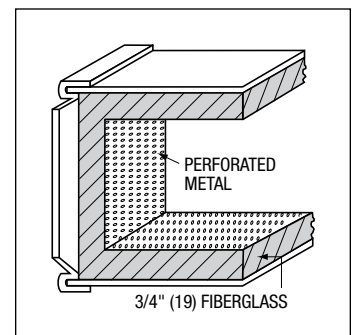

Steri-Liner + Perforated Metal Liner

This liner includes a 50% free area perforated metal sheet that covers the Steri-Liner insulation. By covering the Steri-Liner, the perforated metal helps to protect the FSK (foil-scrim-kraft) facing from punctures.

- 22 ga. (.86) perforated steel liner.
- 13/16" (21) thick, 4 lb./cu. ft. (64 kg/m³) density rigid fiberglass with FSK facing.
- Metal nosing at unit discharge captures and seals insulation ends.
- Z-strip construction providing both superior edge protection and an extremely rigid terminal.

Meets requirements:

- UL 181, 723
- ASTM E 84, C 665 & C 1071

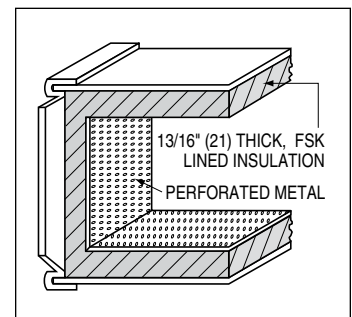

Solid Metal Liner

Nailor offers a solid inner metal liner that completely isolates the standard fiberglass liner from the airstream. Solid metal liners offer the ultimate protection against exposure of fiberglass particles to the airstream, all but eliminating the possibility of punctures that expose fiberglass. This option is also resistant to moisture. The encased insulation still provides thermal resistance and radiated sound attenuation, but acoustic absorption of discharge sound is eliminated. Solid Metal fabrication is a box within a box and uses metal end nosing to encapsulate exposed edges of the insulation.

- Solid inner liner is 22 ga. (.86) steel.
- 3/4" (19) dual density fiberglass insulation, 4 lb./ cu. ft. (64 kg/m³) skin and 1.5 lb./cu. ft. (24 kg/m³) core.

Meets requirements:

- UL 181 & 723
- ASTM E 84, C 655 & C 1071
- NFPA 90A & 90B

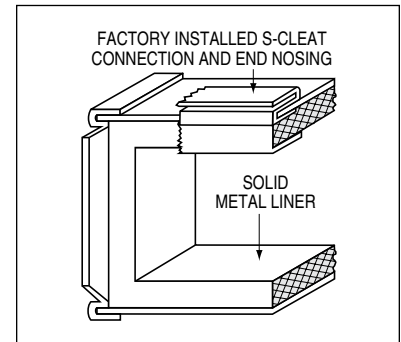

Dissipative Silencer

Acoustic Media

A Dissipative Silencer is standard on all 3000Q, 30HQ and 30HQX Series terminal units. There are three acoustic media options available on the 3000Q Series silencers; FAM, FCL and MSL. All 30HQ and 30HQX Hospital Grade units include a MSSL acoustic media option as standard. From the standard fiberglass media to the IAQ sensitive options, each version provides superior attenuation characteristics.

Fiberglass Acoustic Media (FAM)

The Standard FAM choice is the simplest of the types offered and provides the best attenuation of discharge sound. Fiberglass insulation is packed between the silencer casing and the side pod metal silencer baffles. There is minimal exposure of the fiberglass through the perforations of the metal side baffles.

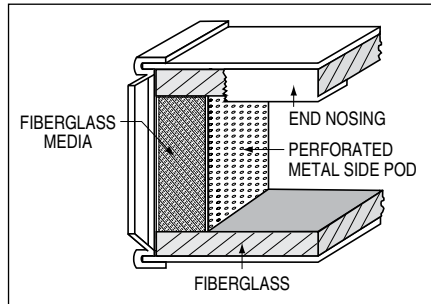

Meets requirements:

- UL 181
- NFPA 90A & 90B
- ASTM E 84, C 1071 & C 655

Fiberglass Cloth (FCL)

A tightly woven fiberglass cloth encapsulates the fiberglass media packed between the silencer casing and the side pod silencer baffles. The cloth eliminates the erosion of the fiberglass media and prevents entrainment of fibers into the airstream. Since the cloth is porous, it absorbs sound. Performance of the cloth liner is similar to the fiberglass lined silencer and offers the best balance between fiberglass erosion and sound attenuation.

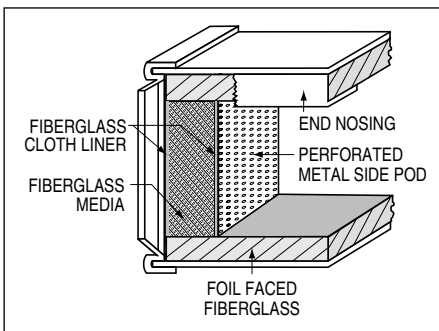

Meets requirements:

- UL 181 & 723
- ASTM E 84, C 655 & C 1071
- NFPA 90A

Mylar/Spacer (MSL)

Similar to the fiberglass cloth liner, the fiberglass media is wrapped. Using Mylar to create an impregnable barrier around the acoustic media, this option is recommended where isolating fiberglass material is a critical concern. This option is an excellent choice for IAQ sensitive applications.

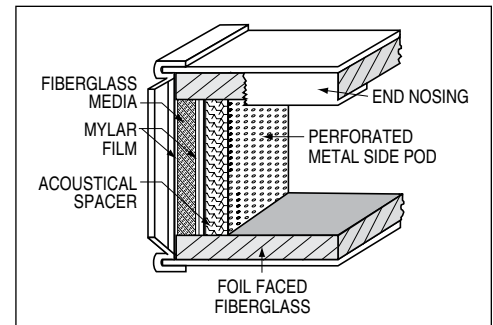

Meets requirements:

- NFPA 90A & 90B
- UL 181 & 723
- UL 94 (mylar)
- ASTM E 84, C 665, C 1338 & C 1071

Mylar/Spacer Steri-Liner (MSSL)

Standard on all hospital grade series, this acoustic media version is similar to the MSL option but substitutes Steri-Liner in place of the foil faced fiberglass. Using Mylar to create an impregnable barrier around the fiberglass acoustic media. This option is an excellent choice for IAQ sensitive applications.

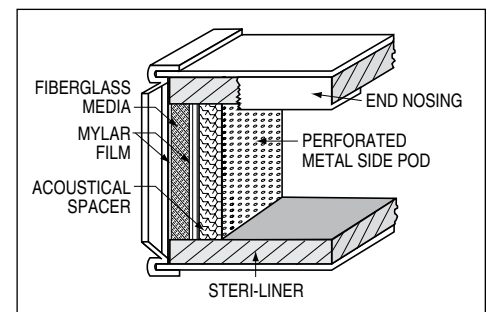

Meets requirements:

- NFPA 90A & 90B
- UL 181, 723
- UL 94 (mylar)
- ASTM E 84, C 665, C 1338 & C 1071

DUAL DUCT TERMINAL UNITS



TABLE OF CONTENTS

B

DUAL DUCT TERMINAL UNITS

	Page No.
Product Overview	
3200 Series	B3
Introduction and Features	B4
Model 3210 • Without Attenuator	
Dimensional Data	
Model 3210 • Without Attenuator • Non-Mixing Applications	B5
Recommended Airflow Ranges for Model 3210	B6
Performance Data	
Model 3210 • NC Level Application Guide	B7
• Discharge Sound Power Levels	B8
• Radiated Sound Power Levels	B9
• AHRI Certification and Performance Notes	B10
Introduction and Features	B11
Model 3230 • With Compact Mixing Attenuator	
Dimensional Data	
Model 3230 • Compact Mixing Attenuator • Mixing Application	B12
Recommended Airflow Ranges for Model 3230	B13
Performance Data	
Model 3230 • NC Level Application Guide	B14
• Discharge Sound Power Levels	B15
• Radiated Sound Power Levels	B16
• AHRI Certification and Performance Notes	B17
Introduction and Features	B18
Model 3240 • With High Efficiency Mixing Attenuator	
Dimensional Data	
Model 3240 • "BlendMaster™" • Mixing Applications	B19
Recommended Airflow Ranges for Model 3240	B20
Performance Data	
Model 3240 • NC Level Application Guide	B21
• Discharge Sound Power Levels	B22
• Radiated Sound Power Levels	B23
• AHRI Certification and Performance Notes	B24
Performance Data Explanation	B25
Options	
Liner	B26
Access Door	B27
Diamond Flow Sensor Locations	B28

PRODUCT OVERVIEW

MODELS: 3210, 3230 AND 3240

Nailor dual duct terminals are designed to precisely regulate and vary the volume of both the cold and hot deck of a dual duct distribution system in response to thermostat demand. The resulting volume regulation lends itself to precise temperature control for a conditioned zone.

Applications where precision zone pressure control is critical, such as hospitals, research facilities or institutions, benefit from the pressure independent control setup of the individual decks. Each deck working in conjunction with available mixing attenuators delivers a total flow that works as constant or variable volume.

Nailor offers three models of dual duct terminal units to meet a variety of applications. Model 3210 is used when no terminal mixing is required. The 3210 is two single duct terminals working in tandem to regulate the cold and hot airstreams. When terminal blending of cold and hot decks is required, both the model 3230 and 3240 are excellent choices. Model 3230 terminals include an integral compact attenuator section which provides both attenuation of discharge noise and mixing of airstreams by use of internal baffles. Minimum mixing efficiency for the 3230 is 1:12. Model 3240 "Blendmaster™" provides many of the same features of the 3230, but increases the minimum mixing efficiency to 1:30. The 3240 provides the best balance of mixing efficiency, quiet operation and minimum operating pressures of any dual duct terminal.

Each Nailor Dual Duct terminal casing is constructed of 22 ga. (0.86) zinc coated steel constructed to provide low leakage. Internally, the unit contains low leakage opposed blade dampers, multi-point averaging Diamond Flow Sensors and standard dual density fiberglass insulation. Several IAQ Liner options are available. Control options include digital, analog electronic and pneumatic for pressure independent applications.



3210 Without Attenuator



3230 With Compact Mixing Attenuator



3240 "Blendmaster™" With High Efficiency Mixing Attenuator

DUAL DUCT VARIABLE OR CONSTANT AIR VOLUME

3200 SERIES
• 1:12 MIXING

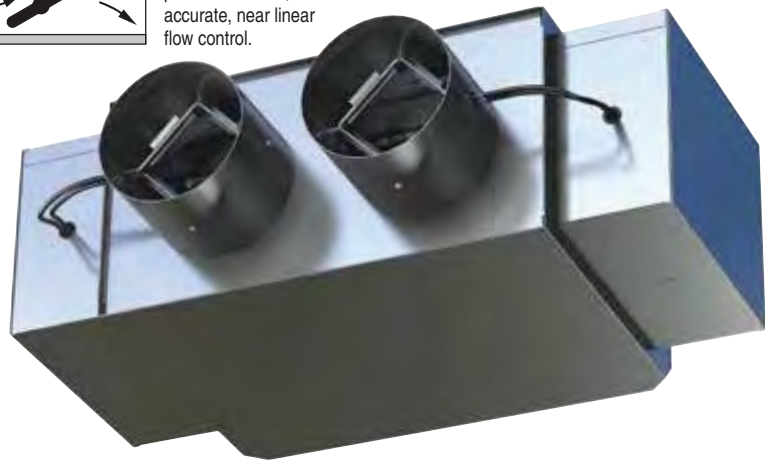
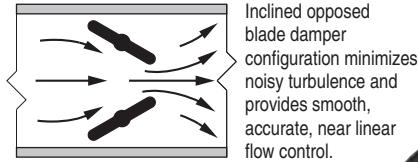

Model 3210

Model:
3210 Without Attenuator

Nailor model 3210 is an economical dual duct terminal ideal for non-mixing variable volume applications. Constructed as two single ducts, the 3210 consists of a dedicated hot and cold deck. The decks work in tandem to regulate the cold and hot airstreams to provide precise volume and temperature control for the conditioned zone. Each inlet contains a standard Diamond Flow Sensor for pressure independent operation.

STANDARD FEATURES:

- 22 ga. (0.86) zinc coated steel casing, mechanically sealed, low leakage construction.
- 16 ga. (1.63) corrosion-resistant steel inclined opposed blade dampers with extruded PVC seals (single blade on size 4, 5, 6). 45° rotation, CW to close. Tight shut-off. Damper leakage is less than 2% of the terminal rated airflow at 3" w.g. (750 Pa).
- 1/2" (13) dia. plated steel driveshaft. An indicator mark on the end of the shaft shows damper position.
- Multi-point averaging Diamond Flow Sensors in each inlet. Aluminum construction. Supplied with balancing tees.

- Rectangular discharge with slip and drive cleat duct connection.
- Full NEMA1 type enclosure for factory mounted controls.
- 3/4" (19), dual density insulation, exposed edges coated to prevent air erosion. Meets the requirements of NFPA 90A and UL 181.
- Choice of right or left-hand cold deck location. Hand of unit is determined by location of cold deck looking in direction of airflow. Unit is flippable. Right-hand unit illustrated.
- Unequal inlet sizes are an available option.

Controls:

- Digital (supplied by others).
- Analog (by Nailor).

Options and Accessories:

- 24 VAC Control transformer.
- Toggle disconnect switch.
- Steri-liner.
- Fiber-free liner.
- Perforated metal liner.
- Solid metal liner.
- 1" (25) liner.
- Controls enclosure for field or factory mounted controls.
- Dust tight enclosure seal.
- Hanger brackets.
- Seismic Certification.



Intertek



Dimensions

Model 3210 • Without Attenuator • Non-Mixing Applications

- Variable volume cold and variable volume hot deck control. Zero minimum. No mixing.
- Multi-point flow sensors in each inlet provide accurate flow control.
- Opposed blade dampers control each deck independently. 45° rotation. CW to close.
- Right hand and left hand are flippable.
- Rectangular discharge with slip and drive connection.
- Choice of right or left hand cold deck location. Hand of unit is determined by location of cold deck looking in direction of airflow. Right hand unit illustrated.

Pneumatic Controls

- Universal pneumatic control mounting panel features double wall stand-off construction for strength and rigidity. Controls mounting screws do not penetrate casing.

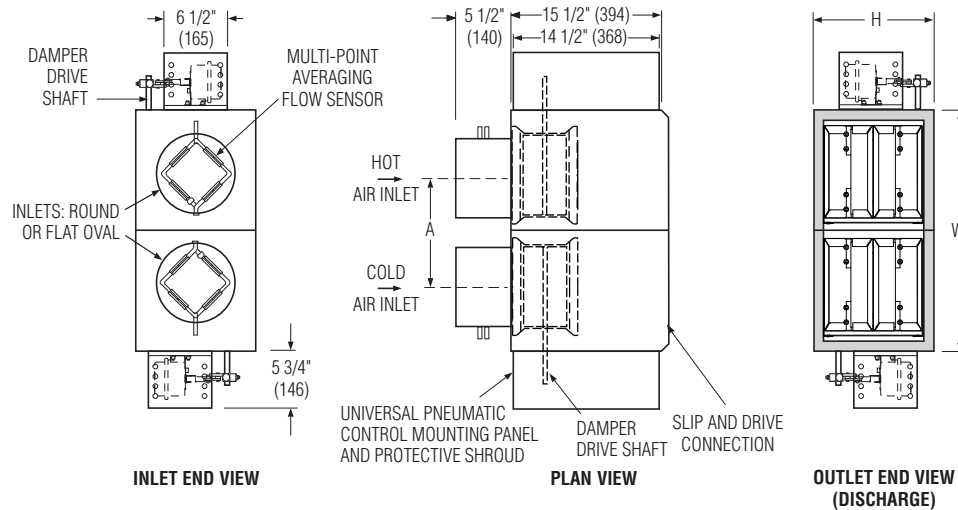

Analog Electronic and Digital Controls

- A full NEMA 1 controls enclosure is provided for factory mounted controls. Optional for field mounted controls.

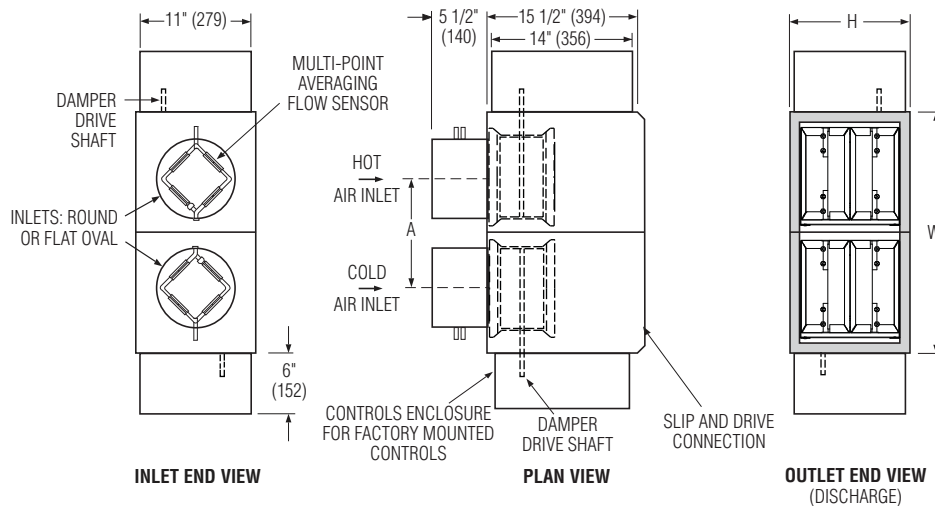

Dimensional Data

Unit Size	W	H	A	Inlet Size
4	21 (533)	10 (254)	11 (279)	3 7/8 (98) Round
5	21 (533)	10 (254)	11 (279)	4 7/8 (124) Round
6	21 (533)	10 (254)	11 (279)	5 7/8 (149) Round
7	25 (635)	12 1/2 (318)	13 (330)	6 7/8 (175) Round
8	25 (635)	12 1/2 (318)	13 (330)	7 7/8 (200) Round
9	29 (737)	12 1/2 (318)	15 (381)	8 7/8 (225) Round
10	29 (737)	12 1/2 (318)	15 (381)	9 7/8 (251) Round
12	37 (940)	12 1/2 (318)	19 (483)	12 15/16 x 9 13/16 (329 x 249) Oval
14	49 (1245)	12 1/2 (318)	25 (635)	16 1/16 x 9 13/16 (408 x 249) Oval
16	57 (1448)	12 1/2 (318)	29 (737)	19 3/16 x 9 13/16 (487 x 249) Oval

Recommended Airflow Ranges For Model 3210 Dual Duct Pressure Independent Terminal Units

The recommended airflow ranges below are for dual duct terminal units with pressure independent controls and are presented as ranges for total and controller specific minimum and maximum airflow. Airflow ranges are based upon maintaining reasonable sound levels and controller limits using Nailor's Diamond Flow Sensor as the airflow measuring device. For a given unit size, the minimum, auxiliary minimum (where applicable) and the maximum flow setting must be within the range limits to ensure pressure independent operation, accuracy and repeatability.

Minimum airflow limits are based upon .02" w.g. (5 Pa) differential pressure signal from Diamond Flow Sensor on analog/ digital controls and .03" (7.5) for pneumatic controllers. This is a realistic low limit for many transducers used in the digital controls industry. Check your controls supplier for minimum limits. Setting airflow minimums lower, may cause damper hunting and result in a failure to meet minimum ventilation requirements. Where an auxiliary setting is specified, the value must be greater than the minimum setting.

The high end of the tabulated Total Airflow Range on pneumatic and analog electronic controls represents the Diamond Flow Sensor's differential pressure reading at 1" w.g. (250 Pa). The high end airflow range for digital controls is represented by the indicated transducer differential pressure.

ASHRAE 130 "Performance Rating of Air Terminals" is the method of test for the certification program. The "standard rating condition"



Model 3210

(certification rating point) airflow volumes for each terminal unit size are tabulated below per AHRI Standard 880. These air volumes equate to an approximate inlet velocity of 2000 fpm (10.2 m/s).

When digital or other controls are mounted by Nailor, but supplied by others, these values are guidelines only, based upon experience with the majority of controls currently available. Controls supplied by others for factory mounting are configured and calibrated in the field. Airflow settings on pneumatic and analog controls supplied by Nailor are factory preset when provided.

Imperial Units, Cubic Feet per Minute

Unit Size	Inlet Type	Total Airflow Range, cfm	Airflow at 2000 fpm Inlet Velocity (nom.), cfm	Range of Minimum and Maximum Settings, cfm							
				Pneumatic 3000 Controller		Analog Electronic Controls		Digital Controls			
				Transducer Differential Pressure ("w.g.)							
				Min.	Max.	Min.	Max.	Min.	Max.		
									1.0	1.25	1.5
4	Round	0 – 225	150	30	180	25	180	25	180	200	225
5		0 – 400	250	55	325	45	325	45	325	360	400
6		0 – 550	400	80	450	65	450	65	450	500	550
7	Round	0 – 800	550	115	650	95	650	95	650	725	800
8		0 – 1100	700	155	900	125	900	125	900	1000	1100
9		0 – 1400	900	200	1150	165	1150	165	1150	1285	1400
10		0 – 1840	1100	260	1500	215	1500	215	1500	1675	1840
12	Flat Oval	0 – 2500	1600	355	2050	290	2050	290	2050	2300	2500
14		0 – 3125	2100	440	2550	360	2550	360	2550	2850	3125
16		0 – 3725	2800	525	3040	430	3040	430	3040	3400	3725

Metric Units, Liters per Second

Unit Size	Inlet Type	Total Airflow Range, l/s	Airflow at 10.2 m/s Inlet Velocity (nom.), l/s	Range of Minimum and Maximum Settings, l/s								
				Pneumatic 3000 Controller		Analog Electronic Controls		Digital Controls				
				Transducer Differential Pressure (Pa)								
				Min.	Max.	Min.	Max.	Min.	Max.			
									5	249	311	374
4	Round	0 – 106	71	14	85	12	85	12	85	94	106	
5		0 – 189	118	26	153	21	153	21	153	170	189	
6		0 – 260	189	38	212	31	212	31	212	236	260	
7	Round	0 – 378	260	54	307	45	307	45	307	342	378	
8		0 – 519	330	73	425	59	425	59	425	472	519	
9		0 – 661	425	94	543	78	543	78	543	606	661	
10		0 – 868	519	123	708	101	708	101	708	790	868	
12	Flat Oval	0 – 1180	755	168	967	137	967	137	967	1085	1180	
14		0 – 1475	991	208	1203	170	1203	170	1203	1345	1475	
16		0 – 1758	1321	248	1435	203	1435	203	1435	1604	1758	

Performance Data • NC Level Application Guide

Model 3210 • Without Attenuator • Non-Mixing Applications

Fiberglass Liner

Inlet Size	Airflow cfm /s		Min. inlet ΔPs "w.g. Pa		NC Levels @ Inlet Pressure (ΔPs) shown											
					DISCHARGE					RADIATED						
					Min. ΔPs	0.5" w.g. (125 Pa)	1.0" w.g. (250 Pa)	1.5" w.g. (375 Pa)	2.0" w.g. (500 Pa)	3.0" w.g. (750 Pa)	Min. ΔPs	0.5" w.g. (125 Pa)	1.0" w.g. (250 Pa)	1.5" w.g. (375 Pa)	2.0" w.g. (500 Pa)	3.0" w.g. (750 Pa)
4	225	106	0.53	133	21	*	30	33	34	36	-	*	-	23	25	29
	200	94	0.43	106	20	25	29	33	34	35	-	-	-	21	24	28
	150	71	0.24	61	-	21	26	29	30	30	-	-	-	21	22	22
	100	47	0.11	28	-	-	21	21	21	21	-	-	-	-	20	23
	75	35	0.06	16	-	-	-	-	-	-	-	-	-	-	-	20
5	400	189	0.19	48	-	25	30	33	35	37	-	-	-	23	26	31
	300	142	0.11	28	-	25	31	33	35	37	-	-	-	21	23	28
	250	118	0.08	20	-	25	30	34	35	36	-	-	-	19	22	25
	200	94	0.05	13	-	23	26	30	31	33	-	-	-	-	20	22
	125	59	0.02	5	-	-	20	21	21	21	-	-	-	-	-	-
6	550	260	0.08	19	-	26	33	36	38	41	-	-	20	25	28	31
	450	212	0.06	14	-	28	33	36	39	41	-	-	19	22	24	29
	400	189	0.05	12	-	28	33	36	39	41	-	-	18	21	25	29
	200	94	0.02	4	-	23	28	30	31	30	-	-	-	-	-	20
	100	47	0.01	2	-	-	-	-	-	-	-	-	-	-	-	-
7	800	378	0.17	44	25	29	33	36	39	44	25	-	22	28	33	37
	650	307	0.12	29	23	25	31	35	38	43	20	-	21	24	29	34
	550	260	0.08	21	-	23	30	34	37	39	-	-	19	24	28	32
	335	158	0.03	8	-	-	25	28	29	30	-	-	-	20	22	24
	225	106	0.01	2	-	-	21	23	23	23	-	-	-	-	-	-
8	1100	519	0.03	6	24	29	33	36	38	44	-	20	25	29	31	35
	900	425	0.02	5	20	26	30	34	37	41	-	-	23	26	29	33
	700	330	0.01	2	-	25	30	35	38	41	-	-	21	24	26	31
	600	283	0.01	2	-	21	29	34	36	39	-	-	-	23	25	31
	400	189	0.01	2	-	-	25	29	31	34	-	-	-	20	21	25
9	1400	661	0.01	2	21	29	33	35	38	41	20	20	23	28	34	38
	1250	590	0.01	2	-	28	31	35	37	41	-	20	22	26	33	36
	900	425	0.01	2	-	23	28	33	36	40	-	-	-	23	28	31
	675	319	0.01	2	-	-	28	33	35	37	-	-	-	20	25	26
	450	212	0.01	2	-	-	24	28	29	30	-	-	-	-	20	22
10	1850	873	0.01	2	23	35	37	39	40	43	22	22	26	31	33	37
	1650	779	0.01	2	20	33	35	37	39	43	-	20	25	30	31	36
	1100	519	0.01	2	-	25	28	31	35	38	-	-	21	24	25	31
	825	389	0.01	2	-	-	25	29	33	36	-	-	-	21	23	28
	550	260	0.01	2	-	-	23	26	29	31	-	-	-	-	-	22
12	2500	1180	0.01	2	22	38	39	40	41	44	29	28	31	34	35	40
	2000	944	0.01	2	-	34	34	37	38	41	22	25	29	31	33	37
	1600	755	0.01	2	-	29	31	34	36	39	-	20	25	28	30	35
	1200	566	0.01	2	-	21	25	29	33	36	-	-	20	24	28	31
	800	378	0.01	2	-	-	20	24	26	29	-	-	-	20	21	24
14	3125	1475	0.01	2	23	36	39	41	43	45	29	28	31	36	39	43
	2700	1274	0.01	2	20	33	36	38	40	43	24	25	30	34	37	40
	2100	991	0.01	2	-	29	31	34	36	39	-	21	26	31	34	37
	1550	731	0.01	2	-	20	26	30	34	37	-	-	24	28	30	34
	1050	495	0.01	2	-	-	24	26	29	31	-	-	-	24	26	28
16	3725	1758	0.08	20	26	35	40	41	43	45	30	30	33	37	40	44
	3500	1652	0.07	18	24	34	38	40	41	44	28	30	33	36	39	43
	2800	1321	0.05	12	20	31	35	36	38	40	23	24	29	34	36	40
	2100	991	0.05	12	-	23	28	30	33	36	-	-	26	30	34	36
	1400	661	0.01	2	-	-	21	25	28	30	-	-	21	26	29	31

Performance Notes:

1. NC Levels are calculated based on procedures as outlined on page B25.
2. Dash (-) in space indicates a NC less than 20.
3. Asterisk (*) in space indicates that the minimum inlet static pressure requirement is greater than 0.5" w.g. (125 Pa) at rated airflow.

Performance Data • Discharge Sound Power Levels
 Model 3210 • Without Attenuator • Non-Mixing Applications
 Fiberglass Liner



B
DUAL DUCT TERMINAL UNITS

Inlet Size	Airflow		Min. inlet ΔPs		Sound Power Octave Bands @ Inlet Pressure (ΔPs) shown																																									
					Minimum ΔPs							0.5" w.g. (125Pa) ΔPs							1.0" w.g. (250Pa) ΔPs							1.5" w.g. (375Pa) ΔPs							2.0" w.g. (500Pa) ΔPs							3.0" w.g. (750Pa) ΔPs						
					2	3	4	5	6	7	2	3	4	5	6	7	2	3	4	5	6	7	2	3	4	5	6	7	2	3	4	5	6	7	2	3	4	5	6	7						
4	225	106	0.53	133	65	60	58	60	52	47	*	*	*	*	*	*	70	69	65	61	52	49	72	71	67	62	54	51	73	72	68	64	57	54	74	74	70	66	60	57						
	200	94	0.43	106	64	58	56	58	49	46	67	65	63	61	50	46	69	68	64	60	51	48	72	71	66	62	54	51	73	72	67	63	56	54	73	73	70	67	59	57						
	150	71	0.24	61	61	53	50	50	40	37	65	62	55	51	42	39	68	66	60	56	48	45	69	68	62	58	51	48	68	69	65	60	53	50	69	69	68	67	58	54						
	100	47	0.11	28	57	43	33	29	-	-	63	56	50	46	37	32	64	62	57	52	45	41	64	62	61	57	49	44	64	62	62	63	53	48	64	62	63	66	58	54						
	75	35	0.06	16	59	44	34	29	-	-	61	54	48	44	35	29	63	58	57	53	44	38	61	58	59	59	50	44	60	58	60	62	53	48	60	56	60	61	56	53						
5	400	189	0.19	48	62	59	56	61	53	48	67	66	65	64	54	49	71	70	70	67	56	51	73	72	72	69	58	53	75	74	73	70	59	55	76	76	75	71	62	58						
	300	142	0.11	28	61	56	51	55	46	41	67	66	62	60	49	44	70	71	65	63	52	48	73	72	67	64	54	51	74	74	69	66	56	53	75	76	71	68	59	57						
	250	118	0.08	20	59	52	47	49	40	34	65	65	57	55	44	40	69	69	61	58	48	45	71	72	63	61	51	48	72	73	65	63	54	51	73	74	68	66	58	55						
	200	94	0.05	13	58	48	42	42	32	26	65	63	53	50	40	36	68	66	57	55	45	42	69	69	60	58	49	46	70	70	63	60	52	50	71	71	66	65	56	54						
	125	59	0.02	5	57	44	31	27	-	-	63	54	47	44	34	30	64	60	54	50	41	38	65	62	59	55	46	42	65	62	61	62	50	46	64	62	63	67	59	53						
6	550	260	0.08	19	61	60	54	60	50	45	68	67	62	64	52	47	73	72	67	66	54	50	75	75	69	68	56	53	77	77	72	71	59	55	78	80	75	73	62	59						
	450	212	0.06	14	60	56	50	55	45	38	68	68	59	60	48	43	73	72	64	63	51	48	75	75	68	66	54	51	76	78	70	69	57	53	78	80	73	71	60	57						
	400	189	0.05	12	59	53	47	52	41	35	67	68	58	58	46	41	72	72	63	62	50	47	74	75	66	64	53	50	75	78	69	67	56	52	78	80	72	69	60	56						
	200	94	0.02	4	55	42	32	31	20	-	66	58	49	48	36	31	70	62	55	53	43	38	72	66	59	56	47	43	73	67	61	58	50	46	72	69	65	64	54	50						
	100	47	0.01	2	56	39	-	-	-	-	59	50	43	39	28	24	60	56	52	46	37	33	61	58	57	55	44	39	61	59	58	60	49	44	60	59	60	64	56	52						
7	800	378	0.17	44	69	67	69	66	56	51	72	70	65	61	54	50	76	73	68	65	57	54	81	76	72	69	61	58	83	79	74	71	64	60	85	83	78	74	68	65						
	650	307	0.12	29	66	64	63	60	51	46	70	66	60	57	51	48	74	71	66	63	56	53	78	74	70	67	60	57	80	77	72	69	63	60	82	81	76	72	67	64						
	550	260	0.08	21	65	61	58	55	46	39	69	63	58	55	49	44	75	69	65	61	55	50	78	73	68	65	59	55	79	76	70	67	61	57	80	78	74	69	65	61						
	335	158	0.03	8	57	49	43	40	30	22	65	58	54	51	44	38	71	65	59	57	51	46	72	68	63	59	54	50	73	69	66	61	56	52	73	70	69	65	59	55						
	225	106	0.01	2	55	41	32	28	-	-	63	55	50	47	40	35	65	61	56	52	46	41	66	63	61	56	50	45	66	63	63	59	53	48	66	63	64	62	56	53						
8	1100	519	0.03	6	68	66	70	68	59	52	73	70	72	70	59	52	78	73	72	69	59	53	81	76	74	71	62	55	83	78	76	73	64	58	86	83	79	76	68	63						
	900	425	0.02	5	66	63	64	61	52	46	71	68	66	63	53	47	77	71	68	65	56	51	79	74	71	68	59	55	82	77	73	70	62	58	85	81	76	73	66	62						
	700	330	0.01	2	63	60	57	55	46	40	70	66	61	58	50	45	75	70	65	62	54	51	79	73	68	65	58	54	81	76	71	68	61	58	83	80	75	71	64	61						
	600	283	0.01	2	60	56	53	51	41	34	68	63	58	55	47	43	74	68	63	60	53	49	78	73	67	63	56	53	80	75	69	66	59	56	81	78	73	69	63	60						
	400	189	0.01	2	56	47	42	38	27	20	65	59	53	50	42	38	71	66	59	55	49	45	74	69	63	59	53	49	74	71	66	61	55	52	75	73	69	65	59	56						
9	1400	661	0.01	2	66	63	68	66	59	53	74	70	71	69	60	54	77	73	72	70	62	56	80	75	74	71	64	59	82	78	76	73	66	61	85	81	79	76	69	65						
	1250	590	0.01	2	65	61	64	62	55	49	72	69	68	66	57	51	76	72	70	67	60	54	79	75	72	69	62	57	81	77	74	71	64	59	85	81	77	75	68	63						
	900	425	0.01	2	62	55	54	53	45	39	69	65	60	58	53	49	74	69	64	62	55	53	78	73	68	65	59	56	80	76	70	68	61	58	82	80	74	71	66	63						
	675	319	0.01	2	58	48	46	44	36	28	66	60	55	53	48	43	73	67	62	59	53	49	76	72	65	63	57	54	78	74	68	65	60	56	78	76	72	68	63	60						
	450	212	0.01	2	55	41	36	32	23	20	64	57	52	48	42	38	70	64	58	55	49	45	71	68	62	58	53	49	71	69	65	60	56	52	71	70	68	65	59	57						
10	1850	873	0.01	2	68	65	69	67	60	54	78	75	73	72	64	57	80	77	75	74	65	58	82	79	77	76	67	61	84	80	78	77	69	63	86	82	80	79	72	67						
	1650	779	0.01	2	66	63	66	64	57	51	76	73	71	70	61	54	78	75	73	71	63	57	81	77	75	73	65	59	83	79	77	75	67	62	85	82	78	77	70	66						
	1100	519	0.01	2	67	59	54	52	44	38	72	67	62	60	54	49	75	69	66	64	57	54	77	72	68	66	59	56	79	75	70	69	62	58	82	78	74	71	66	62						
	825	389	0.01	2	59	51	46	43	35	26	67	62	57	55	49	44	72	67	62	60	53	49	75	70	65	63	56	53	76	73	67	65	59	55	78	76	71	68	63	59						
	550	260	0.01	2	55	42	35	31	21	-	63	57	52	49	42	37	69	64	58	55	49	44	71	67	61	58	52	48	71	69	64	60	55	51	73	71	67	64	59	56						
12	2500	1180	0.01	2	69	64	69	67	61	55	83	75	73	72	64	58	84	78	75	74	65	60	84	80	78	76	68	62	86	81	79	78	70	64	87	83	81	80	74	68						
	2000	944	0.01	2	68	61	62	61	54	48	80	72	68	67	59	54	80	74	72	70	62	58	81	77	74	72	65	60	83	78	76	75	67	63	85	81	78	78	72	67						
	1600	755	0.01	2	65	57	55	55	48	41	76	69	64	63	56	51	77	72	68	66	59	58	79	74	71	70	63	59	81	76	72	72	66	61	82	79	75	75	69	65						
	1200	566	0.01	2																																										

Performance Data • Radiated Sound Power Levels

Model 3210 • Without Attenuator • Non-Mixing Applications

Fiberglass Liner



Inlet Size	Airflow		Min. inlet ΔPs		Sound Power Octave Bands @ Inlet Pressure (ΔPs) shown																																									
					Minimum ΔPs							0.5" w.g. (125Pa) ΔPs							1.0" w.g. (250Pa) ΔPs							1.5" w.g. (375Pa) ΔPs							2.0" w.g. (500Pa) ΔPs							3.0" w.g. (750Pa) ΔPs						
					2	3	4	5	6	7	2	3	4	5	6	7	2	3	4	5	6	7	2	3	4	5	6	7	2	3	4	5	6	7	2	3	4	5	6	7						
4	225	106	0.53	133	-	37	33	33	-	-	*	*	*	*	*	*	51	48	45	38	32	30	55	54	49	42	33	32	55	55	51	44	35	33	56	57	54	48	39	38						
	200	94	0.43	106	-	36	33	32	-	-	-	39	37	38	29	29	49	46	43	37	30	29	53	52	47	40	32	31	53	53	50	42	33	33	54	55	53	47	37	37						
	150	71	0.24	61	-	35	29	31	-	-	-	40	36	30	25	23	47	46	40	34	28	26	49	50	47	39	31	30	47	48	48	43	34	32	48	48	48	50	40	37						
	100	47	0.11	28	-	-	-	-	-	-	-	37	32	27	-	-	-	43	42	34	27	23	-	44	45	41	32	29	-	43	46	46	36	32	-	42	44	51	43	38						
	75	35	0.06	16	-	-	-	-	-	-	-	37	31	26	-	-	-	41	43	37	29	24	-	42	45	42	32	29	-	38	42	45	40	33	-	36	41	48	44	40						
5	400	189	0.19	48	49	41	34	36	34	27	52	45	40	40	39	36	56	48	45	38	37	34	60	52	49	40	39	34	63	56	51	42	40	36	63	59	56	45	44	40						
	300	142	0.11	28	47	38	32	32	30	27	50	43	37	35	33	31	54	46	44	37	35	31	57	49	47	39	38	33	59	52	49	40	39	35	59	55	53	43	43	39						
	250	118	0.08	20	-	35	31	25	23	-	50	40	36	32	30	25	54	45	42	33	32	28	55	48	45	35	35	30	56	51	48	37	37	32	57	53	51	42	41	35						
	200	94	0.05	13	-	-	-	-	-	-	50	38	34	27	25	-	52	43	39	31	30	25	52	45	43	32	32	28	53	48	46	36	36	30	53	48	44	41	41	34						
	125	59	0.02	5	-	-	-	-	-	-	-	33	29	21	-	-	48	40	38	28	27	-	48	42	42	34	33	27	49	42	44	39	38	29	49	42	44	47	46	37						
6	550	260	0.08	19	48	47	41	39	31	29	49	48	42	41	35	31	57	52	46	41	35	32	62	55	49	45	36	34	64	58	51	45	40	38	67	61	56	48	44	43						
	450	212	0.06	14	48	44	37	35	30	28	48	47	40	38	32	29	56	50	45	40	34	31	59	53	48	44	36	33	61	55	50	43	39	37	64	58	54	46	42	41						
	400	189	0.05	12	-	42	33	33	28	26	49	46	39	35	30	28	56	49	44	38	32	29	59	52	47	40	36	33	62	54	49	42	39	36	64	58	54	45	42	41						
	200	94	0.02	4	-	-	-	-	-	-	47	36	30	24	-	-	53	43	38	30	29	28	53	45	43	32	31	30	53	47	44	36	32	32	55	49	46	43	37	37						
	100	47	0.01	2	-	-	-	-	-	-	-	34	27	-	-	-	-	35	38	33	29	24	45	39	40	37	31	28	47	39	40	42	37	32	46	40	40	46	44	38						
7	800	378	0.17	44	50	47	51	37	36	36	50	48	45	37	33	33	57	52	48	40	34	32	63	58	53	46	38	35	68	62	56	49	40	38	70	66	61	54	45	42						
	650	307	0.12	29	49	45	46	38	31	30	49	48	45	37	31	29	54	50	47	40	34	32	60	54	50	44	37	35	64	58	54	48	38	36	67	63	58	51	44	43						
	550	260	0.08	21	48	43	41	33	27	25	48	44	40	32	28	26	55	49	45	38	32	30	61	54	49	43	36	33	64	58	52	45	38	36	65	61	57	50	42	40						
	335	158	0.03	8	-	-	28	33	-	-	-	40	35	29	24	-	52	48	42	36	30	28	57	51	46	40	32	30	57	52	48	42	34	32	57	53	50	47	39	38						
	225	106	0.01	2	-	-	-	-	-	-	-	39	33	28	-	-	50	45	40	34	28	25	52	47	43	38	31	29	51	47	43	41	33	31	52	48	45	42	35	36						
8	1100	519	0.03	6	52	50	45	37	34	33	57	51	46	37	35	32	60	54	51	40	38	33	65	57	53	43	42	36	67	60	56	45	44	39	70	63	60	49	48	42						
	900	425	0.02	5	51	47	40	34	31	29	56	50	45	37	34	31	58	53	49	39	37	33	63	56	51	42	42	36	65	58	54	44	44	39	68	60	56	47	48	42						
	700	330	0.01	2	50	43	37	31	29	25	51	47	42	33	31	28	57	51	47	37	36	32	61	53	50	40	39	35	63	55	51	42	41	37	64	59	56	45	44	40						
	600	283	0.01	2	-	39	33	29	26	-	50	45	40	31	30	26	57	49	45	35	34	31	60	53	49	38	38	33	61	55	51	40	40	36	63	59	56	44	43	40						
	400	189	0.01	2	-	35	26	-	-	-	49	41	36	28	27	24	54	47	41	32	31	30	57	52	46	35	34	32	57	52	47	37	36	34	59	54	51	41	40	39						
9	1400	661	0.01	2	51	46	46	44	37	35	52	47	46	41	38	35	57	53	49	42	37	35	64	58	53	47	41	37	66	63	57	50	43	40	69	67	61	54	47	44						
	1250	590	0.01	2	51	46	45	42	35	35	51	46	46	41	37	34	56	52	48	42	36	34	63	57	52	46	40	37	65	62	56	50	43	40	68	65	60	53	46	44						
	900	425	0.01	2	48	40	39	36	30	29	50	45	42	37	32	30	56	50	45	40	35	33	60	54	49	44	39	36	63	58	52	47	41	38	64	61	56	50	44	42						
	675	319	0.01	2	47	37	31	29	22	-	49	41	36	31	28	25	55	48	42	37	32	30	58	52	46	41	35	33	60	56	50	44	38	36	60	57	52	47	41	39						
	450	212	0.01	2	-	-	24	-	-	-	48	40	33	30	26	24	53	46	39	34	30	29	54	49	43	38	33	31	55	50	46	41	35	34	56	52	48	45	39	38						
10	1850	873	0.01	2	57	47	48	40	36	27	58	49	48	40	37	31	60	55	52	45	39	35	64	59	56	50	43	39	65	62	57	52	46	42	68	66	61	56	49	46						
	1650	779	0.01	2	55	45	45	40	35	26	57	49	46	39	36	30	59	54	51	44	38	34	63	58	55	49	42	38	64	60	56	51	45	41	67	65	60	55	48	45						
	1100	519	0.01	2	51	37	35	30	25	-	53	46	42	35	31	27	55	50	47	41	35	31	60	54	50	45	39	36	61	56	51	47	42	39	64	61	55	51	45	43						
	825	389	0.01	2	-	33	29	25	-	-	50	43	38	32	29	25	55	48	43	38	33	30	58	52	47	42	37	34	59	54	49	44	39	37	61	57	53	49	43	41						
	550	260	0.01	2	-	-	-	-	-	-	-	38	33	29	25	-	51	44	38	34	30	28	53	47	42	38	34	32	56	50	45	41	36	35	57	52	48	45	40	38						
12	2500	1180	0.01	2	57	55	54	50	42	36	60	57	53	46	41	38	63	61	54	50	42	39	66	63	57	53	45	41	67	64	59	55	48	44	70	69	63	59	52	50						
	2000	944	0.01	2	54	50	48	44	37	33	58	55	51	46	39	35	61	59	53	49	42	37	64	61	56	52	45	41	65	62	58	55	48	44	68	66	61	58	51	49						
	1600	755	0.01	2	52	45	41	36	30	27	56	52	45	40	34	30	59	56	49	46	38	35	61	58	53	49	42	39	62	60	55	51	44	42	65	64	58	55	48	46						
	1200	566	0.01	2	47	39	33	29	24	-	52	48	40	36	30	27	55	52	45	41	34	32	58	55	49	45	38	36	60	58	51	48	41	39	61	61	55	52	45	44						
	800	378	0.01	2	-	-	-	-	-	-	50	41	34	30	26	-	52	48	41	37	3																									

Performance Data • AHRI Certification and Performance Notes

Model 3210 • Without Attenuator • Non-Mixing Applications • AHRI Certification Rating Points
Fiberglass Liner

Inlet Size	Airflow		Min. Inlet ΔPs "w.g. Pa		Discharge Sound Power Levels @ 1.5" w.g. (375 Pa) ΔPs						Radiated Sound Power Levels @ 1.5" w.g. (375 Pa) ΔPs					
					Octave Band						Octave Band					
	cfm	l/s	2	3	4	5	6	7	2	3	4	5	6	7		
4	150	71	0.24	61	69	68	62	58	51	48	49	50	47	39	31	30
5	250	118	0.08	20	71	72	63	61	51	48	55	48	45	35	35	30
6	400	189	0.05	12	74	75	66	64	53	50	59	52	47	40	36	33
7	550	260	0.08	21	78	73	68	65	59	55	61	54	49	43	36	33
8	700	330	0.01	3	79	73	68	65	58	54	61	53	50	40	39	35
9	900	425	0.01	2	78	73	68	65	59	56	60	54	49	44	39	36
10	1100	519	0.01	2	77	72	68	66	59	56	60	54	50	45	39	36
12	1600	755	0.01	2	79	74	71	70	63	59	61	58	53	49	42	39
14	2100	991	0.01	2	80	74	73	72	65	60	63	61	55	48	44	43
16	2800	1321	0.05	12	82	75	72	69	63	59	65	63	57	50	44	39



Ratings are certified in accordance with AHRI Standards.

Performance Notes for Sound Power Levels:

- Discharge sound power is the noise emitted from the unit discharge into the downstream duct. Discharge Sound Power Levels (SWL) now include duct end reflection energy as part of the standard rating. Including the duct end correction provides sound power levels that would normally be transmitted into an acoustically, non-reflective duct. The effect of including the energy correction to the discharge SWL, is higher sound power levels when compared to previous AHRI certified data. For more information on duct end reflection calculations see AHRI Standard 880.
- Radiated sound power is the breakout noise transmitted through the unit casing walls.
- Sound power levels are in decibels, dB re 10⁻¹² watts.
- All sound data listed by octave bands is raw data without any corrections for room absorption or duct attenuation. Dash (-) in space indicates sound power level is less than 20 dB or equal to background.
- Minimum inlet ΔPs is the minimum operating pressure requirement of the unit (damper full open) and the difference in static pressure from inlet to discharge of the unit.
- Asterisk (*) in space indicates that the minimum inlet static pressure requirement is greater than 0.5" w.g. (125 Pa) at rated airflow.
- Data derived from independent tests conducted in accordance with ANSI/ASHRAE Standard 130 and AHRI Standard 880.

B
DUAL DUCT TERMINAL UNITS

**DUAL DUCT
VARIABLE OR CONSTANT
AIR VOLUME**

**3200 SERIES
• 1:12 MIXING**

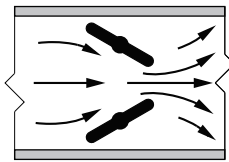

Opposed blade damper configuration minimizes noisy turbulence and provides smooth, accurate, near linear flow control.

Model:

3230 With Compact Mixing Attenuator



Model 3230

When blending of hot and cold air is required, the Model 3230 comes with an integral compact mixing attenuator section which attenuates discharge noise and through the use of internal baffles, mixing of the hot and cold airstreams. The compact design of the 3230 lends itself to applications where there are tight space limitations, while still meeting or exceeding industry standard sound and mixing requirements. Minimum mixing efficiency is 1 in 12. That means there is less than a 1°F (0.55°C) temperature variation at the discharge for each 12°F (6.66°C) temperature difference between the hot and cold decks.

STANDARD FEATURES:

- 22 ga. (0.86) zinc coated steel casing, mechanically sealed, low leakage construction.
- Extra-low leakage opposed blade dampers with blade and jamb seals (single blade on size 4, 5, 6). 90° rotation, CW to close. Damper leakage is less than 1% of normal rated airflow at 6" w.g. (1.5 kPa).
- 1/2" (13) dia. plated steel driveshaft. An indicator mark on the end of the shaft shows damper position.
- Integral mixing attenuator with baffles. 1:12 minimum mixing efficiency.
- Rectangular discharge.
- Full NEMA 1 type enclosure for factory mounted controls.
- 3/4" (19), dual density insulation, exposed edges coated to prevent air erosion. Meets the requirements of NFPA 90A and UL 181.
- Two multi-point averaging Diamond

- Flow Sensors. Aluminum construction. Supplied with balancing tees. Location must be specified based upon control sequence. Choice of location:
 - Cold and hot duct inlet.
 - Hot duct inlet and downstream total discharge.
 - Cold duct inlet and downstream total discharge.
- Choice of right or left-hand cold duct location. Hand of unit is determined by location of cold duct looking in direction of airflow. Right-hand unit illustrated. Unit is flippable.
- Unequal inlet sizes are available. Casing is governed by the larger inlet size.
- Tested and certified to AHRI Standard 880 using Steri-Liner insulation, the preferred choice for IAQ dual duct applications.

Controls:

- Digital (supplied by others).
- Analog (by Nailor).

Options:

- 24 VAC Control transformer.
- Toggle disconnect switch.
- Steri-liner.
- Fiber-free liner.
- Solid metal liner.
- Perforated metal liner.
- 1" (25) liner.
- Bottom access door (Model 0800-M1).
- Controls enclosure for field or factory mounted controls.
- Dust tight enclosure seal.
- Hanger brackets.
- Access door.
- Seismic Certification.



Intertek



Dimensions

Model 3230 • Compact Mixing Attenuator • Mixing Application

- Variable or constant volume operation.
- Rectangular discharge collar optimally sized for duct run out.
- Integral mixing attenuator construction reduces insulation seams and reduces casing leakage.
- Multi-point Diamond Flow Sensor available in three location configurations to suit exact control sequence requirement.
- Solid mixing baffles standard.
- Unique low leakage opposed blade dampers control each deck independently. 90° rotation. CW to close.
- Right hand and left hand are flippable.
- When unequal sized inlets are used, the casing will be governed by the larger inlet size.
- Choice of right or left hand cold deck location. Hand of unit is determined by location of cold deck looking in direction of airflow. Right hand unit illustrated.

Pneumatic Controls

• Universal pneumatic control mounting panel features double wall stand-off construction for strength and rigidity. Controls mounting screws do not penetrate casing.

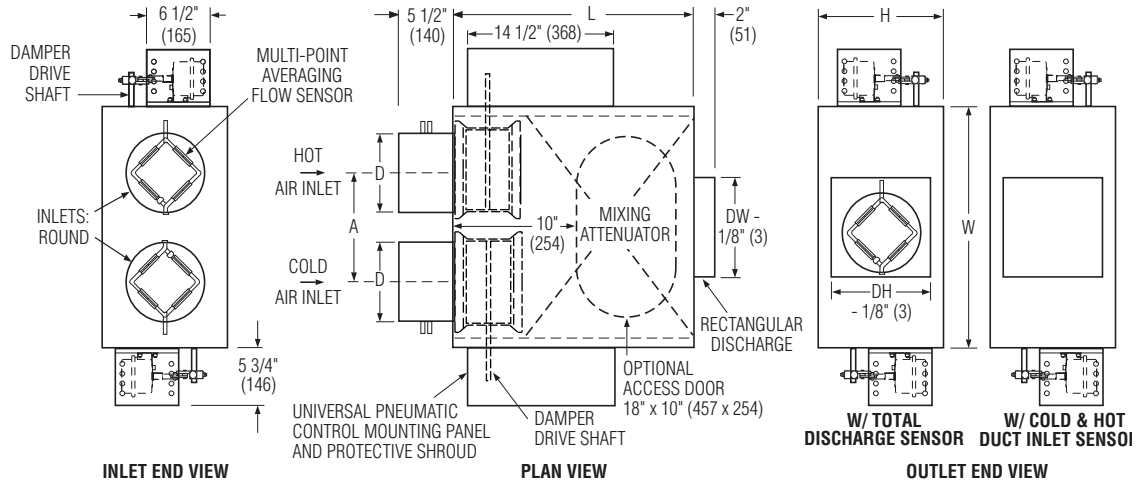

Analog Electronic and Digital Controls

• A full NEMA 1 controls enclosure is provided for factory mounted controls. Optional for field mounted controls.

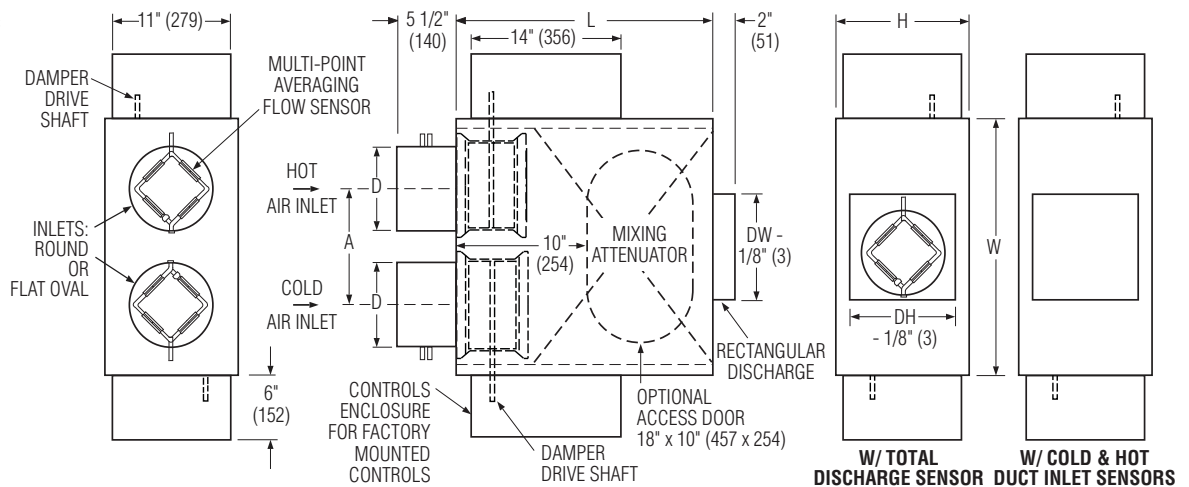

Dimensional Data

Unit Size	W	H	L	A	Inlet Dia. D	Outlet DW x DH
4	24 (610)	10 (254)	24 (610)	11 (279)	3 7/8 (98)	
5	24 (610)	10 (254)	24 (610)	11 (279)	4 7/8 (124)	8 x 8 (203 x 203)
6	24 (610)	10 (254)	24 (610)	11 (279)	5 7/8 (149)	
7	24 (610)	12 1/2 (318)	24 (610)	11 (279)	6 7/8 (175)	10 x 10 (254 x 254)
8	24 (610)	12 1/2 (318)	24 (610)	11 (279)	7 7/8 (200)	
9	34 (864)	14 (356)	34 (864)	16 1/8 (410)	8 7/8 (225)	14 x 12 (356 x 305)
10	34 (864)	14 (356)	34 (864)	16 1/8 (410)	9 7/8 (251)	
12	34 (864)	16 (406)	34 (864)	16 1/8 (410)	11 7/8 (302)	18 x 14 (457 x 356)
14	42 (1067)	18 (457)	38 (965)	20 1/8 (511)	13 7/8 (353)	22 x 16 (559 x 406)
16	42 (1067)	18 (457)	38 (965)	20 1/8 (511)	15 7/8 (403)	24 x 18 (610 x 457)

Recommended Airflow Ranges For Model 3230 Dual Duct Pressure Independent Terminal Units

The recommended airflow ranges below are for dual duct terminal units with pressure independent controls and are presented as ranges for total and controller specific minimum and maximum airflow. Airflow ranges are based upon maintaining reasonable sound levels and controller limits using Nailor's Diamond Flow Sensor as the airflow measuring device. For a given unit size, the minimum, auxiliary minimum (where applicable) and the maximum flow setting must be within the range limits to ensure pressure independent operation, accuracy and repeatability.

Minimum airflow limits are based upon .02" w.g. (5 Pa) differential pressure signal from Diamond Flow Sensor on analog/digital controls and .03" (7.5) for pneumatic controllers. This is a realistic low limit for many transducers used in the digital controls industry. Check your controls supplier for minimum limits. Setting airflow minimums lower, may cause hunting and failure to meet minimum ventilation requirements Where an auxiliary setting is specified, the value must be greater than the minimum setting.

The high end of the tabulated Total Airflow Range on pneumatic and analog electronic controls represents the Diamond Flow Sensor's differential pressure reading at 1" w.g. (250 Pa). The high end airflow range for digital controls is represented by the indicated transducer differential pressure.

ASHRAE 130 "Performance Rating of Air Terminals" is the method of test for the certification program. The "standard rating condition" (certification rating point) airflow volumes for each terminal unit size are tabulated below per AHRI Standard 880. These air volumes equate to an approximate inlet velocity of 2000 fpm (10.2 m/s).

When digital or other controls are mounted by Nailor, but supplied by others, these values are guidelines only, based upon experience with the majority of controls currently available. Controls supplied by others for factory mounting are configured and calibrated in the field. Airflow settings on pneumatic and analog controls supplied by Nailor are factory preset when provided.

Imperial Units, Cubic Feet per Minute

Unit Size	Inlet Type	Total Airflow Range, cfm	Airflow at 2000 fpm Inlet Velocity (nom.), cfm	Range of Minimum and Maximum Settings, cfm							
				Pneumatic 3000 Controller		Analog Electronic Controls		Digital Controls			
				Transducer Differential Pressure ("w.g.)							
				Min.	Max.	Min.	Max.	Min.	Max.		
4	Round	0 – 225	150	30	180	25	180	25	180	200	225
5		0 – 400	250	55	325	45	325	45	325	360	400
6		0 – 550	400	80	450	65	450	65	450	500	550
7		0 – 800	550	115	650	95	650	95	650	725	800
8		0 – 1100	700	155	900	125	900	125	900	1000	1100
9		0 – 1400	900	200	1150	165	1150	165	1150	1285	1400
10		0 – 1840	1100	260	1500	215	1500	215	1500	1675	1840
12		0 – 2500	1600	355	2050	290	2050	290	2050	2290	2500
14		0 – 3370	2100	475	2740	390	2740	390	2740	3075	3370
16		0 – 4510	2800	640	3680	520	3680	520	3680	4120	4510

Metric Units, Liters per Second

Unit Size	Inlet Type	Total Airflow Range, l/s	Airflow at 10.2 m/s Inlet Velocity (nom.), l/s	Range of Minimum and Maximum Settings, l/s							
				Pneumatic 3000 Controller		Analog Electronic Controls		Digital Controls			
				Transducer Differential Pressure (Pa)							
				Min.	Max.	Min.	Max.	Min.	Max.		
4	Round	0 – 106	71	14	85	12	85	12	85	94	106
5		0 – 189	118	26	153	21	153	21	153	170	189
6		0 – 260	189	38	212	31	212	31	212	236	260
7		0 – 378	260	54	307	45	307	45	307	342	378
8		0 – 519	330	73	425	59	425	59	425	472	519
9		0 – 661	425	94	543	78	543	78	543	606	661
10		0 – 868	519	123	708	101	708	101	708	790	868
12		0 – 1180	755	168	967	137	967	137	967	1081	1080
14		0 – 1590	991	224	1298	184	1298	184	1298	1451	1590
16		0 – 2128	1321	302	1746	245	1746	245	1746	1944	2128

Performance Data • NC Level Application Guide
Model 3230 • With Mixing Attenuator
Steri-Liner

B
DUAL DUCT TERMINAL UNITS

Inlet Size	Airflow cfm / s		Min. inlet ΔPs "w.g. Pa		NC Levels @ Inlet Pressure (ΔPs) shown											
					DISCHARGE					RADIATED						
					Min. ΔPs	0.5" w.g. (125 Pa)	1.0" w.g. (250 Pa)	1.5" w.g. (375 Pa)	2.0" w.g. (500 Pa)	3.0" w.g. (750 Pa)	Min. ΔPs	0.5" w.g. (125 Pa)	1.0" w.g. (250 Pa)	1.5" w.g. (375 Pa)	2.0" w.g. (500 Pa)	3.0" w.g. (750 Pa)
4	200	94	0.51	126	21	*	29	33	34	36	-	*	-	-	-	21
	150	71	0.29	71	-	-	25	31	30	31	27	-	-	-	-	-
	100	47	0.13	32	-	-	23	20	23	21	-	-	-	-	-	20
	25	12	0.01	2	-	-	-	-	-	-	-	-	-	-	-	20
5	350	165	0.42	104	24	25	30	34	36	38	-	28	34	36	38	40
	250	118	0.22	55	-	23	28	33	34	37	-	-	-	-	20	23
	150	71	0.08	21	-	-	24	25	28	29	-	-	-	-	-	20
	50	24	0.01	2	-	-	-	-	-	-	-	-	-	-	-	-
6	550	260	0.67	165	31	*	35	39	41	46	25	*	39	43	44	45
	400	189	0.36	89	21	25	31	37	39	43	-	-	23	28	28	31
	250	118	0.14	35	-	21	26	33	35	38	-	-	-	20	22	24
	75	35	0.02	4	-	-	-	-	21	24	-	-	-	-	-	-
7	750	354	0.66	165	35	*	41	48	49	51	-	*	33	39	44	50
	550	260	0.41	101	25	33	39	41	45	50	-	-	29	35	39	45
	350	165	0.20	49	-	26	34	38	38	36	-	-	28	33	36	39
	100	47	0.03	7	-	-	-	-	-	-	-	-	20	20	21	23
8	950	448	0.87	217	40	*	43	48	51	55	25	*	38	41	45	46
	700	330	0.48	119	31	31	40	45	45	50	20	23	33	38	43	49
	450	212	0.20	50	-	23	29	34	36	34	22	28	31	33	35	36
	125	59	0.02	4	-	-	-	-	-	20	-	21	-	20	20	-
9	1200	566	0.43	107	29	34	41	48	51	56	21	34	35	39	44	49
	900	425	0.25	61	-	31	39	45	46	50	-	21	33	37	40	46
	600	283	0.11	28	-	29	36	37	37	34	-	-	25	29	33	35
	175	83	0.01	2	-	-	-	-	-	-	-	-	-	-	-	-
10	1600	755	0.58	145	36	*	39	45	49	56	30	*	37	43	46	51
	1100	519	0.28	71	21	26	38	44	46	53	16	23	34	38	41	48
	600	283	0.09	22	-	24	33	35	34	31	-	-	25	29	31	34
	225	106	0.01	2	-	-	-	-	-	-	-	-	-	-	-	-
12	2200	1038	0.87	215	43	*	43	48	52	56	33	*	35	40	44	51
	1600	755	0.46	114	34	33	40	45	49	54	21	23	31	37	40	46
	1000	472	0.18	44	-	21	33	38	38	38	-	-	28	31	35	39
	300	142	0.02	4	-	-	-	-	-	-	-	-	-	-	20	21
14	2900	1369	0.76	189	41	*	44	46	48	50	30	*	30	34	38	43
	2100	991	0.39	97	30	33	36	40	43	46	20	21	26	31	35	38
	1300	613	0.14	36	-	24	30	35	38	41	-	-	21	29	30	33
	400	189	0.01	2	-	-	-	20	21	25	-	-	-	20	-	25
16	4350	2053	1.54	384	53	*	-	-	53	56	43	*	-	-	41	48
	3550	1675	1.03	257	45	*	-	48	49	52	35	*	-	36	38	44
	2750	1298	0.63	155	35	*	40	43	45	48	25	*	28	33	36	41
	1950	920	0.32	79	24	28	34	38	40	44	-	-	25	29	31	36
1150	543	0.11	28	-	24	30	35	38	43	-	-	-	23	24	28	

Performance Notes:

1. NC Levels are calculated based on procedures as documented on page B25.
2. Dash (-) in space indicates a NC less than 20.
3. Asterisk (*) in space indicates that the minimum inlet static pressure requirement is greater than 0.5" w.g. (125 Pa) at rated airflow.

Performance Data • Discharge Sound Power Levels

Model Series 3230 • With Mixing Attenuator

Steri-Liner



Inlet Size	Airflow		Min. inlet ΔPs		Sound Power Octave Bands @ Inlet Pressure (ΔPs) shown																																									
					Minimum ΔPs							0.5" w.g. (125Pa) ΔPs							1.0" w.g. (250Pa) ΔPs							1.5" w.g. (375Pa) ΔPs							2.0" w.g. (500Pa) ΔPs							3.0" w.g. (750Pa) ΔPs						
					2	3	4	5	6	7	2	3	4	5	6	7	2	3	4	5	6	7	2	3	4	5	6	7	2	3	4	5	6	7	2	3	4	5	6	7						
4	200	94	0.51	126	64	62	51	40	35	39	*	*	*	*	*	*	69	68	54	48	41	41	70	71	57	52	46	44	70	72	60	54	50	47	72	74	64	57	54	52						
	150	71	0.29	71	61	56	43	32	27	31	63	59	46	38	31	32	65	65	52	46	40	39	67	70	58	50	46	44	67	69	60	52	48	46	68	70	62	56	53	51						
	100	47	0.13	32	60	49	32	-	-	-	61	58	43	37	30	27	61	63	51	44	39	37	62	61	54	46	43	41	64	63	56	49	46	45	61	62	57	50	48	48						
	25	12	0.01	2	57	44	-	-	-	-	58	49	34	25	23	25	57	46	34	27	25	34	59	50	40	32	32	36	60	50	42	33	37	38	61	50	43	33	38	41						
5	350	165	0.42	104	67	65	52	44	39	40	69	66	53	46	39	40	72	70	57	50	44	43	74	73	60	54	48	46	75	75	62	56	51	49	77	77	66	59	55	54						
	250	118	0.22	55	61	56	43	34	29	29	63	63	46	40	34	32	68	67	53	47	41	40	71	71	58	51	47	45	71	72	60	52	49	47	74	75	64	56	53	51						
	150	71	0.08	21	58	47	29	-	-	-	62	58	42	37	30	28	63	64	49	43	38	36	65	65	56	46	42	40	66	67	59	49	45	43	68	68	60	54	50	48						
6	50	24	0.01	2	56	43	-	-	-	-	57	51	39	27	23	24	58	53	47	40	38	39	59	51	45	37	35	36	58	53	47	39	38	39	58	54	49	41	41	44						
	550	260	0.67	165	75	71	60	50	45	44	*	*	*	*	*	*	77	74	63	53	48	46	80	78	66	57	52	49	81	80	68	58	53	51	83	84	72	61	57	55						
	400	189	0.36	89	66	63	51	41	36	33	69	66	54	43	38	36	74	71	59	49	44	41	77	76	63	54	49	46	78	78	65	55	51	49	80	81	69	58	55	53						
	250	118	0.14	35	62	51	39	28	21	-	65	60	47	38	32	29	69	66	54	44	39	38	72	71	59	48	45	43	72	73	61	49	47	46	75	76	64	53	51	50						
7	75	35	0.02	4	39	20	-	-	-	-	55	45	29	25	-	-	55	52	40	29	24	23	60	59	47	33	33	32	60	62	50	34	36	37	63	64	52	39	41	41						
	750	354	0.66	165	78	75	62	54	51	49	*	*	*	*	*	*	82	81	71	57	53	50	87	86	75	63	60	58	87	87	76	65	62	61	88	89	79	68	66	65						
	550	260	0.41	101	70	66	54	46	43	40	74	72	60	47	43	39	80	78	67	55	52	50	82	80	71	60	57	56	83	83	74	61	59	58	84	87	77	65	62	61						
	350	165	0.20	49	59	54	42	33	29	24	69	67	57	45	41	38	74	73	64	51	48	46	75	77	68	55	52	51	74	77	68	56	53	53	74	75	68	56	53	53						
8	100	47	0.03	7	52	40	-	-	-	-	54	48	37	26	30	24	54	51	43	33	36	41	56	55	47	37	42	42	56	55	47	37	44	45	56	56	48	38	45	50						
	950	448	0.87	217	81	80	65	57	54	50	*	*	*	*	*	*	83	82	67	58	54	51	87	86	74	62	59	56	88	89	76	64	61	59	92	92	79	68	66	64						
	700	330	0.48	119	74	71	57	48	45	41	74	71	57	48	45	41	81	79	66	54	51	48	85	83	71	59	57	55	87	83	73	61	59	57	88	87	76	64	62	61						
	450	212	0.20	50	55	52	43	35	31	25	64	64	55	44	41	38	68	69	62	50	48	46	72	73	66	54	53	51	72	75	68	57	55	54	70	73	68	59	57	55						
9	125	59	0.02	4	55	43	-	-	-	-	57	48	38	25	23	22	57	53	44	33	33	32	59	58	49	37	38	39	60	58	49	37	38	39	60	61	53	39	40	42						
	1200	566	0.43	107	76	69	58	48	46	44	78	74	60	49	47	45	84	81	67	55	53	52	89	86	71	60	58	57	91	89	73	62	61	59	94	93	77	65	64	63						
	900	425	0.25	61	68	60	50	40	38	34	75	72	58	46	44	41	82	79	64	53	51	49	87	84	69	57	56	55	88	85	70	59	57	56	89	88	73	61	60	60						
	600	283	0.11	28	60	50	39	28	24	20	71	69	54	42	40	38	78	75	60	49	47	46	79	76	62	51	50	49	78	76	62	52	51	50	76	73	61	53	52	53						
10	175	83	0.01	2	54	42	-	-	-	-	55	46	31	23	22	24	54	48	36	29	28	32	57	51	40	35	35	37	57	51	40	36	38	42	60	57	45	37	41	48						
	1600	755	0.58	145	82	73	65	55	53	52	*	*	*	*	*	*	84	77	67	57	55	53	88	84	73	61	59	58	91	87	75	63	62	60	96	93	79	68	66	65						
	1100	519	0.28	71	70	61	53	44	41	38	72	68	56	46	44	40	82	78	65	53	51	49	88	83	70	58	56	55	89	85	73	61	59	58	91	90	77	64	63	62						
	600	283	0.09	22	57	46	36	25	20	-	70	65	52	41	38	36	76	72	59	47	45	44	78	74	62	50	48	48	77	73	62	50	49	49	75	71	61	52	51	52						
12	225	106	0.01	2	55	43	-	-	-	-	57	48	35	26	24	25	57	50	41	32	30	36	59	53	44	36	37	41	60	54	46	38	39	43	61	57	49	41	43	48						
	2200	1038	0.87	215	87	80	69	60	57	54	*	*	*	*	*	*	87	80	69	59	57	54	91	84	72	63	60	58	94	88	75	64	63	61	97	92	79	68	68	66						
	1600	755	0.46	114	80	70	60	50	47	44	79	71	60	51	48	44	85	78	65	55	53	50	89	84	70	59	58	56	91	87	73	62	61	59	93	91	78	66	66	65						
	1000	472	0.18	44	62	53	46	37	33	28	70	64	54	44	42	38	77	73	62	51	50	48	80	78	68	56	55	54	81	78	68	56	56	55	80	78	69	58	59	58						
14	300	142	0.02	4	52	40	-	-	-	-	57	50	38	27	26	25	58	53	44	34	34	33	61	56	49	39	40	40	61	56	50	41	42	44	63	59	53	44	47	50						
	2900	1369	0.76	189	86	75	67	59	56	53	*	*	*	*	*	*	88	78	70	62	59	56	90	82	72	65	62	59	91	83	73	65	62	60	93	86	75	67	65	64						
	2100	991	0.39	97	77	66	58	50	47	42	79	68	60	52	49	46	82	73	63	55	53	50	85	78	67	58	57	55	87	80	68	60	58	57	90	83	72	63	63	62						
	1300	613	0.14	36	63	53	45	36	31	25	72	62	52	44	41	38	77	69	57	49	48	46	81	74	62	53	52	52	83	76	65	55	55	54	86	80	69	59	60	60						
16	400	189	0.01	2	54	38	-	-	-	-	59	52	41	32	30	29	65	59	47	39	38	39	66	62	51	44	44	45	67	63	52	45	46	47	69	66	55	45	48	52						
	4350	2053	1.54	384	95	87	78	70	67	64	*	*	*	*	*	*	*	*	*	*	*	*	*	*	*	*	*	*	95	88	79	71	68	66	97	90	81	73	71	68						
	3550	1675	1.03	257	89	81	71	63	60	57	*	*	*	*	*	*	*	*	*	*	*	*	*	*	*	*	*	*	92	85	75	67	64	62	94	88	78	70	68	66						
	2750	1298	0.63	155	81	72	62	54	51	48	*	*	*	*	*	*	85	76	67	59	56	53	87	80	70	62	59	57	89	82	71	63	61	60	91	85	74	66	65	64						
16	1950	920	0.32	79	72	61	52	44	40	36	75	66	57	49	46	43	80	72	62	54	52	50	83																							

Performance Data • Radiated Sound Power Levels

Model 3230 • With Mixing Attenuator
Steri-Liner



B
DUAL DUCT TERMINAL UNITS

Inlet Size	Airflow		Min. inlet ΔPs		Sound Power Octave Bands @ Inlet Pressure (ΔPs) shown																																									
					Minimum ΔPs							0.5" w.g. (125Pa) ΔPs							1.0" w.g. (250Pa) ΔPs							1.5" w.g. (375Pa) ΔPs							2.0" w.g. (500Pa) ΔPs							3.0" w.g. (750Pa) ΔPs						
					2	3	4	5	6	7	2	3	4	5	6	7	2	3	4	5	6	7	2	3	4	5	6	7	2	3	4	5	6	7	2	3	4	5	6	7						
4	200	94	0.51	126	-	34	32	26	28	-	*	*	*	*	*	*	53	47	39	31	29	27	53	49	41	32	32	33	55	51	43	34	34	35	56	53	46	38	36	37						
	150	71	0.29	71	-	32	29	23	57	-	47	40	32	25	24	-	51	45	36	28	25	24	51	47	38	29	28	30	53	29	42	31	30	32	54	51	45	37	32	34						
	100	47	0.13	32	-	-	27	24	23	-	45	38	29	22	-	-	47	41	33	24	24	25	48	45	37	26	25	33	47	44	42	30	25	30	48	47	46	39	30	34						
	25	12	0.01	2	-	-	-	-	-	-	37	30	17	-	-	-	35	29	-	-	-	-	38	37	29	14	11	33	31	29	40	-	-	-	32	35	46	41	-	28						
5	350	165	0.42	104	25	46	43	36	29	-	64	46	39	39	37	-	69	51	44	37	39	35	71	55	46	37	37	35	72	56	48	38	38	37	74	59	52	43	40	39						
	250	118	0.22	55	-	35	34	28	30	-	50	43	37	30	30	-	54	48	41	33	31	28	54	50	43	34	34	34	56	52	45	36	36	36	57	54	48	40	38	38						
	150	71	0.08	21	-	-	23	-	-	-	36	40	36	21	-	-	38	45	39	29	21	-	39	47	42	32	30	32	39	48	44	34	32	33	40	50	46	38	34	37						
	50	24	0.01	2	-	-	-	-	-	-	-	33	31	-	-	-	-	38	32	-	-	-	-	37	36	26	-	28	-	37	37	29	23	28	-	38	38	32	27	33						
6	550	260	0.67	165	48	52	51	43	42	28	*	*	*	*	*	*	73	56	50	43	45	40	76	61	52	43	42	39	77	62	54	44	43	40	78	65	57	47	46	44						
	400	189	0.36	89	49	43	39	34	32	28	56	49	45	37	32	27	59	54	48	39	36	32	62	58	51	42	40	36	62	58	51	41	41	39	64	61	53	44	43	43						
	250	118	0.14	35	-	24	29	25	25	-	41	44	38	27	24	-	44	49	44	34	27	24	45	52	46	37	35	35	45	52	48	39	37	36	46	54	50	42	39	40						
	75	35	0.02	4	-	-	-	-	-	-	-	33	23	-	-	-	-	38	34	20	-	-	-	38	37	28	23	29	-	38	38	30	26	30	-	38	39	34	30	34						
7	750	354	0.66	165	53	48	44	33	27	-	*	*	*	*	*	*	66	62	51	41	36	32	70	68	58	45	42	37	72	72	62	50	46	41	76	77	66	53	50	46						
	550	260	0.41	101	54	49	39	33	27	-	53	51	40	34	29	25	63	59	47	38	33	29	67	64	54	42	39	35	69	68	58	46	43	38	73	73	62	49	47	43						
	350	165	0.20	49	26	24	24	-	-	-	53	50	40	30	-	-	61	58	47	36	32	29	63	62	52	39	36	33	65	65	55	42	39	35	67	68	58	45	43	40						
	100	47	0.03	7	-	-	-	-	-	-	48	45	35	-	-	-	53	52	42	28	26	24	51	52	42	28	26	25	52	53	43	30	28	26	53	54	45	32	31	30						
8	950	448	0.87	217	62	51	44	33	41	32	*	*	*	*	*	*	64	62	51	41	36	32	70	68	58	45	42	37	74	74	63	52	48	43	79	79	68	56	53	49						
	700	330	0.48	119	57	52	42	36	30	-	56	54	43	37	32	28	66	62	50	41	36	32	70	67	57	45	42	38	72	71	61	49	46	41	76	76	65	52	50	46						
	450	212	0.20	50	29	28	-	-	-	55	52	41	32	25	-	62	60	50	38	34	30	65	64	53	41	38	34	67	67	57	44	41	37	69	71	60	48	45	42	40						
	125	59	0.02	4	-	-	-	-	-	48	46	36	-	-	-	54	54	45	29	27	23	52	53	44	30	28	26	53	55	46	32	30	27	53	55	46	33	32	30	38						
9	1200	566	0.43	107	59	53	45	42	48	36	69	54	45	42	32	26	67	64	52	46	39	34	72	68	56	49	42	37	75	72	60	52	45	40	76	76	62	55	48	45						
	900	425	0.25	61	54	48	41	38	32	24	57	53	43	41	35	29	65	62	50	45	39	34	69	66	54	47	42	37	72	69	57	50	45	40	74	74	61	54	48	45						
	600	283	0.11	28	43	38	32	29	-	-	45	49	39	35	-	-	59	56	45	39	34	30	62	59	48	42	36	33	64	62	51	45	40	36	64	64	53	47	42	40						
	175	83	0.01	2	-	-	-	-	-	-	-	40	28	22	-	-	44	42	31	27	23	23	43	44	34	29	26	25	44	45	36	33	30	29	44	44	38	33	32	31						
10	1600	755	0.58	145	65	60	52	49	56	46	*	*	*	*	*	*	70	66	55	49	43	37	74	71	59	52	47	40	78	74	62	55	48	43	80	78	66	58	51	47						
	1100	519	0.28	71	55	49	42	39	33	25	58	54	44	42	36	30	66	63	51	46	40	35	70	67	55	48	43	38	73	70	58	51	46	41	75	75	62	55	49	46						
	600	283	0.09	22	37	32	26	23	-	-	39	48	38	34	-	-	58	56	44	39	34	31	61	59	48	42	37	33	62	61	50	45	40	37	63	63	53	47	42	40						
	225	106	0.01	2	-	-	-	-	-	-	-	41	29	23	-	-	46	45	34	29	25	24	47	47	37	31	27	26	47	48	38	35	32	30	47	48	40	36	34	33						
12	2200	1038	0.87	215	67	62	54	53	50	54	*	*	*	*	*	*	68	64	53	51	48	41	73	69	57	52	49	44	76	72	60	53	50	46	80	78	64	55	52	50						
	1600	755	0.46	114	58	53	47	46	41	33	59	54	47	46	41	33	65	61	50	48	44	37	71	66	54	49	46	42	73	69	57	50	47	44	76	74	61	53	49	48						
	1000	472	0.18	44	45	42	37	34	26	-	47	50	41	38	30	-	62	58	47	42	38	35	65	61	50	44	40	38	67	64	52	46	42	41	69	68	55	50	45	45						
	300	142	0.02	4	-	-	-	-	-	-	-	39	26	-	-	-	51	49	37	29	24	26	52	50	39	32	27	29	52	52	40	35	29	32	53	53	42	42	35	37						
14	2900	1369	0.76	189	66	58	50	42	37	41	*	*	*	*	*	*	66	60	51	41	38	36	69	63	56	45	43	40	72	66	59	48	46	44	73	71	63	51	50	49						
	2100	991	0.39	97	58	49	42	36	31	28	59	50	43	36	31	29	63	57	49	39	36	34	66	61	54	43	41	39	68	64	57	45	44	42	70	67	60	49	47	46						
	1300	613	0.14	36	46	35	30	25	24	-	-	47	40	31	24	22	59	53	47	37	35	33	62	59	51	40	38	38	61	60	53	41	40	39	68	60	56	47	43	42						
	400	189	0.01	2	-	-	-	-	-	-	-	40	33	-	-	-	48	44	40	30	30	28	51	52	44	33	31	36	46	51	44	32	31	32	62	45	47	40	34	33						
16	4350	2053	1.54	384	73	71	63	56	52	46	*	*	*	*	*	*	*	*	*	*	*	*	*	*	*	*	*	*	74	70	57	53	50	46	77	75	62	56	53	50						
	3550	1675	1.03	257	68	64	56	50	46	40	*	*	*	*	*	*	*	*	*	*	*	*	*	*	*	*	*	*	72	67	56	51	48	45	75	72	61	54	51	49						
	2750	1298	0.63	155	62	56	47	43	40	36	*	*	*	*	*	*	64	58	48	43	42	38	68	62	51	46	43	40	70	65	54	49	45	42	73	70	58	52	49	46						
	1950	920	0.32	79	54	44	37	33	30	23	56	47	39	43	36	29	61	56	46	40	38	35	64	59	49	43	41	40	66	61	52	46	43	42	69	65	55	49	46	46						
1150	543	0.11	28	42	27	19	17	15																																						

Performance Data • AHRI Certification and Performance Notes

Model 3230 • With Mixing Attenuator • AHRI Certification Rating Points

Steri-Liner

Inlet Size	Airflow		Min. Inlet ΔPs		Discharge Sound Power Levels @ 1.5" w.g. (375 Pa) ΔPs							Radiated Sound Power Levels @ 1.5" w.g. (375 Pa) ΔPs						
					Octave Band							Octave Band						
	cfm	l/s	"w.g.	Pa	2	3	4	5	6	7	2	3	4	5	6	7		
4	150	71	0.29	71	67	70	58	50	46	44	51	47	38	29	28	30		
5	250	118	0.22	55	71	71	58	51	47	45	54	50	43	34	34	34		
6	400	189	0.36	89	77	76	63	54	49	46	62	58	51	42	40	36		
7	550	260	0.41	101	82	80	71	60	57	56	67	64	54	42	39	35		
8	700	330	0.48	119	85	83	71	59	57	55	70	67	57	45	42	38		
9	900	425	0.25	61	87	84	69	57	56	55	69	66	54	47	42	37		
10	1100	519	0.28	71	88	83	70	58	56	55	70	67	55	48	43	38		
12	1600	755	0.46	114	89	84	70	59	58	56	71	66	54	49	46	42		
14	2100	991	0.39	97	85	78	67	58	57	55	66	61	54	43	41	39		
16	2750	1298	0.63	155	87	80	70	62	59	57	68	62	51	46	43	40		



Ratings are certified in accordance with AHRI Standards.

Performance Notes for Sound Power Levels:

- Discharge sound power is the noise emitted from the unit discharge into the downstream duct. Discharge Sound Power Levels (SWL) now include duct end reflection energy as part of the standard rating. Including the duct end correction provides sound power levels that would normally be transmitted into an acoustically, non-reflective duct. The effect of including the energy correction to the discharge SWL, is higher sound power levels when compared to previous AHRI certified data. For more information on duct end reflection calculations see AHRI Standard 880.
- Radiated sound power is the breakout noise transmitted through the unit casing walls.
- Sound power levels are in decibels, dB re 10⁻¹² watts.
- All sound data listed by octave bands is raw data without any corrections for room absorption or duct attenuation. Dash (-) in space indicates sound power level is less than 20 dB or equal to background.
- Minimum inlet ΔPs is the minimum operating pressure requirement of the unit (damper full open) and the difference in static pressure from inlet to discharge of the unit.
- Asterisk (*) in space indicates that the minimum inlet static pressure requirement is greater than 0.5" w.g. (125 Pa) at rated airflow.
- Data derived from independent tests conducted in accordance with ANSI/ASHRAE Standard 130 and AHRI Standard 880.

DUAL DUCT VARIABLE OR CONSTANT AIR VOLUME

3230HQ

- HOSPITAL GRADE
- DISSIPATIVE SILENCER
- SUPER QUIET
- 1:12 MIXING

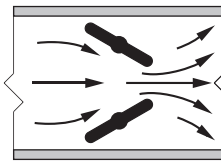

Opposed blade damper configuration minimizes noisy turbulence and provides smooth, accurate, near linear flow control.



Model 3230HQ

**Steri-Liner
Performance
Tested**

Model:

**3230HQ With Compact
Mixing Attenuator
and Dissipative
Silencer**

When blending of hot and cold air is required, the Model 3230HQ comes with an integral compact mixing attenuator section which attenuates discharge noise and through the use of internal baffles, mixing of the hot and cold airstreams. Minimum mixing efficiency is 1 in 12. That means there is less than a 1°F (0.55°C) temperature variation at the discharge for each 12°F (6.66°C) temperature difference between the hot and cold decks. The 3230HQ adds a close coupled factory mounted dissipative discharge silencer for sound sensitive applications. The silencer has been carefully designed and tested to optimize performance as an integral assembly. This eliminates the guess work and possible problems (excessive pressure drop and self-generated noise) associated with field supplied silencers.

STANDARD FEATURES:

- Designed for hospital and other critical environment applications where IAQ (Indoor Air Quality) is a concern.
- 22 ga. (0.86) zinc coated steel casing, mechanically sealed, low leakage construction.
- Extra-low leakage opposed blade dampers with blade and jamb seals (single blade on size 4, 5, 6). 90° rotation, CW to close. Damper leakage is less than 1% of normal rated airflow at 6" w.g. (1.5 kPa).
- 1/2" (13) dia. plated steel driveshaft. An indicator mark on the end of the shaft shows damper position.
- Integral mixing attenuator with baffles. 1:12 minimum mixing efficiency.
- Rectangular discharge.
- Full NEMA 1 type enclosure for factory mounted controls.
- VAV section is lined with 13/16" (21) thick, 4 lb. density Steri-Liner insulation. Fiberglass with a reinforced aluminum FSK facing. Meets the requirements of NFPA 90A, UL 181 and ASTM C655.
- Two multi-point averaging Diamond

Flow Sensors. Aluminum construction. Supplied with balancing tees. Location must be specified based upon control sequence. Choice of location:

- Cold and hot duct inlet.
- Hot duct inlet and downstream total discharge.
- Cold duct inlet and downstream total discharge.

- Choice of right or left-hand cold duct location. Hand of unit is determined by location of cold duct looking in direction of airflow. Right-hand unit illustrated. Unit is flippable.

- Unequal inlet sizes are available. Casing is governed by the larger inlet size.

Silencer Section:

- Designed to mate with VAV section for optimum performance and super quiet operation.
- Optimized internal baffle geometry reduces self-generated noise, minimizes pressure drop and maximizes acoustic attenuation.
- 22 ga. (0.86) coated steel perforated baffles encapsulate fiberglass acoustic media. Mylar lining with acoustical spacer isolates material from airstream.

- Integral Steri-Liner insulation on top and bottom optimize sound reduction and eliminate the need for external field applied duct wrap.

Digital Controls:

- Factory Mount (supplied by others).
- Field Mount.

Options and Accessories:

- Three flow sensors (hot, cold, and discharge) for DDC controls contractor flexibility.
- 24 VAC Control transformer.
- Toggle disconnect switch.
- Bottom access door (Model 0800-M1).
- Controls enclosure for field or factory mounted controls.
- Dust tight enclosure seal.
- Factory wrapped inlets and outlet.
- Removable flow sensors.
- Hanger brackets.



B

DUAL DUCT TERMINAL UNITS

Dimensions

Model 3230HQ • With Compact Mixing Attenuator • Hospital Grade • Dissipative Silencer

Digital Controls

- Variable or constant volume operation.
- Rectangular discharge silencer optimally sized for duct run out.
- Integral mixing attenuator construction reduces insulation seams and reduces casing leakage.
- Multi-point Diamond Flow Sensor available in three location configurations to suit exact control sequence requirement.
- Solid mixing baffles standard.
- Unique low leakage opposed blade dampers control each deck independently. 90° rotation. CW to close.
- Right hand and left hand are flippable.
- When unequal sized inlets are used, the casing will be governed by the larger inlet size.
- Choice of right or left hand cold deck location. Hand of unit is determined by location of cold deck looking in direction of airflow. Right hand unit illustrated.

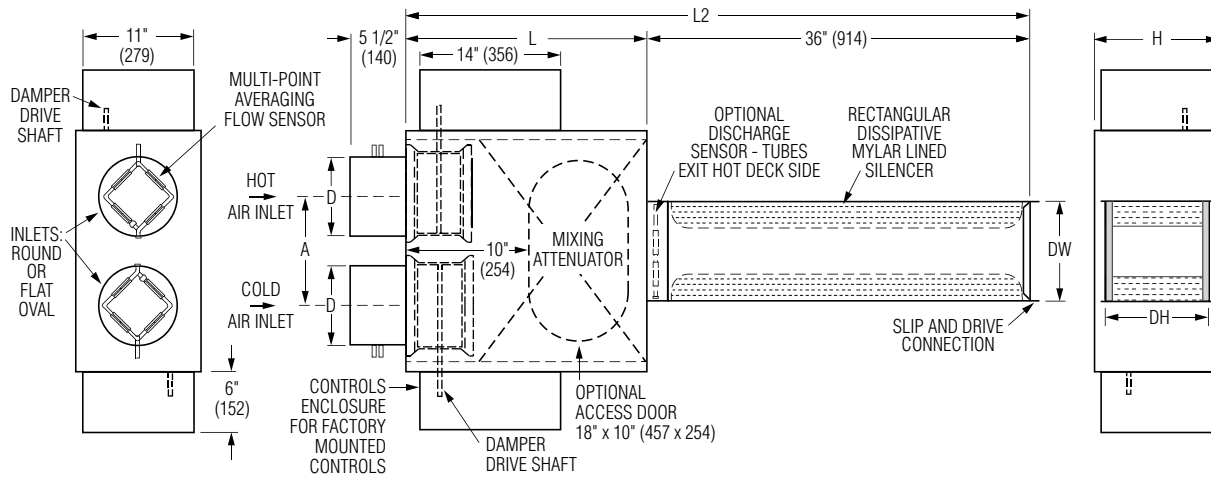

Dimensional Data

Unit Size	Total Airflow Range, CFM (l/s) Digital Controls	W	H	L	L2	A	Inlet Dia. D	Outlet DW x DH
4	0 – 225 (0 – 106)	24 (610)	10 (254)	24 (610)	60 (1524)	11 (279)	3 7/8 (98)	
5	0 – 400 (0 – 189)	24 (610)	10 (254)	24 (610)	60 (1524)	11 (279)	4 7/8 (124)	12 x 8 (305 x 203)
6	0 – 550 (0 – 260)	24 (610)	10 (254)	24 (610)	60 (1524)	11 (279)	5 7/8 (149)	
7	0 – 800 (0 – 378)	24 (610)	12 1/2 (318)	24 (610)	60 (1524)	11 (279)	6 7/8 (175)	14 x 10 (356 x 254)
8	0 – 1100 (0 – 519)	24 (610)	12 1/2 (318)	24 (610)	60 (1524)	11 (279)	7 7/8 (200)	
9	0 – 1400 (0 – 661)	34 (864)	14 (356)	34 (864)	70 (1778)	16 1/8 (410)	8 7/8 (225)	18 x 12 (457 x 305)
10	0 – 1840 (0 – 868)	34 (864)	14 (356)	34 (864)	70 (1778)	16 1/8 (410)	9 7/8 (251)	
12	0 – 2500 (0 – 1180)	34 (864)	16 (406)	34 (864)	70 (1778)	16 1/8 (410)	11 7/8 (302)	22 x 14 (559 x 356)
14	0 – 3370 (0 – 1590)	42 (1067)	18 (457)	38 (965)	71 (1880)	20 1/8 (511)	13 7/8 (353)	26 x 16 (660 x 406)
16	0 – 4525 (0 – 2135)	42 (1067)	18 (457)	38 (965)	71 (1880)	20 1/8 (511)	15 7/8 (403)	30 x 16 (762 x 406)

B

DUAL DUCT TERMINAL UNITS

Performance Data • NC Level Application Guide

Model 3230HQ • With Mixing Attenuator • Hospital Grade • Dissipative Silencer

Terminal: Steri-Liner • Silencer: Mylar, Spacer, Steri-Liner (MSSL) Media

Inlet Size	Airflow cfm /s		Min. inlet ΔPs "w.g. Pa		NC Levels @ Inlet Pressure (ΔPs) shown											
					DISCHARGE					RADIATED						
					Min. ΔPs	0.5" w.g. (125 Pa)	1.0" w.g. (250 Pa)	1.5" w.g. (375 Pa)	2.0" w.g. (500 Pa)	3.0" w.g. (750 Pa)	Min. ΔPs	0.5" w.g. (125 Pa)	1.0" w.g. (250 Pa)	1.5" w.g. (375 Pa)	2.0" w.g. (500 Pa)	3.0" w.g. (750 Pa)
4	200	94	0.51	125	-	*	-	22	21	25	-	*	-	-	-	21
	150	71	0.29	71	-	-	-	-	-	20	27	-	-	-	-	-
	100	47	0.13	32	-	-	-	-	-	-	-	-	-	-	-	20
	25	12	0.01	2	21	-	-	-	22	25	-	-	-	-	-	20
5	350	165	0.42	104	-	-	23	27	28	31	-	-	21	26	26	30
	250	118	0.22	55	-	-	-	22	24	28	-	-	-	-	20	23
	150	71	0.08	21	-	-	-	-	-	-	-	-	-	-	-	20
	50	24	0.01	2	-	-	-	-	-	-	-	-	-	-	-	-
6	550	260	0.67	165	-	*	25	31	33	37	21	*	27	31	33	36
	400	189	0.36	88	-	-	21	26	30	34	-	-	23	27	27	31
	250	118	0.14	35	-	-	-	23	26	30	-	-	-	20	22	24
	75	35	0.02	5	*	-	-	-	-	23	-	-	-	-	-	-
7	750	354	0.66	165	26	*	36	42	43	44	-	*	32	39	44	50
	550	260	0.41	100	-	26	32	33	39	44	-	-	28	34	39	45
	350	165	0.20	49	-	-	26	31	30	28	-	-	27	32	36	39
	100	47	0.03	7	-	-	-	-	-	-	-	-	20	20	21	23
8	950	448	0.87	217	37	*	39	43	47	51	25	*	34	42	46	52
	700	330	0.48	119	27	26	36	40	40	45	20	23	32	38	43	49
	450	212	0.20	50	-	-	24	29	31	30	22	-	30	34	38	43
	125	59	0.02	4	35	-	-	-	-	-	-	-	23	21	24	24
9	1200	566	0.43	107	25	30	38	43	47	53	21	34	34	39	44	49
	900	425	0.25	61	-	26	35	40	42	45	-	21	32	37	40	46
	600	283	0.11	28	-	23	29	31	31	27	-	-	25	28	32	34
	175	83	0.01	2	24	-	-	-	-	-	-	-	-	-	-	-
10	1600	755	0.58	145	33	*	35	42	45	53	30	*	37	43	46	51
	1100	519	0.28	71	-	20	33	41	42	47	-	23	33	38	42	47
	600	283	0.09	22	-	20	28	30	28	26	-	-	25	28	31	33
	225	106	0.01	3	27	-	-	-	-	-	-	-	-	-	-	-
12	2200	1038	0.87	215	44	*	38	44	48	52	32	*	34	40	44	51
	1600	755	0.46	114	38	29	36	42	44	48	21	23	31	37	40	46
	1000	472	0.18	44	-	-	27	32	32	31	-	-	27	31	34	39
	300	142	0.02	4	-	-	-	-	-	-	-	-	-	-	20	21
14	2900	1369	0.83	206	35	*	38	42	43	45	30	*	30	34	38	43
	2100	991	0.46	114	26	28	32	36	39	43	20	21	26	31	34	38
	1300	613	0.21	53	-	-	25	30	32	36	-	-	21	28	30	33
	400	189	0.08	20	-	-	25	30	33	36	-	-	-	20	-	25
16	4350	2053	1.61	400	52	*	*	*	51	53	43	*	*	*	42	47
	3550	1675	1.10	274	45	*	*	45	46	49	34	*	*	36	38	44
	2750	1298	0.70	172	33	*	36	39	42	45	25	*	28	33	36	42
	1950	920	0.39	96	-	24	31	35	38	43	-	-	25	28	31	36
1150	543	0.18	45	-	-	23	28	31	36	-	-	-	23	24	27	

Performance Notes:

1. NC Levels are calculated based on procedures as documented on page B31.
2. Dash (-) in space indicates a NC less than 20.
3. Asterisk (*) in space indicates that the minimum inlet static pressure requirement is greater than 0.5" w.g. (125 Pa) at rated airflow.

B
DUAL DUCT TERMINAL UNITS

Performance Data • Discharge Sound Power Levels

Model 3230HQ • With Mixing Attenuator

Hospital Grade • Dissipative Silencer

Terminal: Steri-Liner • Silencer: Mylar, Spacer, Steri-Liner (MSSL) Media

Inlet Size	Airflow		Min. inlet ΔPs		Sound Power Octave Bands @ Inlet Pressure (ΔPs) shown																																									
					Minimum ΔPs							0.5" w.g. (125Pa) ΔPs							1.0" w.g. (250Pa) ΔPs							1.5" w.g. (375Pa) ΔPs							2.0" w.g. (500Pa) ΔPs							3.0" w.g. (750Pa) ΔPs						
					"w.g.	Pa	2	3	4	5	6	7	2	3	4	5	6	7	2	3	4	5	6	7	2	3	4	5	6	7	2	3	4	5	6	7	2	3	4	5	6	7				
4	200	94	0.51	125	57	56	44	26	12	27	*	*	*	*	*	*	62	59	47	38	21	29	63	62	50	41	24	32	62	62	52	43	28	35	65	65	56	45	31	40						
	150	71	0.29	71	55	50	36	17	7	19	55	51	40	29	12	20	58	55	45	35	18	27	60	60	50	40	24	33	60	60	52	41	26	35	60	61	53	43	29	40						
	100	47	0.13	32	53	47	33	18	20	20	53	51	37	27	13	16	55	53	42	33	16	25	55	53	46	34	21	31	57	55	47	36	24	34	54	54	48	37	25	37						
	25	12	0.01	2	60	62	20	20	20	20	54	50	44	33	23	25	55	42	31	23	16	35	63	48	33	16	14	33	65	51	34	13	14	31	68	53	38	11	11	27						
5	350	165	0.42	104	67	62	43	26	15	29	66	61	44	35	21	29	68	65	47	38	27	33	70	68	50	42	31	36	71	69	52	44	34	39	73	71	56	47	36	44						
	250	118	0.22	55	59	53	35	21	9	18	58	56	37	28	14	19	63	59	43	35	21	29	66	63	48	39	26	35	65	64	49	39	27	36	68	68	54	43	29	40						
	150	71	0.08	21	56	46	19	13	20	20	55	52	35	25	16	19	57	55	39	33	18	28	59	55	44	33	23	34	60	58	46	31	22	35	62	59	47	35	22	37						
	50	24	0.01	2	59	57	20	20	20	20	52	50	47	29	23	24	54	47	52	46	33	42	56	43	44	37	31	41	57	47	42	29	26	40	58	50	42	22	17	38						
6	550	260	0.67	165	66	60	47	34	32	33	*	*	*	*	*	*	70	66	54	45	39	39	73	71	57	49	42	42	75	73	59	50	42	44	77	76	62	52	45	48						
	400	189	0.36	88	60	52	40	25	21	23	63	58	46	36	27	26	68	63	51	42	32	31	71	67	54	46	35	36	72	70	56	47	36	39	73	74	59	49	39	43						
	250	118	0.14	35	59	46	31	15	19	18	58	54	41	32	19	23	62	59	46	37	24	31	64	63	49	39	27	34	65	66	52	39	28	38	69	69	55	42	31	42						
	75	35	0.02	5	39	25	20	20	20	20	50	43	28	24	15	23	51	52	36	23	9	22	57	55	38	22	18	26	57	60	42	26	22	31	61	63	46	29	24	35						
7	750	354	0.66	165	70	68	51	40	37	39	*	*	*	*	*	*	76	76	62	47	43	45	81	81	66	52	48	53	81	82	67	54	48	55	82	83	70	57	50	58						
	550	260	0.41	100	66	59	45	32	26	29	69	67	52	37	29	30	75	72	59	45	36	41	76	73	62	49	40	46	77	78	65	50	40	48	77	82	68	53	41	51						
	350	165	0.20	49	54	45	30	18	18	16	63	60	49	34	21	26	66	67	55	39	26	35	67	71	58	42	29	41	67	70	58	42	28	43	66	69	58	41	27	43						
	100	47	0.03	7	58	52	24	20	20	20	52	51	38	22	23	24	50	51	40	25	21	39	51	51	38	24	25	37	53	55	38	25	24	40	54	56	39	24	22	45						
8	950	448	0.87	217	78	77	57	45	38	40	*	*	*	*	*	*	80	79	59	45	39	45	84	82	65	48	42	49	84	86	67	50	41	51	88	89	70	54	44	55						
	700	330	0.48	119	72	68	49	36	25	30	71	67	49	35	28	33	78	75	58	41	32	39	81	79	62	45	36	46	83	79	64	47	35	47	84	83	67	49	36	51						
	450	212	0.20	50	55	50	36	23	24	24	62	61	47	31	19	27	65	65	54	36	23	36	69	69	58	40	26	41	68	71	59	42	27	44	67	70	60	44	28	46						
	125	59	0.02	4	76	62	26	20	20	20	59	55	42	20	15	19	54	52	43	25	19	30	52	49	42	26	18	37	56	52	39	25	16	37	59	57	40	25	14	39						
9	1200	566	0.43	107	73	67	49	37	35	38	73	71	52	37	39	42	80	78	58	42	43	49	85	82	61	46	46	54	87	86	64	47	47	55	90	91	68	50	47	58						
	900	425	0.25	61	64	55	39	28	22	24	70	68	49	33	31	33	78	76	55	39	36	42	83	80	60	41	39	48	83	81	60	43	38	48	84	84	63	44	39	50						
	600	283	0.11	28	56	43	28	14	7	10	67	64	44	28	22	28	73	70	50	33	27	36	74	71	51	34	28	39	71	71	51	35	28	40	69	68	50	35	27	43						
	175	83	0.01	2	67	59	26	20	20	20	57	51	29	17	15	21	50	46	32	20	19	29	49	42	33	22	20	34	49	43	29	21	18	39	53	50	30	20	19	44						
10	1600	755	0.58	145	79	70	53	43	45	48	*	*	*	*	*	*	81	74	56	43	48	53	86	80	62	46	50	58	89	84	65	47	52	59	94	91	69	52	54	63						
	1100	519	0.28	71	66	54	39	33	29	29	67	63	45	33	34	33	78	74	54	38	40	43	85	79	60	42	44	51	86	81	62	44	44	51	88	86	66	46	46	53						
	600	283	0.09	22	57	44	28	15	19	20	67	62	43	27	22	28	73	69	49	30	27	35	75	70	51	31	27	38	74	69	51	30	28	40	71	67	49	32	29	43						
	225	106	0.01	3	70	58	20	20	20	20	60	53	31	17	19	24	55	50	36	25	23	35	52	48	39	22	23	40	52	46	36	22	23	41	52	47	35	22	26	45						
12	2200	1038	0.87	215	88	78	56	47	51	51	*	*	*	*	*	*	84	76	57	43	51	54	88	80	60	46	52	57	91	84	63	46	54	59	94	88	67	50	58	63						
	1600	755	0.46	114	83	69	48	40	41	40	76	66	48	37	43	42	82	73	53	39	46	47	86	80	57	42	50	53	88	82	60	44	51	54	90	86	65	47	54	59						
	1000	472	0.18	44	60	52	39	28	30	26	65	60	42	30	30	30	72	69	50	35	37	39	76	73	54	36	40	44	77	73	54	37	42	45	75	72	55	38	44	47						
	300	142	0.02	4	55	45	20	20	20	17	56	46	23	5	8	12	56	47	29	18	18	22	57	49	35	18	26	31	58	49	36	20	29	35	61	53	39	24	34	42						
14	2900	1369	0.83	206	81	70	58	48	51	50	*	*	*	*	*	*	83	74	60	49	54	56	86	77	62	51	55	59	87	79	63	51	54	59	89	82	66	54	56	62						
	2100	991	0.46	114	74	62	50	41	42	39	75	64	51	41	45	45	79	69	54	42	48	48	82	74	57	44	50	52	84	76	59	46	50	54	87	78	63	49	53	58						
	1300	613	0.21	53	62	49	38	28	24	21	68	58	43	32	34	33	73	64	48	36	40	41	77	69	53	39	44	47	79	71	56	41	46	49	82	75	60	45	50	54						
	400	189	0.08	20	54	40	30	23	20	20	62	55	40	29	29	31	71	64	46	34	34	39	75	69	50	36	37	42	77	71	53	38	39	43	80	75	58	38	41	47						
16	4350	2053	1.61	400	94	86	66	59	63	63	*	*	*	*	*	*	*	*	*	*	*	*	*	*	*	*	*	*	93	87	71	59	63	68	95	88	73	60	65	69						
	3550	1675	1.10	274	89	79	60	52	56	57	*	*	*	*	*	*	*	*	*	*	*	*	*	*	*	*	*	*	88	81	67	55	60	63	89	84	67	55	59	62	91	86	70	57	61	65
	2750	1298	0.70	172	79	70	52	46	48	48	*	*	*	*	*	*	82	73	59	48	52	54	84	77	63	50	54	58	87	81	63	50	55	59	89	83	66	53	58	62						
	1950	920	0.39																																											

Performance Data • Radiated Sound Power Levels

Model 3230HQ • With Mixing Attenuator

Hospital Grade • Dissipative Silencer

Terminal: Steri-Liner • Silencer: Mylar, Spacer, Steri-Liner (MSSL) Media

B
DUAL DUCT TERMINAL UNITS

Inlet Size	Airflow		Min. inlet ΔPs		Sound Power Octave Bands @ Inlet Pressure (ΔPs) shown																																			
					Minimum ΔPs					0.5" w.g. (125Pa) ΔPs					1.0" w.g. (250Pa) ΔPs					1.5" w.g. (375Pa) ΔPs					2.0" w.g. (500Pa) ΔPs					3.0" w.g. (750Pa) ΔPs										
					2	3	4	5	6	7	2	3	4	5	6	7	2	3	4	5	6	7	2	3	4	5	6	7	2	3	4	5	6	7	2	3	4	5	6	7
4	200	94	0.51	125	-	34	32	26	28	-	*	*	*	*	*	*	53	47	39	31	29	27	53	49	41	32	32	33	55	51	43	34	34	35	56	53	46	38	36	37
	150	71	0.29	71	-	32	29	23	57	-	47	40	32	25	24	-	51	45	36	28	25	24	51	47	38	29	28	30	53	29	42	31	30	32	54	51	45	37	32	34
	100	47	0.13	32	-	-	27	24	23	-	45	38	29	22	-	-	47	41	33	24	24	25	48	45	37	26	25	33	47	44	42	30	25	30	48	47	46	39	30	34
	25	12	0.01	2	-	-	-	-	-	-	37	30	17	-	-	-	35	29	-	-	-	-	38	37	29	14	11	33	31	29	40	-	-	-	32	35	46	41	-	28
5	350	165	0.42	104	25	46	43	36	29	-	64	46	39	39	37	-	69	51	44	37	39	35	71	55	46	37	37	35	72	56	48	38	38	37	74	59	52	43	40	39
	250	118	0.22	55	-	35	34	28	30	-	50	43	37	30	30	-	54	48	41	33	31	28	54	50	43	34	34	34	56	52	45	36	36	36	57	54	48	40	38	38
	150	71	0.08	21	-	-	23	-	-	-	36	40	36	21	-	-	38	45	39	29	21	-	39	47	42	32	30	32	39	48	44	34	32	33	40	50	46	38	34	37
	50	24	0.01	2	-	-	-	-	-	-	-	33	31	-	-	-	-	38	32	-	-	-	-	37	36	26	-	28	-	37	37	29	23	28	-	38	38	32	27	33
6	550	260	0.67	165	48	52	51	43	42	28	*	*	*	*	*	*	73	56	50	43	45	40	76	61	52	43	42	39	77	62	54	44	43	40	78	65	57	47	46	44
	400	189	0.36	88	49	43	39	34	32	28	56	49	45	37	32	27	59	54	48	39	36	32	62	58	51	42	40	36	62	58	51	41	41	39	64	61	53	44	43	43
	250	118	0.14	35	-	24	29	25	25	-	41	44	38	27	24	-	44	49	44	34	27	24	45	52	46	37	35	35	45	52	48	39	37	36	46	54	50	42	39	40
	75	35	0.02	5	-	-	-	-	-	-	-	33	23	-	-	-	-	38	34	20	-	-	-	38	37	28	23	29	-	38	38	30	26	30	-	38	39	34	30	34
7	750	354	0.66	165	53	48	44	33	27	-	*	*	*	*	*	*	66	62	51	41	36	32	70	68	58	45	42	37	72	72	62	50	46	41	76	77	66	53	50	46
	550	260	0.41	100	54	49	39	33	27	-	53	51	40	34	29	25	63	59	47	38	33	29	67	64	54	42	39	35	69	68	58	46	43	38	73	73	62	49	47	43
	350	165	0.20	49	26	24	24	-	-	-	53	50	40	30	-	-	61	58	47	36	32	29	63	62	52	39	36	33	65	65	55	42	39	35	67	68	58	45	43	40
	100	47	0.03	7	-	-	-	-	-	-	48	45	35	-	-	-	53	52	42	28	26	24	51	52	42	28	26	25	52	53	43	30	28	26	53	54	45	32	31	30
8	950	448	0.87	217	62	51	44	33	41	32	*	*	*	*	*	*	68	64	52	43	39	35	72	70	59	48	44	39	75	74	63	52	48	43	79	79	68	56	53	49
	700	330	0.48	119	57	52	42	36	30	-	56	54	43	37	32	28	66	62	50	41	36	32	70	67	57	45	42	38	72	71	61	49	46	41	76	76	65	52	50	46
	450	212	0.20	50	29	28	-	-	-	55	52	41	32	25	-	-	62	60	50	38	34	30	65	64	53	41	38	34	67	67	57	44	41	37	69	71	60	48	45	42
	125	59	0.02	4	-	-	-	-	-	48	46	36	-	-	-	-	54	54	45	29	27	23	52	53	44	30	28	26	53	55	46	32	30	27	53	55	46	33	32	30
9	1200	566	0.43	107	59	53	45	42	48	36	69	54	45	42	32	26	67	64	52	46	39	34	72	68	56	49	42	37	75	72	60	52	45	40	76	76	62	55	48	45
	900	425	0.25	61	54	48	41	38	32	24	57	53	43	41	35	29	65	62	50	45	39	34	69	66	54	47	42	37	72	69	57	50	45	40	74	74	61	54	48	45
	600	283	0.11	28	43	38	32	29	-	-	45	49	39	35	-	-	59	56	45	39	34	30	62	59	48	42	36	33	64	62	51	45	40	36	64	64	53	47	42	40
	175	83	0.01	2	-	-	-	-	-	-	-	40	28	22	-	-	44	42	31	27	23	23	43	44	34	29	26	25	44	45	36	33	30	29	44	44	38	33	32	31
10	1600	755	0.58	145	65	60	52	49	56	46	*	*	*	*	*	*	70	66	55	49	43	37	74	71	59	52	47	40	78	74	62	55	48	43	80	78	66	58	51	47
	1100	519	0.28	71	55	49	42	39	33	25	58	54	44	42	36	30	66	63	51	46	40	35	70	67	55	48	43	38	73	70	58	51	46	41	75	75	62	55	49	46
	600	283	0.09	22	37	32	26	23	-	-	39	48	38	34	-	-	58	56	44	39	34	31	61	59	48	42	37	33	62	61	50	45	40	37	63	63	53	47	42	40
	225	106	0.01	3	-	-	-	-	-	-	-	41	29	23	-	-	46	45	34	29	25	24	47	47	37	31	27	26	47	48	38	35	32	30	47	48	40	36	34	33
12	2200	1038	0.87	215	67	62	54	53	50	54	*	*	*	*	*	*	68	64	53	51	48	41	73	69	57	52	49	44	76	72	60	53	50	46	80	78	64	55	52	50
	1600	755	0.46	114	58	53	47	46	41	33	59	54	47	46	41	33	65	61	50	48	44	37	71	66	54	49	46	42	73	69	57	50	47	44	76	74	61	53	49	48
	1000	472	0.18	44	45	42	37	34	26	-	47	50	41	38	30	-	62	58	47	42	38	35	65	61	50	44	40	38	67	64	52	46	42	41	69	68	55	50	45	45
	300	142	0.02	4	-	-	-	-	-	-	-	39	26	-	-	-	51	49	37	29	24	26	52	50	39	32	27	29	52	52	40	35	29	32	53	53	42	42	35	37
14	2900	1369	0.83	206	66	58	50	42	37	41	*	*	*	*	*	*	66	60	51	41	38	36	69	63	56	45	43	40	72	66	59	48	46	44	73	71	63	51	50	49
	2100	991	0.46	114	58	49	42	36	31	28	59	50	43	36	31	29	63	57	49	39	36	34	66	61	54	43	41	39	68	64	57	45	44	42	70	67	60	49	47	46
	1300	613	0.21	53	46	35	30	25	24	-	-	47	40	31	24	22	59	53	47	37	35	33	62	59	51	40	38	38	61	60	53	41	40	39	68	60	56	47	43	42
	400	189	0.08	20	-	-	-	-	-	-	-	40	33	-	-	-	48	44	40	30	30	28	51	52	44	33	31	36	46	51	44	32	31	32	62	45	47	40	34	33
16	4350	2053	1.61	400	73	71	63	56	52	46	*	*	*	*	*	*	*	*	*	*	*	*	*	*	*	*	*	*	74	70	57	53	50	46	77	75	62	56	53	50
	3550	1675	1.10	274	68	64	56	50	46	40	*	*	*	*	*	*	*	*	*	*	*	*	70	65	53	49	46	42	72	67	56	51	48	45	75	72	61	54	51	49
	2750	1298	0.70	172	62	56	47	43	40	36	*	*	*	*	*	*	64	58	48	43	42	38	68	62	51	46	43	40	70	65	54	49	45	42	73	70	58	52	49	46
	1950	920	0.39	96	54	44	37	33	30	23	56	47	39	43	36	29	61	56	46	40	38	35	64	59	49	43	41	40	66	61	52	46	43	42	69	65	55	49	46	46
1150	543																																							

Performance Data • AHRI Certification and Performance Notes

Model 3230HQ • With Mixing Attenuator • Hospital Grade • Dissipative Silencer

AHRI Certification Points

Terminal: Steri-Liner • Silencer: Mylar, Spacer, Steri-Liner (MSSL) Media

Inlet Size	Airflow		Min. Inlet ΔPs		Discharge Sound Power Levels @ 1.5" w.g. (375 Pa) ΔPs						Radiated Sound Power Levels @ 1.5" w.g. (375 Pa) ΔPs					
					Octave Band						Octave Band					
	cfm	l/s	"w.g.	Pa	2	3	4	5	6	7	2	3	4	5	6	7
4	150	71	0.29	71	60	60	50	40	24	33	51	47	38	29	28	30
5	250	118	0.22	55	66	63	48	39	26	35	54	50	43	34	34	34
6	400	189	0.36	88	71	67	54	46	35	36	62	58	51	42	40	36
7	550	260	0.41	100	76	73	62	49	40	46	67	64	54	42	39	35
8	700	330	0.48	119	81	79	62	45	36	46	70	67	57	45	42	38
9	900	425	0.25	61	83	80	60	41	39	48	69	66	54	47	42	37
10	1100	519	0.28	71	85	79	60	42	44	51	70	67	55	48	43	38
12	1600	755	0.46	114	86	80	57	42	50	53	71	66	54	49	46	42
14	2100	991	0.46	114	82	74	57	44	50	52	66	61	54	43	41	39
16	2750	1298	0.70	172	84	77	63	50	54	58	68	62	51	46	43	40

Performance Notes for Sound Power Levels:

- Discharge sound power is the noise emitted from the unit discharge into the downstream duct. Discharge Sound Power Levels (SWL) now include duct end reflection energy as part of the standard rating. Including the duct end correction provides sound power levels that would normally be transmitted into an acoustically, non-reflective duct. The effect of including the energy correction to the discharge SWL, is higher sound power levels when compared to previous AHRI certified data. For more information on duct end reflection calculations see AHRI Standard 880.
- Radiated sound power is the breakout noise transmitted through the unit casing walls.
- Sound power levels are in decibels, dB re 10⁻¹² watts.
- All sound data listed by octave bands is raw data without any corrections for room absorption or duct attenuation. Dash (-) in space indicates sound power level is less than 20 dB or equal to background.
- Minimum inlet ΔPs is the minimum operating pressure requirement of the unit (damper full open) and the difference in static pressure from inlet to discharge of the unit.
- Asterisk (*) in space indicates that the minimum inlet static pressure requirement is greater than 0.5" w.g. (125 Pa) at rated airflow.
- Data derived from independent tests conducted in accordance with ANSI/ASHRAE Standard 130 and AHRI Standard 880.

DUAL DUCT VARIABLE OR CONSTANT AIR VOLUME

3200 SERIES

- "BLENDMASTER™"
- 1 : 30 MIXING
- INDUSTRY LEADING PERFORMANCE

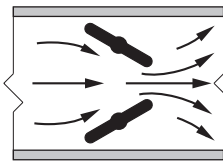

Opposed blade damper configuration minimizes noisy turbulence and provides smooth, accurate, near linear flow control.

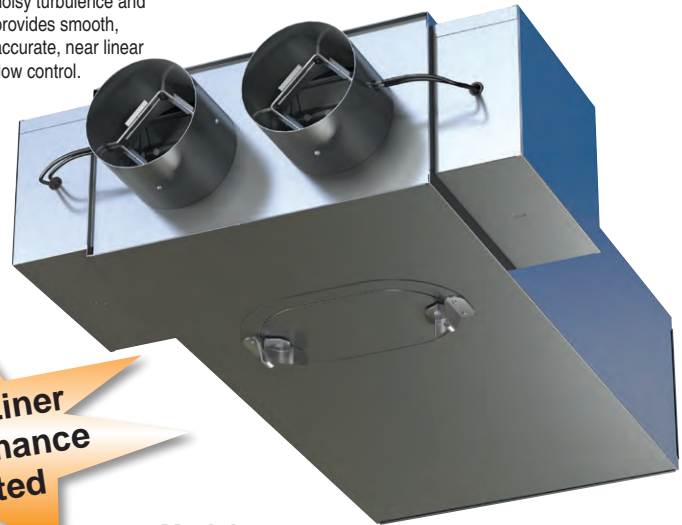

Model 3240



Model:

3240 With High Efficiency Mixing Attenuator

The model 3240 "BlendMaster™" is a dual duct terminal unit offering superior performance for the most demanding applications. Maintaining zone pressurization have regenerated interest in the benefits of a dual duct system design. Applications include hospitals, research laboratories, schools and other institutional facilities where both overhead heating and cooling are required and a dual duct design has been deemed the preferred system.

Equipped with specially designed extra low leakage, opposed blade dampers, the "BlendMaster™" provides accurate airflow control of the hot and cold decks with tight shut-off. An extended integral mixer attenuator section provides superior blending of the hot and cold airflow during mixing at reduced minimum operating pressures compared to other manufacturers designs thus ensuring uniform flow and temperature equalization downstream. Minimum mixing efficiency is an unprecedented 1:30; less than 1°F (0.55°C) temperature variation at the discharge for each 30°F (16.67°C) temperature difference between the hot and cold decks.

Dual duct terminals are frequently specified with fiber free insulation option. For this reason, the sound data presented for this terminal unit uses the **Steri-Liner** option, rather than standard fiberglass insulation, thus permitting a more accurate selection than is possible with other manufacturers equipment.

STANDARD FEATURES:

- 22 ga. (0.86) zinc coated steel casing, mechanically sealed, low leakage construction.
- Low leakage opposed blade damper designed with blade and jamb seals (single blade on size 4, 5, 6). Damper leakage is less than 1% of nominal flow at 6" w.g. (1.5 kPa). 90° rotation, CW to close.
- 1/2" (13) dia. plated steel driveshaft. An indicator mark on the end of the shaft shows damper position.
- Integral mixing attenuator with baffles. 1:30 minimum mixing efficiency.
- Designed for digital, analog electronic or pneumatic pressure independent control.
- Multi-point averaging Diamond Flow Sensors standard for all applications; ensure accurate flow control.

- Gauge taps provided for field calibration and balancing.
- Downstream total flow sensing available for maximum control accuracy.
- Available in nine unit sizes to handle from 180 – 3370 cfm (85 – 1590 l/s).
- Unequal inlet sizes are available. Casing is governed by the larger inlet.
- 3/4" (19), dual density insulation, exposed edges coated to prevent air erosion. Meets the requirements of NFPA 90A and UL 181.
- Full NEMA 1 type controls enclosure for factory mounted controls.

Controls:

- Digital (supplied by others).
- Analog (by Nailor).

Options:

- Available with a bottom access door (Model 0820-1).
- Other IAQ insulations are available.
- Low leakage casing.
- Steri-liner.
- Fiber-free liner.
- Perforated metal liner.
- Solid metal liner.
- 1" (25) liner.
- Seismic Certification.



Intertek



Dimensions

Model 3240 "BlendMaster™" • Mixing Applications

- Variable or constant volume operation.
- Rectangular discharge optimally sized for duct run out.
- Integral mixing attenuator construction reduces insulation seams and reduces casing leakage.
- Multi-point Diamond Flow Sensor available in three location configurations to suit exact control sequence requirement.
- Double set of solid mixing baffles are standard.
- Unique low leakage opposed blade dampers control each deck independently. 90° rotation. CW to close.
- Right hand and left hand are flippable.
- When unequal sized inlets are used, the casing will be governed by the larger inlet size.
- Choice of right or left hand cold deck location. Hand of unit is determined by location of cold deck looking in direction of airflow. Right hand unit illustrated.

Pneumatic Controls

- Universal pneumatic control mounting panel features double wall stand-off construction for strength and rigidity. Controls mounting screws do not penetrate casing.

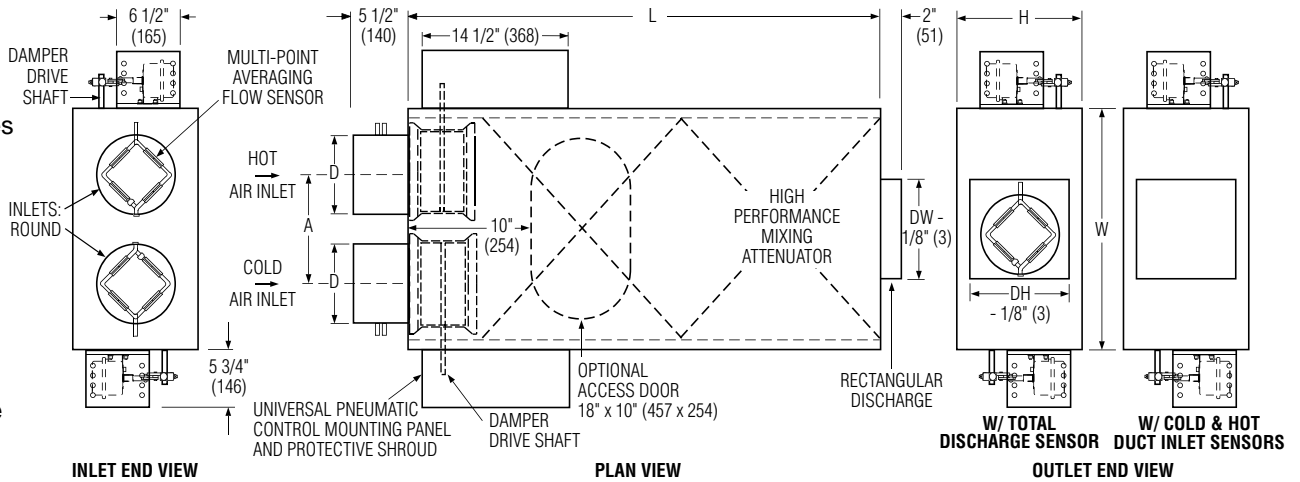

Analog Electronic and Digital Controls

- A full NEMA 1 controls enclosure is provided for factory mounted controls. Optional for field mounted controls.

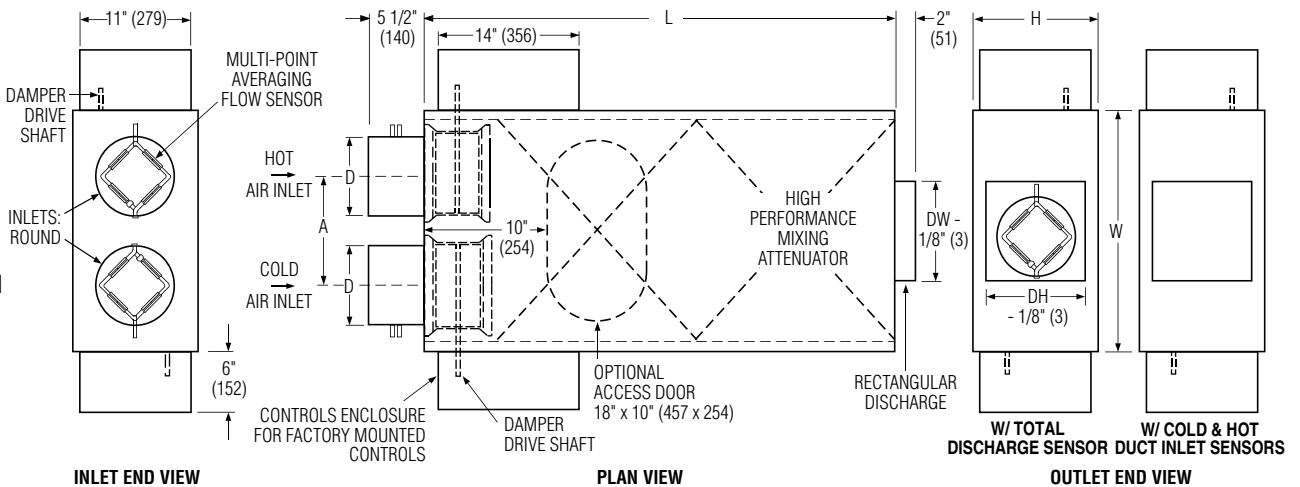

Dimensional Data

Unit Size	W	H	L	A	Inlet Dia. D	Outlet DW x DH
4	24 (610)	10 (254)	47 (1194)	11 (279)	3 7/8 (98)	
5	24 (610)	10 (254)	47 (1194)	11 (279)	4 7/8 (124)	8 x 8 (203 x 203)
6	24 (610)	10 (254)	47 (1194)	11 (279)	5 7/8 (149)	
7	24 (610)	12 1/2 (318)	47 (1194)	11 (279)	6 7/8 (175)	10 x 10 (254 x 254)
8	24 (610)	12 1/2 (318)	47 (1194)	11 (279)	7 7/8 (200)	
9	34 (864)	14 (356)	60 (1524)	16 1/8 (410)	8 7/8 (225)	14 x 12 (356 x 305)
10	34 (864)	14 (356)	60 (1524)	16 1/8 (410)	9 7/8 (251)	
12	34 (864)	16 (406)	60 (1524)	16 1/8 (410)	11 7/8 (302)	18 x 14 (457 x 356)
14	42 (1067)	18 (457)	72 (1829)	20 1/8 (511)	13 7/8 (353)	22 x 16 (559 x 406)

Recommended Airflow Ranges For Model 3240 Dual Duct Pressure Independent Terminal Units

The recommended airflow ranges below are for dual duct terminal units with pressure independent controls and are presented as ranges for total and controller specific minimum and maximum airflow. Airflow ranges are based upon maintaining reasonable sound levels and controller limits using Nailor's Diamond Flow Sensor as the airflow measuring device. For a given unit size, the minimum, auxiliary minimum (where applicable) and the maximum flow setting must be within the range limits to ensure pressure independent operation, accuracy and repeatability.

Minimum airflow limits are based upon .02" w.g. (5 Pa) differential pressure signal from Diamond Flow Sensor on analog/digital controls and .03" (7.5) for pneumatic controllers. This is a realistic low limit for many transducers used in the digital controls industry. Check your controls supplier for minimum limits. Setting airflow minimums lower, may cause hunting and failure to meet minimum ventilation requirements. Where an auxiliary setting is specified, the value must be greater than the minimum setting.

The high end of the tabulated Total Airflow Range on pneumatic and analog electronic controls represents the Diamond Flow Sensor's differential pressure reading at 1" w.g. (250 Pa). The high end airflow range for digital controls is represented by the indicated transducer differential pressure. ASHRAE 130 "Performance Rating of Air Terminals" is the

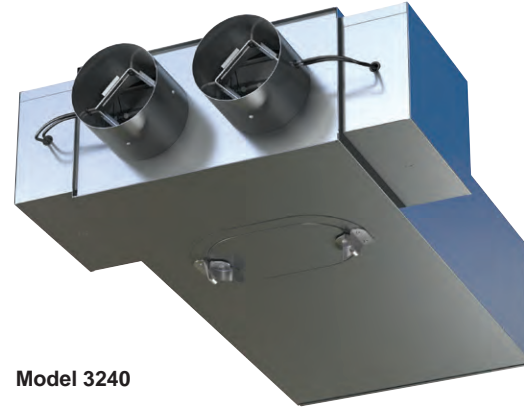

Model 3240

method of test for the certification program. The "standard rating condition" (certification rating point) airflow volumes for each terminal unit size are tabulated below per AHRI Standard 880. These air volumes equate to an approximate inlet velocity of 2000 fpm (10.2 m/s).

When digital or other controls are mounted by Nailor, but supplied by others, these values are guidelines only, based upon experience with the majority of controls currently available. Controls supplied by others for factory mounting are configured and calibrated in the field. Airflow settings on pneumatic and analog controls supplied by Nailor are factory preset when provided.

Imperial Units, Cubic Feet per Minute

Unit Size	Inlet Type	Total Airflow Range, cfm	Airflow at 2000 fpm Inlet Velocity (nom.), cfm	Range of Minimum and Maximum Settings, cfm							
				Pneumatic 3000 Controller		Analog Electronic Controls		Digital Controls			
				Transducer Differential Pressure ("w.g.)							
				Min.	Max.	Min.	Max.	Min.	Max.		
.03	1.0	.02	1.0	.02	1.0	1.25	1.5				
4	Round	0 – 225	150	30	180	25	180	25	180	200	225
5		0 – 400	250	55	325	45	325	45	325	360	400
6		0 – 550	400	80	450	65	450	65	450	500	550
7		0 – 800	550	115	650	95	650	95	650	725	800
8		0 – 1100	700	155	900	125	900	125	900	1000	1100
9		0 – 1400	900	200	1150	165	1150	165	1150	1285	1400
10		0 – 1840	1100	260	1500	215	1500	215	1500	1675	1840
12		0 – 2500	1600	350	2050	290	2050	290	2050	2290	2500
14		0 – 3370	2100	475	2740	390	2740	390	2740	3075	3370

Metric Units, Liters per Second

Unit Size	Inlet Type	Total Airflow Range, l/s	Airflow at 10.2 m/s Inlet Velocity (nom.), l/s	Range of Minimum and Maximum Settings, l/s							
				Pneumatic 3000 Controller		Analog Electronic Controls		Digital Controls			
				Transducer Differential Pressure (Pa)							
				Min.	Max.	Min.	Max.	Min.	Max.		
7.5	249	5	249	5	249	311	374				
4	Round	0 – 106	71	14	85	12	85	12	85	94	106
5		0 – 189	118	26	153	21	153	21	153	170	189
6		0 – 260	189	38	212	31	212	31	212	236	260
7		0 – 378	260	54	307	45	307	45	307	342	378
8		0 – 519	330	73	425	59	425	59	425	472	519
9		0 – 661	425	94	543	78	543	78	543	606	661
10		0 – 868	519	123	708	101	708	101	708	790	868
12		0 – 1180	755	165	967	137	967	137	967	1081	1080
14		0 – 1590	991	224	1298	184	1298	184	1298	1451	1590

B DUAL DUCT TERMINAL UNITS

Performance Data • NC Level Application Guide Model 3240 "BlendMaster™" • With Mixing Attenuator Steri-Liner

Inlet Size	Airflow cfm l/s		Min. inlet ΔPs "w.g. Pa		NC Levels @ Inlet Pressure (ΔPs) shown											
					DISCHARGE					RADIATED						
					Min. ΔPs	0.5" w.g. (125 Pa)	1.0" w.g. (250 Pa)	1.5" w.g. (375 Pa)	2.0" w.g. (500 Pa)	3.0" w.g. (750 Pa)	Min. ΔPs	0.5" w.g. (125 Pa)	1.0" w.g. (250 Pa)	1.5" w.g. (375 Pa)	2.0" w.g. (500 Pa)	3.0" w.g. (750 Pa)
4	200	94	0.49	123	-	-	24	26	28	29	-	-	-	-	-	-
	150	71	0.29	72	-	-	20	24	23	21	-	-	-	-	-	-
	100	47	0.14	34	-	-	-	-	-	-	-	-	-	-	-	-
	25	12	0.01	2	-	-	-	-	-	-	-	-	-	-	-	-
5	350	165	0.43	106	-	20	26	31	31	34	-	-	-	20	24	26
	250	118	0.21	51	-	20	24	28	29	31	-	-	-	-	-	20
	150	71	0.07	17	-	-	-	21	20	21	-	-	-	-	-	-
	50	24	0.01	2	-	-	-	-	-	-	-	-	-	-	-	-
6	550	260	0.66	165	26	*	29	33	33	38	-	*	21	26	29	33
	400	189	0.37	91	-	-	24	29	30	33	-	-	-	21	25	29
	250	118	0.15	38	-	-	23	25	25	28	-	-	-	-	-	21
	75	35	0.02	4	-	-	-	-	-	-	-	-	-	-	-	-
7	800	378	0.91	226	-	*	35	40	44	49	23	*	30	35	38	43
	750	354	0.81	200	-	*	33	37	40	46	20	*	29	35	37	41
	550	260	0.45	111	-	21	33	37	40	44	-	-	23	29	34	38
	100	47	0.02	4	-	-	-	-	-	-	-	-	-	-	-	-
8	950	448	0.97	241	31	*	31	37	40	45	23	*	31	38	41	46
	700	330	0.54	134	23	*	30	37	39	45	-	*	26	33	37	41
	450	212	0.23	57	-	-	29	35	35	36	-	-	21	26	28	31
	125	59	0.02	4	-	-	-	-	-	-	-	-	-	-	-	-
9	1200	566	0.54	134	25	*	31	38	41	45	-	*	29	35	38	41
	900	425	0.31	77	-	20	28	35	38	40	-	-	25	33	36	40
	600	283	0.14	35	-	21	28	30	31	33	-	-	20	25	28	31
	175	83	0.01	2	-	-	-	-	-	-	-	-	-	-	-	-
10	1600	755	0.77	191	30	*	31	39	43	48	28	*	31	37	40	45
	1100	519	0.37	93	20	21	30	38	39	44	-	-	26	34	37	41
	600	283	0.12	29	-	-	28	31	30	33	-	-	20	24	28	30
	225	106	0.02	4	-	-	-	-	-	-	-	-	-	-	-	-
12	2200	1038	1.09	271	35	*	-	39	43	46	34	*	-	41	46	50
	1600	755	0.58	144	25	*	31	36	39	43	21	*	31	38	41	46
	1000	472	0.23	58	-	-	28	33	34	37	-	-	25	29	33	36
	300	142	0.02	4	-	-	-	-	-	-	-	-	-	-	-	21
14	2900	1369	0.91	226	34	*	35	39	40	44	33	*	36	41	45	50
	2100	991	0.49	121	25	25	30	34	36	39	21	21	31	38	41	46
	1300	613	0.19	48	-	-	25	29	31	35	-	-	24	29	31	35
	400	189	0.02	4	-	-	-	-	-	-	-	-	-	-	-	-

Performance Notes:

1. NC Levels are calculated based on procedures as documented on page B31.
2. Dash (-) in space indicates a NC less than 20.
3. Asterisk (*) in space indicates that the minimum inlet static pressure requirement is greater than 0.5" w.g. (125 Pa) at rated airflow.

Performance Data • Discharge Sound Power Levels

Model 3240 • With Mixing Attenuator • "BlendMaster™"

Steri-Liner



B
DUAL DUCT TERMINAL UNITS

Inlet Size	Airflow		Min. inlet ΔPs		Sound Power Octave Bands @ Inlet Pressure (ΔPs) shown																																									
					Minimum ΔPs							0.5" w.g. (125Pa) ΔPs							1.0" w.g. (250Pa) ΔPs							1.5" w.g. (375Pa) ΔPs							2.0" w.g. (500Pa) ΔPs							3.0" w.g. (750Pa) ΔPs						
					2	3	4	5	6	7	2	3	4	5	6	7	2	3	4	5	6	7	2	3	4	5	6	7	2	3	4	5	6	7	2	3	4	5	6	7						
4	200	94	0.49	123	61	56	41	29	27	32	61	57	42	30	27	32	67	61	48	38	32	34	68	66	52	42	38	38	68	67	54	44	41	40	69	68	58	47	45	45						
	150	71	0.29	72	58	51	35	23	21	25	60	54	39	28	23	26	64	60	45	36	31	32	65	64	51	41	38	37	64	63	53	42	40	39	65	62	55	45	43	43						
	100	47	0.14	34	59	44	27	-	-	-	58	52	37	27	22	23	58	57	43	33	30	30	60	58	49	38	35	36	59	56	49	38	36	37	60	57	50	41	39	41						
	25	12	0.01	2	55	40	-	-	-	-	58	43	26	-	-	-	57	43	31	-	-	23	57	44	35	24	23	26	60	46	36	24	23	26	58	45	37	24	24	30						
5	350	165	0.43	106	65	60	45	33	28	31	66	62	46	34	29	32	68	67	52	39	33	34	73	71	56	43	39	39	73	71	56	45	41	41	75	73	59	47	45	45						
	250	118	0.21	51	60	53	36	24	-	22	61	61	43	29	24	25	65	64	47	36	31	32	68	67	51	40	36	37	69	68	54	41	38	38	71	70	58	45	42	43						
	150	71	0.07	17	57	46	-	-	-	-	61	54	36	26	21	22	62	60	45	31	27	27	63	62	53	36	32	32	62	61	55	39	34	35	63	62	56	44	39	40						
6	50	24	0.01	2	54	40	-	-	-	-	56	48	35	-	-	-	55	46	36	23	20	24	58	48	39	27	25	30	56	48	41	29	26	32	58	50	43	30	29	37						
	550	260	0.66	165	72	65	53	43	38	36	* * * * *	74	68	56	46	41	39	77	71	58	49	43	42	77	72	59	50	43	43	81	76	61	52	46	46											
	400	189	0.37	91	64	57	45	34	27	25	66	61	47	37	30	28	70	65	50	40	33	33	74	69	54	44	37	37	75	69	54	45	40	40	76	72	57	47	44	45						
	250	118	0.15	38	57	47	32	-	-	-	61	54	39	29	21	22	66	60	44	35	28	30	68	62	49	38	34	35	68	63	52	39	36	38	70	66	57	43	41	42						
7	75	35	0.02	4	57	41	-	-	-	-	57	48	37	-	-	-	56	49	46	28	21	25	58	50	47	34	28	29	58	49	46	33	30	32	56	51	48	34	33	37						
	800	378	0.91	226	75	72	58	49	46	43	* * * * *	78	75	58	49	46	42	82	80	64	50	47	47	85	83	68	51	49	49	87	87	73	55	53	53											
	750	354	0.81	200	74	71	56	47	44	41	* * * * *	76	73	57	47	44	42	80	77	62	50	47	46	82	80	65	50	48	48	87	85	70	54	52	53											
	550	260	0.45	111	66	61	48	38	34	30	68	62	48	38	34	30	74	72	54	41	38	38	80	76	62	45	43	44	82	79	64	47	45	46	81	82	68	50	48	49						
8	100	47	0.02	4	56	40	-	-	-	-	56	46	28	-	-	-	54	47	33	-	-	24	57	51	39	25	25	28	57	48	36	24	26	32	57	51	38	26	28	35						
	950	448	0.97	241	76	72	61	52	49	46	* * * * *	75	72	61	52	49	46	80	77	64	54	51	49	82	80	65	54	51	50	86	84	70	56	54	53											
	700	330	0.54	134	68	64	52	44	40	37	* * * * *	74	70	56	45	42	40	79	76	60	47	45	44	80	78	64	48	47	46	84	83	69	52	51	51											
	450	212	0.23	57	57	51	40	31	25	21	64	60	45	33	30	27	71	69	54	38	36	36	76	74	59	41	40	41	75	74	59	42	41	43	76	75	59	43	44	47						
9	125	59	0.02	4	55	40	-	-	-	-	53	45	30	-	-	-	52	48	35	-	21	30	57	51	40	24	28	35	56	51	40	26	31	35	56	54	42	27	34	41						
	1200	566	0.54	134	73	64	53	44	41	39	* * * * *	78	71	55	44	42	42	83	75	59	47	46	47	86	77	60	48	48	49	89	83	65	51	51	53											
	900	425	0.31	77	65	56	45	35	32	30	69	62	46	35	32	31	75	68	52	40	38	39	81	73	56	44	43	44	83	77	58	45	44	46	85	79	62	48	48	50						
	600	283	0.14	35	58	45	33	22	-	-	68	59	42	30	27	28	73	66	48	35	34	36	75	69	51	38	37	39	76	70	52	40	39	41	77	71	54	43	42	45						
10	175	83	0.01	2	55	39	-	-	-	-	56	43	-	-	-	-	55	43	31	-	20	28	56	46	35	24	25	29	56	46	36	25	29	33	57	49	38	27	30	39						
	1600	755	0.77	191	77	70	59	51	48	45	* * * * *	78	71	59	51	47	45	84	76	62	52	49	48	87	78	63	53	50	50	91	84	66	55	54	54											
	1100	519	0.37	93	69	58	48	40	36	33	70	61	48	39	36	33	77	69	53	42	40	40	83	74	57	46	44	45	84	75	59	47	46	47	88	81	63	50	50	51						
	600	283	0.12	29	54	44	31	-	-	-	65	58	41	28	26	27	73	65	49	35	34	35	76	69	52	38	37	39	75	69	52	40	38	41	77	71	54	42	41	44						
12	225	106	0.02	4	52	37	-	-	-	-	55	43	26	-	-	20	55	46	34	-	20	26	57	49	39	29	27	34	57	49	40	28	29	38	58	51	43	31	33	43						
	2200	1038	1.09	271	81	75	65	57	55	52	* * * * *	* * * * *	* * * * *	84	77	66	58	56	54	87	79	67	58	56	54	90	84	70	59	58	57															
	1600	755	0.58	144	73	65	55	48	46	43	* * * * *	* * * * *	78	70	58	48	47	45	82	75	61	51	49	48	84	78	62	51	50	49	87	82	67	53	53	54										
	1000	472	0.23	58	60	52	43	34	31	29	67	59	46	36	33	31	75	68	52	39	38	38	78	73	57	43	42	43	79	74	59	44	45	46	81	77	62	48	50	52						
14	300	142	0.02	4	53	39	-	-	-	-	56	50	36	-	20	24	57	52	41	25	24	29	59	54	46	30	30	34	60	55	48	33	33	38	62	58	51	36	38	43						
	2900	1369	0.91	226	80	73	63	56	53	51	* * * * *	81	73	63	56	54	51	84	77	67	59	57	54	85	79	67	58	56	54	88	82	68	59	58	57											
	2100	991	0.49	121	73	63	54	47	44	41	73	63	54	47	44	41	77	68	57	49	46	44	80	73	59	50	48	48	81	76	60	51	50	50	84	79	64	53	53	54						
	1300	613	0.19	48	58	49	41	32	29	23	66	57	45	35	33	30	73	64	50	39	38	39	76	69	54	42	43	44	78	71	56	43	45	46	80	75	60	47	50	52						
400	189	0.02	4	53	41	-	-	-	-	56	47	32	-	21	24	59	51	39	26	28	35	63	55	44	31	34	39	62	55	45	31	37	42	63	55	48	33	40	47							

For performance table notes, see page B30; highlighted numbers indicate embedded AHRI certification points.

Performance Data • Radiated Sound Power Levels Model 3240 • With Mixing Attenuator • "BlendMaster™" Steri-Liner



Inlet Size	Airflow		Min. inlet ΔPs		Sound Power Octave Bands @ Inlet Pressure (ΔPs) shown																																									
					Minimum ΔPs							0.5" w.g. (125Pa) ΔPs							1.0" w.g. (250Pa) ΔPs							1.5" w.g. (375Pa) ΔPs							2.0" w.g. (500Pa) ΔPs							3.0" w.g. (750Pa) ΔPs						
					2	3	4	5	6	7	2	3	4	5	6	7	2	3	4	5	6	7	2	3	4	5	6	7	2	3	4	5	6	7	2	3	4	5	6	7						
4	200	94	0.49	123	-	33	27	23	-	-	45	38	29	29	27	23	49	44	33	31	32	27	52	48	37	34	35	31	53	50	39	36	37	34	54	51	42	38	39	38						
	150	71	0.29	72	-	31	24	20	-	-	43	36	26	26	23	20	47	42	30	28	28	24	50	46	34	31	31	28	51	48	38	33	33	31	52	49	41	37	35	35						
	100	47	0.14	34	-	-	21	-	-	-	-	35	25	25	23	-	-	41	29	27	26	25	46	46	34	30	29	31	50	47	38	32	31	32	49	45	41	37	34	37						
	25	12	0.01	2	-	-	-	-	-	-	31	29	21	-	-	-	35	39	28	23	22	22	34	32	35	27	23	27	44	32	41	31	25	29	39	29	40	38	31	35						
5	350	165	0.43	106	50	42	37	32	35	27	53	43	34	33	31	29	55	46	36	35	35	29	57	52	40	38	39	33	57	55	42	39	41	35	59	57	46	41	43	40						
	250	118	0.21	51	-	34	29	25	20	-	46	39	31	31	29	24	50	45	35	33	34	28	53	49	39	36	37	32	54	51	41	38	39	35	55	52	44	40	41	39						
	150	71	0.07	17	-	26	26	-	-	-	39	36	29	28	26	17	44	43	33	31	30	26	49	46	38	34	33	31	51	47	41	36	35	33	51	47	44	40	38	38						
	50	24	0.01	2	-	-	-	-	-	-	-	28	22	21	-	-	31	40	29	25	24	23	38	37	35	29	26	28	44	37	40	32	28	31	41	34	41	38	32	36						
6	550	260	0.66	165	54	48	39	39	36	33	*	*	*	*	*	*	59	52	42	41	40	33	62	57	45	42	43	38	63	59	46	44	45	40	65	62	50	45	47	44						
	400	189	0.37	91	50	42	37	32	30	27	53	46	38	36	35	29	55	49	40	38	38	32	58	53	44	41	41	36	60	56	46	42	43	38	61	59	49	45	46	43						
	250	118	0.15	38	44	33	32	23	-	-	45	40	34	32	31	24	50	47	38	35	35	29	52	49	42	38	38	34	55	51	45	40	40	36	55	52	47	43	43	41						
	75	35	0.02	4	27	-	-	-	-	-	24	25	24	23	23	-	36	40	30	27	27	25	38	38	37	31	29	29	43	39	42	34	31	31	39	36	43	40	35	37						
7	800	378	0.91	226	58	54	45	41	35	33	*	*	*	*	*	*	59	60	47	42	36	32	65	64	49	45	40	37	68	67	54	45	42	40	72	71	59	50	46	44						
	750	354	0.81	200	57	52	43	40	34	32	*	*	*	*	*	*	58	59	46	41	35	32	64	64	49	44	40	37	67	66	53	45	41	40	71	70	58	49	45	44						
	550	260	0.45	111	51	46	37	34	28	26	51	46	37	34	28	26	56	54	42	38	33	30	61	59	47	41	37	35	64	63	50	42	39	38	68	67	55	46	43	42						
	100	47	0.02	4	-	-	-	-	-	-	48	36	26	24	22	23	51	36	27	25	28	28	42	37	27	27	29	32	41	37	31	29	31	35	42	38	30	29	32	39						
8	950	448	0.97	241	59	54	45	41	36	32	*	*	*	*	*	*	61	61	49	44	37	35	68	67	53	47	42	39	71	70	57	48	44	42	75	74	62	52	47	46						
	700	330	0.54	134	54	49	40	37	31	29	*	*	*	*	*	*	59	57	45	41	36	33	64	62	50	44	40	38	67	66	53	45	42	41	71	70	58	49	46	45						
	450	212	0.23	57	47	40	31	28	22	24	51	46	36	33	29	26	58	53	42	37	34	32	59	57	43	40	37	36	59	58	47	41	39	39	62	61	50	44	42	43						
	125	59	0.02	4	27	-	-	-	-	-	44	37	26	24	23	22	51	40	29	26	28	28	43	40	26	28	30	32	40	38	31	29	31	35	40	37	29	30	33	39						
9	1200	566	0.54	134	55	50	42	35	29	28	*	*	*	*	*	*	65	59	47	42	38	42	68	64	51	44	40	44	71	67	54	48	42	44	71	70	57	51	44	45						
	900	425	0.31	77	53	46	38	31	27	26	54	48	40	34	29	27	62	56	45	40	36	34	66	62	49	43	39	43	69	65	52	46	41	43	71	69	56	49	43	44						
	600	283	0.14	35	50	37	29	22	24	23	50	45	35	31	27	24	57	52	41	36	32	38	59	56	45	38	35	37	60	58	48	41	37	38	61	61	51	44	38	40						
	175	83	0.01	2	42	-	-	-	-	-	40	36	23	21	-	-	44	41	30	25	23	30	41	42	33	28	24	25	40	43	36	30	26	27	41	45	39	33	28	31						
10	1600	755	0.77	191	63	58	49	42	39	36	*	*	*	*	*	*	66	61	50	44	39	37	71	66	53	47	43	45	74	69	56	50	45	47	74	73	60	53	47	47						
	1100	519	0.37	93	54	47	39	32	28	27	55	49	41	35	30	28	63	57	46	41	37	35	67	63	50	44	40	44	70	66	53	47	42	44	72	70	57	50	44	45						
	600	283	0.12	29	39	31	23	-	-	-	50	45	35	31	27	-	56	52	41	35	32	34	57	55	44	38	34	36	58	58	47	41	36	38	59	60	50	44	38	40						
	225	106	0.02	4	-	-	-	-	-	-	40	36	24	22	-	-	47	43	32	27	25	30	44	45	35	29	26	28	43	46	38	31	28	28	44	47	41	34	29	33						
12	2200	1038	1.09	271	68	63	44	35	42	39	*	*	*	*	*	*	*	*	*	*	*	*	73	70	56	51	48	41	77	74	60	54	48	44	79	77	65	58	53	49						
	1600	755	0.58	144	59	53	42	35	28	23	*	*	*	*	*	*	66	61	49	45	44	33	69	67	54	49	46	39	72	70	58	52	46	43	75	74	62	55	50	47						
	1000	472	0.23	58	47	40	29	26	-	-	55	49	38	39	30	-	60	56	45	41	37	32	62	59	49	45	41	36	63	62	52	47	42	40	66	65	56	50	44	45						
	300	142	0.02	4	-	-	-	-	-	-	-	39	26	-	-	-	51	49	37	29	24	26	52	50	39	32	27	29	52	52	40	35	29	32	53	53	42	42	35	37						
14	2900	1369	0.91	226	67	62	44	35	37	36	*	*	*	*	*	*	69	65	52	47	44	35	73	70	56	51	47	41	77	73	60	54	48	44	79	77	64	58	52	49						
	2100	991	0.49	121	59	53	42	35	28	23	59	53	42	35	28	23	66	61	49	45	44	33	69	67	54	49	46	39	72	70	58	52	46	43	75	74	62	55	50	47						
	1300	613	0.19	48	47	39	29	26	23	-	55	48	37	36	30	23	59	55	45	41	37	32	61	59	49	45	41	36	63	61	52	47	42	40	65	64	56	49	44	45						
	400	189	0.02	4	-	-	-	-	-	-	45	35	26	31	33	23	45	41	33	32	27	28	44	43	39	36	32	30	42	44	41	37	33	35	46	46	43	37	31	39						

For performance table notes, see page B30; highlighted numbers indicate embedded AHRI certification points.

Performance Data • AHRI Certification and Performance Notes

Model 3240 • With Mixing Attenuator • "BlendMaster™" • AHRI Certification Rating Points
Steri-Liner

Inlet Size	Airflow		Min. Inlet ΔPs		Discharge Sound Power Levels @ 1.5" w.g. (375 Pa) ΔPs							Radiated Sound Power Levels @ 1.5" w.g. (375 Pa) ΔPs						
	cfm	l/s	"w.g. Pa		Octave Band							Octave Band						
			2	3	4	5	6	7	2	3	4	5	6	7				
4	150	71	0.29	72	65	64	51	41	38	37	50	46	34	31	31	28		
5	250	118	0.21	51	68	67	51	40	36	37	53	49	39	36	37	32		
6	400	189	0.37	91	74	69	54	44	37	37	58	53	44	41	41	36		
7	550	260	0.45	111	80	76	62	45	43	44	61	59	47	41	37	35		
8	700	330	0.54	134	79	76	60	47	45	44	64	62	50	44	40	38		
9	900	425	0.31	77	81	73	56	44	43	44	66	62	49	43	39	43		
10	1100	519	0.37	93	83	74	57	46	44	45	67	63	50	44	40	44		
12	1600	755	0.58	144	82	75	61	51	49	48	69	67	54	49	46	39		
14	2100	991	0.49	121	80	73	59	50	48	48	69	67	54	49	46	39		



Ratings are certified in accordance with AHRI Standards.

Performance Notes for Sound Power Levels:

1. Discharge sound power is the noise emitted from the unit discharge into the downstream duct. Discharge Sound Power Levels (SWL) now include duct end reflection energy as part of the standard rating. Including the duct end correction provides sound power levels that would normally be transmitted into an acoustically, non-reflective duct. The effect of including the energy correction to the discharge SWL, is higher sound power levels when compared to previous AHRI certified data. For more information on duct end reflection calculations see AHRI Standard 880.
2. Radiated sound power is the breakout noise transmitted through the unit casing walls.
3. Sound power levels are in decibels, dB re 10⁻¹² watts.
4. All sound data listed by octave bands is raw data without any corrections for room absorption or duct attenuation. Dash (-) in space indicates sound power level is less than 20 dB or equal to background.
5. Minimum inlet ΔPs is the minimum operating pressure requirement of the unit (damper full open) and the difference in static pressure from inlet to discharge of the unit.
6. Asterisk (*) in space indicates that the minimum inlet static pressure requirement is greater than 0.5" w.g. (125 Pa) at rated airflow.
7. Data derived from independent tests conducted in accordance with ANSI/ASHRAE Standard 130 and AHRI Standard 880.

B DUAL DUCT TERMINAL UNITS

Performance Data Explanation

Sound Power Levels vs. NC Levels

The **Nailor Models: 3210, 3230 and 3240** dual duct terminal unit performance data is presented in two forms.

The laboratory obtained discharge and radiated sound power levels in octave bands 2 through 7 (125 through 4000 Hz) center frequency for each unit size at various flow rates and inlet static pressures is presented. This data is derived in accordance with ANSI/ASHRAE Standard 130 and AHRI Standard 880. This data is "raw" with no attenuation deductions and includes AHRI Certification standard rating points.

Nailor also provides an NC Level table as an application aid in terminal selection, which include attenuation allowances as explained below. The suggested attenuation allowances are not representative of specific job site conditions. It is recommended that the sound power level data be used and a detailed NC calculation be performed using the procedures outlined in AHRI Standard 885, Appendix E for accurate space sound levels.

Explanation of NC Levels

Tabulated NC levels are based on attenuation values as outlined in AHRI Standard 885 "Procedure for Estimating Occupied Space Sound Levels in the Application of Air Terminals and Air Outlets". AHRI Standard 885, Appendix E provides typical sound attenuation values for air terminal discharge sound and air terminal radiated sound.

As stated in AHRI Standard 885, Appendix E, "These values can be used as a quick method of estimating space sound levels when a detailed evaluation is not available. The attenuation values are required for use by manufacturers to catalog application sound levels. In product catalogs, the end user environments are not known and the following factors are provided as typical attenuation values. Use of these values will allow better comparison between manufacturers and give the end user a value which will be expected to be applicable for many types of space."

Radiated Sound

Table E1 of Appendix E provides radiated sound attenuation values for three types of ceiling: Type 1 – Glass Fiber; Type 2 – Mineral Fiber; Type 3 – Solid Gypsum Board.

Since Mineral Fiber tile ceilings are the most common construction used in commercial buildings, these values have been used to tabulate Radiated NC levels.

The following table provides the calculation method for the radiated sound total attenuation values based on AHRI Standard 885.

	Octave Band					
	2	3	4	5	6	7
Environmental Effect	2	1	0	0	0	0
Ceiling/Space Effect	16	18	20	26	31	36
Total Attenuation Deduction	18	19	20	26	31	36

The ceiling/space effect assumes the following conditions:

1. 5/8" (16) tile, 20 lb/ft³ (320 kg/m³) density.
2. The plenum is at least 3 feet (914) deep.
3. The plenum space is either wide (over 30 feet [9 m]) or lined with insulation.
4. The ceiling has no significant penetration directly under the unit.

Discharge Sound

Table E1 of Appendix E provides typical discharge sound attenuation values for three sizes of terminal unit.

1. Small box: Less than 300 cfm (142 l/s)
(Discharge Duct 8" x 8" [203 x 203]).
2. Medium box: 300 – 700 cfm (142 - 330 l/s)
(Discharge Duct 12" x 12" [305 x 305]).
3. Large box: Greater than 700 cfm (330 l/s)
(Discharge Duct 15" x 15" [381 x 381]).

These attenuation values have been used to tabulate Discharge NC levels applied against the terminal airflow volume and not terminal unit size.

The following tables provide the calculation method for the discharge sound total attenuation values based on AHRI Standard 885.

Small Box <300 cfm	Octave Band					
	2	3	4	5	6	7
Environmental Effect	2	1	0	0	0	0
5 ft. (1.5 m) 1" (25) Duct Lining	2	6	12	25	29	18
Branch Power Division (1 outlet)	0	0	0	0	0	0
5 ft. (1.5 m), 8 in. dia. (203) Flex Duct	5	10	18	19	21	12
End Reflection	10	5	2	1	0	0
Space Effect	5	6	7	8	9	10
Total Attenuation Deduction	24	28	39	53	59	40

Medium Box 300 – 700 cfm	Octave Band					
	2	3	4	5	6	7
Environmental Effect	2	1	0	0	0	0
5 ft. (1.5 m) 1" (25) Duct Lining	2	4	10	20	20	14
Branch Power Division (2 outlets)	3	3	3	3	3	3
5 ft. (1.5 m), 8 in. dia. (203) Flex Duct	5	10	18	19	21	12
End Reflection	10	5	2	1	0	0
Space Effect	5	6	7	8	9	10
Total Attenuation Deduction	27	29	40	51	53	39

Large Box >700 cfm	Octave Band					
	2	3	4	5	6	7
Environmental Effect	2	1	0	0	0	0
5 ft. (1.5 m) 1" (25) Duct Lining	2	3	9	18	17	12
Branch Power Division (3 outlets)	5	5	5	5	5	5
5 ft. (1.5 m), 8 in. dia. (203) Flex Duct	5	10	18	19	21	12
End Reflection	10	5	2	1	0	0
Space Effect	5	6	7	8	9	10
Total Attenuation Deduction	29	30	41	51	52	39

1. Flexible duct is non-metallic with 1" (25) insulation.
2. Space effect (room size and receiver location) 2500 ft.³ (69 m³) and 5 ft. (1.5 m) distance from source.

For a complete explanation of the attenuation factors and the procedures for calculating room NC levels, please refer to the acoustical engineering guidelines in the Nailor Terminal Units Catalog and AHRI Standard 885.

Liner Options

Multiple liner options are available on Model Series 3200, Dual Duct Terminal Units. Ranging from standard fiberglass to IAQ types, each liner addresses concerns with fiberglass erosion and conforms to a variety of lining and insulation requirements.

Dual Duct

Dual Density Fiberglass

Nailor uses dual density blanket-type fiber glass insulation with a high density skin on the exposed side and a low density core. The 4 lb. high density skin aids in resisting abrasion and erosion from airflow. Furthermore, Nailor coats all exposed edges with NFPA 90A approved sealant to reduce erosion and the entrainment of fibers into the airstream.

Fiberglass liner contributes to indoor comfort by lowering heat loss or gain through duct walls. Additionally, fiberglass liner enhances indoor environmental quality by absorbing sound within duct. The thermal and acoustical absorption of fiberglass is generally classified as excellent.

- Standard liner for Model Series 3200.
- 3/4" (19) thick dual density insulation, 4 lb./cu. ft. (64 kg/m³) skin and 1.5 lb./cu. ft. (24 kg/m³) core with exposed edges coated to reduce air erosion.
- 1" (25) thick dual density insulation optional.

Meets requirements:

- UL 181 & 723
- NFPA 90A & 90B
- ASTM E 84, C 1071
- CAN/ULC S102-M88

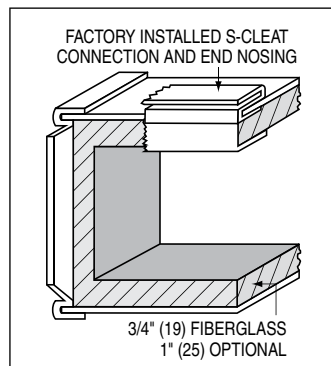

Steri-Liner

Steri-Liner is an internal insulation designed to reduce the risk of microbial growth within the terminal. A smooth non-porous facing provides a vapor barrier to moisture and reduces the risk of microorganisms becoming trapped. This facing also facilitates cleaning and prevents insulating material erosion. Damage to the liner, will expose fiberglass particles to the airstream.

Acoustic absorption of aluminum foil lined insulation is reduced for discharge sound levels and essentially unchanged for radiated sound levels when compared to standard fiberglass insulation.

- 13/16" (21) thick, 4 lb./cu. ft. (64 kg/m³) density rigid fiberglass with a fire resistant reinforced aluminum foil-scrim-kraft (FSK) facing.
- 1" (25) thick steri-liner insulation optional.

- No exposed edges. Steri-Liner features notch and tuck fabrication and full seam length steel Z-strip construction providing both superior edge protection and an extremely rigid terminal.

Meets requirements:

- UL 181 & 723
- NFPA 90A & 90B
- ASTM E 84, C 665, C 1071, C 1338, G21 & G22

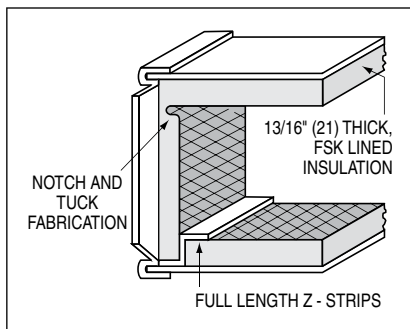

Fiber Free Liner

Nailor's Fiber-Free liner is a closed cell elastomeric foam. This liner has excellent insulating characteristics and provides acoustical attenuation roughly equivalent to Steri-Liner. The construction of fiber free insulation prevents the insulation from absorbing water, helping to reduce the likelihood of mold or bacterial growth.

- 3/4" (19) thick closed cell elastomeric foam.
- Smooth washable surface helps to prevent dirt and debris from accumulating.

Meets requirements:

- UL 181 & 723
- ASTM E 84, C 209, C 665
- CAN/ULC S102-M88

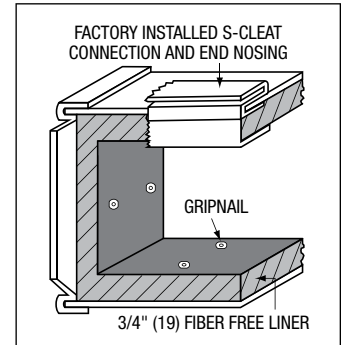

Perforated Metal Liner

Standard dual density fiberglass insulation covered with a 50% free area perforated metal sheet, constructed of steel, as a duct liner. The perforated metal sheet provides additional protection against erosion by airflow, but does not prevent moisture from contacting the insulation. Small fiberglass particles may escape through the metal perforations should the skin of the insulation be compromised.

- 22 ga. (0.86) perforated steel liner.
- 3/4" (19) dual density fiberglass insulation, 4 lb./cu. ft. (64 kg/m³) skin.

Meets requirements:

- UL 181 & 723
- ASTM E 84, C 665, C 1071

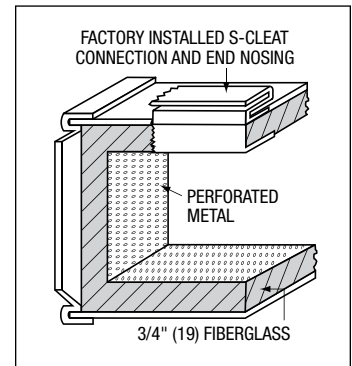

Solid Metal Liner

Nailor offers a solid inner metal liner that completely isolates the standard fiberglass liner from the airstream. Solid metal liners offer the ultimate protection against exposure of fiberglass particles to the airstream, all but eliminating the possibility of punctures that expose fiberglass. This option is also resistant to moisture. The encased insulation still provides thermal resistance and radiated sound attenuation, but acoustic absorption of discharge sound is eliminated. Solid Metal fabrication is a box within a box and uses metal end nosing to encapsulate exposed edges of the insulation.

- Solid inner liner is 22 ga. (0.86) steel.
- 3/4" (19) dual density fiberglass insulation, 4 lb./cu. ft. (64 kg/m³) skin and 1.5 lb./cu. ft. (24 kg/m³) core.

Meets requirements:

- UL 181 & 723
- ASTM E 84, C 655, C 1071
- NFPA 90A & 90B

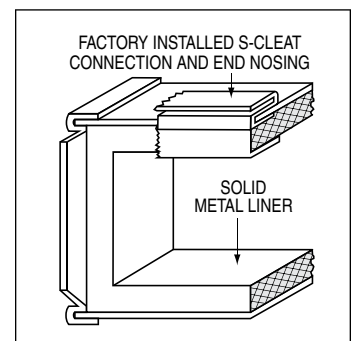

Options:

Access Door

Optional on 3230 and 3240 Dual Duct Terminal Units is an ultra-low leakage oval access door. The model 0800 type M1 double flanged surface mounted door allows for inspection and cleaning of dampers or mixing baffles. Each door features a positive bulb seal and uses easy opening twin camlock fasteners to seal the door against the surface mounted inner flange.

Standard Construction

- Die formed 22 ga. (0.86) galvanized steel flanged and door panel.
- 1" (25) insulation with 22 ga. (0.86) galvanized backing plate.
- Plated steel camlock fasteners.
- Positive bulb door seal.

Leakage Information

Tested in conformance to British Standard DW142 Class C. The maximum leakage at 8" w.g. (2 kPa): 18 x 10 (457 x 254): 0.133 cfm (3.78 l/min.)

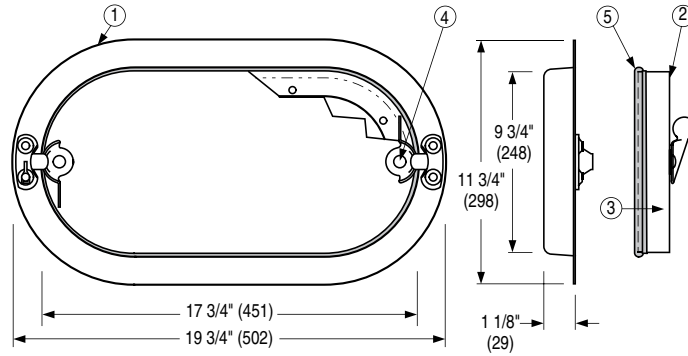

Diamond Flow Sensor Locations

All dual duct terminal units utilize pressure independent controls which require two flow sensors. When selecting dual duct terminal units for specific application, it is necessary to specify the correct flow sensor location.

For pneumatic control sequences with mixing, our standard construction is one sensor located in the cold duct inlet and one downstream total flow sensor (hot duct control). This configuration accommodates all standard constant and variable volume sequences. Optional hot inlet and cold total flow sensor configurations are available. Non-mixing pneumatic control sequences (Model 3210) are supplied with a cold and hot inlet sensor.

For analog electronic control sequences, sensor location is dependent on the sequence selected and the controller/ actuator/thermostat combination desired. Contact your Nailor Representative for further assistance.

When DDC controls are being supplied by the controls contractor for factory or field mounting, the sensor location will depend on the model of controls, application and the hand of the terminal unit. Coordination with the controls contractor is required to determine the appropriate sensor locations.

Multi-point flow sensors are available in three different configurations to suit any application control requirement. These are:

- Cold and hot duct inlet sensors (3A)
- Hot duct inlet sensor and downstream total sensor (3B)
- Cold duct inlet sensor and downstream total sensor (3C)

For all sensor location configurations, the hand inlet of the terminal unit (cold duct right hand or cold duct left hand) is required. Coordinate with your Nailor representative.

- Cold duct right hand (OR)
- Cold duct left hand (OL)

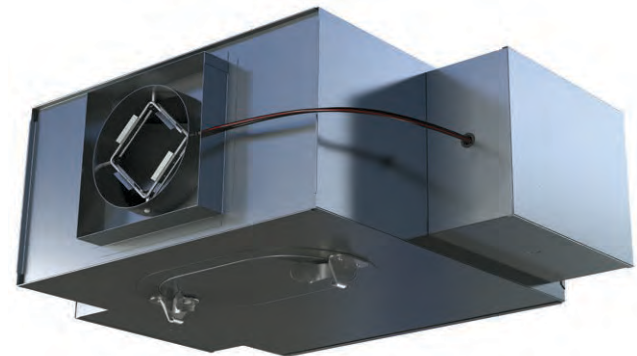

Model 3230 inlet and discharge outlet view illustrating a total (discharge) flow sensing configuration where the right hand deck (hot or cold) is under thermostat control.

B
DUAL DUCT TERMINAL UNITS

Sensor Location/Cold Duct Hand Options (plan view)

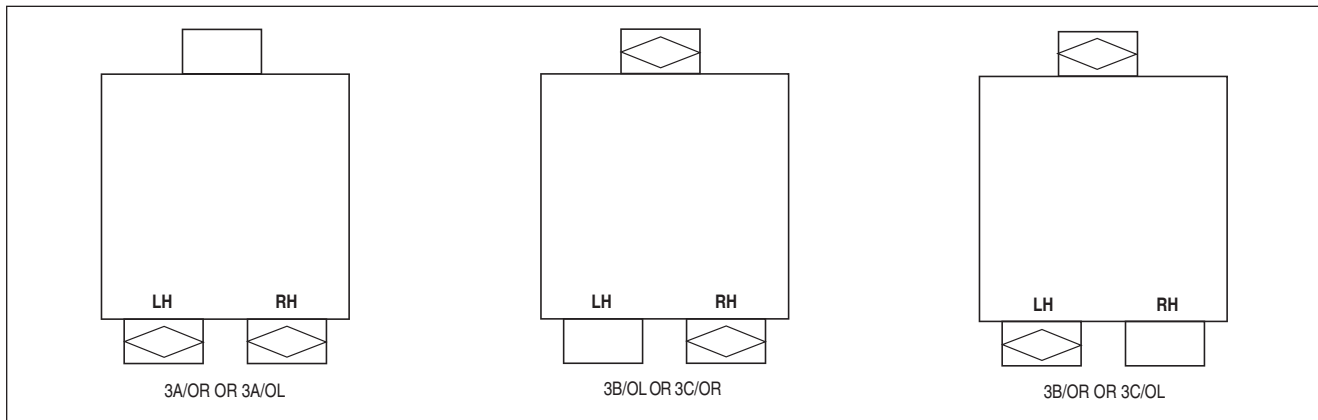

FAN POWERED TERMINAL UNITS

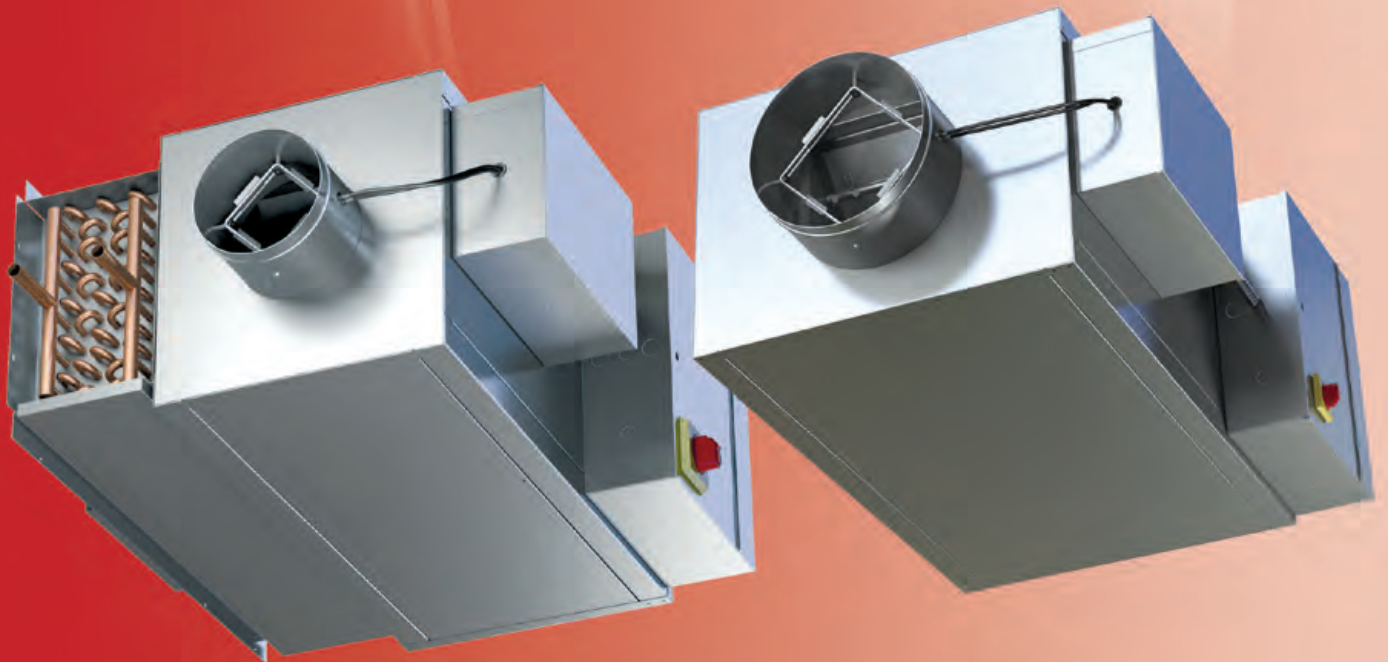

TABLE OF CONTENTS

Page No.

Product Overview		C6
Design Characteristics and Application		C7
Summary of Fan Powered Terminal Units		C9
Common Fan Terminal Components		C10
ECM/EPIC Fan Technology®		C11
Recommended Airflow Ranges for all Fan Powered Terminal Units		C13
Introduction and Features		
33SZ	• No Heat • FPCWTU (DOAS) • Series Flow	C14
33SZE	• Electric Heat • FPCWTU (DOAS) • Series Flow	
33SZW	• Hot Water Heat • FPCWTU (DOAS) • Series Flow	
Standard and Optional Features of the 33SZ		C15
Dimensional Data		
33SZ	• Unit Sizes 10 & 30 (Low Profile)	C16
	• Unit Size 35 (Low Profile)	C17
	• Unit Sizes 40, 50 & 55	C18
33SZW	• Hot Water Coil	C19
33SZE	• Electric Coil	C20
33SZ	• With 90° Line Voltage Enclosure (FN2 Option)	
	- Unit Sizes 10 & 30 (Low Profile)	C21
	- Unit Size 35 (Low Profile)	C22
	- Unit Size 40, 50 & 55	C23
33SZW	• Hot Water Coil with 90° Line Voltage Enclosure (FN2 Option)	C24
33SZE	• Electric Coil with 90° Line Voltage Enclosure (FN2 Option)	C25
33SZ	• Accessories • Universal Ducted Return Filter Rack	C26
	• Stealth™ Induced Dissipative Silencer	
Performance Data		
33SZ Series	• ECM Motor Fan Curves	C27
	• NC Level Application Guide	C29
	• Discharge Sound Power Levels	C31
	• Radiated Sound Power Levels	C33
	• Performance Notes	C35
	• Sensible Chilled Water Coil • Unit Size 10	C36
	• Hot Water Coil • Unit Size 10	C37
	• Sensible Chilled Water Coil • Unit Size 30	C38
	• Hot Water Coil • Unit Size 30	C39
	• Sensible Chilled Water Coil • Unit Size 35	C40
	• Hot Water Coil • Unit Size 35	C41
	• Sensible Chilled Water Coil • Unit Size 40	C42
	• Hot Water Coil • Unit Size 40	C43
	• Sensible Chilled Water Coil • Unit Size 50	C44
	• Hot Water Coil • Unit Size 50	C45
	• Sensible Chilled Water Coil • Unit Size 55	C46
	• Hot Water Coil • Unit Size 55	C47
Introduction and Features		
35S	• No Heat • Series Flow	C48
35SE	• Electric Heat • Series Flow	
35SW	• Hot Water Heat • Series Flow	
Standard and Optional Features of the 35S		C49
Dimensional Data		
35S	• Unit Sizes 1 – 6	C50
	• Unit Size 7	C51
35SW	• Hot Water Coil	C52
35SE	• Electric Coil	C53

TABLE OF CONTENTS

	Page No.
Performance Data	
35S Series	
• PSC Motor Fan Curves	C54
• ECM Motor Fan Curves	C56
• NC Level Application Guide	C58
• Discharge Sound Power Levels	C59
• Radiated Sound Power Levels	C60
• AHRI Certification and Performance Notes	C61
Introduction and Features	
35SST	C62
35SEST	
35SWST	
Standard and Optional Features of the 35S	C63
Dimensional Data	
35SST	
• Unit Sizes 1 – 6	C64
• Unit Size 7	C65
35SWST	C66
35SEST	C67
Performance Data	
35SST	
• PSC Motor Fan Curves	C68
• ECM Motor Fan Curves	C70
• NC Level Application Guide	C71
• Discharge Sound Power Levels	C73
• Radiated Sound Power Levels	C74
• AHRI Certification and Performance Notes	C75
Introduction and Features	
35S-OAI	C76
35SE-OAI	
35SW-OAI	
35SST-OAI	
35SEST-OAI	
35SWST-OAI	
Dimensional Data	
35S-OAI	
• Unit Sizes 2 – 6	C77
• Unit Size 7	C78
35SW-OAI	C79
35SE-OAI	C80
35SST-OAI	C81
35SWST-OAI	C82
35SEST-OAI	
Introduction and Features	
35S-CVP	C83
35SE-CVP	
35SW-CVP	
Dimensional Data	
35S-CVP	
• Unit Sizes 3, 5, 7	C84
35SW-CVP	C85
35SE-CVP	C86
Performance Data	
35S-CVP Series • ECM Motor Fan Curves	C87
Performance Data • Hot Water Coil	
Models: 35SW, 35SWST, 35SW-OAI, 35SWST-OAI, 35SW-CVP	C88

TABLE OF CONTENTS

Page No.

Introduction and Features

35SXC	• No Heat • Stealth XC • Series Flow	C94
35SEXC	• Electric Heat • Stealth XC • Series Flow	
35SWXC	• Hot Water Heat • Stealth XC • Series Flow	

Control Sequences **C95**

A Series Fan Powered Box for Exposed Ceiling Applications **C96**

Dimensional Data

35SXC	• Unit Sizes 1, 3, 5	C98
35SWXC	• Hot Water Coil	C99
35SEXC	• Electric Heat	

Performance Data

35SXC	• EPIC ECM Motor Fan Curves	C100
	• NC Level Application Guide	C101
	• Discharge Sound Power Levels	C102
	• Radiated Sound Power Levels	C103
	• AHRI Certification and Performance Notes	C104

Performance Data • Hot Water Coil

Model: 35SWXC		C105
---------------	--	-------------

Introduction and Features

37S	• No Heat • Low Profile • Series Flow	C108
37SE	• Electric Heat • Low Profile • Series Flow	
37SW	• Hot Water Heat • Low Profile • Series Flow	

Dimensional Data

37S	• Unit Sizes 1, 2, 3	C109
	• Unit Size 4	C110
37SW	• Hot Water Coil	C111
37SE	• Electric Heat	C112

Performance Data

37S Series	• PSC Motor Fan Curves	C113
	• ECM Motor Fan Curves	C114
	• NC Level Application Guide	C115
	• Discharge Sound Power Levels	C116
	• Radiated Sound Power Levels	C117
	• AHRI Certification and Performance Notes	C118

Introduction and Features

37SST	• No Heat • Stealth™ • Low Profile	C119
37SEST	• Electric Heat • Stealth™ • Low Profile	
37SWST	• Hot Water Heat • Stealth™ • Low Profile	

Dimensional Data

37SST	• Unit Sizes 1, 2, 3	C120
	• Unit Size 4	C121
37SWST	• Hot Water Coil	C122
37SEST	• Electric Heat	C123

Performance Data

37SST Series	• PSC Motor Fan Curves	C124
	• ECM Motor Fan Curves	C125
	• NC Level Application Guide	C126
	• Discharge Sound Power Levels	C127
	• Radiated Sound Power Levels	C128
	• AHRI Certification and Performance Notes	C129

TABLE OF CONTENTS

	Page No.
Performance Data • Hot Water Coil	
Models: 37SW and 37SWST	C130
Introduction and Features	
35N • No Heat • Parallel Flow	C133
35NE • Electric Heat • Parallel Flow	
35NW • Hot Water Heat • Parallel Flow	
Dimensional Data	
35N • Unit Sizes 2, 3, 5, 6	C134
35NW • Hot Water Coil	C135
35NE • Electric Heat	
Performance Data	
35N Series • PSC Motor Fan Curves	C136
• ECM Motor Fan Curves	C137
• NC Level Application Guide • Cooling Cycle	C138
• Discharge Sound Power Levels • Cooling Cycle	C139
• Radiated Sound Power Levels • Cooling Cycle	C140
• NC Level Application Guide • Heating Cycle	C141
• Discharge and Radiated Sound Power Levels • Heating Cycle	
• AHRI Certification and Performance Notes	C142
Performance Data • Hot Water Coil	
Model: 35NW	C143
Introduction and Features	
37N • Parallel Flow • Low Profile	C147
37NE • Electric Heat • Parallel Flow • Low Profile	
37NW • Hot Water Coil • Parallel Flow • Low Profile	
Dimensional Data	
37N • Unit Sizes 2, 3, 4	C148
37NW • Hot Water Coil	C149
37NE • Electric Heat	
Performance Data	
37N Series • PSC Motor Fan Curves	C150
• ECM Motor Fan Curves	C151
• NC Level Application Guide • Cooling Cycle	C152
• Discharge Sound Power Levels • Cooling Cycle	C153
• Radiated Sound Power Levels • Cooling Cycle	C154
• NC Level Application Guide • Heating Cycle	C155
• Discharge and Radiated Sound Power Levels • Heating Cycle	
• AHRI Certification and Performance Notes	C156
Performance Data • Hot Water Coil	
Model: 37NW	C157
Performance Data Explanation	C160
Electric Heating Coils	
• Features, Selection and Capacities	C161
• Application Guidelines	C162
Optional Terminal Unit Liners for IAQ Sensitive Applications	C163
Line Voltage Enclosure Options • Low Temperature Construction	C164

GENERAL PRODUCT OVERVIEW

Leading The Industry

Providing products that incorporate the desires and requirements of the industry we serve has traditionally been a primary focus at Nailor.

We listened in-depth to the engineering and contracting community, asked a lot of questions and realized there was not a single line of fan powered terminals available that incorporated all the design features and performance criteria that satisfied their wishes.

After an extensive and intense period of research, design and development, we have produced a line of fan powered terminals that satisfy the vast majority of requirements the HVAC industry demands.

On the next page, you can see at a glance some of the unique universal features that have been incorporated into Nailor fan powered terminals, providing the benefits of high performance operation and many field-friendly features to aid installation.

All Nailor terminals include the following additional features as standard:

- Compatibility with digital, analog electronic and pneumatic controls.
- Fan motors and heaters are energized and dielectric tests are performed on every terminal to ensure correct operation prior to shipment.
- Custom fabricated motor/blower combinations are mounted on special heavy gauge angles and isolated from casing with rubber insulators.
- All motors incorporate an anti-backward rotation design to prevent backward rotation upon start-up.
- Units can be flipped in the field for right or left hand configuration except Model Series 33SZ.

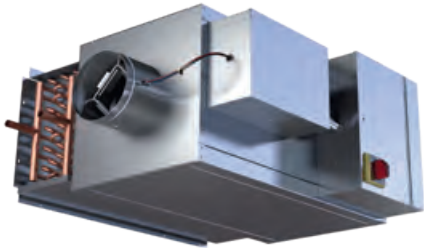

Model Series 33SZ. Basic Unit
Chilled Water, Series Flow, (Constant or Variable Volume)

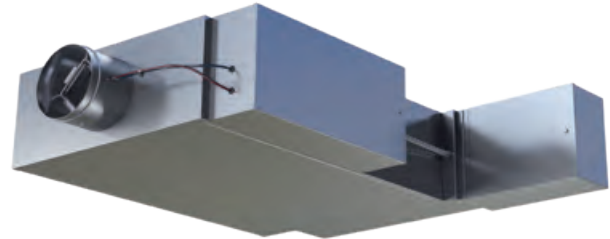

Model Series 37SE, Electric Heat
Series Flow (Constant or Variable Volume)

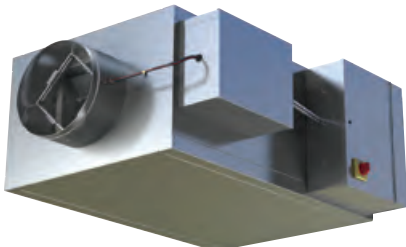

Model Series 35S. Basic Unit
Series Flow (Constant or Variable Volume)

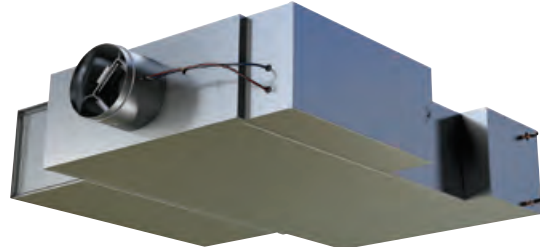

Model Series 37SST Stealth™, Hot Water Heat
Super Quiet, Series Flow (Constant or Variable Volume)

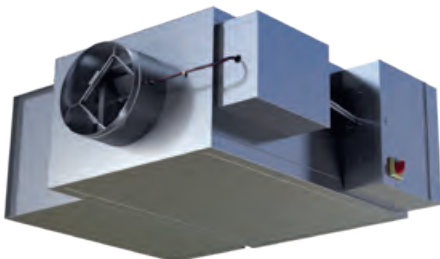

Model Series 35SST Stealth™, Hot Water Heat
Super Quiet, Series Flow (Constant or Variable Volume)



Model Series 35NW, Hot Water Heat
Compact Design, Parallel Flow (Variable Volume)

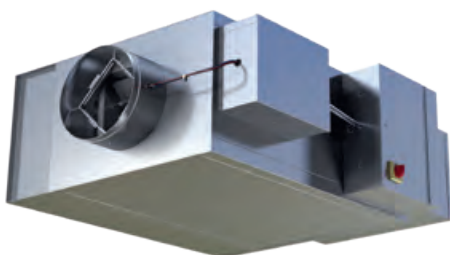

Model Series 35SEXC Stealth™, Electric Heat
Super Quiet, Series Flow (Variable Volume)

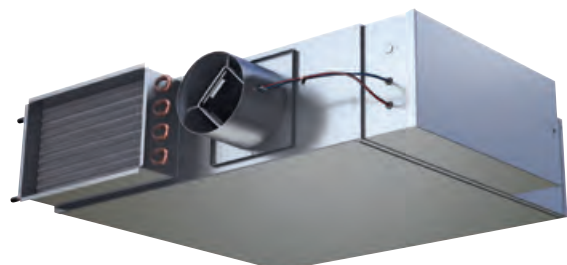

Model Series 37NW, Hot Water Heat
Low Profile Design, Parallel Flow (Variable Volume)

Design Characteristics and Application

Introduction

Fan Powered Terminal Units are an economical means of both cooling and periodically heating the perimeter zones of a building utilizing a single duct control system. In addition to inherent VAV economies, fan terminals utilize the free heat derived from lighting, people and other equipment and induce this warmer plenum air from the building core ceiling plenum space and re-circulate it to rooms calling for heating. If additional heating is required, optional supplementary heating coils may be activated. The need for a central source of warm air is eliminated.

During weekend or night-time operation, the central fans may be turned off. Heat, if required, may be provided by the terminal unit fan itself.

Fan Powered Terminal Units are the most popular design for office buildings because they provide performance benefits by reducing first cost, (such as lower central system fan HP and smaller ductwork), lower operating cost, the recovery of waste heat, and the capacity for improved air circulation and diffuser performance.

Fan terminals are available in two basic configurations; series or parallel flow. Each contains a fan motor assembly and a variable air volume damper to modulate primary air.

In a series unit (Fig. 1), the fan sits in the primary air stream and runs constantly when the zone is occupied. In a parallel unit (Fig. 2), the fan sits outside the primary air stream and runs intermittently.

Although both terminals can provide central fan HP savings, each terminal has different inlet static pressure requirements. Series fan terminals boost both induced air and primary air, so the inlet static pressure only needs to overcome the loss across the damper [less than 0.05" w.g. (12 Pa)] with Nailor terminals. Parallel fan terminals require enough static pressure to overcome the losses across the damper, the downstream ductwork and diffusers [typically 0.25 — 0.5" w.g. (62 — 124 Pa)] with Nailor terminals.

Series Flow Terminals – (Constant Volume)

A series fan powered terminal unit mixes primary air with induced plenum air by using a continuously operating fan during the occupied mode. It provides a constant volume of air to the space regardless of load.

As the cooling load decreases, the zone thermostat throttles the primary air valve. The terminal fan makes up the difference by inducing more return air from the plenum. At low cooling loads, the primary air may close or go to a minimum ventilation setting. If the zone temperature drops still further, the thermostat can energize optional supplemental heat. The sequence reverses when the load is increased.

The series terminal is therefore a constant volume, variable temperature unit. (See Fig. 3).

Series units should only be used with pressure independent controls. Series fans must be adjusted to match the maximum

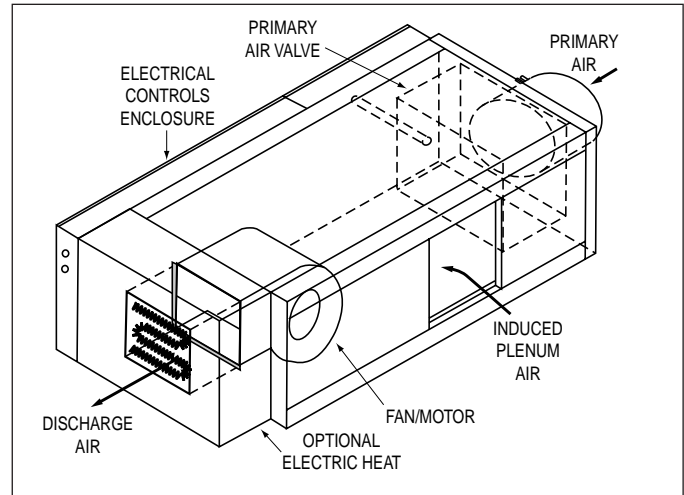

Figure 1. Series Fan Terminal

cooling cfm, to ensure that the primary air does not exceed the fan cfm as this would result in the short-circuiting of primary air directly into the ceiling plenum and waste energy. A pressure independent controller and inlet flow sensor controls the primary air valve to compensate for changes in inlet static pressure and ensures design cfm is maintained.

Parallel Flow Terminals – (Variable Volume)

Also called an intermittent fan terminal unit, a parallel unit modulates primary air in response to cooling demand and energizes the integral fan in sequence to deliver induced air to meet heating demand. The induction fan operating range should slightly overlap the range of the primary air valve. A backdraft damper ahead of the terminal fan restricts conditioned air from escaping into the return air plenum when the fan is off.

During full cooling demand, the thermostat positions the primary air valve for full airflow while the fan is de-energized. As the cooling load decreases, less primary air is delivered to the zone as the thermostat modulates the valve (functioning as a single duct VAV terminal).

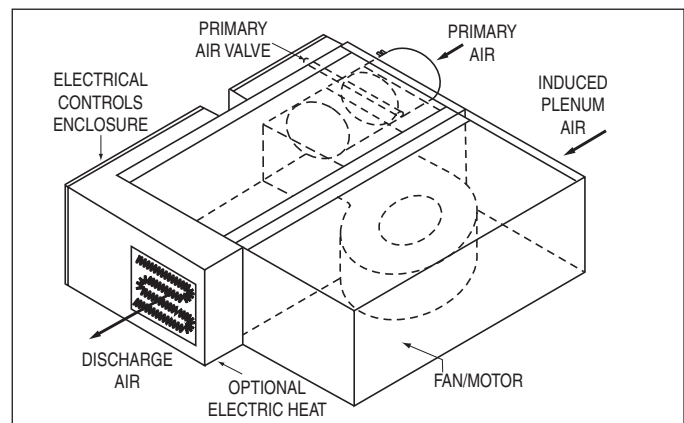

Figure 2. Parallel Fan Terminal

Design Characteristics and Application (continued)

The primary air damper may be set to a minimum position, (to ensure continuous ventilation), or zero (closed). At a reduced demand for cooling, the fan becomes energized. The fan has an adjustable starting point and may alternatively be set to energize at the point that the primary air valve reaches its minimum position or before it reaches its minimum setting. Overlapping the fan start point and primary air valve minimizes the likelihood of air stagnation in the conditioned space and the noticeable air surge when the fan energizes.

With the fan energized, the delivered air temperature approaches that of the ceiling plenum. If the zone temperature continues to drop, the thermostat automatically energizes optional supplemental electric or hot water heat, thereby raising discharge air temperature. Increasing the cooling load reverses the sequence. The parallel terminal unit is therefore variable volume constant temperature on the cooling cycle and essentially constant volume variable temperature on the heating cycle. (See Fig. 4).

Application

Fan terminals are installed in the ceiling return air plenum and take return air from the plenum or have the induction port(s) ducted to the space. For maximum heat pick-up and minimum sound radiation, the assembly should ideally be located in the ceiling cavity, preferably over a corridor, toward the building core.

Careful consideration should be given to both overall sound level and change in sound level in the space. With series terminals the sound remains virtually constant as the fan runs continuously. With parallel units, the intermittent fan operation will cause a change in sound levels in the occupied space. This change will be more noticeable than a constant

sound, even if the constant sound is at a higher level (i.e., a series unit), especially in the fall and spring when fan cycling occurs frequently.

When properly applied, the relatively long distance between the fan terminal discharge outlet and the conditioned space it serves minimizes any concern about discharge sounds in the space due to the terminal and only the radiated sound, below the space where it is located, need be considered.

Both the primary air damper and fan act as sound sources in both units and each generates discharged and radiated sound.

Series units will have the fan sized for the full airflow and downstream resistance. Parallel fans with a reduced air volume heating load should be sized for a reduced resistance downstream of the terminal. While series fans deliver the total design cooling air volume, parallel units generally deliver 50 to 75% of that amount. Therefore, series units usually require a larger fan or the same fan run at a higher speed.

Fan Powered Induction Systems combine the energy saving diversity of single duct VAV shut-off systems with the additional benefits of heat reclamation. In most climates, fan powered systems are a lower operating cost alternative. Plenum air heating eliminates the inefficiencies inherent in reheating cold primary air. Utilizing warmer plenum air allows for recovery of heat from lighting and other heat sources in the building.

Fan Powered Terminals move more air through a room at low reheat systems, thereby providing improved air circulation.

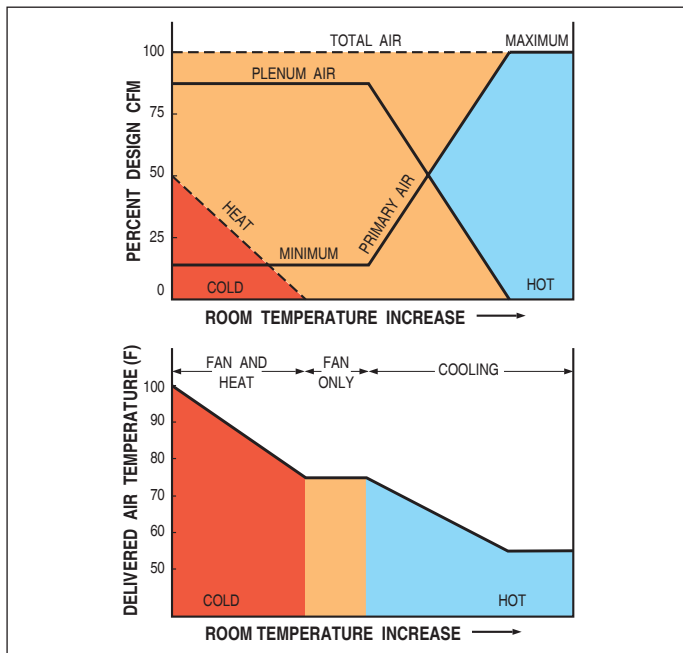

Figure 3. Series Operation

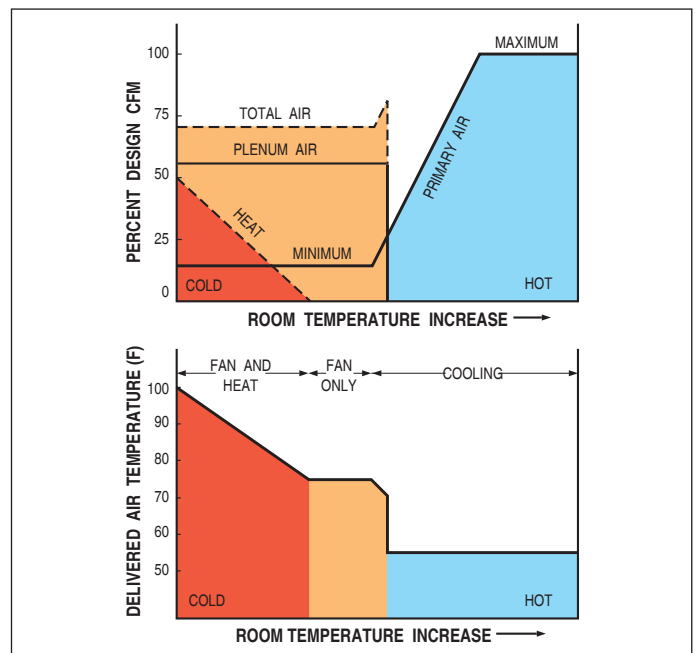

Figure 4. Parallel Operation

Design Characteristics and Application (continued)

Typical Application of Series Units

Series flow terminals are rapidly becoming the terminal of choice for their superior characteristics of constant volume delivery, temperature blending and constant sound levels as compared to parallel flow terminals.

Some applications may demand constant air volume delivery regardless of load, e.g., conference rooms, lobbies and large open office areas. Because the series unit supplies the downstream external static pressure and reduces the central system pressure requirement, office buildings can take advantage of this design feature and downsize central air handling equipment and associated ductwork. Series terminals are ideally suited for use in low temperature (ice storage) air systems to temper cold [40 – 48°F (4.4 – 9.0°C)] air with warm plenum air before delivering it to the zone

Typical Application of Parallel Units

Parallel units may be used in perimeter zones of buildings where loads vary during occupied hours and core zones maintain a near constant cooling requirement utilizing single duct shut-off type terminal units. Variable volume airflow to the zone is acceptable in these applications and low installation and operating costs are desired.

Energy Consumption and Installed Cost

Dependent upon location, loading, operating hours and ventilation requirements, either type of fan terminal may be more advantageous. For an equivalent zone size, series terminals may be a little higher in first cost as the fan is sized for total airflow whereas a parallel terminal fan is sized for the reduced heating airflow only. When fan size is the same however, installed cost is approximately equal.

Series terminals however unlike parallel, reduce the operating pressure requirement at the central AHU (Air Handling Unit).

Summary of Fan Powered Terminal Units

	Series Flow	Parallel Flow
Configuration	Fan located in the primary airstream.	Fan sits outside the primary airstream.
Fan Operation	Continuous operation during the occupied mode whether heating or cooling. Intermittent operation (night cycle) available during the unoccupied mode.	Intermittent operation during occupied and unoccupied (night cycle) periods. Fan cycles only under heating and minimum cooling loads in dead bands.
Operating Sequence	Constant or variable volume, variable temperature at all times. Primary and plenum air are mixed in varying amounts; supplemental heat raises temperature still further in stages. Delivers required airflow to satisfy load.	Variable volume, constant or variable temperature during cooling. Constant volume, variable temperature during heating. Fan and supplementary heat raise temperature in stages.
Fan Energization	Interlocked with central system fan to prevent air from spilling out of induction ports and into ceiling-plenum. Anti-backward rotation design feature built in.	Based upon zone demand from thermostat set point. No interlock with central system fan required. Anti-backward rotation design feature built-in.
Terminal Fan Sizing	Fan sizing should meet the greater of design cooling or heating airflow to the zone (usually 100% of cooling) at required downstream static pressure.	Size for design heating load (typically 40 to 75% of design primary cooling airflow) at reduced downstream static pressure.
Primary Air Valve Sizing & Minimum Pressure for Central Fan Sizing	Size for design cooling flow with sufficient inlet pressure [lower 0.05" w.g. to 0.20" w.g. (12 to 50 Pa)] to overcome primary air valve pressure loss only. Terminal fan provides static pressure for downstream losses. Requires lower horsepower central fan.	Size for design cooling flow with sufficient inlet pressure [higher 0.3" w.g. to 0.6" w.g. (75 to 149 pa)] to overcome terminal unit, heating coil, downstream duct and diffuser pressure losses. Requires higher horsepower central fan.
Acoustics	Continuous fan operation produces slightly higher (for a given volume), but constant sound pressure levels in the occupied space. This constant sound level may be less noticeable than an intermittent fan operation.	Fan does not run under cooling loads, offering acoustic performance similar to single duct VAV terminal with attenuator. Under heating loads, the fan cycles intermittently which changes sound pressure levels in the occupied space.
Ventilation Rates	High ventilation rates and room air movement helps ensure superior occupant comfort.	Variable – Possibility of air stagnation at reduced air volumes, particularly in larger zones with partitioned office space.

Common Fan Terminal Components

The Diamond Flow multi-point averaging sensor is standard on all Nailor terminal units that are equipped with pressure independent controls.

In addition to the Diamond Flow multi-point averaging sensor and opposed blade damper configuration of the primary air valve that are described in detail on page O11 in this catalog, all Nailor fan powered terminals incorporate the following features and benefits.

Single Speed PSC Induction Motors

All Nailor fan powered terminal units are currently equipped with single speed, direct drive, fractional horsepower, high efficiency, PSC motors as standard. These motors are manufactured to specifications developed by Nailor specifically for the fan powered terminal unit market. Some of the more important features of PSC motors are listed and explained below.

- **No Corona Effect**

Motors not only provide power, but act as transformers and generators. Under certain conditions, this causes the unused speed taps in multiple speed motors to have large potential or static charges present. While these charges are not doing any work, they will create damage to the windings if their potential voltages are greater than the winding insulating quality. This is often the case and lifetimes are shortened. Nailor fan powered terminal units do not suffer from this malady. All motors are single speed.

- **Wide Operating Ranges**

Nailor motors are designed to operate at rotational speeds lower than those of our competitors. This requires special stator wire sizing, special capacitor sizing and special bearings. These items are covered in our specifications. This assures you of high end performance equal to or better than any of our competitors and low end ranges below any of our competitors.

Low end performance is often ignored. Many times, this is because the range is not great enough to allow much difference, or because the low end performance is achieved by artificial means such as manual dampers to lower the airflows. Manual dampers lower airflows, but they increase RPM. Increased RPM puts back all the noise generated in the fan powered terminal unit as if it were still operating at full airflow. This is due to the noise caused by tip speed and vibration within the unit. High RPM, regardless of airflow will generate high noise.

Nailor solves this problem through low RPM for low airflows. Typically, the motors in Nailor fan powered terminal units can rotate as low as 350 RPM at low end, shedding as many as 14 to 20 decibels in the second and third octave bands depending on which unit is being selected. This means real sound level selections, units that can produce NC's of 30 and 35 when applied correctly and wider operating ranges on individual units for greater flexibility in the zone.

- **Permanently Lubricated Motors**

Nailor fan powered terminal units are equipped with permanently lubricated motors. The motors are equipped with oilers, but the oilers are not necessary as long as the units are operated in typical ambient temperature conditions. The specifications call for the oil reservoirs to have at least 50% of the original oil still in the reservoir after 50,000 hours of use under normal conditions.

- **Permanent Split Capacitor Design**

All Nailor fan powered terminal units are supplied with PSC motors as standard. The capacitors are sized to provide ample starting torque, even when turned down to the low minimums allowed on Nailor fan powered terminal units.

- **High Efficiency**

All Nailor PSC motors have the highest efficiency available in the market today. This too, is controlled by the Nailor motor specifications. Higher efficiency means lower operating expenses.

PSC Fan Speed Controllers

Nailor designed its own solid state fan speed controllers. They are designed to operate with the specific motor and blower combinations as used in Nailor fan powered terminal units. They provide smooth and infinite adjustment of motor speed from maximum to the lowest preset low end limits found in the industry.

The speed controllers are largely responsible for the operating ranges of the motors. High quality standards allow very accurate low end stops. This assures Nailor customers of sound levels and performance as cataloged.

The matching of the motors and speed controllers allows Nailor fan powered terminal units lower watt consumption as motor RPM's are reduced. High efficiency is maintained from high end performance to low end performance. Very few of our competitors can make a similar claim.

Low Noise Levels – AHRI Certified

In addition to those items listed above, Nailor holds down noise levels in the occupied space with heavy gauge metal casings, dual density insulation and multiple isolation points between motors and casings. Nailor is as quiet as any and far quieter than most of our competitors when controlling similar airflows on competitive equipment. Check out the sound data in this catalog. Notice there is no fine print covering the conditions under which the data does not apply. Notice that the minimum static requirement on series fan powered terminal units is 0.05" w.g. (12 Pa). Then notice the correspondingly low inlet static pressures on the parallel units. Notice that Nailor sound data is AHRI certified and independently certified by Energistics Laboratory, Houston. Compare that to the competition.

ECM/EPIC FAN TECHNOLOGY®

- Significant energy savings (67% typical compared to PSC motors)
- Unique factory pre-set air volume capability (+/- 5%)
- Pressure independent fan operation
- LED for visual indication of air volume
- Field adjustable fan air volume controller
- Remote fan air volume adjustment capability from BAS
- Larger turn down ratios mean more flexibility for tenant changes



Since 1985, equipment manufacturers have used ECM's in residential air conditioners and furnaces. These motors have made it possible to achieve SEER ratings of 12 and higher. Nailor first introduced the ECM to the commercial HVAC market (ASHRAE Journal, April 1997) as an option for use in series fan powered terminal unit applications.

WHAT IS AN ECM?

The ECM (Electronically Commutated Motor) is an ultra high efficiency programmable brushless DC motor utilizing a permanent magnet motor and a built-in AC/DC converter. DC motors are significantly more energy efficient than AC motors and much easier to control. The major weakness of series fan powered terminal units until now, has been their low fan motor efficiency. The widely used single speed fractional horsepower PSC (Permanent Split Capacitor) induction motor in combination with an electronic SCR speed controller is extremely inefficient at typical operating conditions. Due to acoustical considerations, the fan motor is usually adjusted to operate at considerably less than full load (where PSC motor efficiencies may be as high as 62%). PSC motor efficiency drops off dramatically when turned down; typically by at least half. Installed PSC motor efficiencies are therefore typically in the range of only 12 – 45%. ECM's in contrast, maintain a high efficiency of 78 – 83% at all speeds.

In addition to lower operating costs, ECM / EPIC Fan Technology® allows Nailor to pre-set the fan airflow volume at the factory for constant volume units or modulate the fan across wide ranges as zone loads change.

Figure 1. shows the lower watts per cfm translating into lower operating costs as shown on Figure 2, and wider operating ranges of series terminals employing ECM versus PSC induction motors.

FEATURES AND BENEFITS OF ECM

Soft starts and slewed speed ramps are programmed into the ECM eliminating stress transmitted to the mounting bracket or hardware. They incorporate ball bearings providing permanent lubrication unlike sleeve bearings requiring a minimum RPM operation for oiling. The wider operating range of the ECM allows much more flexibility in zone applications. This feature alone provides several benefits; a simpler

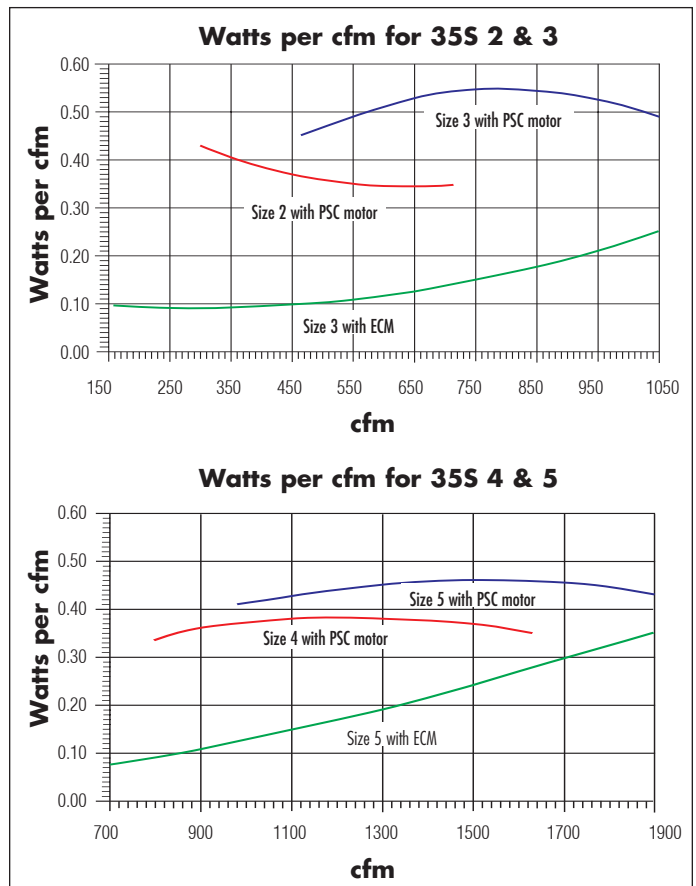

Figure 1. Power consumption comparison of ECM versus PSC motors.

product line to choose from, little or no equipment changes necessary when tenants change, more similar sized units on the job, decreased spare parts inventory and increased contractor flexibility. The low operating temperature of the ECM motor (essentially ambient) requires very little energy to offset the heat gain from the motor.

ECM/EPIC FAN TECHNOLOGY®

These features also extend the life of the ECM, which are expected to provide an average 90,000 hours of operation. This translates into about 25 years for a typical series fan powered terminal unit. In addition to these standard features are two primary benefits; energy savings and the ability to pre-set the fan airflow volume at the factory.

HOW DO YOU PRE-SET FAN AIRFLOW?

Pre-setting the fan airflow (cfm) has always been a problem for fan powered terminal manufacturers for two major reasons. First is that AC motors are not synchronous machines and second the RPM and consequently the unit cfm, changes when static pressure changes. The difficulty in pre-setting the fan lies in estimating the motor workload required at the job site in actual working conditions. The fan will not produce the same volume of air as it did at the factory without the duct work. Because there is no way to accurately predict the downstream static pressure as it would exist at the job site, it was impossible to pre-set the fan cfm. The ECM's are DC and inherently synchronous machines. The motors are programmed to calculate the work they are doing and then compare the work accomplished to the cfm requirement. The integral microprocessor based controller automatically adjusts the speed and torque in response to system pressure changes and pressure independent constant airflow operation is achieved without the need for an external flow sensor feedback loop.

Nailor series fan powered terminal units incorporate our own custom EPIC fan controller. An electronic PWM volume control device that allows adjustment of airflow volume. This value can be pre-set on the assembly line. It is field adjustable either manually using a screwdriver and voltmeter locally at the terminal or more conveniently, remotely using a 0 – 10 VDC analog output from a digital controller via the BAS. A fan volume versus DC volts calibration chart is provided. The importance of this feature is that the balancer never has to go into the ceiling to adjust the fan. This relieves the balancer of most of his work per zone on fan powered terminal units and related headaches. This also removes the uncertainty of diffuser flow measurement with hoods. Laboratory tests show the fan cfm to be accurate within +/- 5% of the factory set point. This is a huge benefit to the owner, the controls contractor, the mechanical contractor and the ceiling contractor.

ENERGY SAVINGS

The following graphs show the energy savings of units with ECM's compared to units with Nailor engineered PSC motors. Since PSC motors used by Nailor are built specifically for Nailor fan powered terminal units and are more efficient than those used by most of our competitors.

A comparison using Nailor units with ECM's and a competitor's units with PSC motors would show even greater savings.

The typical range of operation for the size 3 would be 200 to about 900 cfm (94 to 425 l/s). The typical range of operation for the size 5 unit would be 700 to 1700 cfm (330 to 802 l/s).

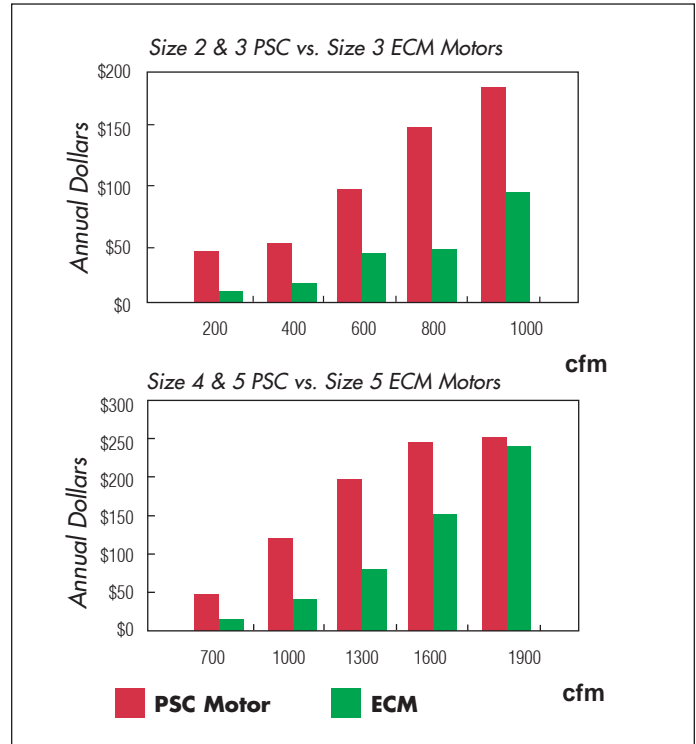

Figure 2. Typical operating cost comparison.

WHAT IS THE PAYBACK PERIOD ON ECM MOTORS?

The payback period varies. It depends on which unit you use, where you set the cfm, how much you run the equipment and what you are paying for electricity. The graphs above are calculated assuming 66 hours per week operations and \$.10 per kWh. If you run the equipment longer in your building or if you pay more for electricity, the payback will change proportionally. Considering the pre-set capability of the motor, there should be an up-front savings on balancing. That should be rebated to the owner and should be considered as part of the payback from the motor. Typically, with the balancing rebate and the operating expenses as shown above, the payback period should be anywhere from 6 to 18 months.

Recommended Primary Valve Airflow Ranges For All Fan Powered Terminal Units

The recommended airflow ranges below are for fan powered terminal units with pressure independent controls and are presented as ranges for total and controller specific minimum and maximum airflow. Airflow ranges are based upon maintaining reasonable sound levels and controller limits using Nailor's Diamond Flow Sensor as the airflow measuring device. For a given unit size, the minimum, auxiliary and the maximum flow setting must be within the range limits to ensure pressure independent operation, accuracy and repeatability.

Minimum airflow limits are based upon .02" w.g. (5 Pa) differential pressure signal from Diamond Flow Sensor on analog/digital controls and .03" (7.5) for pneumatic controllers. This is a realistic low limit for many transducers used in the digital controls industry. Check your controls supplier for minimum limits. Setting airflow minimums lower, may cause hunting and failure to meet minimum ventilation requirements.

The high end of the tabulated Total Airflow Range on pneumatic and analog electronic controls represents the Diamond Flow Sensor's differential pressure reading at 1" w.g. (249 Pa). The high end airflow range for digital controls is represented by the indicated transducer differential pressure.

ASHRAE 130 "Performance Rating of Air Terminals" is the method of test for the certification program. The "standard rating condition" (certification rating point) airflow volumes for each terminal unit size are tabulated below per AHRI Standard 880. These air volumes equate to an approximate inlet velocity of 2000 fpm (10.2 m/s).

When digital or other controls are mounted by Nailor, but supplied by others, these values are guidelines only, based upon experience with the majority of controls currently available. Controls supplied by others for factory mounting are configured and calibrated in the field. Airflow settings on pneumatic and analog controls supplied by Nailor are factory preset when provided.

Imperial Units, Cubic Feet per Minute

Inlet Size	Inlet Type	Total Airflow Range, cfm	Airflow at 2000 fpm Inlet Velocity (nom.), cfm	Range of Minimum and Maximum Settings, cfm							
				Pneumatic 3000 Controller		Analog Electronic Controls		Digital Controls			
						Transducer Differential Pressure (w.g.)					
				Min.	Max.	Min.	Max.	Min.	Max.	Max.	
.03	1.0	.02	1.0	.02	1.0	1.25	≥ 1.5				
4	Round	0 – 225	150	30	180	25	180	25	180	200	225
5		0 – 400	250	55	325	45	325	45	325	360	400
6		0 – 550	400	80	450	65	450	65	450	500	550
7		0 – 800	550	115	650	95	650	95	650	725	800
8		0 – 1100	700	155	900	125	900	125	900	1000	1100
10		0 – 1840	1100	260	1500	215	1500	215	1500	1675	1840
12		0 – 2500	1600	355	2050	290	2050	290	2050	2290	2500
14		0 – 3370	2100	475	2750	390	2750	390	2750	3075	3370
16		0 – 4510	2800	640	3700	520	3700	520	3700	4120	4510
12		Flat Oval	0 – 2500	1600	355	2050	290	2050	290	2050	2300
14	0 – 3125		2100	440	2550	360	2550	360	2550	2850	3125
16	0 – 3725		2800	525	3040	430	3040	430	3040	3400	3725
18	0 – 5265		3500	750	4300	610	4300	610	4300	4800	5265
14 x 8	Rect.	0 – 2450	1560	350	2000	290	2000	290	2000	2240	2450
14 x 10		0 – 2950	1900	420	2400	340	2400	340	2400	2700	2950

Metric Units, Liters per Second

Inlet Size	Inlet Type	Total Airflow Range, l/s	Airflow at 10.2 m/s Inlet Velocity (nom.), l/s	Range of Minimum and Maximum Settings, l/s							
				Pneumatic 3000 Controller		Analog Electronic Controls		Digital Controls			
						Transducer Differential Pressure (Pa)					
				Min.	Max.	Min.	Max.	Min.	Max.		
7.5	249	5	249	5	249	311	≥ 374				
4	Round	0 – 106	71	14	85	12	85	12	85	94	106
5		0 – 189	118	26	153	21	153	21	153	170	189
6		0 – 260	189	38	212	31	212	31	212	236	260
7		0 – 378	260	54	307	45	307	45	307	342	378
8		0 – 519	330	73	425	59	425	59	425	472	519
10		0 – 868	519	123	708	101	708	101	708	790	868
12		0 – 1180	755	168	967	137	967	137	967	1081	1080
14		0 – 1590	991	224	1298	184	1298	184	1298	1451	1590
16		0 – 2128	1321	302	1746	245	1746	245	1746	1944	2128
12		Flat Oval	0 – 1180	755	168	967	137	967	137	967	1085
14	0 – 1475		991	208	1203	170	1203	170	1203	1345	1475
16	0 – 1758		1321	248	1435	203	1435	203	1435	1604	1758
18	0 – 2485		1652	354	2029	288	2029	288	2029	2265	2485
14 x 8	Rect.	0 – 1156	736	165	944	137	944	137	944	1057	1156
14 x 10		0 – 1392	897	198	1133	160	1133	160	1133	1274	1392

SERIES FLOW • CONSTANT OR VARIABLE VOLUME

33SZ SERIES

- CHILLED WATER (SENSIBLE) COOLING COIL
- DOAS APPLICATIONS

Models:

- 33SZ** No Heat
- 33SZE** Electric Heat
- 33SZW** Hot Water Heat

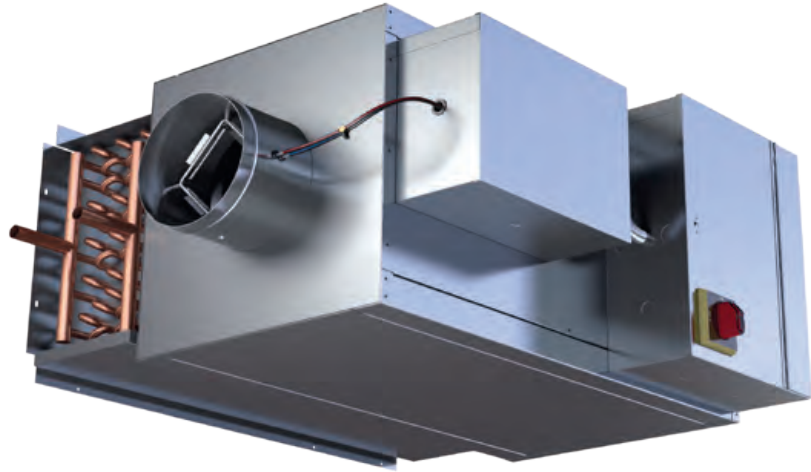

Model 33SZ

The **33SZ Series** Fan Powered Chilled Water Terminal Units (FPCWTU) enhance Nailor's already efficient and flexible Series Fan Terminal Unit product line. The 33SZ incorporates a cooling induction coil to use in conjunction with a DOAS (Dedicated Outdoor Air System). Useful in a variety of commercial and educational applications, like classrooms, office space, laboratories and auditoriums, the 33SZ provides a flexible, industry familiar unit that excels at zone sensible cooling while the dedicated outdoor air inlet delivers ASHRAE 62.1 ventilation requirements.

STANDARD FEATURES:

- Standard height and low-profile designs available.
- Sensible cooling coil on the induced air inlet handles zone sensible load. Opposite side to controls location. Coil is constructed of aluminum ripple fins (10 FPI) and 1/2" (13) copper tubes. Hand of coil is determined looking in direction of airflow.
- 18 ga. (1.31) galvanized steel channel frame with 20 ga. (1.0) casing components. Sizes 40 - 55.
- 20 ga. (1.0) galvanized steel casing construction. Sizes 10 - 30.
- 16 ga. (1.61) galvanized steel inclined opposed blade damper. 45° rotation. CW to close.
- Galvanized steel drip pan integral to sensible coil.
- Motor blower assembly mounted on special 16 ga. (1.61) angles and isolated from casing with rubber isolators.
- Discharge opening designed for flanged duct connection.
- Controls mounted as standard on RH side as shown. Terminals ordered with LH controls (optional) are inverted and discharge duct hanging elevation will therefore change.
- Single point electrical connection.
- Access panels top and bottom.

- Multi-point averaging Diamond Flow sensor.
- Low voltage NEMA 1 type enclosure for factory mounted digital controls.
- ECM/EPIC Fan Technology®.
- Dual density fiberglass insulation, exposed edges coated to prevent air erosion. Meets requirements of NFPA 90A and UL 181. 1/2" (13) thick on unit sizes 10, 30 and 35. 3/4" (19) thick on unit sizes 40 50 and 55.

OPTIONS:

CW Coil:

- 2-Row, 4-Row, 6-Row and 8-Row
- Right or Left Hand coil connections
- Condensate Sensor

Liner:

- Fiber-free liner
- Perforated metal liner
- Solid metal liner
- Steri-liner
- Steri-liner w/perforated liner

Silencer Section:

- Designed to mate with Coil section for optimum performance and quiet operation.
- Optimized internal baffle geometry reduces self-generated noise, maximizes acoustic attenuation.

- 22 ga. (0.86) coated steel perforated baffles with 13% free area encapsulate fiberglass acoustic media. Mylar lining with acoustical spacer isolates material from airstream.

Filter:

- 1" (25) Throwaway
- 2" (51) Pleated MERV 8
- 2" (51) Pleated MERV 13
- Ducted Return Filter Rack

Electrical:

- Left Hand Controls enclosure
- Toggle disconnect switch
- FN2 – 90° Line Voltage enclosure
- FN3 – Remote Line Voltage enclosure
- Motor fusing

Others:

- Hanger brackets
- 1/4-turn fasteners (access panel)

Seismic Certification:

- (Unit size 10 is pending)
- SSI (Standard)
 - OSHPD



Intertek

Standard and Optional Features of the 33SZ

- **Electric Heat Option** High efficiency arrowhead insulators eliminate glow and extend element life. Manufactured in-house by Nailor. Removable element rack.

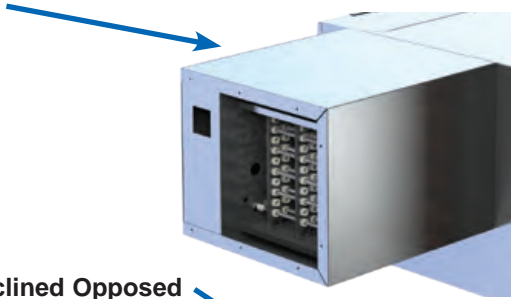

- **Hot Water Coils Option** Hydronic/Electric Hot Water Coils are fully encased and insulated. Nailor manufactures electric heating elements and can provide them in .1 kw increments.

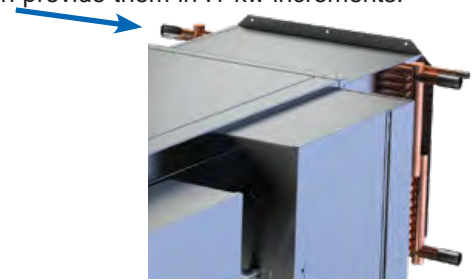

- **Inclined Opposed Blade Primary Air Damper** minimizes noisy turbulence and ensures smooth accurate control.

- **Multi-Point Diamond Flow Inlet Sensor**

Durable aluminum multi-point averaging Diamond Flow sensor is more robust than a plastic option and is accurate to +/-5%, even hard 90 elbow at the inlet.

- **18 ga. (1.31) channel space frame construction**

Provides structural strength and secure mounting for the 20 ga. insulated panels. These panels provide access on top, bottom and side of the unit. Several liner options for any application.

- **Universal Ducted Return Filter Rack**

Optional DRFR with paino-hinged door flap with latch on the side and bottom allows easy replacement of the filter.



- **Sensible Cooling Coil**

Cooling coils are available up to 8 rows to meet the needs of any application. Provided standard with drip pans.

- **3/4" (19) Dual Density Insulation** meets requirements of NFPA 90A and UL 181. Insulation with a high density skin, on the exposed side and a low density core.

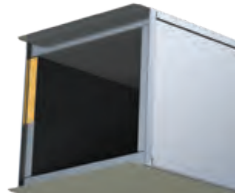

- **ECM Motor**

Highly efficient fan and motor combinations are specifically designed to handle advanced control sequences for the most efficient VAV systems.

- **Stealth™ Induced Air Dissipative Silencer**

Optional DSI provides maximum acoustic attenuation by reducing radiated sound power levels.

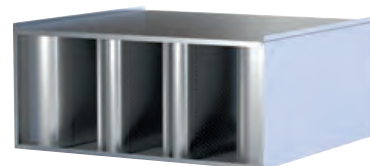

- **24V Controls Enclosure**

- **Line Voltage Enclosure** With optional FN2 90° enclosure hinged for easy access. Several mounting options, including remote, allow NEC code requirements to be met in tight spaces.



- **Remote Line Voltage Control Enclosure**

Optional FN3 on 48" (1219) umbilical.

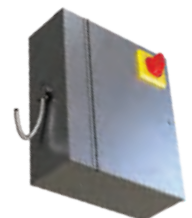

Dimensions

Model Series 33SZ • FPCWTU (DOAS) • Series Flow • Unit Sizes 10 & 30 (Low Profile)

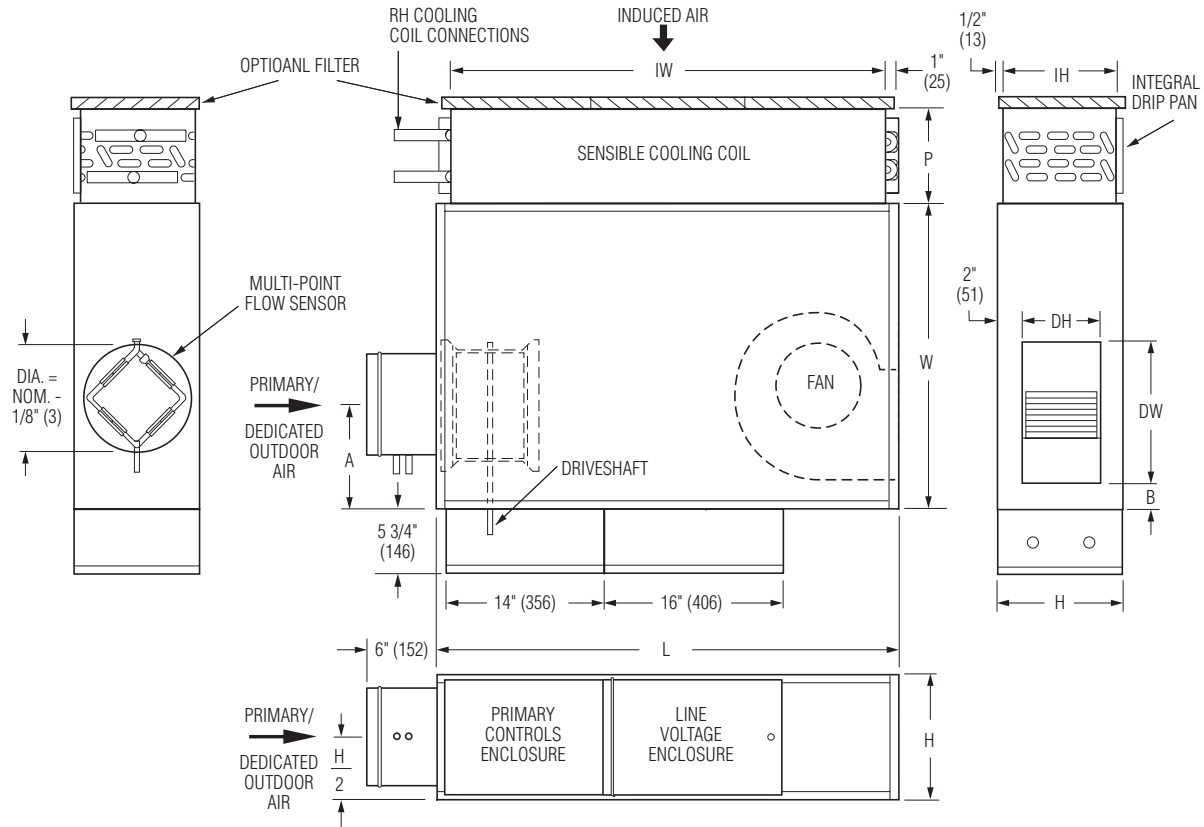

Dimensional Data

Unit Size	Inlet Size	W	H	L	A	B	Cooling Coil IW x IH	P	Outlet Discharge DW x DH	Filter Size
10	4, 6 (102, 152)	26 1/2 (673)	8 1/2 (216)	47 1/4 (1200)	5 1/8 (130)	2 (51)	43 x 7 1/2 (1092 x 191)	2 Row: 5 1/8 (130) 4 Row: 7 5/16 (186) 6 Row: 9 1/2 (241)	7 1/8 x 4 3/4 (181 x 121)	45 x 8 1/2 (1143 x 216)
30	4, 6, 8 (102, 152, 203)	26 1/2 (673)	11 (279)	40 1/4 (1022)	8 (203)	2 (51)	36 x 8 3/4 (914 x 222)	8 Row: 11 11/16 (297)	12 3/8 x 6 7/8 (314 x 175)	38 x 10 (965 x 254)

CW Coil O.D. Sweat Connections

Unit Size	No. of Row
10, 30	2, 4, 6 & 8
	7/8" (22)

FAN POWERED TERMINAL UNITS



Dimensions

Model Series 33SZ • FPCWTU (DOAS) • Series Flow • Unit Size 35 (Low Profile)

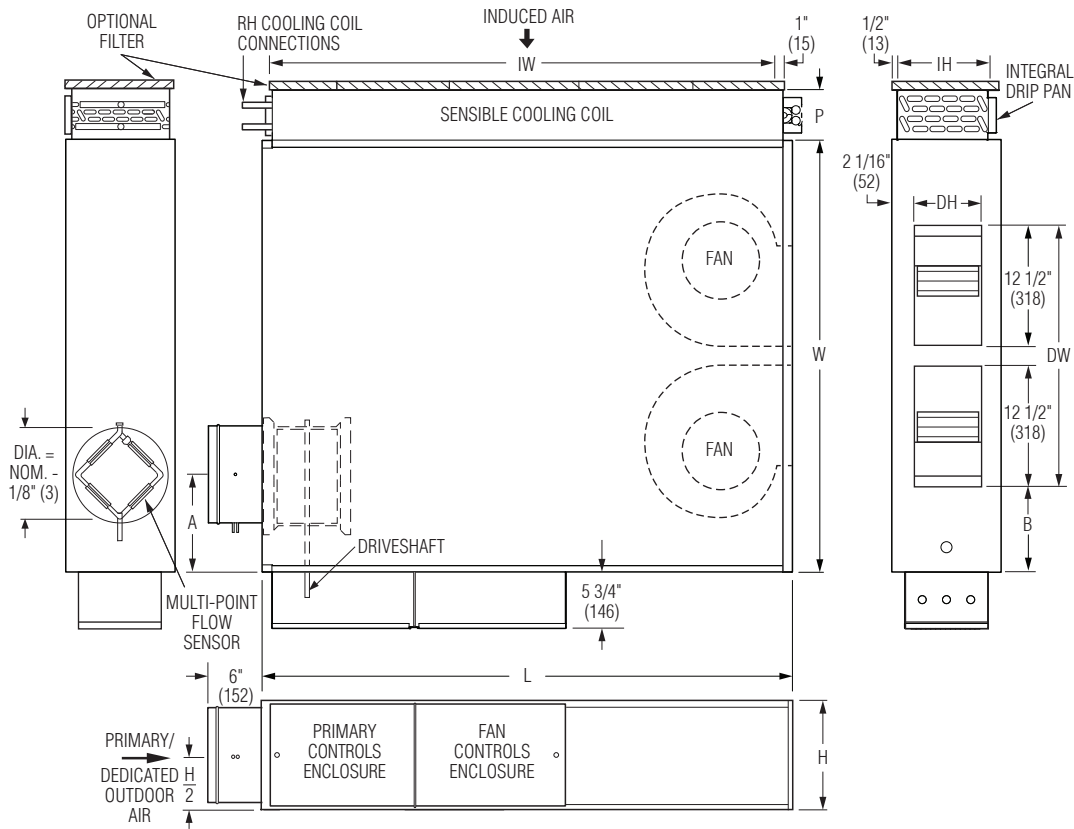

Dimensional Data

Unit Size	Inlet Size	W	H	L	A	B	Cooling Coil IW x IH	P	Outlet Discharge DW x DH	Filter Size
35	4, 5, 6, 8, 10 (102, 127, 152, 203, 254)	44 (1118)	11 (279)	54 (1372)	8 (203)	8 1/2 (216)	50 x 10 (1270 x 254)	2 Row: 5 1/8 (130) 4 Row: 7 5/16 (186) 6 Row: 9 1/2 (241) 8 Row: 11 1/2 (292)	27 x 6 7/8 (686 x 175)	2@ 26 x 11 (660 x 279)

CW Coil O.D. Sweat Connections

Unit Size	No. of Row
35	7/8" (22)

Dimensions

Model Series 33SZ • FPCWTU (DOAS) • Series Flow • Unit Sizes 40, 50 & 55

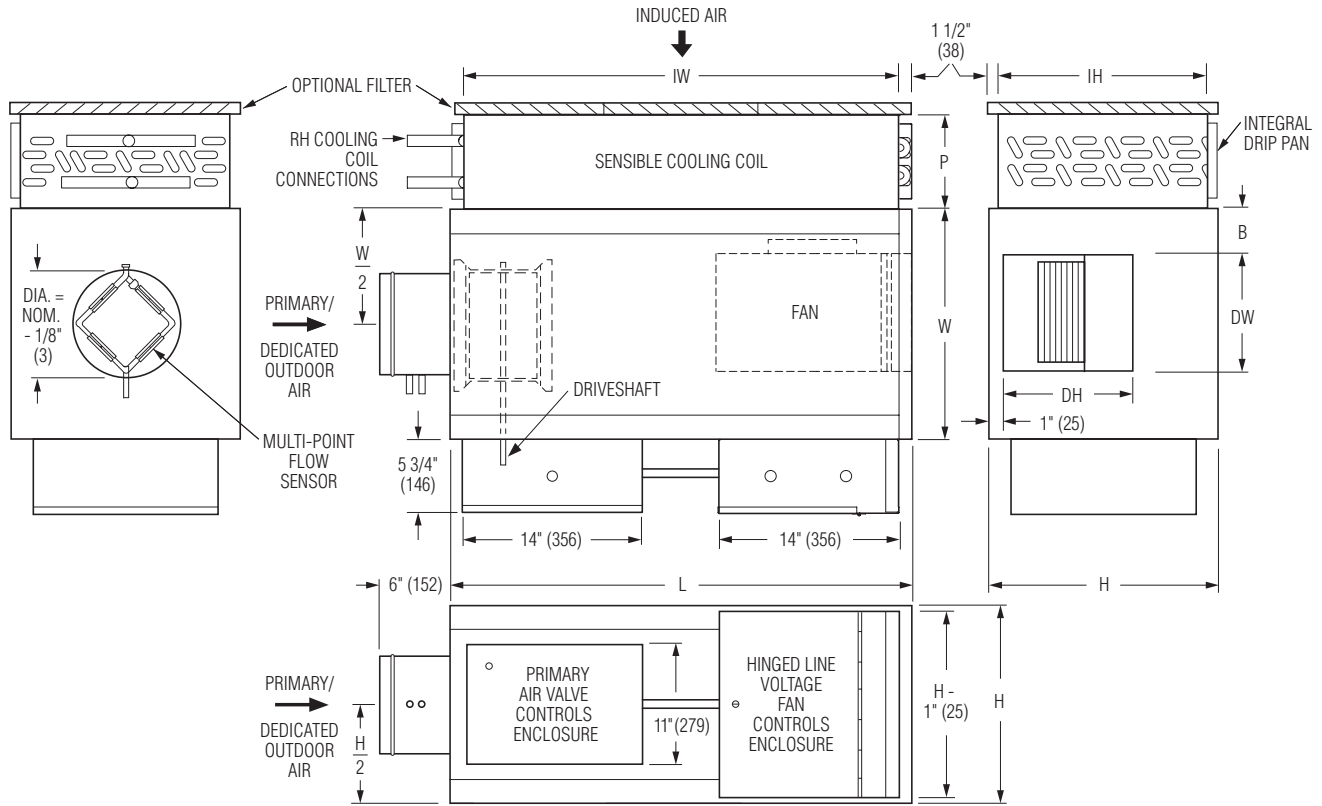

Dimensional Data

Unit Size	Inlet Size	W	H	L	B	Cooling Coil IW x IH	P	Outlet Discharge DW x DH	Filter Size
40	4, 6, 8, 10 (102, 152, 203, 254)	18 (457)	18 (457)	36 (914)	3 1/2 (89)	31 x 15 (787 x 381)	2 Row: 5 1/8 (130)	9 1/8 x 10 1/4 (232 x 260)	33 x 16 (838 x 406)
							4 Row: 7 5/16 (186)		
50	4, 6, 8, 10, 12 (102, 152, 203, 254, 305)	26 (660)	18 (457)	41 (1041)	5 (127)	36 x 15 (914 x 381)	6 Row: 9 1/2 (241)	13 1/8 x 11 1/4 (333 x 286)	38 x 16 (965 x 406)
							8 Row: 11 1/2 (292)		
55	6, 8, 10, 12, 14 (152, 203, 254, 305, 356)	26 (660)	18 (457)	55 (1397)	5 (127)	50 x 15 (1270 x 381)	6 Row: 9 1/2 (241) 8 Row: 11 1/2 (292)	13 1/8 x 11 1/4 (333 x 286)	52 x 16 (1321 x 406)

CW Coil O.D. Sweat Connections

Unit Size	No. of Row
	2, 4, 6 & 8
40, 50, 55	7/8" (22)

Dimensions

Model Series 33SZ • FPCWTU (DOAS) • Series Flow • Unit Sizes 10 - 55

Hot Water Coil Section

Model 33SZW

Available in one or two row. Coil section installed on unit discharge. Right hand coil connection looking in direction of airflow standard (shown). Left hand is optional.

Standard Features:

- Coil section installed on unit discharge.
- 1/2" (13) copper tubes.
- Aluminum ripple fins @10 FPI.
- Sweat Connections:
 - Sizes 10 & 30:
 - 1 Row: 1/2" (13)
 - 2 Row: 5/8" (16)
 - Size 35:
 - 1 Row: 1/2" (13)
 - 2 Row: 7/8" (22)
 - Sizes 40, 50 & 55
 - 1 Row: 7/8" (22)
 - 2 Row: 7/8" (22)
- Flanged outlet duct connection.

Coil Rows:

- 1-Row
- 2-Row

Coil Hand Connections:

(Looking in direction of airflow).

- Right Hand (illustrated). (Standard.)
- Left Hand. (Optional.)

Heating coil, sensible cooling coil and controls enclosure orientation must all be specified separately.

Unit Size 10 & 30 (Low Profile)

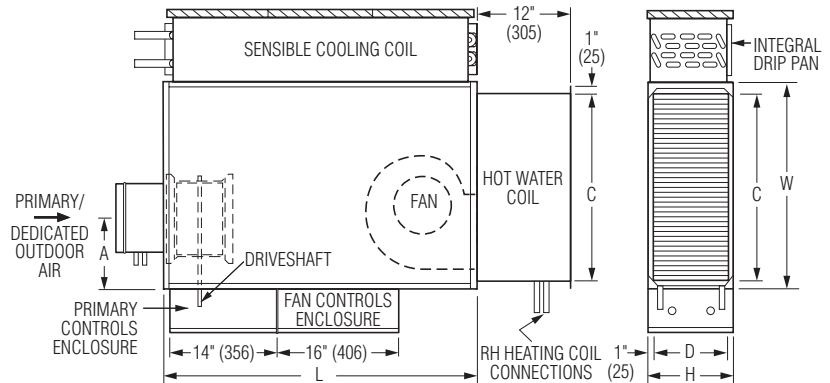

Unit Size 35 (Low Profile)

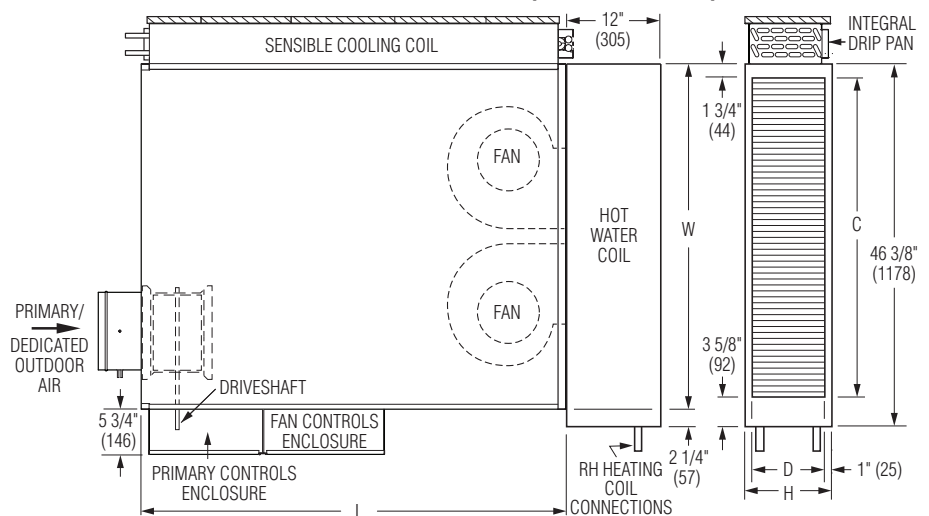

Unit Sizes 40, 50 & 55

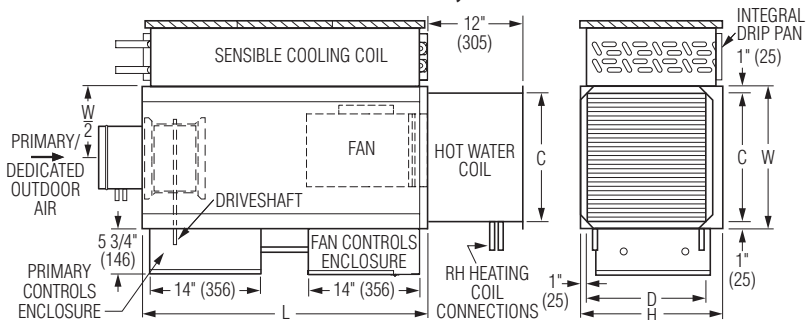

Dimensional Data

Unit Size	W	H	L	Outlet Duct Size C x D
10	26 1/2 (673)	8 1/2 (216)	47 1/4 (1200)	24 x 7 1/2 (610 x 191)
30	26 1/2 (673)	11 (279)	40 1/4 (1022)	24 x 8 3/4 (610 x 222)
35	44 (1118)	11 (279)	54 (1372)	41 x 9 (1041 x 229)
40	18 (457)	18 (457)	36 (914)	16 x 15 (406 x 381)
50	26 (660)	18 (457)	41 (1041)	24 x 15 (610 x 381)
55	26 (660)	18 (457)	55 (1397)	24 x 15 (610 x 381)

Dimensions

Model Series 33SZ • FPCWTU (DOAS) • Series Flow • Unit Sizes 10 - 55

Electric Coil Section

Model 33SZE

Standard Features:

- Unique hinged heater design permits easy access, removal and replacement of heater element without disturbing ductwork.
- Coil installed on unit discharge.
- Insulated coil element wrapper.
- Automatic reset high limit cut-outs (one per element).
- Single point electrical connection for entire terminal unit.
- Magnetic contactors per stage.
- Class A 80/20 Ni/Cr wire.
- Electronic Fan Interlock Relay.
- Flanged outlet duct connection.
- Terminal unit with coil is ETL listed as on assembly.
- Controls mounted as standard on RH side as shown. Terminals ordered with L.H. controls (optional) are inverted and discharge duct hanging elevation will change.

Standard Supply Voltage (60 Hz):

- Single phase: 120, 208, 240 & 277V.
- Three phase: 208, 480 (4 wire wye) and 600V (dual point connection).

Options:

- SCR control.
- SCR control with discharge temperature control.
- Toggle disconnect switch (includes fan).
- Door interlock disconnect switch.
- Quiet contactors.
- Main line fusing.
- Dust tight construction.
- Manual Reset secondary thermal cut out.
- Positive Pressure airflow switch.

Unit Size 10 & 30 (Low Profile)

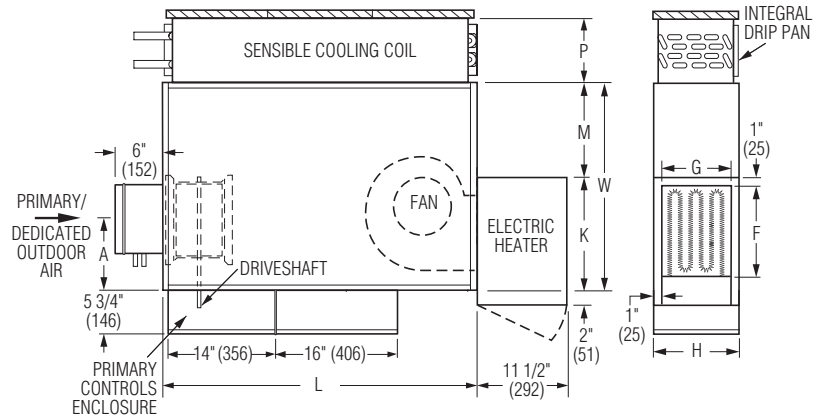

Unit Size 35 (Low Profile)

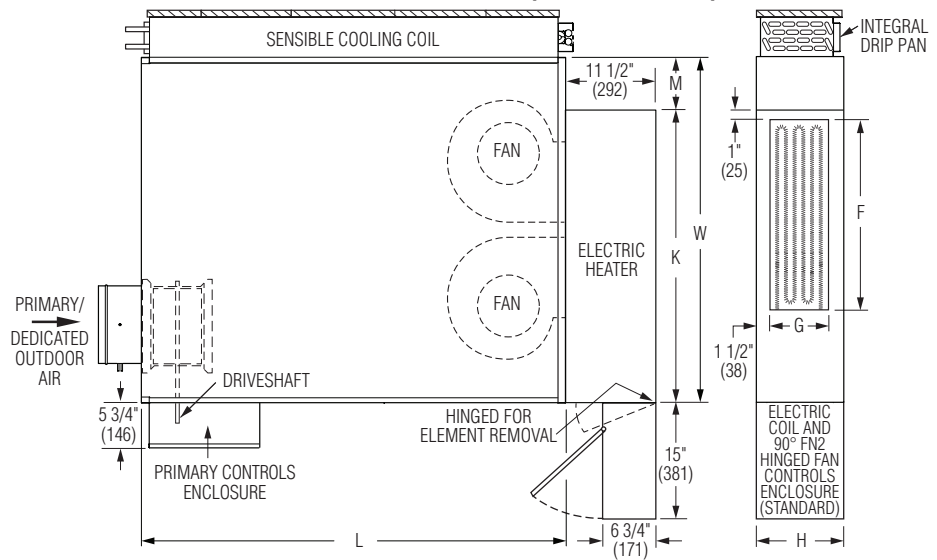

Unit Sizes 40, 50 & 55

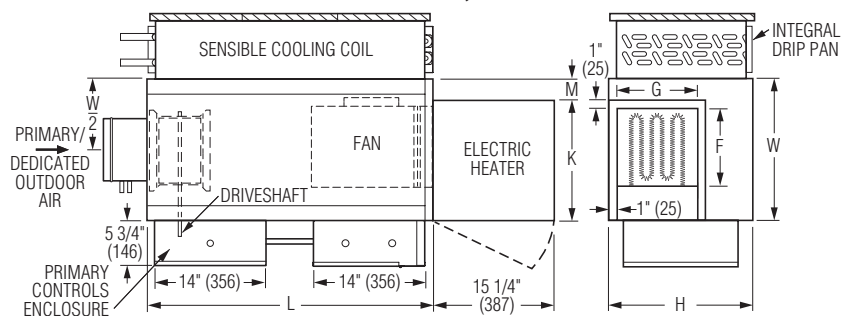

Dimensional Data

Unit Size	W	H	L	K	M	Outlet Duct Size F x G
10	26 1/2 (673)	8 1/2 (213)	47 1/4 (1200)	11 1/4 (286)	15 1/4 (387)	8 1/4 x 6 (210 x 152)
30	26 1/2 (673)	11 (279)	40 1/4 (1022)	15 3/8 (391)	11 1/8 (283)	12 3/8 x 9 (314 x 229)
35	44 (1118)	11 (279)	54 (1372)	52 3/8 (1330)	37 3/8 (949)	25 x 8 (635 x 203)
40	18 (457)	18 (457)	36 (914)	15 1/2 (394)	2 1/2 (64)	10 1/4 x 10 1/2 (260 x 267)
50	26 (660)	18 (457)	41 (1041)	22 (559)	4 (102)	14 1/4 x 11 3/4 (362 x 298)
55	26 (660)	18 (457)	55 (1397)	22 (559)	4 (102)	14 1/4 x 11 3/4 (362 x 298)

Dimensions

Model Series 33SZ • FPCWTU (DOAS) • Series Flow • Unit Sizes 10 and 30 (Low Profile)
With 90° Line Voltage Enclosure (FN2 Option)

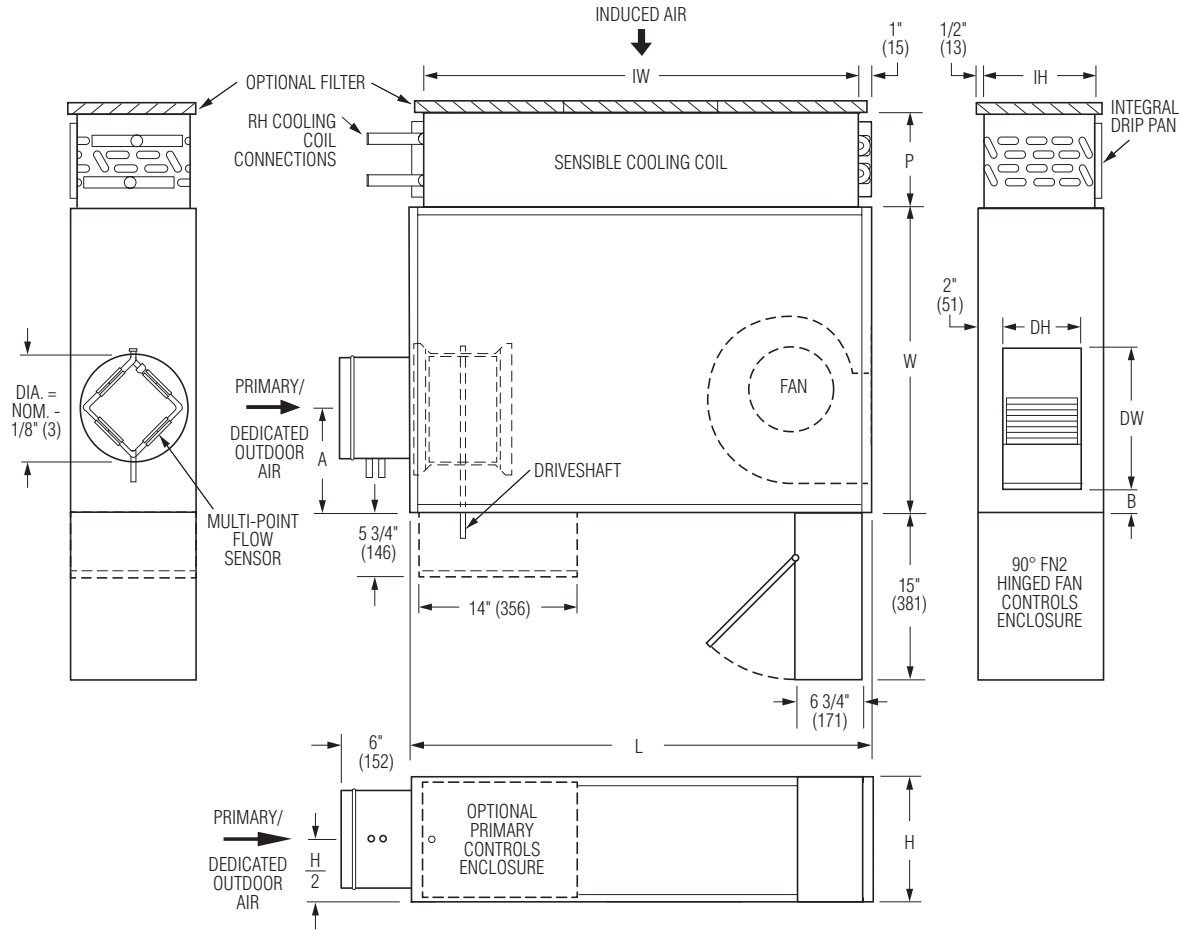

Dimensional Data

Unit Size	Inlet Size	W	H	L	A	B	Cooling Coil IW x IH	P	Outlet Discharge DW x DH	Filter Size
10	4, 6 (102, 152)	26 1/2 (673)	8 1/2 (216)	47 1/4 (1200)	5 1/8 (130)	2 (51)	43 x 7 1/2 (1092 x 191)	2 Row: 5 1/8 (130) 4 Row: 7 5/16 (186) 6 Row: 9 1/2 (241)	7 1/8 x 4 3/4 (181 x 121)	45 x 8 1/2 (1143 x 216)
30	4, 6, 8 (102, 152, 203)	26 1/2 (673)	11 (279)	40 1/4 (1022)	8 (203)	2 (51)	36 x 8 3/4 (914 x 222)	8 Row: 11 11/16 (297)	12 3/8 x 6 7/8 (314 x 175)	38 x 10 (965 x 254)

CW Coil O.D. Sweat Connections

Unit Size	No. of Row
10, 30	2, 4, 6 & 8
	7/8" (22)

Dimensions

Model Series 33SZ • FPCWTU (DOAS) • Series Flow • Unit Size 35 (Low Profile)
With 90° Line Voltage Enclosure (FN2 Option)

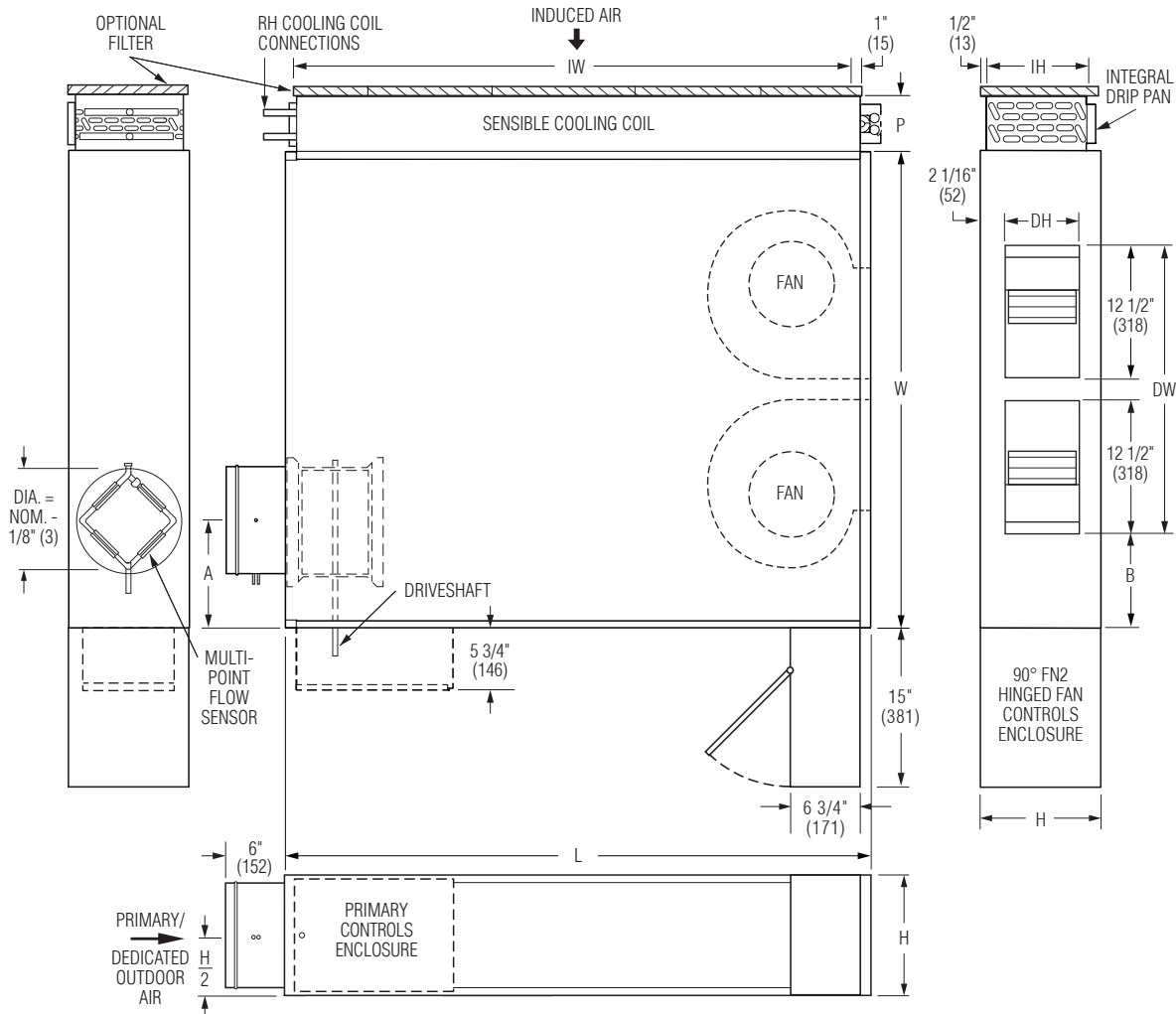

Dimensional Data

Unit Size	Inlet Size	W	H	L	A	B	Cooling Coil IW x IH	P	Outlet Discharge DW x DH	Filter Size
35	4, 5, 6, 8, 10 (102, 127, 152, 203, 254)	44 (1118)	11 (279)	54 (1372)	8 (203)	8 1/2 (216)	50 x 10 (1270 x 254)	2 Row: 5 1/8 (130) 4 Row: 7 5/16 (186) 6 Row: 9 1/2 (241) 8 Row: 11 1/2 (292)	27 x 6 7/8 (686 x 175)	2@ 26 x 11 (660 x 279)

CW Coil O.D. Sweat Connections

Unit Size	No. of Row
35	7/8" (22)

Dimensions

Model Series 33SZ • FPCWTU (DOAS) • Series Flow • Unit Sizes 40, 50 and 55
With 90° Line Voltage Enclosure (FN2 Option)

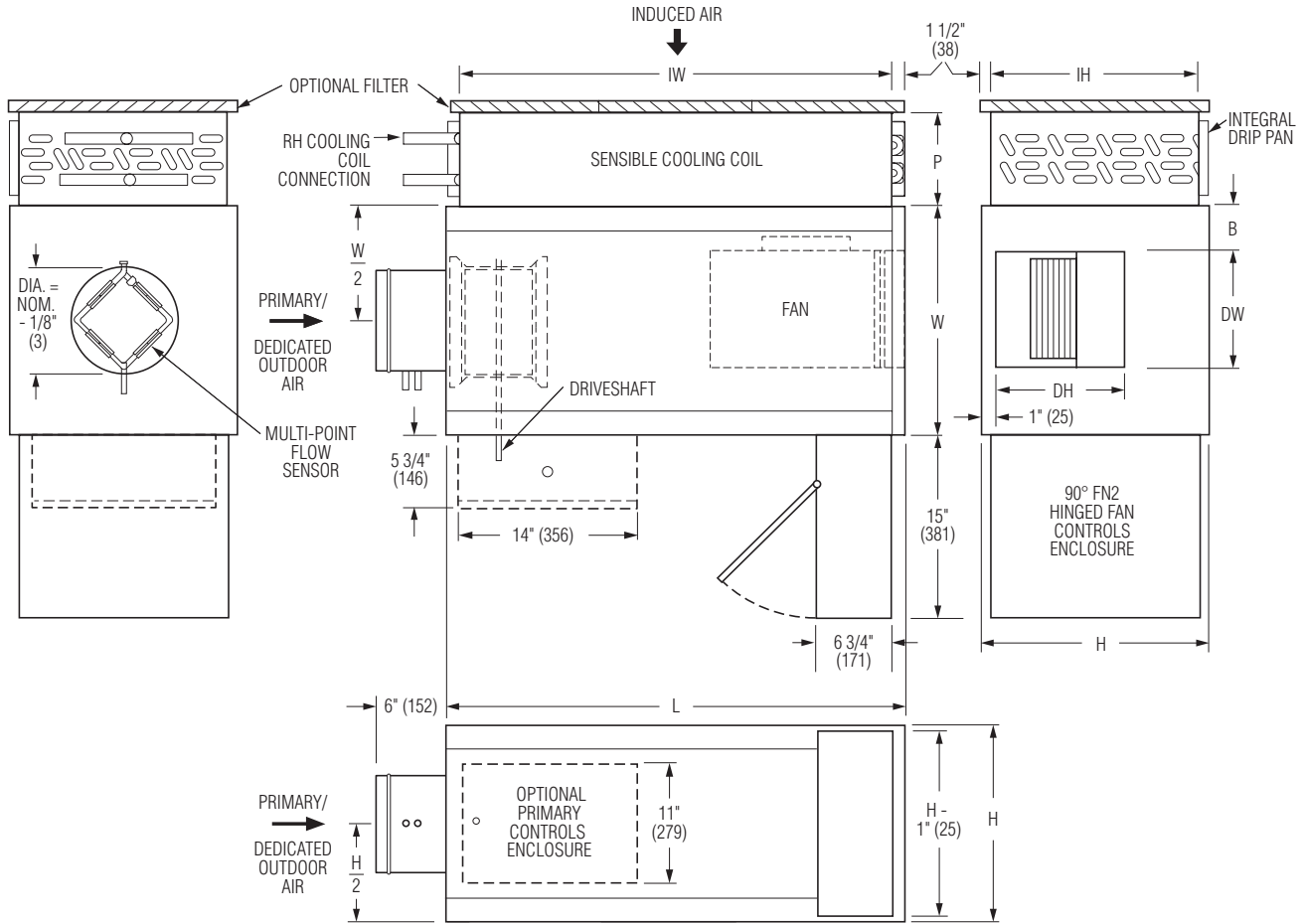

Dimensional Data

Unit Size	Inlet Size	W	H	L	B	Cooling Coil IW x IH	P	Outlet Discharge DW x DH	Filter Size
40	4, 6, 8, 10 (102, 152, 203, 254)	18 (457)	18 (457)	36 (914)	3 1/2 (89)	31 x 15 (787 x 381)	2 Row: 5 1/8 (130)	9 1/8 x 10 1/4 (232 x 260)	33 x 16 (838 x 406)
							4 Row: 7 5/16 (186)		
50	4, 6, 8, 10, 12 (102, 152, 203, 254, 305)	26 (660)	18 (457)	41 (1041)	5 (127)	36 x 15 (914 x 381)	6 Row: 9 1/2 (241)	13 1/8 x 11 1/4 (333 x 286)	38 x 16 (965 x 406)
							8 Row: 11 1/2 (292)		
55	6, 8, 10, 12, 14 (152, 203, 254, 305, 355)	26 (660)	18 (457)	55 (1397)	5 (127)	50 x 15 (1270 x 381)	6 Row: 9 1/2 (241)	13 1/8 x 11 1/4 (333 x 286)	52 x 16 (1321 x 406)
							8 Row: 11 1/2 (292)		

CW Coil O.D. Sweat Connections

Unit Size	No. of Row
	2, 4, 6 & 8
40, 50, 55	7/8" (22)

Dimensions

Model Series 33SZ • Unit Sizes 10 - 55
FPCWTU (DOAS) • Series Flow
With 90° Line Voltage Enclosure
(FN2 Option)

Hot Water Coil Section

Model 33SZW

Available in one or two row. Coil section installed on unit discharge. Right hand coil connection looking in direction of airflow standard (shown). Left hand is optional.

Standard Features:

- Coil section installed on unit discharge.
- 1/2" (13) copper tubes.
- Aluminum ripple fins @10 FPI.
- Sweat Connections:
 - Sizes 10 & 30:
 - 1 Row: 1/2" (13)
 - 2 Row: 5/8" (16)
 - Size 35:
 - 1 Row: 1/2" (13)
 - 2 Row: 7/8" (22)
 - Sizes 40, 50 & 55
 - 1 Row: 7/8" (22)
 - 2 Row: 7/8" (22)
- Flanged outlet duct connection.

Coil Rows:

- 1-Row
- 2-Row

Coil Hand Connections:

- (Looking in direction of airflow).
- Right Hand (illustrated). (Standard.)
- Left Hand. (Optional.)

Heating coil, sensible cooling coil and controls enclosure orientation must all be specified separately.

Unit Size 10 & 30 (Low Profile)

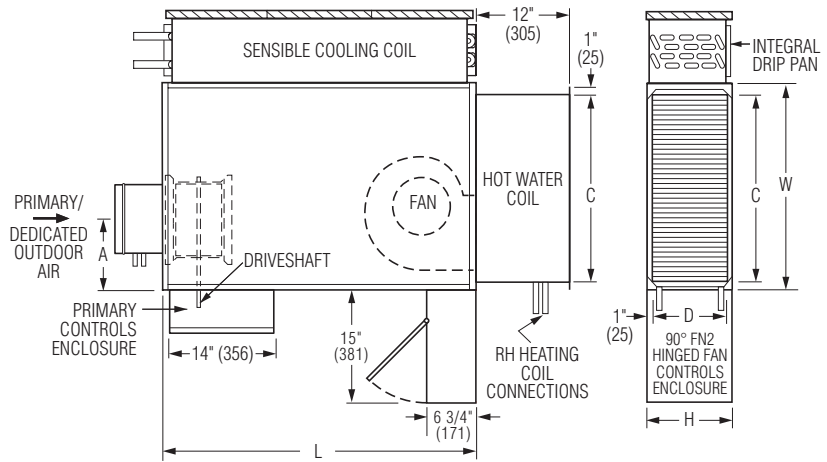

Unit Size 35 (Low Profile)

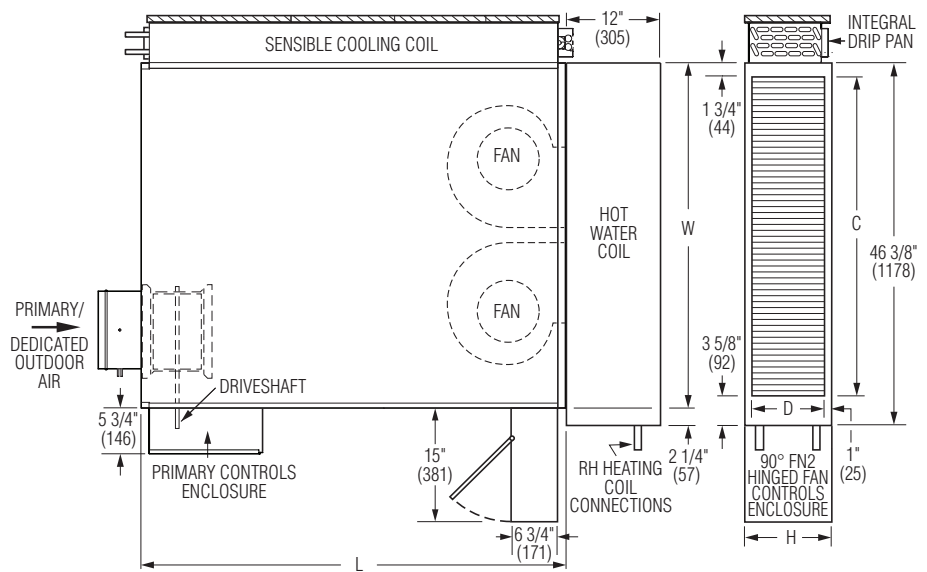

Unit Sizes 40, 50 & 55

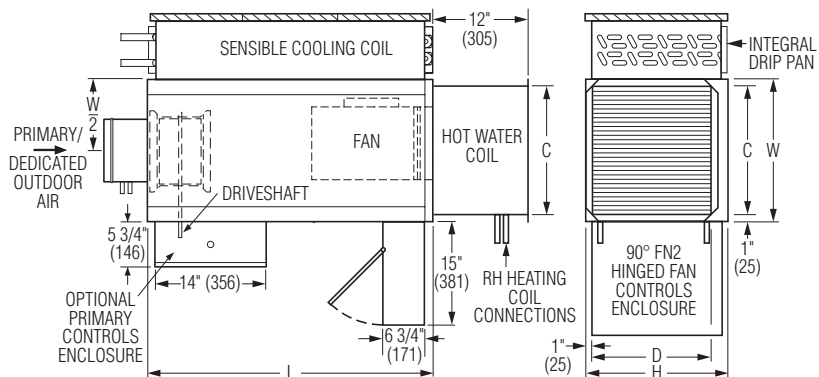

Dimensional Data

Unit Size	W	H	L	Outlet Duct Size C x D
10	26 1/2 (673)	8 1/2 (216)	47 1/4 (1200)	24 x 7 1/2 (610 x 191)
30	26 1/2 (673)	11 (279)	40 1/4 (1022)	24 x 8 3/4 (610 x 222)
35	44 (1118)	11 (279)	54 (1372)	41 x 9 (1041 x 229)
40	18 (457)	18 (457)	36 (914)	16 x 15 (406 x 381)
50	26 (660)	18 (457)	41 (1041)	24 x 15 (610 x 381)
55	26 (660)	18 (457)	55 (1397)	24 x 15 (610 x 381)

Dimensions

Model Series 33SZ • Unit Sizes 10 - 55

FPCWTU (DOAS) • Series Flow With 90° Line Voltage Enclosure (FN2 Option)

Electric Coil Section

Model 33SZE

Standard Features:

- Unique hinged heater design permits easy access, removal and replacement of heater element without disturbing ductwork.
- Coil installed on unit discharge.
- Insulated coil element wrapper.
- Automatic reset high limit cut-outs (one per element).
- Single point electrical connection for entire terminal unit.
- Magnetic contactors per stage.
- Class A 80/20 Ni/Cr wire.
- Electronic Fan Interlock Relay.
- Flanged outlet duct connection.
- Terminal unit with coil is ETL listed as on assembly.
- Controls mounted as standard on RH side as shown. Terminals ordered with L.H. controls (optional) are inverted and discharge duct hanging elevation will change.

Standard Supply Voltage (60 Hz):

- Single phase: 120, 208, 240 & 277V.
- Three phase: 208, 480 (4 wire wye) and 600V (dual point connection).

Options:

- SCR control.
- SCR control with discharge temperature control.
- Toggle disconnect switch (includes fan).
- Door interlock disconnect switch.
- Quiet contactors.
- Main line fusing.
- Dust tight construction.
- Manual Reset secondary thermal cut out.
- Positive Pressure airflow switch.

Unit Size 10 & 30 (Low Profile)

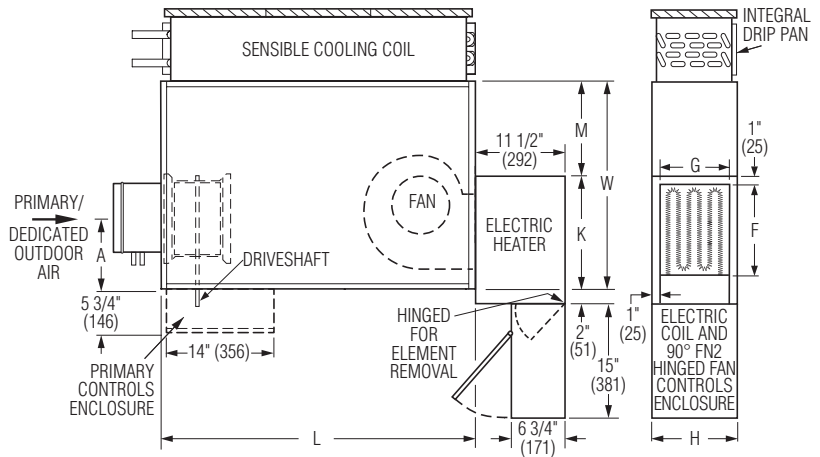

Unit Size 35 (Low Profile)

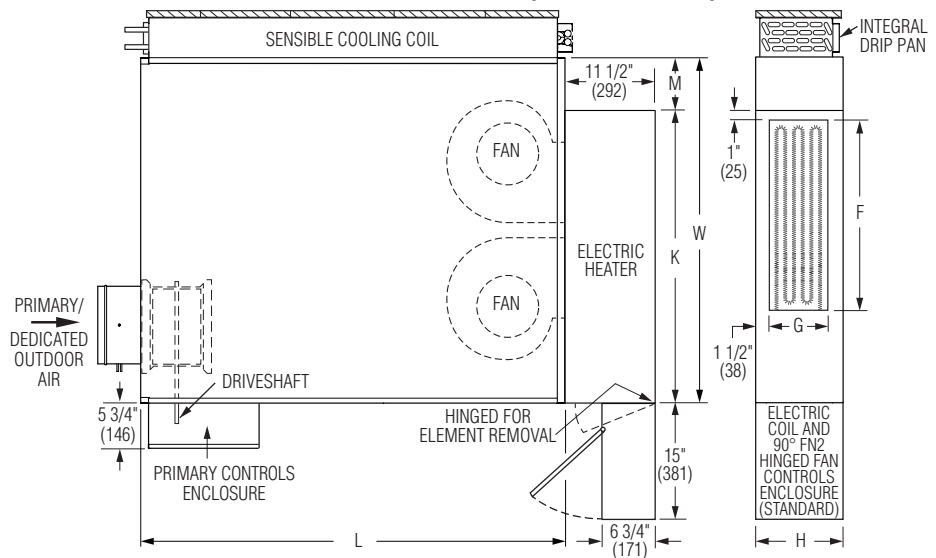

Unit Sizes 40, 50 & 55

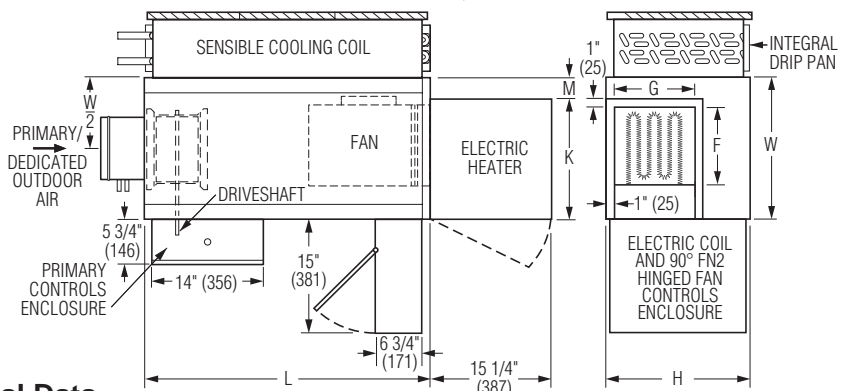

Dimensional Data

Unit Size	W	H	L	K	M	Outlet Duct Size F x G
10	26 1/2 (673)	8 1/2 (213)	47 1/4 (1200)	11 1/4 (286)	15 1/4 (387)	8 1/4 x 6 (210 x 152)
30	26 1/2 (673)	11 (279)	40 1/4 (1022)	15 3/8 (391)	11 1/8 (283)	12 3/8 x 9 (314 x 229)
35	44 (1118)	11 (279)	54 (1372)	52 3/8 (1330)	37 3/8 (949)	25 x 8 (635 x 203)
40	18 (457)	18 (457)	36 (914)	15 1/2 (394)	2 1/2 (64)	10 1/4 x 10 1/2 (260 x 267)
50	26 (660)	18 (457)	41 (1041)	22 (559)	4 (102)	14 1/4 x 11 3/4 (362 x 298)
55	26 (660)	18 (457)	55 (1397)	22 (559)	4 (102)	14 1/4 x 11 3/4 (362 x 298)

Dimensions

Model Series 33SZ • Accessories

Universal Ducted Return Filter Rack

- The DRFR (Ducted Return Filter Rack) is an optional accessory for Model Series 33SZ.
- The accessory is required for ducted inlet applications where a filter is also required and ease of accessibility is required.

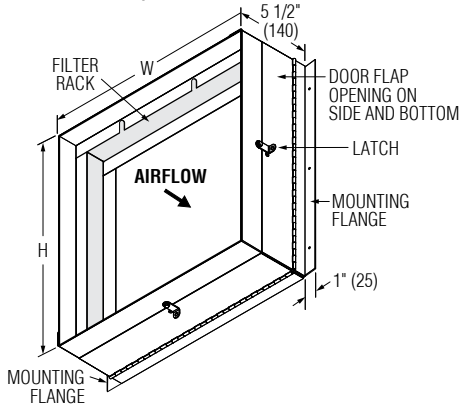

- The Ducted Filter Connection features a filter rack, which accommodates a 1" (25) standard or 2" (51) optional filter.
- Factory mounted on the induced air inlet of the draw through water coil section.
- A piano-hinged door flap with latch on the side and bottom of the unit accessory allows for easy removal and replacement of the filter.
- The accessory is provided with a nominally sized duct connection collar.

Dimensional Data

Unit Size	Inlet Size W x H	Filter Size W x H
10	43 x 7 1/2 (1092 x 191)	45 x 8 1/2 (1143 x 216)
30	36 x 8 3/4 (914 x 222)	38 x 10 (965 x 254)
35	50 x 10 (1270 x 254)	2 @ 26 x 11 (660 x 279)
40	31 x 15 (787 x 381)	33 x 16 (838 x 406)
50	36 x 15 (914 x 381)	38 x 16 (965 x 406)
55	50 x 15 (1270 x 381)	52 x 16 (1321 x 406)

Induced Air Dissipative Elbow Silencer

- The DSIE (Induced Air Dissipative Elbow Silencer) is an optional induced air inlet accessory for Model Series 33SZ and is shipped loose for field attachment.
- The compact patent pending elbow design provides maximum acoustic attenuation by reducing radiated sound power levels

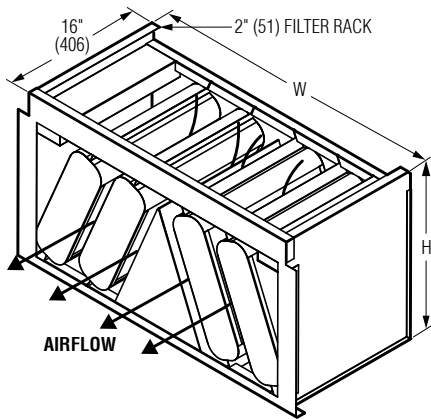

by an average of 3-5 NC.

- Silencer casing is constructed with 22 ga. (0.86) coated steel.
- Perforated angled baffles are 13% free area, 22 ga. (0.86) galvanized steel construction. Baffles are filled with fiberglass acoustic media.
- The silencer incorporates a slider-in-filter rack to accommodate a 1" (25) or 2" (51) filter.
- Silencer may be installed in one of two orientations with top entry or bottom entry induced air.

Dimensional Data

Unit Size	W	H	Filter Size
10	45 1/16 (1145)	10 11/16 (271)	20 x 16 (508 x 406)
30	38 1/16 (967)	11 15/16 (303)	38 x 16 (965 x 406)
35	52 3/16 (1326)	13 1/8 (334)	2@ 26 x 16 (1321 x 406)
40	33 1/4 (844)	18 15/16 (480)	33 x 16 (838 x 406)
50	36 3/8 (923)	19 15/16 (480)	35 x 16 (889 x 406)
55	52 1/8 (1324)	20 15/16 (480)	2@ 26 x 16 (1321 x 406)

Induced Air Dissipative Silencer

- The DSIF (Induced Air Dissipative Silencer) is an optional induced air inlet accessory and is shipped loose for field attachment.

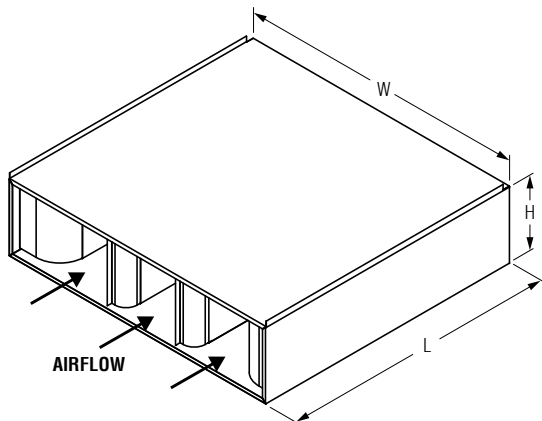

- DSIM Mylar/Spacer is an option for IAQ applications.
- The 36" (914) long dissipative silencer provides maximum acoustic attenuation by reducing radiated sound power levels by an average of 5 NC.
- Silencer casing is constructed with 22 ga. (0.86) coated steel.
- Perforated baffles are 13% free area, 22 ga. (0.86) galvanized steel construction. Baffles are filled with fiberglass acoustic media.

Dimensional Data

Unit Size	L	W	H
10	36 (914)	45 (1143)	8 5/8 (219)
30	36 (914)	38 (965)	9 7/8 (251)
35	36 (914)	52 (1321)	11 1/8 (283)
40	36 (914)	33 (838)	16 1/2 (419)
50	36 (914)	38 (965)	16 1/2 (419)
55	36 (914)	52 (1321)	16 1/2 (419)

FAN POWERED TERMINAL UNITS



Performance Data

ECM Motor Fan Curves – Airflow vs. Downstream Static Pressure

33SZ Series • FPCWTU (DOAS)

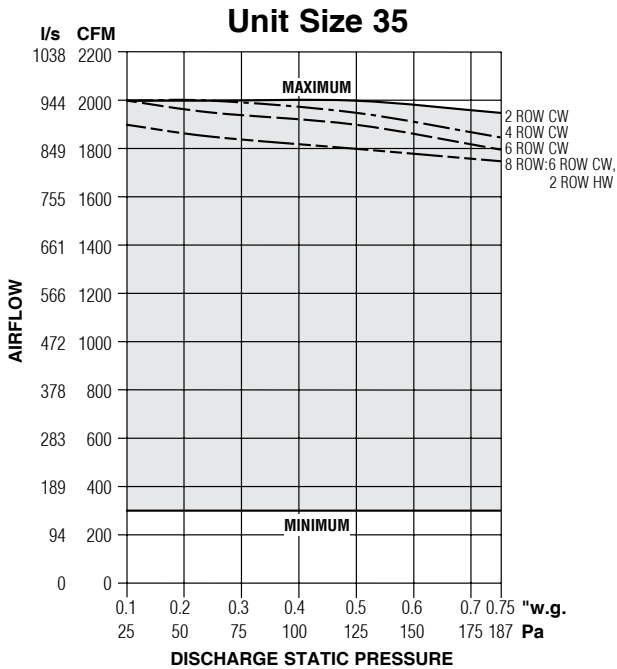
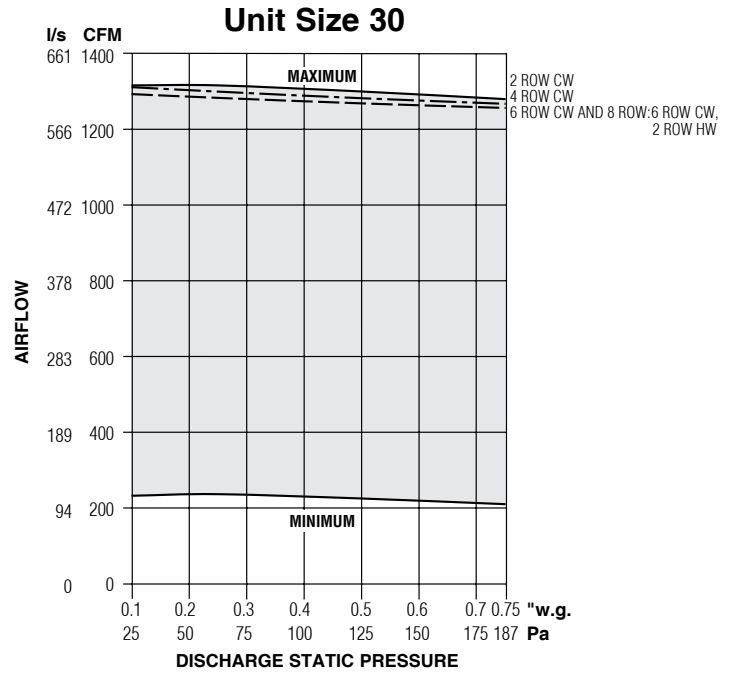
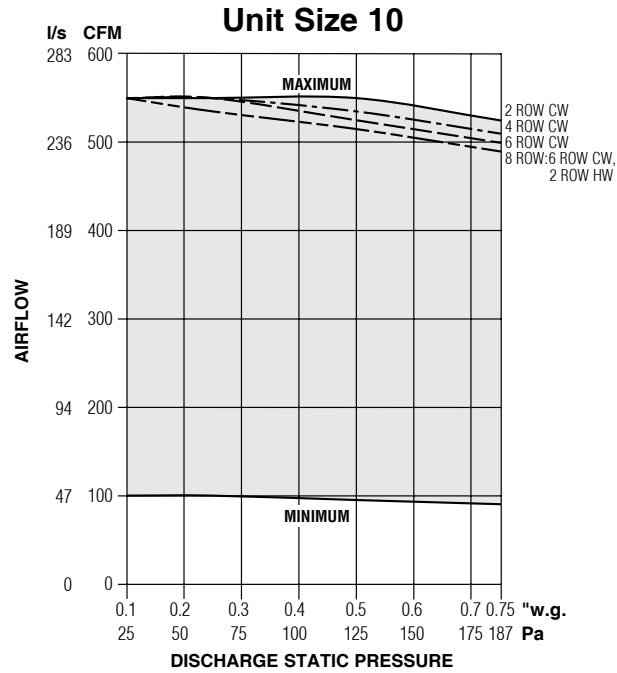

Electrical Data

Unit Size	EPIC ECM Motor FLA				
	Motor HP	120V	208V	240V	277V
10	*	2.2	1.6	1.5	1.5
30	*	7.5	5.0	5.0	4.9
35	*	9.4	6.3	6.1	5.8

* The ECM is a variable horsepower motor.
 Refer to Selectworks schedule for actual power consumption.
 FLA = Full load amperage.
 All motors are single phase/60 Hz.

NOTES:

- The ECM is pressure independent and constant volume in operation at factory or field set point within the shaded area. When the setpoint is on or below the respective maximum curve, airflow does not vary with changing static pressure conditions. The motor compensates for any changes in external static pressure or induced air conditions such as filter loading.

- Fan curves shown are applicable to 120, 208, 240 and 277 volt, single phase ECM's. ECM's, although DC in operation, include a built-in AC/DC converter.
- Minimum operation within the dark shaded area is not predictable.

Performance Data

ECM Motor Fan Curves – Airflow vs. Downstream Static Pressure

33SZ Series • FPCWTU (DOAS)

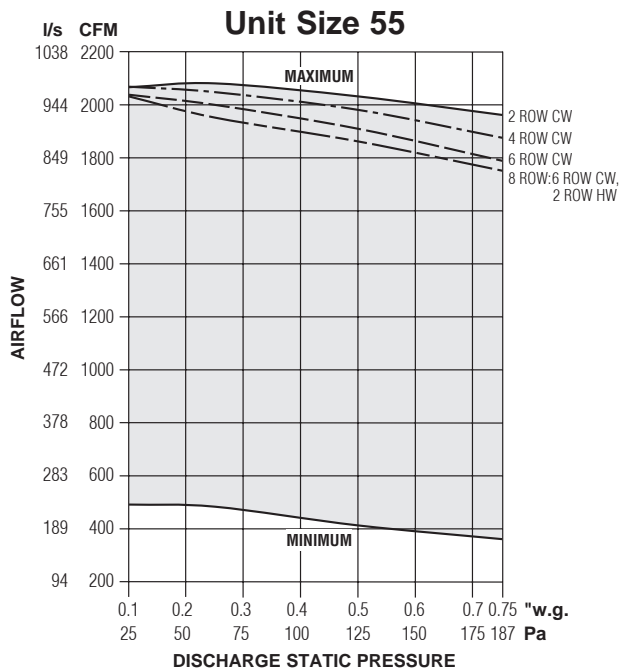
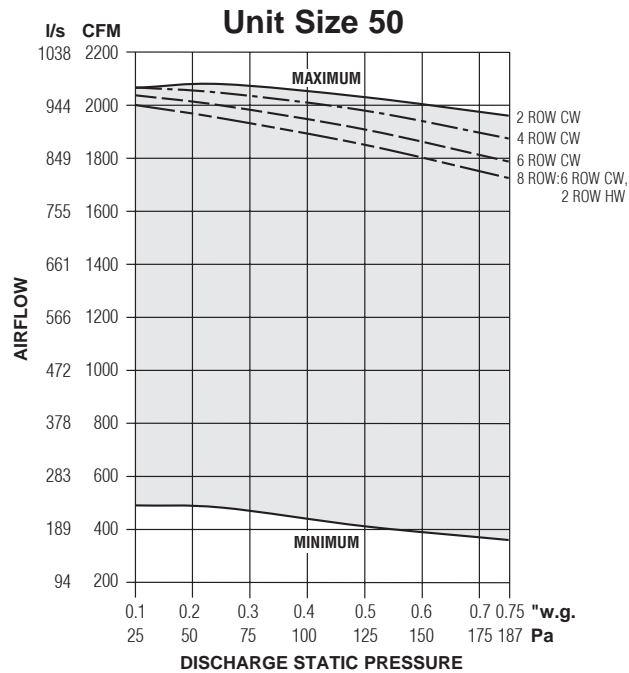
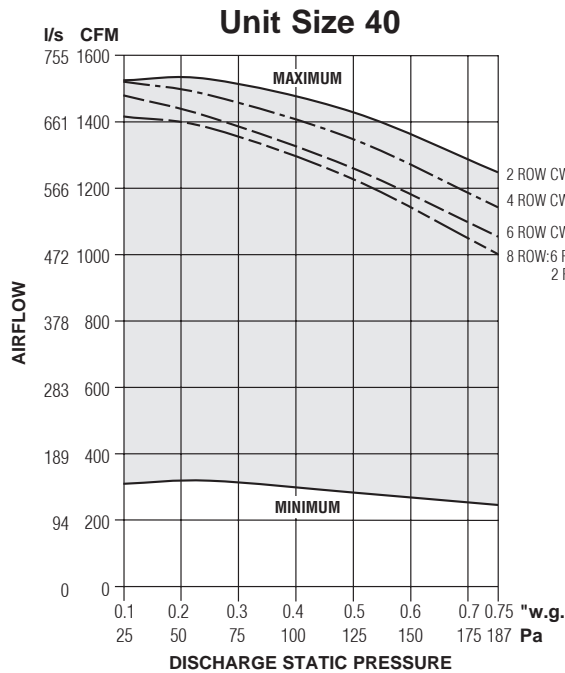

Electrical Data

Unit Size	EPIC ECM Motor FLA				
	Motor HP	120V	208V	240V	277V
40	*	6.5	4.3	4.2	4.2
50	*	10.5	6.8	6.2	6.0
55	*	9.5	6.4	6.2	6.0

* The ECM is a variable horsepower motor. Refer to Selectworks schedule for actual power consumption. FLA = Full load amperage. All motors are single phase/60 Hz.

NOTES:

- The ECM is pressure independent and constant volume in operation at factory or field set point within the shaded area. When the setpoint is on or below the respective maximum curve, airflow does not vary with changing static pressure conditions. The motor compensates for any changes in external static pressure or induced air conditions such as filter loading.

- Fan curves shown are applicable to 120, 208, 240 and 277 volt, single phase ECM's. ECM's, although DC in operation, include a built-in AC/DC converter.
- Minimum operation within the dark shaded area is not predictable.



Performance Data • NC Level Application Guide

Model Series 33SZ • Series Flow • FPCWTU (DOAS)

Unit Size	Inlet Size	Primary Airflow		Fan Airflow		Min. inlet ΔPs		Fan and 100% Primary Air-Sound Power Octave Bands @ Inlet pressure (ΔPs) shown									
		cfm	l/s	cfm	l/s	"w.g.	Pa	DISCHARGE					RADIATED				
								Fan Only	Minimum ΔPs	0.5" w.g. (125Pa)	1.0" w.g. (250Pa)	1.5" w.g. (375Pa)	Fan Only	Minimum ΔPs	0.5" w.g. (125Pa)	1.0" w.g. (250Pa)	1.5" w.g. (375Pa)
10	4	500	236	500	236	0.20	50	21	21	25	30	32	30	36	40	44	47
		350	165	400	189	0.07	17	-	-	23	28	30	27	33	38	42	45
		200	95	300	142	0.05	12	-	-	24	29	31	23	31	36	39	42
	6	150	71	200	95	0.03	7	-	-	20	25	27	-	27	33	36	38
		30	14	100	47	0.02	5	-	-	-	-	20	-	-	28	31	33
		500	236	500	236	0.20	50	21	24	28	32	35	30	33	37	42	45
30	4	225	106	1250	590	0.42	104	38	37	37	38	38	43	40	41	41	
		150	71	1000	472	0.15	37	34	31	31	31	33	38	37	37	37	37
		150	71	800	378	0.20	50	26	28	26	28	28	35	34	34	34	34
	6	90	42	500	236	0.06	15	-	-	-	-	-	26	26	26	26	28
		90	42	250	118	0.10	25	-	-	-	-	-	22	23	23	23	24
		550	260	1250	590	0.12	30	38	37	37	37	38	43	40	40	41	41
35	4	400	189	1000	472	0.06	15	34	31	30	30	31	38	37	37	37	37
		400	189	800	378	0.10	25	26	26	25	25	26	35	33	34	34	35
		235	111	500	236	0.03	6	-	-	-	-	-	26	26	28	30	32
	6	190	90	250	118	0.03	7	-	-	-	-	-	22	23	23	25	28
		1100	519	1250	590	0.09	22	38	37	37	37	37	43	41	41	41	43
		700	330	1000	472	0.01	2	34	31	30	30	30	38	37	37	37	38
40	4	415	196	800	378	0.01	2	26	26	25	25	25	35	33	34	34	35
		250	118	500	236	0.01	2	-	-	-	-	-	26	26	26	28	29
		190	90	250	118	0.01	2	-	-	-	-	-	23	22	23	24	26
	5	225	106	2000	945	0.97	241	45	42	42	42	42	47	46	46	45	46
		150	71	1600	756	0.40	99	40	38	38	38	38	42	40	41	41	41
		150	71	1200	567	0.37	93	34	32	32	32	32	37	37	37	37	38
40	5	90	43	800	378	0.12	31	26	24	24	24	24	32	32	32	33	33
		90	43	400	189	0.12	29	-	-	-	-	-	23	24	24	25	25
		400	189	2000	945	0.37	91	41	39	39	39	39	47	43	44	44	44
	6	300	142	1600	756	0.17	42	40	38	38	38	38	42	38	39	39	39
		200	95	1200	567	0.06	16	34	32	32	32	32	37	35	35	35	35
		150	71	800	378	0.03	8	26	24	24	24	24	32	29	30	31	31
40	6	100	47	400	189	0.01	3	-	-	-	-	-	23	22	22	22	23
		550	945	2000	945	0.25	63	41	39	39	39	39	47	47	48	48	48
		400	756	1600	756	0.11	27	36	34	34	34	34	42	42	43	43	43
	8	400	567	1200	567	0.09	22	31	28	28	28	28	37	38	38	38	38
		235	378	800	378	0.03	6	26	24	24	24	24	32	33	33	33	33
		235	189	400	189	0.02	5	-	-	-	-	-	23	25	25	25	25
40	8	1100	520	2000	945	0.02	6	38	36	36	36	36	47	41	44	45	45
		700	331	1600	756	0.01	2	36	34	34	34	34	42	38	41	41	41
		700	331	1200	567	0.01	2	31	28	28	29	29	37	35	36	37	37
	10	415	196	800	378	0.00	1	22	20	20	20	20	32	30	32	32	32
		250	118	400	189	0.00	0	-	-	-	-	-	23	22	24	24	24
		1840	870	2000	945	0.54	135	38	36	36	36	36	47	47	47	47	48
40	4	1100	520	1600	756	0.19	48	34	32	32	32	42	41	42	43	43	43
		660	312	1200	567	0.07	17	31	28	28	29	29	37	37	37	37	37
		410	194	800	378	0.03	7	22	20	20	20	20	32	31	32	32	33
	6	375	177	400	189	0.02	6	-	-	-	-	-	23	24	24	24	24
		225	106	1500	708	0.56	139	31	35	-	36	36	44	43	-	43	44
		150	71	1200	566	0.21	52	27	26	28	28	28	39	40	41	41	41
40	6	150	71	900	425	0.26	65	-	21	23	24	24	33	34	35	35	36
		90	42	600	283	0.08	20	-	-	-	-	-	31	33	34	33	32
		90	42	300	142	0.10	25	-	-	-	-	-	26	30	30	30	31
	8	550	260	1500	708	0.31	77	31	31	33	34	35	44	41	41	43	44
		400	189	1200	566	0.07	17	27	26	27	27	26	39	38	38	39	39
		400	189	900	425	0.09	22	-	20	21	21	23	33	32	33	34	35
40	10	235	111	600	283	0.03	7	-	-	-	-	20	31	29	29	29	29
		145	68	300	142	0.02	5	-	-	-	-	-	26	24	25	25	26
		1100	519	1500	708	0.09	22	31	33	33	33	34	43	43	44	44	44
	10	700	330	1200	566	0.02	5	27	27	28	29	30	38	38	38	39	40
		415	196	900	425	0.01	2	20	21	21	23	24	34	33	34	34	35
		290	137	600	283	0.01	2	-	-	-	-	-	29	28	29	30	31
40	10	175	83	300	142	0.01	2	-	-	-	-	25	25	25	25	26	
		1400	661	1500	708	0.02	5	32	31	33	34	34	43	41	43	44	45
		660	311	1200	566	0.01	2	30	29	30	30	30	38	37	38	38	39
	10	445	210	900	425	0.01	2	20	22	21	22	23	33	32	33	34	34
		335	158	600	283	0.01	2	-	-	-	20	21	29	29	29	29	29
		260	123	300	142	0.01	2	-	-	-	-	-	24	24	24	25	28

Performance Notes: 1. NC Levels are calculated based on procedures as outlined on page C160.

2. Dash (-) in space indicates a NC less than 20.

Performance Data • NC Level Application Guide

Model Series 33SZ • Series Flow • FPCWTU (DOAS)

Unit Size	Inlet Size	Primary Airflow		Fan Airflow		Min. inlet ΔPs		Fan and 100% Primary Air–Sound Power Octave Bands @ Inlet pressure (ΔPs) shown									
		cfm	l/s	cfm	l/s	"w.g.	Pa	DISCHARGE					RADIATED				
								Fan Only	Minimum ΔPs	0.5" w.g. (125Pa)	1.0" w.g. (250Pa)	1.5" w.g. (375Pa)	Fan Only	Minimum ΔPs	0.5" w.g. (125Pa)	1.0" w.g. (250Pa)	1.5" w.g. (375Pa)
50	4	225	106	2000	944	0.51	127	36	39	-	38	38	40	42	-	42	43
		150	71	1600	755	0.18	45	31	31	33	34	34	36	36	36	37	38
		150	71	1200	566	0.24	60	26	26	27	27	27	31	32	31	32	33
		90	42	800	378	0.08	20	22	22	23	24	24	25	25	24	25	27
		90	42	500	236	0.10	25	-	20	-	-	-	23	23	23	24	25
	6	550	260	2000	944	0.12	30	35	36	35	36	36	40	41	42	42	43
		400	189	1600	755	0.04	10	30	29	30	31	32	36	36	36	38	39
		400	189	1200	566	0.09	22	24	24	24	25	25	30	32	32	33	35
		235	111	800	378	0.02	5	22	24	26	28	29	25	25	25	27	29
		235	111	500	236	0.04	10	-	-	-	-	-	22	23	24	26	28
	8	1100	519	2000	944	0.12	30	34	33	34	34	35	40	42	43	43	43
		700	330	1600	755	0.02	5	30	28	29	31	32	36	36	37	39	40
		700	330	1200	566	0.06	15	30	28	28	29	30	31	32	33	35	37
		415	196	800	378	0.01	2	-	-	-	-	-	25	25	26	29	32
		250	118	500	236	0.01	2	-	-	-	-	20	23	23	24	26	28
	10	1840	868	2000	944	0.25	62	34	34	34	35	36	41	42	44	45	46
		1100	519	1600	755	0.08	20	28	27	28	29	31	36	36	37	39	40
		660	311	1200	566	0.01	2	23	22	23	24	25	31	31	31	33	35
		410	193	800	378	0.01	2	-	-	-	-	-	25	25	26	27	29
		375	177	500	236	0.01	2	-	-	-	-	-	23	22	24	26	28
12	2000	944	2000	944	0.09	22	33	34	34	35	37	40	41	43	44	46	
	1600	755	1600	755	0.06	15	28	26	28	32	36	36	36	38	41	43	
	595	281	1200	566	0.01	2	22	21	22	23	25	31	31	31	32	34	
	445	210	800	378	0.01	2	-	-	-	-	-	25	25	25	27	30	
	395	186	500	236	0.01	2	-	-	-	-	-	22	22	24	27	29	
55	6	550	260	2000	944	0.01	2	37	37	37	37	38	41	47	46	47	48
		400	189	1600	755	0.00	1	33	31	33	33	34	38	41	44	45	45
		400	189	1200	566	0.01	2	28	29	29	30	30	34	40	40	41	41
		235	111	800	378	0.00	1	23	24	26	26	27	28	33	35	36	37
		235	111	500	236	0.01	2	-	-	-	20	21	22	30	30	31	31
	8	1100	520	2000	944	0.03	7	36	37	37	38	38	41	42	44	45	45
		700	331	1600	755	0.02	4	33	32	33	34	34	38	37	41	42	42
		700	331	1200	566	0.02	5	28	30	30	31	31	34	36	38	39	40
		415	196	800	378	0.01	3	20	21	23	23	23	28	29	33	34	35
		250	118	500	236	0.01	2	-	-	-	-	-	22	23	28	29	29
	10	1840	870	2000	944	0.08	19	36	38	38	39	39	41	43	44	45	45
		1100	520	1600	755	0.04	9	32	30	33	33	33	38	35	40	41	41
		660	312	1200	566	0.02	5	28	27	27	28	28	34	35	36	37	37
		410	194	800	378	0.01	3	20	-	20	21	21	28	26	31	32	32
		375	177	500	236	0.02	4	-	-	-	-	-	22	26	27	28	29
	12	2000	945	2000	944	0.09	22	36	36	36	37	37	41	32	42	43	43
		1600	756	1600	755	0.08	20	32	32	32	33	33	38	26	39	40	41
		900	425	1200	566	0.06	14	-	-	21	22	22	34	22	35	36	36
		445	210	800	378	0.02	6	-	-	-	-	-	28	20	29	30	31
		395	187	500	236	0.01	2	26	-	21	21	22	22	-	25	26	27
14	2000	945	2000	944	0.09	22	36	34	34	34	35	41	37	40	41	41	
	1600	756	1600	755	0.08	20	32	30	30	31	31	38	32	37	38	39	
	900	425	1200	566	0.06	14	-	-	-	-	-	34	30	33	34	34	
	445	210	800	378	0.02	6	-	-	-	-	-	28	22	27	28	28	
	395	187	500	236	0.01	2	26	-	-	-	-	22	21	23	24	25	

For full performance table notes, see page C35.

FAN POWERED TERMINAL UNITS



Performance Data • Discharge Sound Power Levels

Model Series 33SZ • Series Flow • FPCWTU (DOAS)

Unit Size	Inlet Size	Primary Airflow		Fan Airflow		Min. inlet ΔPs "w.g. Pa	Fan and 100% Primary Air-Sound Power Octave Bands @ Inlet pressure (ΔPs) shown																																		
							Fan Only							Minimum ΔPs							0.5" w.g. Inlet Static							1.0" w.g. Inlet Static							1.5" w.g. Inlet Static						
							2	3	4	5	6	7	2	3	4	5	6	7	2	3	4	5	6	7	2	3	4	5	6	7	2	3	4	5	6	7					
10	4	500	236	500	236	0.20	50	68	62	59	53	43	33	68	63	59	52	42	32	71	66	62	55	45	36	75	70	64	58	48	40	77	72	66	60	50	42				
		350	165	400	189	0.07	17	65	58	55	49	39	27	65	60	56	49	39	29	70	65	60	55	45	36	73	68	63	58	48	39	75	70	65	60	50	42				
		200	95	300	142	0.05	12	59	53	50	44	34	22	62	57	54	48	38	29	67	62	58	55	46	36	71	65	61	58	49	40	73	67	63	59	50	42				
		150	71	200	95	0.03	7	55	49	47	42	31	14	59	54	51	44	34	25	64	59	56	52	43	34	68	62	59	55	46	37	70	64	60	57	47	39				
		30	14	100	47	0.02	5	50	46	43	38	26	13	53	47	46	44	36	26	59	53	52	53	46	36	62	56	55	56	49	40	64	58	56	58	51	42				
	6	500	236	500	236	0.20	50	68	62	59	53	43	33	70	65	61	54	44	34	73	68	64	57	47	38	77	72	66	60	50	42	79	74	68	62	52	44				
		350	165	400	189	0.07	17	65	58	55	49	39	27	67	62	58	51	41	31	72	67	62	57	47	38	75	70	65	60	50	41	77	72	67	62	52	44				
		200	95	300	142	0.05	12	59	53	50	44	34	22	64	59	56	50	40	31	69	64	60	57	48	38	73	67	63	60	51	42	75	69	65	61	52	44				
		150	71	200	95	0.03	7	55	49	47	42	31	14	61	56	53	46	36	27	66	61	58	54	45	36	70	64	61	57	48	39	72	66	62	59	49	41				
		30	14	100	47	0.02	5	50	46	43	38	26	13	55	49	48	46	38	28	61	55	54	55	48	38	64	58	57	58	51	42	66	60	58	60	53	44				
30	4	225	106	1250	590	0.42	104	79	78	71	72	71	69	80	77	72	72	71	69	79	77	71	72	71	69	78	78	71	72	71	69	78	78	71	72	71	69				
		150	71	1000	472	0.15	37	77	74	67	69	67	65	76	72	66	67	66	64	75	72	66	67	65	63	76	72	66	67	66	64	76	73	67	68	66	64				
		150	71	800	378	0.20	50	74	68	63	64	62	60	74	69	63	63	62	60	74	68	63	64	62	60	73	69	63	64	62	60	73	69	63	64	62	60				
		90	42	500	236	0.06	15	64	57	55	55	52	48	65	58	55	55	52	49	64	58	55	55	51	48	64	57	55	55	51	47	63	57	55	55	51	47				
		90	42	250	118	0.10	25	58	51	51	49	46	39	59	51	52	50	46	38	59	51	50	48	44	36	58	51	50	48	44	36	57	51	50	47	43	36				
	6	550	260	1250	590	0.12	30	79	78	71	72	71	69	80	77	72	72	71	69	79	77	71	72	71	69	79	77	71	72	71	69	79	78	71	72	71	69				
		400	189	1000	472	0.06	15	77	74	67	69	67	65	76	72	66	67	66	64	75	71	66	67	65	63	75	71	66	67	65	63	75	72	66	67	66	64				
		400	189	800	378	0.10	25	74	68	63	64	62	60	73	68	62	63	61	59	73	67	62	63	61	59	73	67	62	63	61	59	72	68	62	63	61	59				
		235	111	500	236	0.03	6	64	57	55	55	52	48	65	58	55	55	52	48	64	58	55	55	51	47	65	58	55	55	51	47	65	58	55	55	51	47				
		190	90	250	118	0.03	7	58	51	51	49	46	39	58	51	52	50	46	38	60	52	50	48	45	37	60	54	51	49	45	38	61	55	51	49	46	39				
8	1100	519	1250	590	0.09	22	79	78	71	72	71	69	80	77	72	72	71	69	79	77	71	72	71	69	79	77	71	72	71	69	79	77	71	72	71	69					
	700	330	1000	472	0.01	2	77	74	67	69	67	65	76	72	66	67	66	64	75	71	66	67	65	63	75	71	66	67	65	63	75	71	66	67	65	63					
	415	196	800	378	0.01	2	74	68	63	64	62	60	73	68	62	63	61	59	73	67	62	63	61	59	73	67	62	63	61	59	72	67	62	63	61	59					
	250	118	500	236	0.01	2	65	57	55	55	52	48	66	57	55	55	52	48	65	57	55	55	51	47	65	57	55	55	51	47	65	57	55	55	51	47					
	190	90	250	118	0.01	2	58	51	51	49	46	39	58	50	51	49	45	37	59	51	50	48	44	36	59	52	50	49	45	37	59	53	51	49	45	37					
35	4	225	83	2000	945	0.97	241	83	75	71	70	68	67	82	75	71	70	69	67	82	75	71	70	69	67	82	75	71	70	69	67	82	75	71	70	69	67				
		150	31	1600	945	0.40	99	80	72	68	67	65	63	78	71	68	67	65	62	78	72	68	67	65	62	78	72	68	67	65	62	78	72	68	67	65	62				
		150	83	1200	709	0.37	93	75	67	65	63	61	57	74	67	64	62	60	56	74	67	64	62	60	56	74	67	64	62	60	56	74	67	64	62	60	55				
		90	31	800	709	0.12	31	69	60	60	57	55	50	67	61	59	56	53	47	67	61	59	56	53	47	67	61	59	56	53	47	67	61	59	56	53	47				
		90	83	400	520	0.12	29	58	49	52	48	44	37	56	49	49	44	40	32	56	50	50	44	40	31	57	50	50	44	40	31	57	50	50	44	40	31				
	5	400	189	2000	945	0.37	91	83	75	71	70	68	67	82	74	70	70	68	66	82	74	70	70	68	66	82	74	70	70	68	66	82	74	70	70	68	66				
		300	142	1600	756	0.17	42	80	72	68	67	65	63	78	71	68	66	64	62	78	71	68	66	64	62	78	71	68	66	64	61	78	71	68	66	64	61				
		200	95	1200	567	0.06	16	75	67	65	63	61	57	74	67	64	62	60	55	74	67	64	62	60	55	74	67	64	62	60	55	74	67	64	62	60	55				
		150	71	800	378	0.03	8	69	60	60	57	55	50	67	60	59	55	52	47	67	60	59	55	52	47	67	61	59	55	52	47	67	61	59	55	52	46				
		100	47	400	189	0.01	3	58	49	52	48	44	37	56	50	49	44	40	31	56	50	49	44	40	31	57	50	49	44	40	31	57	50	49	44	40	31				
6	550	945	2000	945	0.25	63	83	75	71	70	68	67	82	74	70	70	68	66	82	74	70	70	68	66	82	74	70	70	68	66	82	74	70	70	68	66					
	400	756	1600	756	0.11	27	80	72	68	67	65	63	78	70	67	66	64	61	78	70	67	66	64	61	78	71	67	66	64	61	78	71	67	66	64	61					
	400	567	1200	567	0.09	22	75	67	65	63	61	57	74	66	63	61	59	55	74	66	63	61	59	55	74	66	63	61	59	55	74	66	63	61	59	55					
	235	378	800	378	0.03	6	69	60	60	57	55	50	67	60	58	55	52	46	67	60	58	55	52	46	67	60	58	55	52	46	67	60	58	55	52	46					
	235	189	400	189	0.02	5	58	49	52	48	44	37	57	49	49	43	39	31	57	49	49	43	39	31	57	49	49	43	39	31	57	49	49	43	39	31					
8	1100	520	2000	945	0.02	6	83	75	71	70	68	67	82	73	69	69	67	66	82	73	69	69	67	66	82	73	69	69	67	66	82	73	69	69	67	66					
	700	331	1600	756	0.01	2	80	72	68	67	65	63	78	70	67	66	63	61	78	70	67	66	63	61	78	70	67	66	63	61	78	70	67	66	63	61					
	415	196	800	378	0.01	2	75	67	65	63	61	57	74	65	63	61	58	55	74	65	63	61	58	55	74																

Performance Data • Discharge Sound Power Levels

Model Series 33SZ • Series Flow • FPCWTU (DOAS)

Unit Size	Inlet Size	Primary Airflow		Fan Airflow		Min. inlet ΔPs "w.g. Pa	Fan and 100% Primary Air-Sound Power Octave Bands @ Inlet pressure (ΔPs) shown																																																											
							Fan Only					Minimum ΔPs					0.5" w.g. Inlet Static					1.0" w.g. Inlet Static					1.5" w.g. Inlet Static																																							
							2	3	4	5	6	7	2	3	4	5	6	7	2	3	4	5	6	7	2	3	4	5	6	7	2	3	4	5	6	7																														
50	4	225	106	2000	944	0.51	127	77	74	72	74	71	70	79	75	72	75	71	71	-	-	-	-	-	-	78	75	72	75	71	71	78	76	72	75	71	71	78	76	72	75	71	71																							
		150	71	1600	755	0.18	45	72	70	68	68	66	64	73	69	69	68	65	64	74	70	69	69	66	65	75	71	69	69	66	66	75	72	69	70	66	67	69	65	63	63	60	59	67	60	58	56	52	48	67	59	58	55	52	48	62	55	55	53	45	40					
		150	71	1200	566	0.24	60	69	64	63	62	59	57	69	65	62	62	59	58	69	65	63	62	59	59	70	65	63	63	60	59	70	66	63	63	60	60	70	66	64	63	60	60	71	65	62	59	57	54	61	56	54	52	46	40	62	57	55	52	46	40					
		90	42	800	378	0.08	20	66	58	56	55	51	47	66	59	57	56	52	48	67	60	58	56	52	49	67	60	58	56	52	48	67	60	58	56	52	48	67	60	58	56	52	48	67	59	58	55	52	48	61	56	54	52	46	40	62	57	55	53	46	40					
		90	42	500	236	0.10	25	64	58	55	52	47	41	64	57	53	51	46	39	63	57	55	52	46	40	62	56	55	53	46	40	62	56	55	53	46	40	62	55	55	53	45	40	62	55	55	53	45	40	62	55	55	53	45	40	62	55	55	53	45	40	62	55	55	53	45
	6	550	260	2000	944	0.12	30	77	74	72	74	71	70	80	75	72	74	71	71	79	75	72	74	71	71	79	75	72	75	71	71	78	76	72	75	71	71	78	76	72	75	71	71	78	76	72	75	71	71	78	76	72	75	71	71	78	76	72	75	71	71					
		400	189	1600	755	0.04	10	72	70	68	68	65	64	73	70	68	68	65	64	75	70	69	69	66	65	75	71	69	69	66	66	76	72	69	70	66	67	76	72	69	70	66	67	76	72	69	70	66	67	76	72	69	70	66	67	76	72	69	70	66	67					
		400	189	1200	566	0.09	22	69	65	63	62	59	57	69	65	63	62	59	59	70	65	63	63	60	59	70	66	63	63	60	60	70	66	63	63	60	60	70	66	63	63	60	60	70	66	63	63	60	60	70	66	63	63	60	60	70	66	63	63	60	60					
		235	111	800	378	0.02	5	66	60	58	56	52	49	67	62	59	58	54	51	69	63	61	59	55	53	70	64	61	59	56	53	70	64	61	59	56	53	71	65	62	59	57	54	62	57	55	52	46	41	62	57	55	52	46	41											
		235	111	500	236	0.04	10	62	57	55	51	47	41	61	55	52	50	45	38	61	56	54	52	46	40	61	56	54	52	46	40	61	56	55	52	46	40	61	56	55	52	46	40	61	56	55	52	46	40	61	56	55	52	46	40											
	8	1100	519	2000	944	0.12	30	77	74	72	74	71	70	78	73	72	73	70	70	78	74	72	74	70	70	78	75	72	74	71	71	78	76	72	75	71	71	78	76	72	75	71	71	78	76	72	75	71	71	78	76	72	75	71	71											
		700	330	1600	755	0.02	5	73	70	68	68	66	64	72	68	67	67	64	63	74	70	68	68	65	64	75	71	69	69	66	65	75	72	69	69	66	66	75	72	69	69	66	66	75	72	69	69	66	66																	
		700	330	1200	566	0.06	15	74	70	66	66	63	60	71	68	64	64	61	60	72	69	65	65	62	60	72	69	65	65	62	61	72	69	65	65	62	61	72	70	66	65	62	61	72	70	66	65	62	61																	
		415	196	800	378	0.01	2	65	59	57	55	52	50	64	58	57	55	52	49	65	59	58	56	53	50	65	59	58	56	53	50	65	59	58	55	52	50	66	59	58	55	52	49	66	59	58	55	52	49																	
		250	118	500	236	0.01	2	64	59	56	53	49	45	63	58	54	52	48	43	63	58	56	54	49	44	64	58	56	54	49	44	64	58	56	54	49	44	64	58	56	54	49	44	64	58	56	54	49	44																	
	10	1840	868	2000	944	0.25	62	77	75	72	74	71	71	78	74	72	73	70	71	79	74	72	73	71	71	79	74	72	73	71	71	80	75	72	74	71	71	81	76	73	74	71	71	81	76	73	74	71	71																	
		1100	519	1600	755	0.08	20	73	70	68	68	65	65	72	68	67	67	64	64	74	69	68	67	65	65	75	71	68	68	66	65	75	72	69	69	66	66	75	72	69	69	66	66																							
		660	311	1200	566	0.01	2	69	64	62	61	58	57	68	63	61	61	58	56	69	64	62	61	59	57	70	65	62	62	59	58	71	66	63	62	59	58	71	66	63	62	59	58																							
		410	193	800	378	0.01	2	65	58	56	55	51	46	64	58	55	54	50	45	65	59	57	55	51	47	66	60	57	55	51	47	66	60	57	55	51	47	66	60	57	55	51	47																							
		375	177	500	236	0.01	2	64	58	55	52	47	41	62	56	53	50	45	39	62	57	55	52	46	41	63	58	55	52	47	41	63	58	55	52	47	41	64	58	55	52	47	42																							
	12	2000	944	2000	944	0.09	22	77	74	72	74	71	70	78	73	72	73	70	71	78	74	72	74	71	71	80	76	72	74	71	71	81	77	73	75	71	71	81	77	73	75	71	71																							
		1600	755	1600	755	0.06	15	73	70	68	68	65	64	71	67	67	67	64	63	75	70	69	68	66	65	77	73	70	70	67	67	80	76	72	72	68	69	80	76	72	72	68	69																							
		900	425	1200	566	0.01	2	69	64	63	61	58	57	67	63	61	61	58	56	69	64	63	62	59	58	70	66	64	63	60	60	72	67	65	64	61	61	72	67	65	64	61	61																							
		445	210	800	378	0.01	2	64	58	56	55	51	47	63	58	56	55	51	46	65	59	58	56	52	49	66	59	57	56	52	48	66	59	57	55	51	47	66	59	57	55	51	47																							
395		186	500	236	0.01	2	63	57	55	51	46	41	63	56	53	50	45	39	62	56	54	52	47	41	61	56	54	53	48	41	61	55	54	53	49	42	61	55	54	53	49	42																								
55	6	550	260	2000	944	0.01	2	80	77	74	73	70	70	80	76	75	72	71	72	80	76	75	72	71	72	81	76	75	73	71	73	81	76	75	73	71	73	81	76	75	73	71	73																							
		400	189	1600	755	0.00	1	76	73	70	69	66	65	76	71	71	68	66	67	77	72	72	68	66	67	77	73	72	68	67	68	78	73	72	68	67	68	78	73	72	68	67	68																							
		400	189	1200	566	0.01	2	72	69	66	63	60	57	74	70	68	64	62	61	74	70	68	64	62	61	75	70	68	64	62	61	75	70	68	64	62	61	75	70	68	64	62	61																							
		235	111	800	378	0.00	1	67	62	59	56	51	47	68	62	61	56	53	51	69	63	61	56	54	51	69	63	62	56	54	51	69	63	62	56	54	51	69	63	62	56	54	51																							
		235	111	500	236	0.01	2	60	55	52	47	42	35	64	59	55	50	46	40	64	59	55	50	46	40	65	59	55	50	46	40	65	59	55	50	46	40	65	59	55	50	46	40																							
	8	1100	520	2000	944	0.03	7	80	77	74	73	70	70	81	78	74	73	70	70	80	77	74	73	70	70	81	78	74	73	71	70	81	78	74	73	71	70	81	78	74	73	71	70																							
		700	331	1600	755	0.02	4	76	73	70	69	66	65	76	72	70	68	65	64	77	73	70	68	66	65	77	73	70	68	66	65	77	74	70	68	66	65	77	74	70	68	66	65																							
		700	331	1200	566	0.02	5	72	69	66	63	60	57	74	70	66	64	61	58																																															

Performance Data • Radiated Sound Power Levels

Model Series 33SZ • Series Flow • FPCWTU (DOAS)

Unit Size	Inlet Size	Primary Airflow		Fan Airflow		Min. inlet ΔPs "w.g. Pa	Fan and 100% Primary Air-Sound Power Octave Bands @ Inlet pressure (ΔPs) shown																																		
							Fan Only							Minimum ΔPs							0.5" w.g. Inlet Static							1.0" w.g. Inlet Static							1.5" w.g. Inlet Static						
							2	3	4	5	6	7	2	3	4	5	6	7	2	3	4	5	6	7	2	3	4	5	6	7	2	3	4	5	6	7					
10	4	500	236	500	236	0.20	50	66	58	56	51	46	42	70	65	61	53	43	34	73	69	64	58	48	38	77	72	67	61	51	43	79	74	69	63	53	45				
		350	165	400	189	0.07	17	63	55	53	48	42	35	68	63	59	52	41	32	72	67	62	57	47	38	75	70	65	61	51	42	77	72	67	63	53	45				
		200	95	300	142	0.05	12	59	50	49	43	37	27	65	59	56	50	39	30	69	64	61	57	48	39	73	67	64	60	51	43	75	70	65	62	54	45				
		150	71	200	95	0.03	7	53	44	43	37	30	16	61	56	53	46	35	26	66	61	58	54	45	36	70	64	61	58	49	40	72	66	63	60	51	42				
		30	14	100	47	0.02	5	44	33	34	26	18	-3	54	47	46	41	30	21	60	54	53	55	48	38	64	58	56	58	52	43	66	60	58	60	54	45				
		500	236	500	236	0.20	50	66	58	56	51	46	42	70	65	61	53	43	34	73	69	64	58	48	38	77	72	67	61	51	43	79	74	69	63	53	45				
	350	165	400	189	0.07	17	63	55	53	48	42	35	68	61	57	50	39	30	70	65	60	55	45	36	73	68	63	59	49	40	75	70	65	61	51	43					
	200	95	300	142	0.05	12	59	50	49	43	37	27	63	57	54	48	37	28	67	62	59	55	46	37	71	65	62	58	49	41	73	68	63	60	52	43					
	150	71	200	95	0.03	7	53	44	43	37	30	16	59	54	51	44	33	24	64	59	56	52	43	34	68	62	59	56	47	38	70	64	61	58	49	40					
	30	14	100	47	0.02	5	44	33	34	26	18	-3	52	45	44	39	28	19	58	52	51	53	46	36	62	56	54	56	50	41	64	58	56	58	52	43					
	30	4	225	106	1250	590	0.42	104	71	70	67	67	61	53	70	68	65	66	59	49	70	68	65	66	59	51	71	68	66	66	59	53	72	69	66	66	59	55			
			150	71	1000	472	0.15	37	68	65	63	63	56	46	67	64	62	63	55	46	67	64	62	62	54	47	68	64	62	62	55	48	69	65	62	62	55	49			
150			71	800	378	0.20	50	66	61	60	60	51	41	65	61	59	59	50	40	65	60	59	59	50	42	66	61	59	59	51	43	67	61	59	59	51	45				
90			42	500	236	0.06	15	57	51	52	51	40	28	59	52	52	51	40	30	59	52	52	50	40	35	59	53	52	50	41	36	59	54	53	50	41	38				
90			42	250	118	0.10	25	49	48	48	44	33	17	47	48	49	44	34	25	50	49	49	45	36	34	49	49	49	45	37	35	48	49	50	46	38	37				
550			260	1250	590	0.12	30	71	70	67	67	61	53	70	68	65	66	59	50	69	68	65	66	59	52	70	68	66	66	59	55	70	68	66	66	59	58				
400		189	1000	472	0.06	15	68	65	63	63	56	46	67	64	62	63	55	46	67	64	62	62	55	48	67	64	62	62	55	50	67	64	62	62	55	52					
400		189	800	378	0.10	25	66	61	60	60	51	41	62	59	58	58	50	39	63	59	59	59	50	44	64	61	59	59	52	49	66	62	60	60	54	54					
235		111	500	236	0.03	6	57	51	52	51	40	28	57	52	52	51	40	30	60	54	53	52	43	40	62	57	55	54	47	46	64	60	57	56	51	53					
190		90	250	118	0.03	7	49	48	48	44	33	17	48	48	49	44	34	21	53	50	49	46	38	34	53	51	51	48	41	39	54	53	53	49	45	44					
1100		519	1250	590	0.09	22	73	70	67	67	61	53	71	68	66	66	59	50	71	68	66	66	59	53	71	69	66	66	59	56	72	69	67	66	60	59					
700		330	1000	472	0.01	2	70	66	63	63	56	46	67	63	62	62	54	45	67	63	62	62	54	49	68	64	62	62	55	53	69	65	63	63	56	57					
415	196	800	378	0.01	2	67	61	60	59	51	40	64	59	58	58	49	39	64	60	59	58	50	44	65	61	59	59	52	48	67	62	60	59	53	53						
250	118	500	236	0.01	2	56	51	52	50	40	28	57	52	52	50	40	30	58	52	52	51	42	38	59	54	53	51	45	43	60	56	54	52	48	47						
190	90	250	118	0.01	2	48	48	49	44	33	18	47	48	48	43	33	22	52	49	49	45	38	34	53	51	50	47	41	39	54	52	52	48	45	43						
35	4	225	106	2000	945	0.97	241	79	71	69	68	60	50	78	70	68	67	59	49	78	70	68	67	59	49	78	70	68	67	59	50	78	70	68	67	59	51				
		150	71	1600	756	0.40	99	75	68	66	64	56	45	74	67	65	64	55	42	74	67	65	64	55	45	74	67	65	64	55	46	75	67	66	64	55	47				
		150	71	1200	567	0.37	93	70	63	62	60	51	39	70	63	62	59	51	41	70	63	62	59	51	41	69	63	62	60	51	42	70	63	62	60	51	43				
		90	43	800	378	0.12	31	63	57	57	53	43	31	63	57	57	53	44	31	63	58	58	54	44	34	62	58	58	54	44	35	63	58	58	54	44	36				
		90	43	400	189	0.12	29	51	46	49	42	30	16	52	48	50	44	33	24	52	48	50	44	33	24	51	48	50	44	33	25	52	49	51	44	33	26				
		400	189	2000	945	0.37	91	79	71	69	68	60	50	76	68	65	65	57	46	76	68	66	65	57	48	77	68	66	65	57	49	77	69	66	65	57	50				
	300	142	1600	756	0.17	42	75	68	66	64	56	45	72	64	62	61	53	39	73	65	63	62	53	44	73	65	63	62	53	45	73	65	64	62	53	46					
	200	95	1200	567	0.06	16	70	63	62	60	51	39	68	61	60	57	48	38	68	61	60	57	49	39	68	61	60	58	49	41	68	62	60	58	49	41					
	150	71	800	378	0.03	8	63	57	57	53	43	31	61	55	55	51	42	28	61	56	56	52	42	33	61	56	56	52	42	34	61	56	56	52	42	35					
	100	47	400	189	0.01	3	51	46	49	42	30	16	50	46	48	41	31	20	50	46	48	42	31	22	50	46	48	42	31	24	50	47	49	42	31	24					
	550	945	2000	945	0.25	63	79	71	69	68	60	50	80	73	69	68	61	55	80	73	69	68	61	56	80	73	69	68	61	56	80	73	69	68	60	56					
	400	756	1600	756	0.11	27	75	68	66	64	56	45	75	70	66	65	57	49	76	69	66	65	57	51	76	69	66	65	57	52	76	69	66	65	57	52					
400	567	1200	567	0.09	22	70	63	62	60	51	39	71	65	63	61	52	47	71	65	63	60	52	47	71	65	63	60	52	48	71	65	63	60	52	48						
235	378	800	378	0.03	6	63	57	57	53	43	31	64	60	58	54	45	37	65	59	58	54	45	39	65	59	58	54	45	40	65	59	58	54	45	40						
235	189	400	189	0.02	5	51	46	49	42	30	16	53	50	50	44	33	29	53	50	50	44	33	30	54	50	50	44	33	30	54	50	50	44	33	31						
1100	520	2000	945	0.02	6	79	71	69	68	60	50	73	66	65	65	55	37	77	70	67	66	57	52	77	70	67	66	58	53	78	71	67	66	58	54						
700	331	1600	756	0.01	2	75	68	66	64	56	45	69	62	63	61	51	29	74	68	65	63	54	49	74	68	65	63	55	50	75	68	65	63	55	51						
700	331	1200	567	0.01	2	70	63	62	60	51	39	66	61	60	58	47	32	70	64	61	59	50	46	70	65	62	59	50	47	70	65	62									

Performance Data • Radiated Sound Power Levels

Model Series 33SZ • Series Flow • FPCWTU (DOAS)

Unit Size	Inlet Size	Primary Airflow		Fan Airflow		Min. inlet ΔPs "w.g. Pa	Fan and 100% Primary Air—Sound Power Octave Bands @ Inlet pressure (ΔPs) shown																														
							Fan Only					Minimum ΔPs					0.5" w.g. Inlet Static					1.0" w.g. Inlet Static					1.5" w.g. Inlet Static										
							2	3	4	5	6	7	2	3	4	5	6	7	2	3	4	5	6	7	2	3	4	5	6	7	2	3	4	5	6	7	
50	4	225	106	2000	944	0.51	127	70	68	65	66	65	62	73	69	66	66	65	62	-	-	-	-	-	-	73	70	66	66	65	63	73	71	66	65	65	63
		150	71	1600	755	0.18	45	66	64	61	60	59	56	66	63	61	60	59	56	67	64	61	60	59	56	68	65	62	61	60	57	69	67	63	62	60	58
		150	71	1200	566	0.24	60	63	60	56	54	53	49	62	58	57	55	53	50	63	59	57	55	53	49	63	59	57	55	54	50	64	60	58	56	56	51
		90	42	800	378	0.08	20	60	53	51	48	45	39	59	53	50	48	45	39	59	53	50	48	45	40	59	53	51	49	46	41	60	53	52	50	46	42
		90	42	500	236	0.10	25	60	52	49	45	41	34	58	51	49	45	40	34	58	50	49	45	43	38	57	50	50	46	44	40	56	51	51	47	45	42
	6	550	260	2000	944	0.12	30	70	68	65	66	65	62	73	69	66	66	64	62	72	70	67	66	65	64	72	70	67	66	65	64	72	71	66	65	66	65
		400	189	1600	755	0.04	10	67	64	61	60	59	56	66	63	61	60	59	56	67	64	61	60	60	57	68	66	62	61	61	59	68	67	63	63	62	61
		400	189	1200	566	0.09	22	62	59	56	54	53	49	62	59	58	55	53	50	63	59	58	56	55	52	64	61	59	57	57	55	65	62	60	58	59	59
		235	111	800	378	0.02	5	58	53	51	48	45	39	59	54	50	48	45	40	59	54	51	49	48	44	60	55	53	51	51	49	62	57	55	53	54	53
		235	111	500	236	0.04	10	59	52	48	45	40	33	57	52	49	46	40	35	59	52	50	47	46	43	59	54	52	49	50	48	59	56	54	51	54	53
	8	1100	519	2000	944	0.12	30	71	68	65	66	65	63	74	69	66	67	65	63	73	70	67	67	65	64	74	70	67	66	66	65	74	71	67	66	66	66
		700	330	1600	755	0.02	5	67	64	61	60	59	57	67	63	61	60	59	56	68	65	62	61	60	58	69	66	63	62	61	60	70	68	65	63	62	62
		700	330	1200	566	0.06	15	63	60	57	55	54	50	62	59	58	55	53	50	64	60	58	57	55	52	65	62	60	58	57	56	67	64	61	60	60	59
		415	196	800	378	0.01	2	59	53	51	48	45	39	58	53	50	49	45	39	60	55	52	50	48	45	62	58	54	53	52	50	65	60	57	55	56	55
		250	118	500	236	0.01	2	59	52	49	45	41	34	57	51	49	45	40	34	58	52	50	46	45	41	59	54	52	48	49	46	59	55	54	51	52	50
	10	1840	868	2000	944	0.25	62	70	69	65	65	65	63	73	70	67	66	65	63	73	70	68	67	66	64	74	71	69	67	66	65	75	72	70	68	67	67
		1100	519	1600	755	0.08	20	66	64	61	60	59	57	66	63	61	60	59	56	68	65	62	61	60	58	69	66	63	62	61	60	70	67	64	63	62	62
		660	311	1200	566	0.01	2	62	59	56	54	53	49	61	58	56	54	52	49	63	59	57	55	54	51	64	61	58	56	57	55	66	63	60	58	59	59
		410	193	800	378	0.01	2	60	53	51	48	45	38	60	52	50	47	44	38	60	54	51	49	49	45	61	56	53	51	52	49	62	58	55	53	56	54
		375	177	500	236	0.01	2	59	52	49	45	40	33	58	51	48	45	40	33	59	52	50	47	47	43	60	54	52	50	51	48	60	56	54	52	55	53
	12	2000	944	2000	944	0.09	22	69	69	64	66	65	63	72	69	66	66	64	63	73	70	68	67	65	64	74	72	69	67	66	65	75	73	70	67	67	66
		1600	755	1600	755	0.06	15	66	64	61	60	59	56	66	63	61	60	59	55	68	66	63	62	60	58	70	68	65	64	62	60	72	70	67	66	63	63
		900	425	1200	566	0.01	2	62	60	56	54	53	48	60	58	56	54	52	49	61	58	57	55	53	50	62	59	58	57	55	52	63	60	59	58	57	54
		445	210	800	378	0.01	2	59	54	51	48	45	38	57	53	50	47	44	38	58	54	51	50	48	43	59	55	53	54	51	47	61	57	55	57	55	51
395		186	500	236	0.01	2	58	52	48	45	40	32	57	52	48	45	40	32	59	52	50	49	46	40	59	54	52	53	50	45	60	55	54	57	55	50	
55	6	550	260	2000	944	0.01	2	72	70	65	63	62	58	76	74	68	65	64	62	76	74	68	65	63	62	76	75	68	66	65	64	77	75	69	66	66	65
		400	189	1600	755	0.00	1	69	67	62	59	58	53	72	70	63	60	57	53	74	72	65	62	61	59	74	73	66	63	63	61	75	73	66	64	64	63
		400	189	1200	566	0.01	2	67	63	59	55	53	48	71	69	63	60	59	57	71	69	63	60	59	56	72	70	64	60	61	59	72	70	64	61	62	60
		235	111	800	378	0.00	1	63	58	54	49	46	39	66	63	56	52	51	45	68	65	58	55	55	52	69	65	59	56	57	54	69	66	60	56	58	55
		235	111	500	236	0.01	2	59	52	48	42	38	30	64	60	55	50	52	47	64	60	55	50	52	47	64	60	56	51	53	50	65	61	57	52	54	51
	8	1100	520	2000	944	0.03	7	72	70	65	63	62	58	72	71	67	63	60	58	74	72	68	64	62	61	74	72	69	65	64	63	75	73	69	66	65	65
		700	331	1600	755	0.02	4	69	67	62	59	58	53	68	66	61	57	52	47	72	70	65	61	60	58	72	70	66	62	61	60	73	71	66	63	62	62
		700	331	1200	566	0.02	5	67	63	59	55	53	48	68	65	61	57	55	51	69	66	63	59	58	55	70	67	64	60	59	58	70	68	64	60	60	59
		415	196	800	378	0.01	3	63	58	54	49	46	39	62	59	54	49	46	39	66	62	58	54	54	51	66	63	59	55	56	53	67	64	60	55	57	54
		250	118	500	236	0.01	2	59	52	48	42	38	30	62	58	53	48	50	45	62	58	53	48	50	45	62	58	54	49	51	48	63	59	55	50	52	49
	10	1840	870	2000	944	0.08	19	72	70	65	63	62	58	71	69	67	62	59	58	71	69	68	63	61	60	72	70	69	64	62	62	73	71	69	65	63	63
		1100	520	1600	755	0.04	9	69	67	62	59	58	53	66	63	60	55	50	45	70	67	65	60	58	57	70	68	65	61	60	59	71	68	66	62	61	60
		660	312	1200	566	0.02	5	67	63	59	55	53	48	66	63	60	55	53	50	67	64	61	57	56	53	68	65	62	57	57	56	68	66	62	58	58	57
		410	194	800	378	0.01	3	63	58	54	49	46	39	60	56	52	47	43	36	64	60	56	52	52	49	64	61	57	53	54	51	65	62	58	53	55	52
		375	177	500	236	0.02	4	59	52	48	42	38	30	58	54	51	46	46	40	60	55	53	47	48	44	60	56	54	48	50	46	61	57	54	49	51	48
	12	2000	945	2000	944	0.09	22	72	70	65	63	62	58	71	69	67	62	59	58	71	69	66	61	59	58	70	68	67	62	60	60	71	68	68	63	61	62
		1600	756	1600	755	0.08	20	69	67	62	59	58	53	68	65	64	59	57	55	68	65	64	59	57	55	68	66	65	60	58	58	69	66	65	60	59	59
		900	425	1200	566	0.06	14	67	63	59	55	53	48	66	63	61	57	53	20	65	62	60	55	54	52	66	63	61	56	56	54	66	63	61	57	57	55
		445	210	800	378	0.02	6	63	58	54	49	46	39	63	58	54	49	46	39	63	58	55	50	50	47	62	59	55	51								

Performance Notes

Model 33SZ • Series Flow • FPCWTU (DOAS)

Explanation of NC Levels:

1. NC levels are calculated from the published raw data and based on procedures outlined in AHRI Standard 885, Appendix E.
2. Discharge sound attenuation deductions are based on environmental effect, duct lining, branch power division, insulated flex duct, end reflection and space effect and are as follows:

Discharge attenuation	Octave Band					
	2	3	4	5	6	7
< 300 cfm	24	28	39	53	59	40
300 – 700 cfm	27	29	40	51	53	39
> 700 cfm	29	30	41	51	52	39

3. Radiated sound attenuation deductions are based on a mineral tile ceiling and environmental effect and are as follows:

Radiated attenuation	Octave Band					
	2	3	4	5	6	7
Total dB reduction	18	19	20	26	31	36

Performance Notes for Sound Power Levels:

1. Discharge sound power is the noise emitted from the unit discharge into the downstream duct.
2. Radiated sound power is the breakout noise transmitted through the unit casing walls.
3. Sound power levels are in decibels, dB re 10⁻¹² watts.
4. All sound data listed by octave bands is raw data without any corrections for room absorption or duct attenuation. Dash (-) in space indicates sound power level is less than 20 dB or equal to background.

4. Min. inlet ΔPs is the minimum static pressure required to achieve rated airflow (damper full open).
5. Dash (-) in space denotes an NC level of less than 20.
6. Discharge (external) static pressure is 0.25" w.g. (63 Pa) in all cases.
7. For a detailed explanation of the attenuation factors and the procedures for calculating room NC levels, please refer to the Performance Data Explanation in this section and the Acoustical Engineering Guidelines in the Engineering Section of this catalog.

5. Minimum inlet ΔPs is the minimum operating pressure of the primary air valve.
6. Asterisk (*) in space indicates that the minimum inlet static pressure requirement is greater than 0.5" w.g. (125 Pa) at rated airflow.
7. Data derived from independent tests conducted in accordance with ANSI/ASHRAE Standard 130.

Performance Data • Sensible Chilled Water Coil

Models: 33SZ, 33SZE, 33SZW • FPCWTU (DOAS) • Series Flow

Unit Size 10

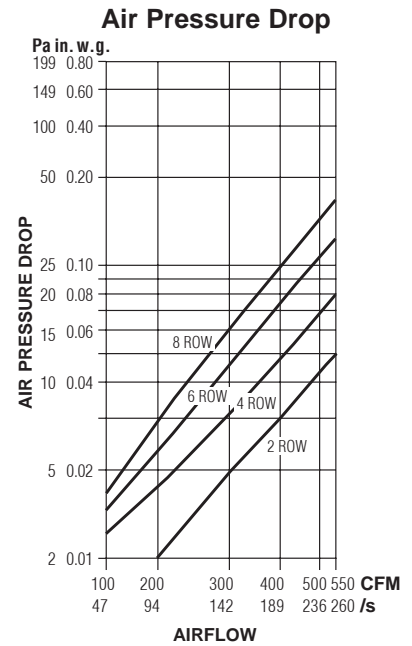
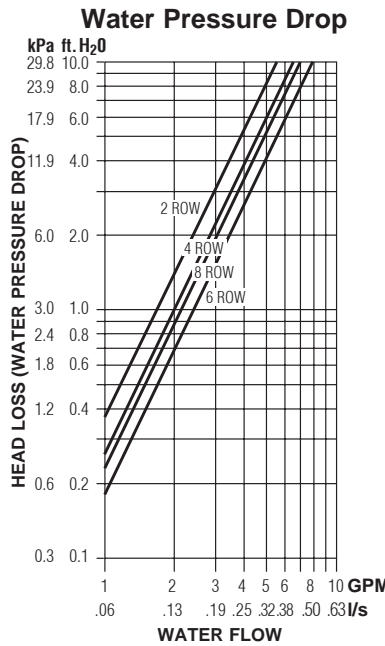
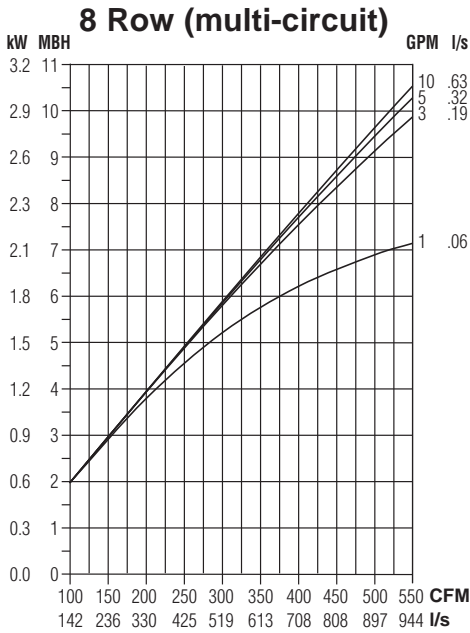
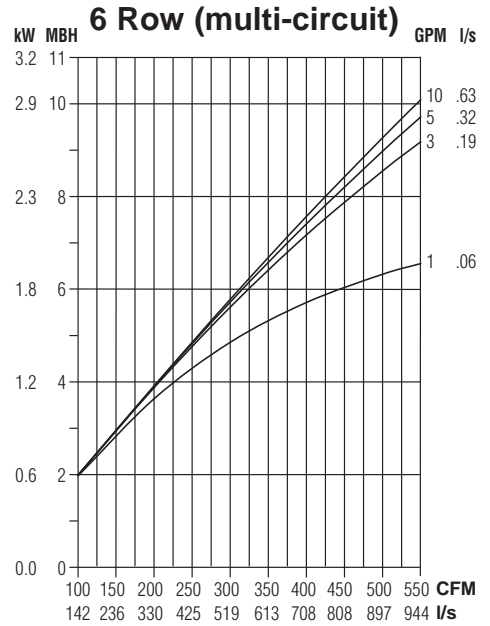
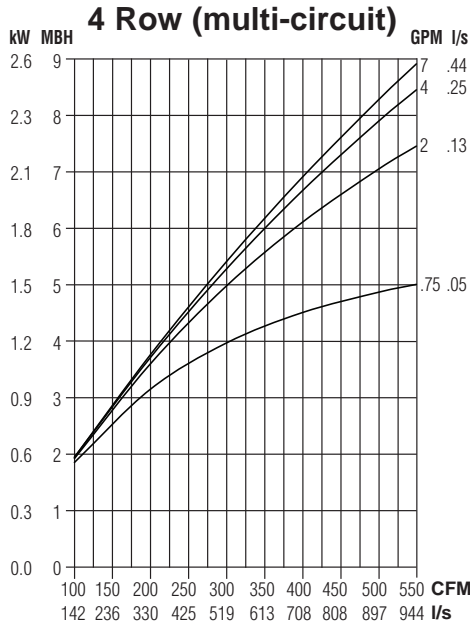
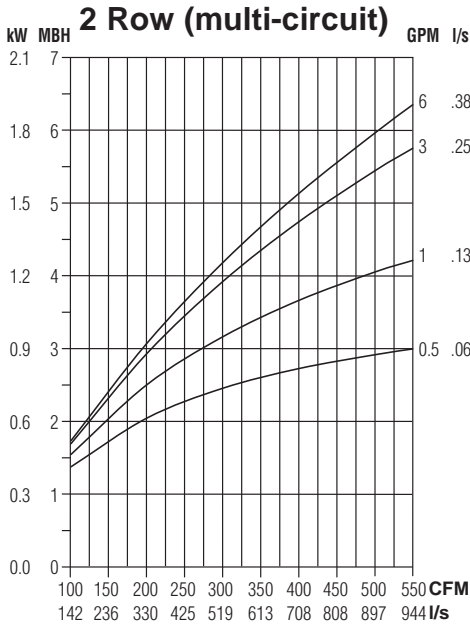

NOTES:

- Capacities are in MBH (kW), **thousands of Btu per hour (kiloWatts)**.
- MBH (kW) values are based on:
57°F (32°C) Entering Water Temperature (EWT) and 75°F (42°C) Entering Air
- Air Temperature Rise.

Temperature (EAT). Entering water temperature must be above return air dew point to prevent condensation.

$$ATR (°F) = 927 \times \frac{MBH}{cfm}, \quad ATR (°C) = 829 \times \frac{kW}{I/s}$$

- Water Temp. Drop.
 $WTD (°F) = 2.04 \times \frac{MBH}{GPM}, \quad WTD (°C) = .224 \times \frac{kW}{I/s}$
- Connections: 2, 4, 6 & 8 Row: 7/8" (22) O.D. male solder.

Altitude Correction Factors:

Attitude (ft.)	0	1000	2000	3000	4000	5000	6000	7000
Air Density (lb./cu.ft.)	0.075	0.072	0.070	0.067	0.065	0.063	0.060	0.058
Sensible Capacity	1000	0.960	0.930	0.900	0.860	0.830	0.800	0.700



Performance Data • Hot Water Coil

Model: 33SZW • FPCWTU (DOAS) • Series Flow

Unit Size 10

1 Row (single-circuit)

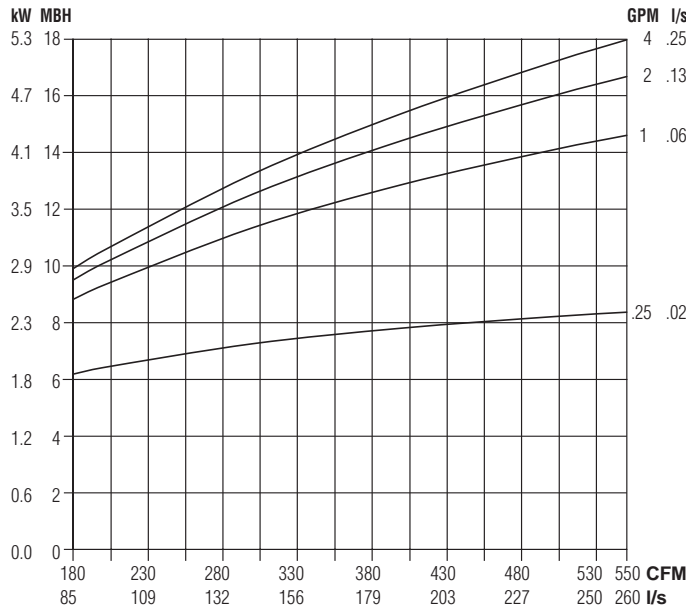

2 Row (multi-circuit)

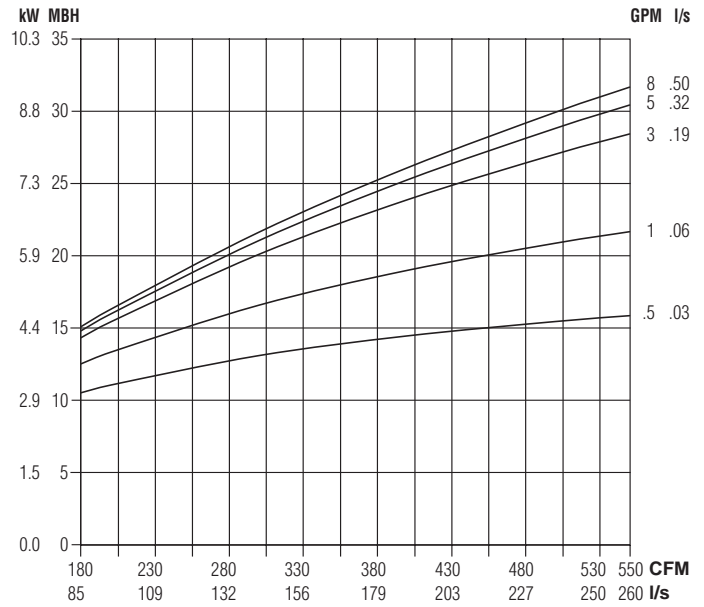

Water Pressure Drop

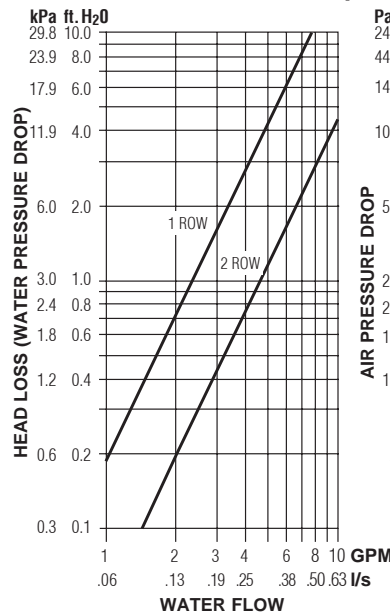

Air Pressure Drop

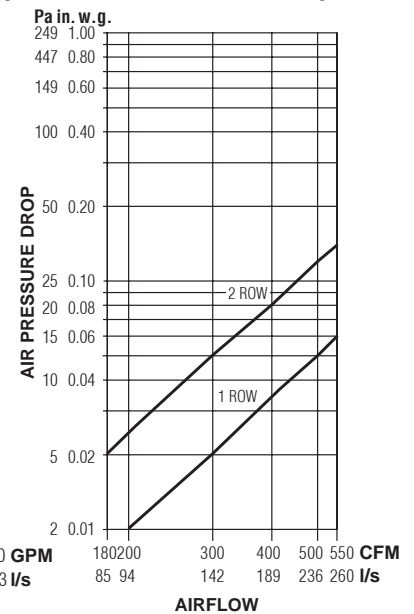

NOTES:

- Capacities are in MBH (kW), *thousands of Btu per hour (kiloWatts)*.
- MBH (kW) values are based on a Δt (temperature difference) of 120°F (67°C) between entering air and entering water. For other Δt 's; multiply the MBH (kW) values by the factors below.

- Air Temperature Rise.
 $ATR (^\circ F) = 927 \times \frac{MBH}{cfm}$, $ATR (^\circ C) = 829 \times \frac{kW}{l/s}$
- Water Temp. Drop.
 $WTD (^\circ F) = 2.04 \times \frac{MBH}{GPM}$, $WTD (^\circ C) = .224 \times \frac{kW}{l/s}$
- Connections: 1 Row 1/2" (13) and 2 Row 5/8" (16); O.D. male solder.

Altitude Correction Factors:

Altitude ft. (m)	Sensible Heat Factor
0 (0)	1.00
2000 (610)	0.94
3000 (914)	0.90
4000 (1219)	0.87
5000 (1524)	0.84
6000 (1829)	0.81
7000 (2134)	0.78

Correction factors at other entering conditions:

Δt °F (°C)	50 (28)	60 (33)	70 (39)	80 (44)	90 (50)	100 (56)	110 (61)	120 (67)	130 (72)	140 (78)	150 (83)
Factor	.417 (.418)	.500 (.493)	.583 (.582)	.667 (.657)	.750 (.746)	.833 (.836)	.917 (.910)	1.00 (1.00)	1.08 (1.08)	1.17 (1.16)	1.25 (1.24)

Performance Data • Sensible Chilled Water Coil

Models: 33SZ, 33SZE, 33SZW • FPCWTU (DOAS) • Series Flow

Unit Size 30

2 Row (multi-circuit)

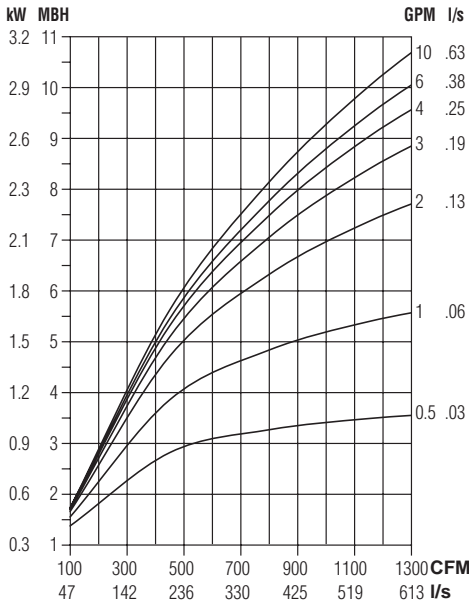

4 Row (multi-circuit)

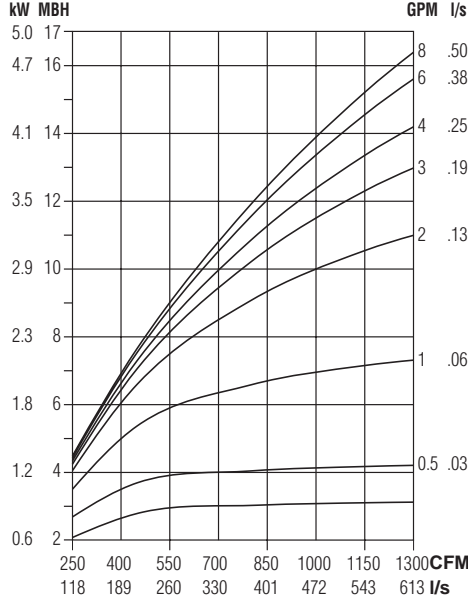

6 Row (multi-circuit)

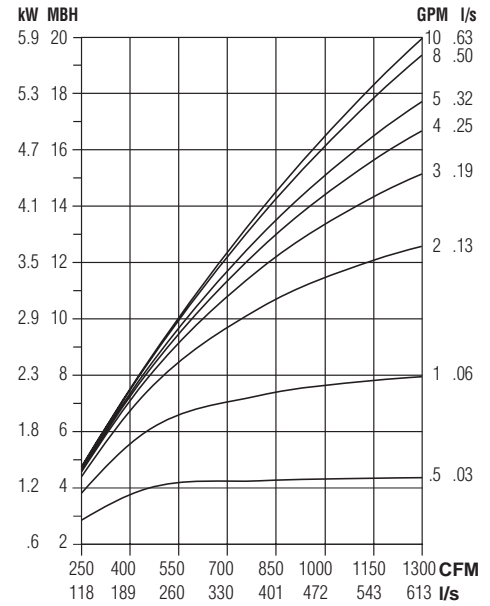

8 Row (multi-circuit)

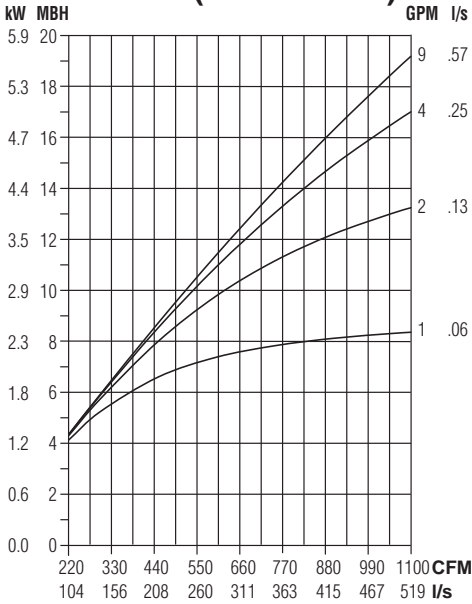

Water Pressure Drop

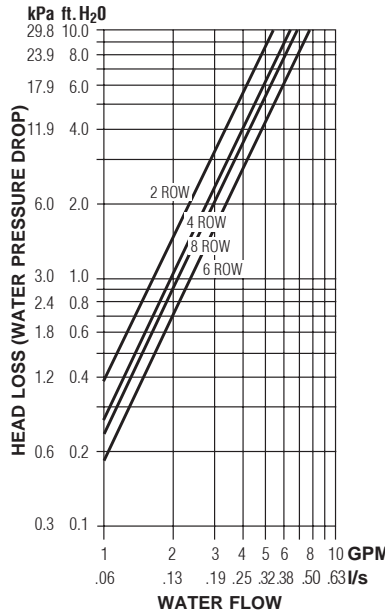

Air Pressure Drop

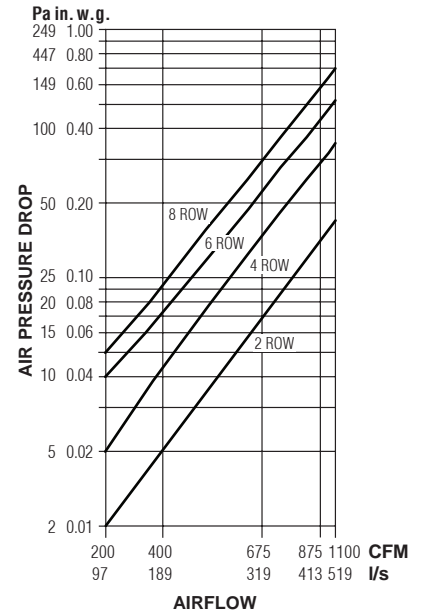

NOTES:

- Capacities are in MBH (kW), **thousands of Btu per hour (kiloWatts)**.
- MBH (kW) values are based on:
57°F (32°C) Entering Water Temperature (EWT) and 75°F (42°C) Entering Air

Temperature (EAT). Entering water temperature must be above return air dew point to prevent condensation.

- Air Temperature Rise.

$$ATR (°F) = 927 \times \frac{MBH}{cfm}, \quad ATR (°C) = 829 \times \frac{kW}{I/s}$$

- Water Temp. Drop.

$$WTD (°F) = 2.04 \times \frac{MBH}{GPM}, \quad WTD (°C) = .224 \times \frac{kW}{I/s}$$

- Connections: 2, 4, 6 & 8 Row: 7/8" (22) O.D. male solder.

Altitude Correction Factors:

Attitude (ft.)	0	1000	2000	3000	4000	5000	6000	7000
Air Density (lb./cu.ft.)	0.075	0.072	0.070	0.067	0.065	0.063	0.060	0.058
Sensible Capacity	1000	0.960	0.930	0.900	0.860	0.830	0.800	0.700

FAN POWERED TERMINAL UNITS



Performance Data • Hot Water Coil

Model: 33SZW • FPCWTU (DOAS) • Series Flow

Unit Size 30

1 Row (single-circuit)

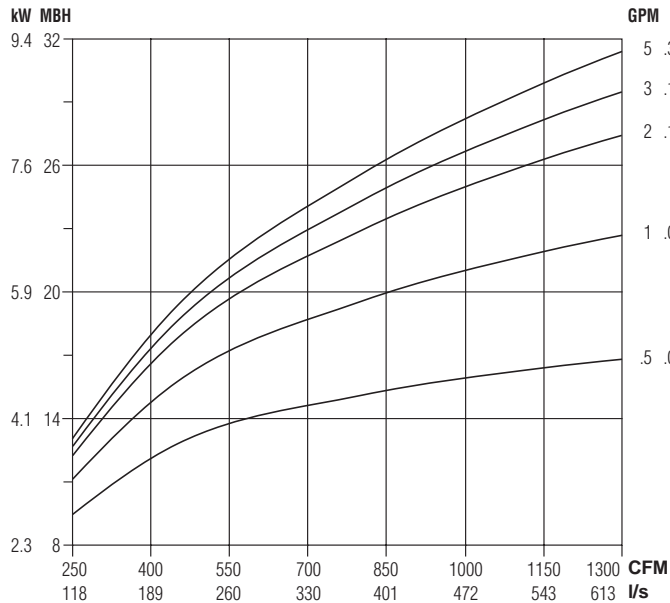

2 Row (multi-circuit)

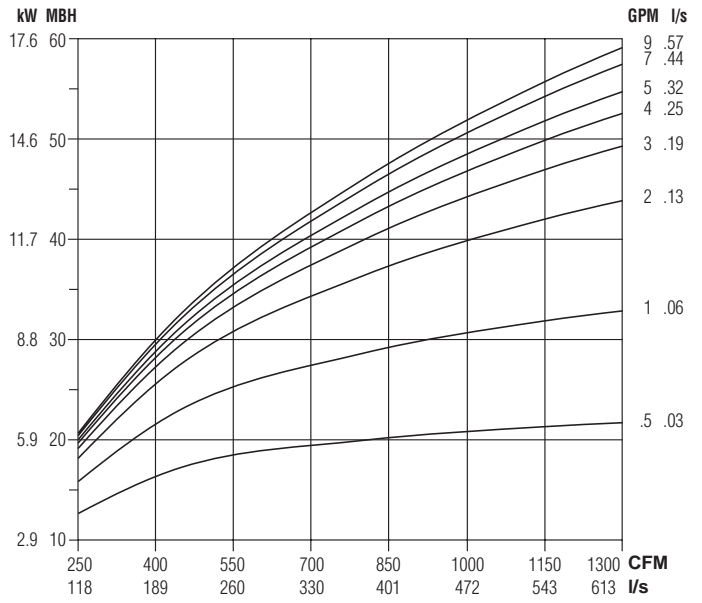

Water Pressure Drop

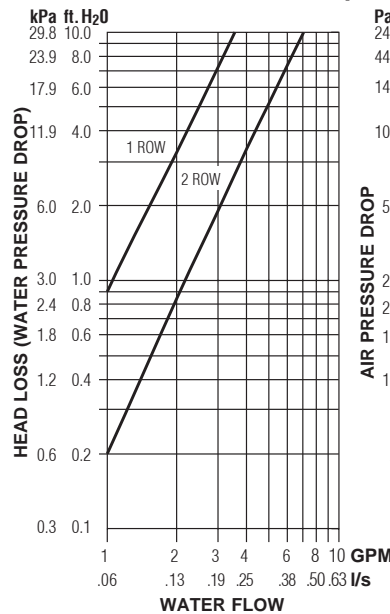

Air Pressure Drop

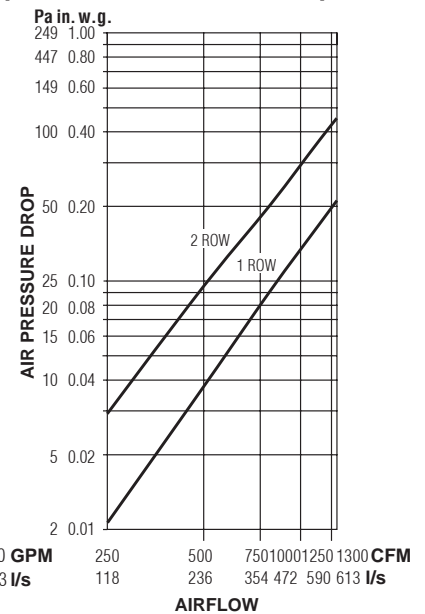

NOTES:

- Capacities are in MBH (kW), *thousands of Btu per hour (kiloWatts)*.
- MBH (kW) values are based on a Δt (temperature difference) of 120°F (67°C) between entering air and entering water. For other Δt 's; multiply the MBH (kW) values by the factors below.

- Air Temperature Rise.
 $ATR (^\circ F) = 927 \times \frac{MBH}{cfm}$, $ATR (^\circ C) = 829 \times \frac{kW}{l/s}$
- Water Temp. Drop.
 $WTD (^\circ F) = 2.04 \times \frac{MBH}{GPM}$, $WTD (^\circ C) = .224 \times \frac{kW}{l/s}$
- Connections: 1 Row 1/2" (13) and 2 Row 5/8" (16); O.D. male solder.

Altitude Correction Factors:

Altitude ft. (m)	Sensible Heat Factor
0 (0)	1.00
2000 (610)	0.94
3000 (914)	0.90
4000 (1219)	0.87
5000 (1524)	0.84
6000 (1829)	0.81
7000 (2134)	0.78

Correction factors at other entering conditions:

Δt °F (°C)	50 (28)	60 (33)	70 (39)	80 (44)	90 (50)	100 (56)	110 (61)	120 (67)	130 (72)	140 (78)	150 (83)
Factor	.417 (.418)	.500 (.493)	.583 (.582)	.667 (.657)	.750 (.746)	.833 (.836)	.917 (.910)	1.00 (1.00)	1.08 (1.08)	1.17 (1.16)	1.25 (1.24)

Performance Data • Sensible Chilled Water Coil

Models: 33SZ, 33SZE, 33SZW • FPCWTU (DOAS) • Series Flow

Unit Size 35 (Low Profile)

2 Row (multi-circuit)

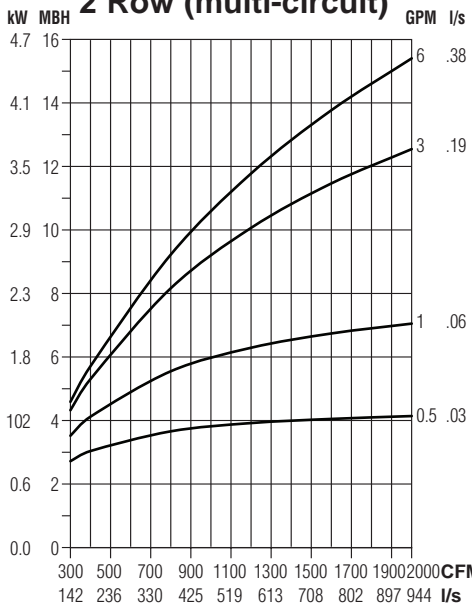

4 Row (multi-circuit)

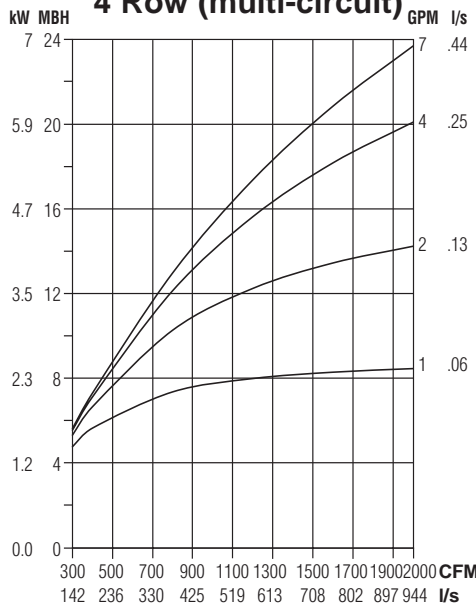

6 Row (multi-circuit)

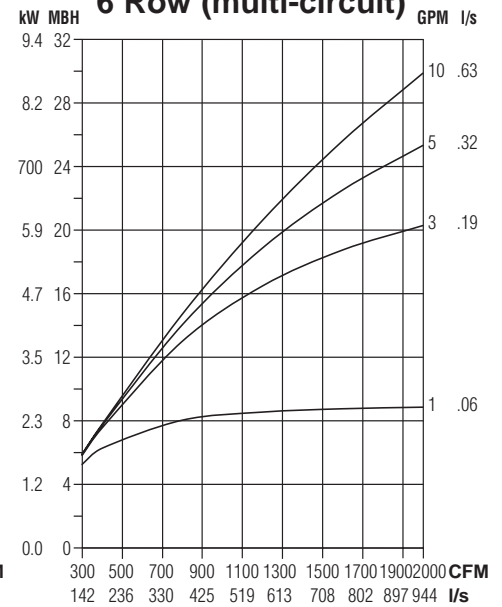

8 Row (multi-circuit)

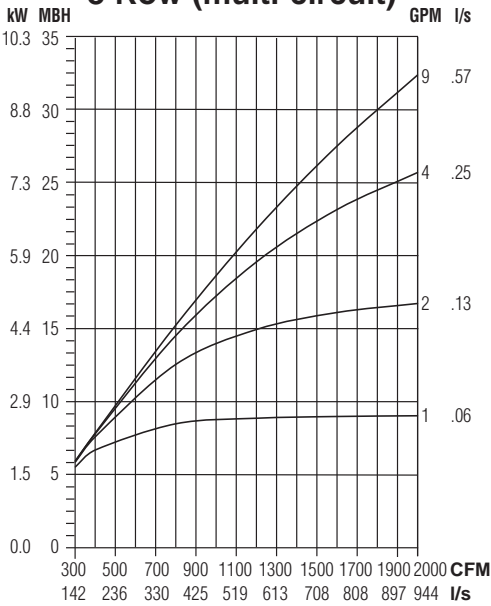

Water Pressure Drop

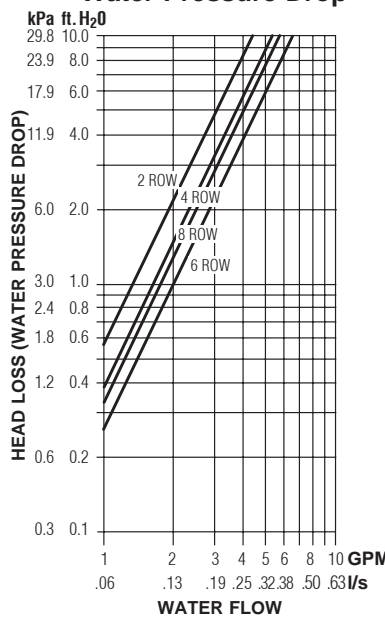

Air Pressure Drop

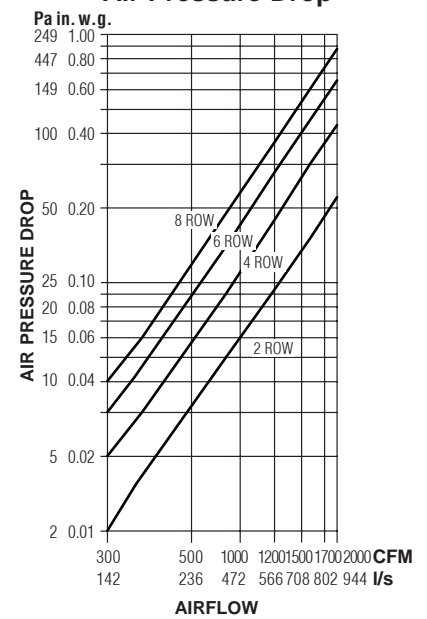

NOTES:

- Capacities are in MBH (kW), **thousands of Btu per hour (kiloWatts)**.
- MBH (kW) values are based on:
57°F (32°C) Entering Water Temperature (EWT) and 75°F (42°C) Entering Air
- Air Temperature Rise.

Temperature (EAT). Entering water temperature must be above return air dew point to prevent condensation.

ATR (°F) = $927 \times \frac{\text{MBH}}{\text{cfm}}$, ATR (°C) = $829 \times \frac{\text{kW}}{\text{l/s}}$

- Water Temp. Drop.
WTD (°F) = $2.04 \times \frac{\text{MBH}}{\text{GPM}}$, WTD (°C) = $.224 \times \frac{\text{kW}}{\text{l/s}}$
- Connections: 2, 4, 6 & 8 Row: 7/8" (22) O.D. male solder.

Altitude Correction Factors:

Attitude (ft.)	0	1000	2000	3000	4000	5000	6000	7000
Air Density (lb./cu.ft.)	0.075	0.072	0.070	0.067	0.065	0.063	0.060	0.058
Sensible Capacity	1000	0.960	0.930	0.900	0.860	0.830	0.800	0.700

FAN POWERED TERMINAL UNITS



Performance Data • Hot Water Coil

Model: 33SZW • FPCWTU (DOAS) • Series Flow

Unit Size 35 (Low Profile)

1 Row (multi-circuit)

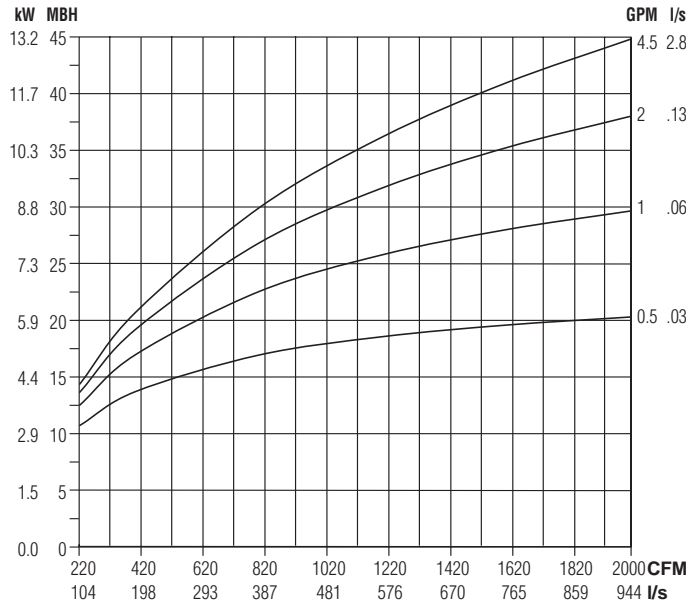

2 Row (multi-circuit)

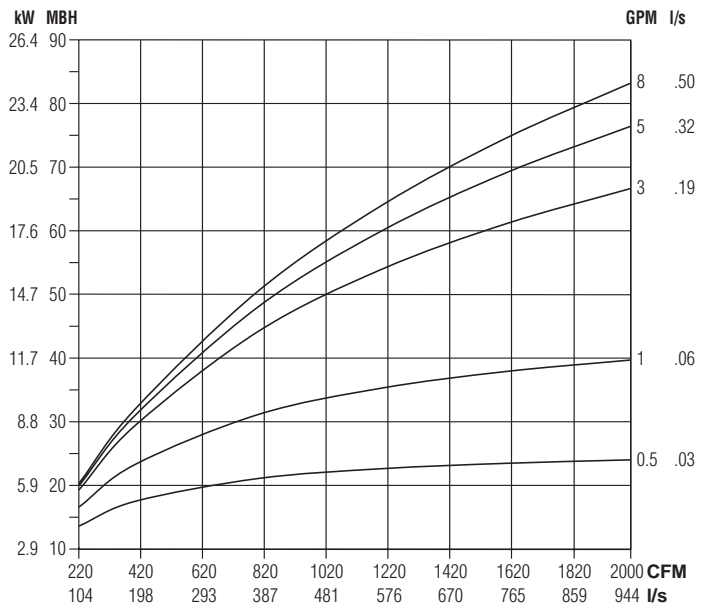

Water Pressure Drop

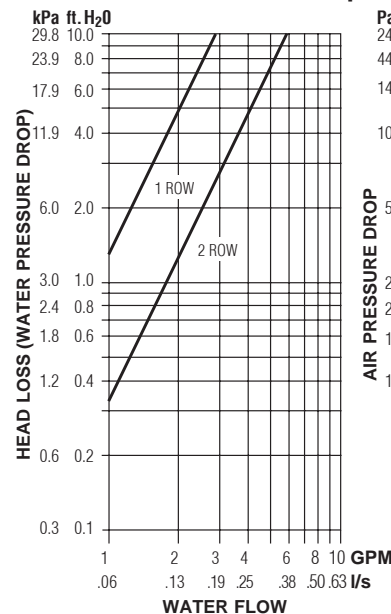

Air Pressure Drop

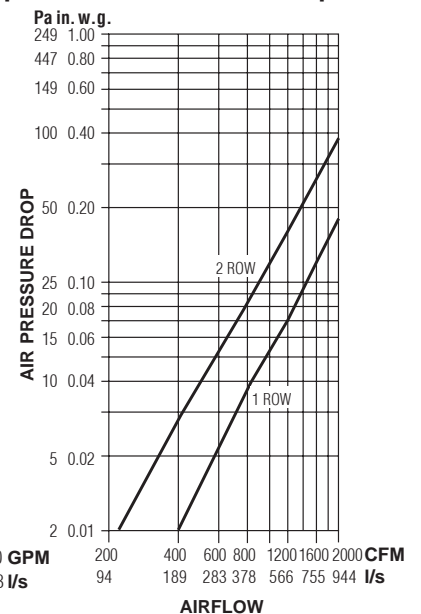

NOTES:

- Capacities are in MBH (kW), *thousands of Btu per hour (kiloWatts)*.
- MBH (kW) values are based on a Δt (temperature difference) of 120°F (67°C) between entering air and entering water. For other Δt 's; multiply the MBH (kW) values by the factors below.

- Air Temperature Rise.
 $ATR (^\circ F) = 927 \times \frac{MBH}{cfm}$, $ATR (^\circ C) = 829 \times \frac{kW}{l/s}$
- Water Temp. Drop.
 $WTD (^\circ F) = 2.04 \times \frac{MBH}{GPM}$, $WTD (^\circ C) = .224 \times \frac{kW}{l/s}$
- Connections: 1 Row 1/2" (13) and 2 Row 7/8" (22); O.D. male solder.

Altitude Correction Factors:

Altitude ft. (m)	Sensible Heat Factor
0 (0)	1.00
2000 (610)	0.94
3000 (914)	0.90
4000 (1219)	0.87
5000 (1524)	0.84
6000 (1829)	0.81
7000 (2134)	0.78

Correction factors at other entering conditions:

Δt °F (°C)	50 (28)	60 (33)	70 (39)	80 (44)	90 (50)	100 (56)	110 (61)	120 (67)	130 (72)	140 (78)	150 (83)
Factor	.417 (.418)	.500 (.493)	.583 (.582)	.667 (.657)	.750 (.746)	.833 (.836)	.917 (.910)	1.00 (1.00)	1.08 (1.08)	1.17 (1.16)	1.25 (1.24)

Performance Data • Sensible Chilled Water Coil

Models: 33SZ, 33SZE, 33SZW • FPCWTU (DOAS) • Series Flow

Unit Size 40

2 Row (multi-circuit)

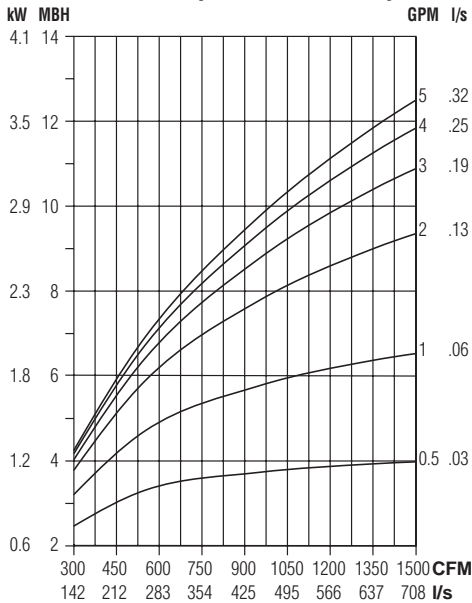

4 Row (multi-circuit)

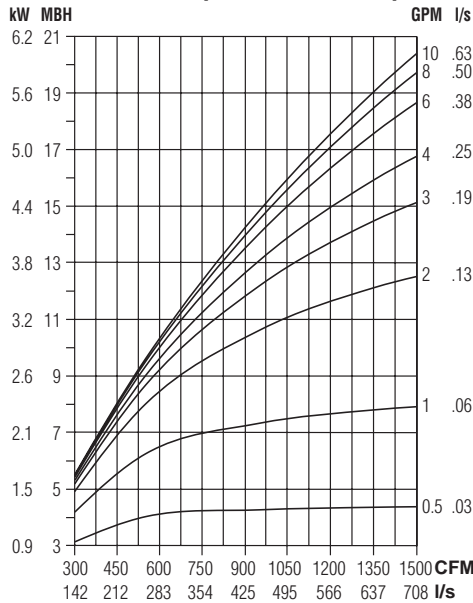

6 Row (multi-circuit)

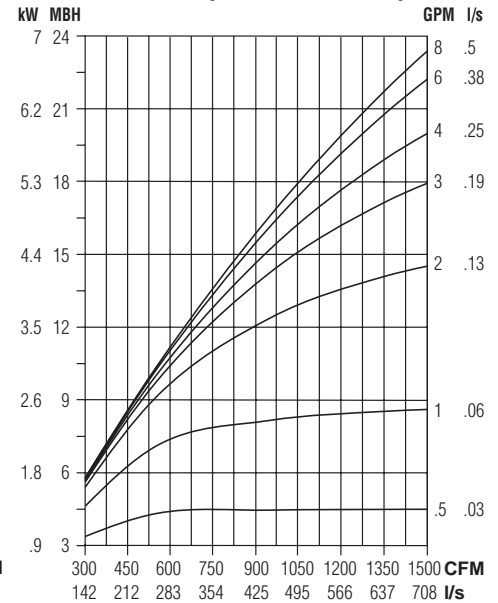

8 Row (multi-circuit)

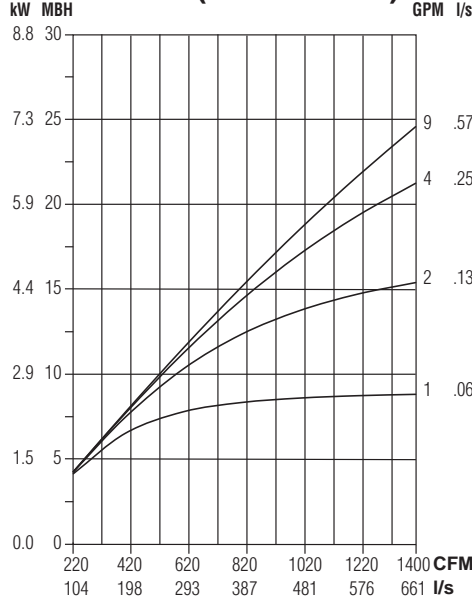

Water Pressure Drop

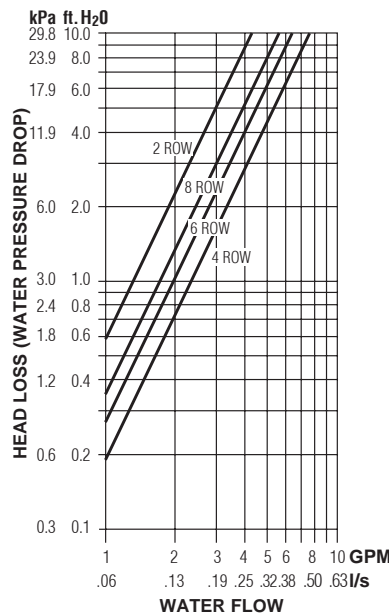

Air Pressure Drop

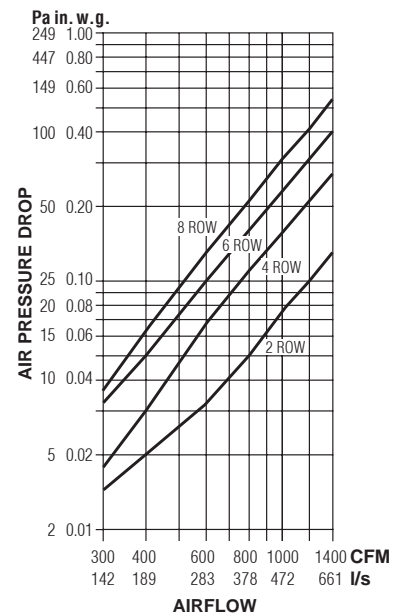

NOTES:

- Capacities are in MBH, *thousands of Btu per hour (kiloWatts)*.
- MBH (kW) values are based on:
57°F (32°C) Entering Water Temperature (EWT) and 75°F (42°C) Entering Air

Temperature (EAT). Entering water temperature must be above return air dew point to prevent condensation.

- Air Temperature Rise.

$$ATR (°F) = 927 \times \frac{MBH}{cfm}, ATR (°C) = 829 \times \frac{kW}{I/s}$$

- Water Temp. Drop.

$$WTD (°F) = 2.04 \times \frac{MBH}{GPM}, WTD (°C) = .224 \times \frac{kW}{I/s}$$

- Connections: 2, 4 & 6 Row: 7/8" (22) O.D. male solder.

Altitude Correction Factors:

Attitude (ft.)	0	1000	2000	3000	4000	5000	6000	7000
Air Density (lb./cu.ft.)	0.075	0.072	0.070	0.067	0.065	0.063	0.060	0.058
Sensible Capacity	1000	0.960	0.930	0.900	0.860	0.830	0.800	0.700

FAN POWERED TERMINAL UNITS



Performance Data • Hot Water Coil

Model: 33SZW • FPCWTU (DOAS) • Series Flow

Unit Size 40

1 Row (single-circuit)

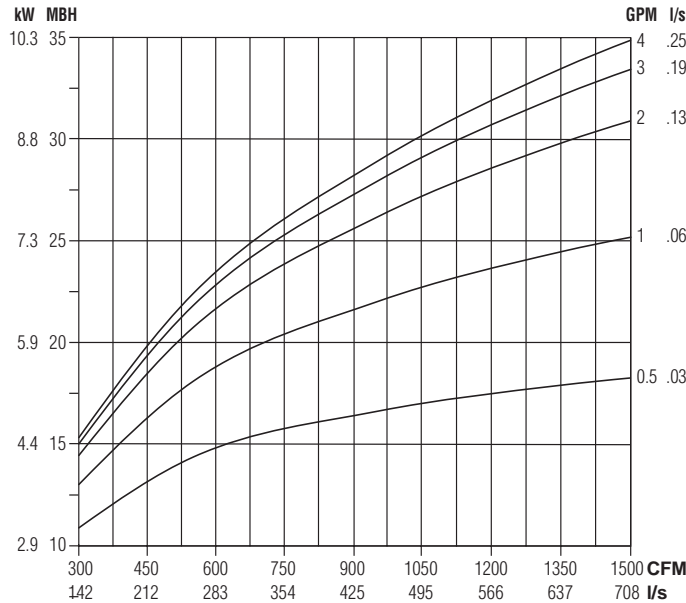

2 Row (multi-circuit)

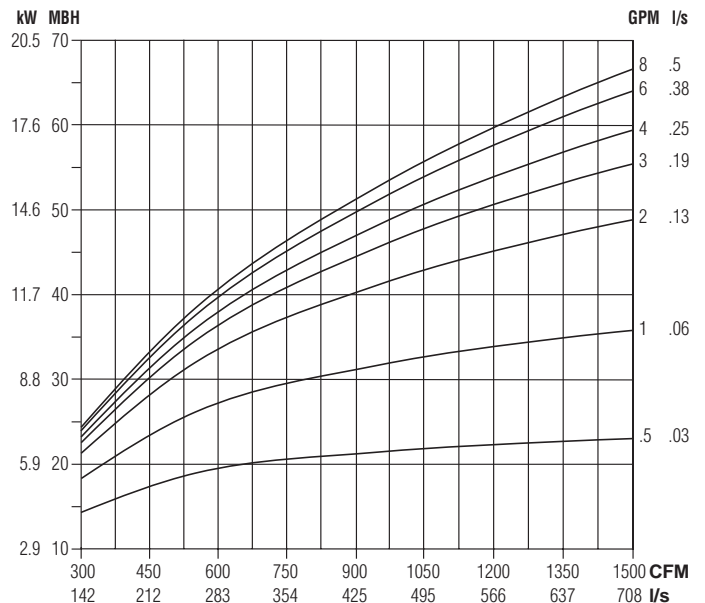

Water Pressure Drop

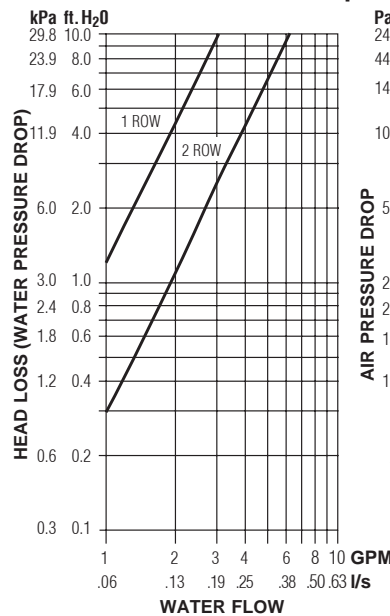

Air Pressure Drop

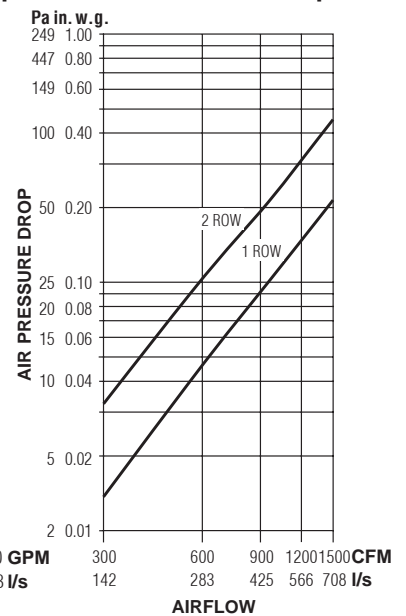

NOTES:

- Capacities are in MBH (kW), *thousands of Btu per hour (kiloWatts)*.
- MBH (kW) values are based on a Δt (temperature difference) of 120°F (67°C) between entering air and entering water. For other Δt 's; multiply the MBH (kW) values by the factors below.

- Air Temperature Rise.
 $ATR (^\circ F) = 927 \times \frac{MBH}{cfm}$, $ATR (^\circ C) = 829 \times \frac{kW}{l/s}$
- Water Temp. Drop.
 $WTD (^\circ F) = 2.04 \times \frac{MBH}{GPM}$, $WTD (^\circ C) = .224 \times \frac{kW}{l/s}$
- Connections: 1 Row 1/2" (13) and 2 Row 7/8" (22); O.D. male solder.

Altitude Correction Factors:

Altitude ft. (m)	Sensible Heat Factor
0 (0)	1.00
2000 (610)	0.94
3000 (914)	0.90
4000 (1219)	0.87
5000 (1524)	0.84
6000 (1829)	0.81
7000 (2134)	0.78

Correction factors at other entering conditions:

Δt °F (°C)	50 (28)	60 (33)	70 (39)	80 (44)	90 (50)	100 (56)	110 (61)	120 (67)	130 (72)	140 (78)	150 (83)
Factor	.417 (.418)	.500 (.493)	.583 (.582)	.667 (.657)	.750 (.746)	.833 (.836)	.917 (.910)	1.00 (1.00)	1.08 (1.08)	1.17 (1.16)	1.25 (1.24)

FAN POWERED TERMINAL UNITS

Performance Data • Sensible Chilled Water Coil

Models: 33SZ, 33SZE, 33SZW • FPCWTU (DOAS) • Series Flow

Unit Size 50

2 Row (multi-circuit)

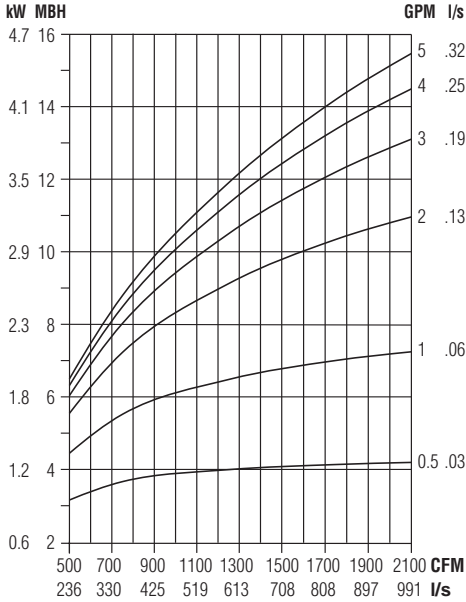

4 Row (multi-circuit)

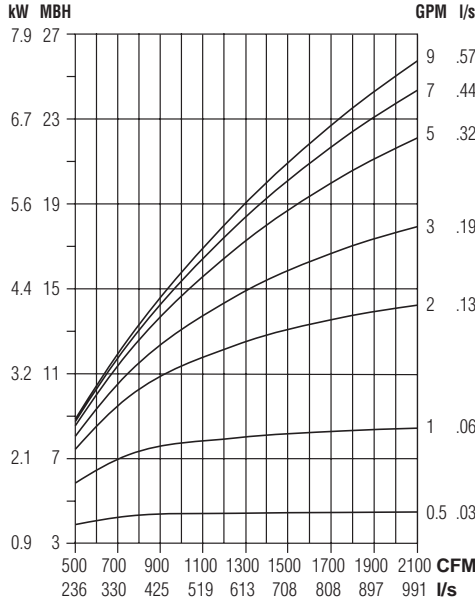

6 Row (multi-circuit)

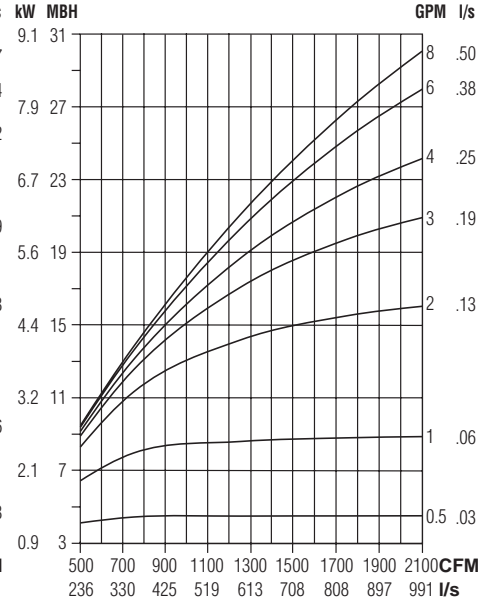

8 Row (multi-circuit)

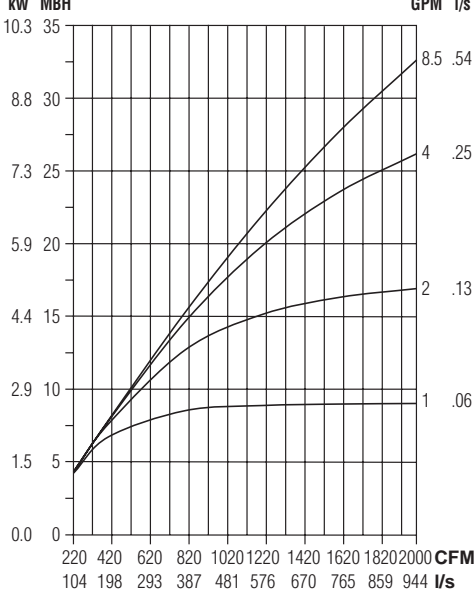

Water Pressure Drop

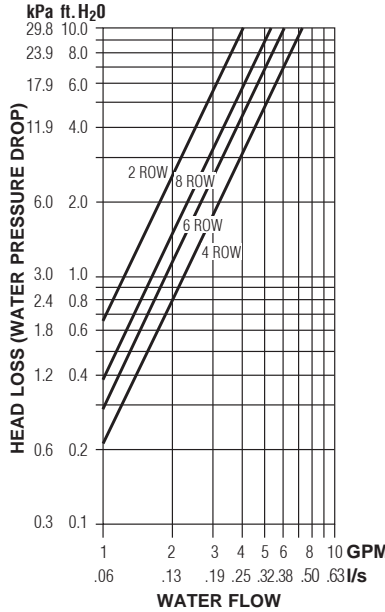

Air Pressure Drop

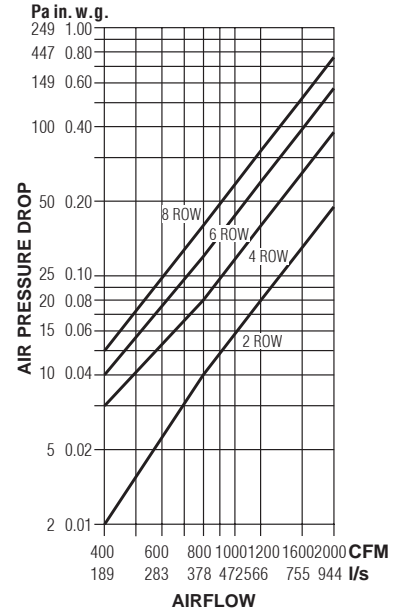

NOTES:

- Capacities are in MBH (kW), **thousands of Btu per hour (kiloWatts)**.
- MBH (kW) values are based on:
57°F (32°C) Entering Water Temperature (EWT) and 75°F (42°C) Entering Air

Temperature (EAT). Entering water temperature must be above return air dew point to prevent condensation.

- Air Temperature Rise.

$$ATR (°F) = 927 \times \frac{MBH}{cfm}, ATR (°C) = 829 \times \frac{kW}{l/s}$$

- Water Temp. Drop.

$$WTD (°F) = 2.04 \times \frac{MBH}{GPM}, WTD (°C) = .224 \times \frac{kW}{l/s}$$

- Connections: 2, 4 & 6 Row: 7/8" (22) O.D. male solder.

Altitude Correction Factors:

Attitude (ft.)	0	1000	2000	3000	4000	5000	6000	7000
Air Density (lb./cu.ft.)	0.075	0.072	0.070	0.067	0.065	0.063	0.060	0.058
Sensible Capacity	1000	0.960	0.930	0.900	0.860	0.830	0.800	0.700

FAN POWERED TERMINAL UNITS



Performance Data • Hot Water Coil

Model: 33SZW • FPCWTU (DOAS) • Series Flow

Unit Size 50

1 Row (multi-circuit)

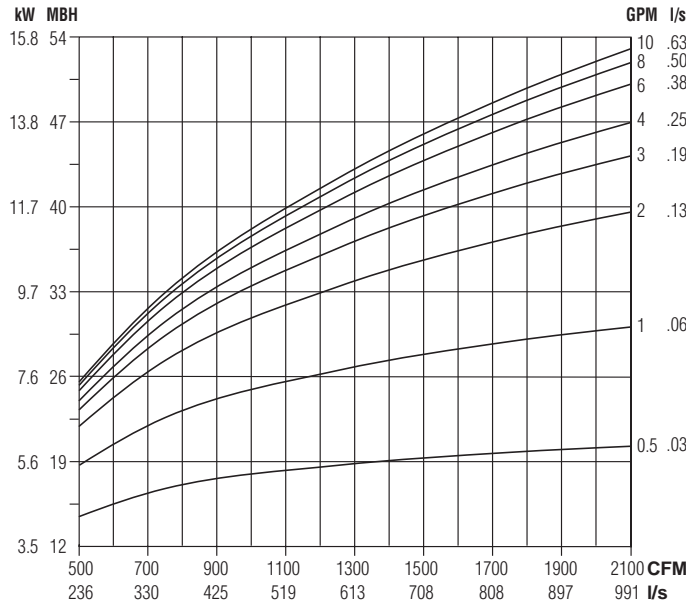

2 Row (multi-circuit)

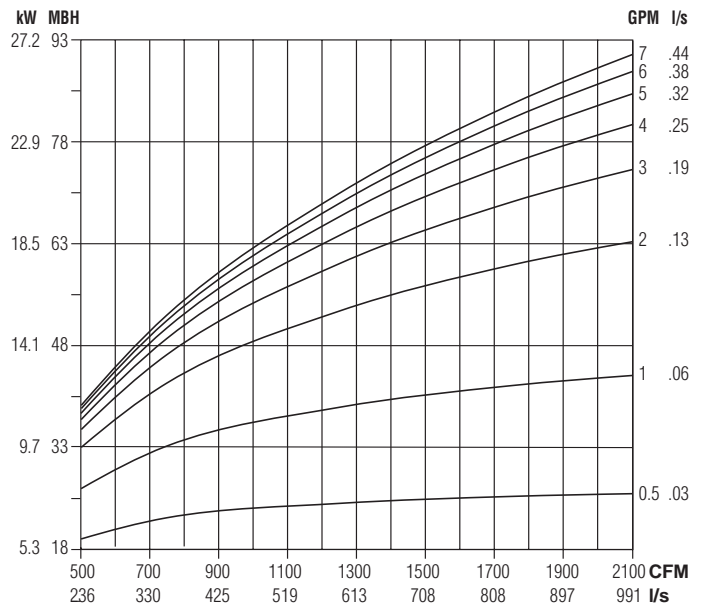

Water Pressure Drop

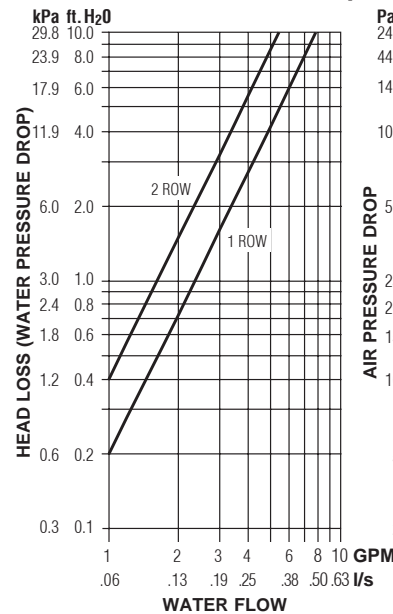

Air Pressure Drop

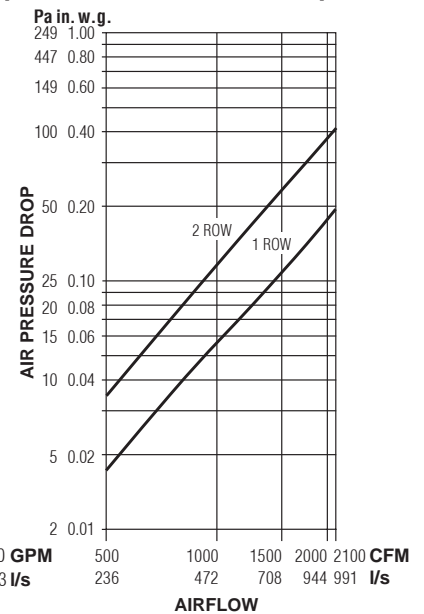

NOTES:

- Capacities are in MBH (kW), *thousands of Btu per hour (kiloWatts)*.
- MBH (kW) values are based on a Δt (temperature difference) of 120°F (67°C) between entering air and entering water. For other Δt 's; multiply the MBH (kW) values by the factors below.

- Air Temperature Rise.
 $ATR (^\circ F) = 927 \times \frac{MBH}{cfm}$, $ATR (^\circ C) = 829 \times \frac{kW}{l/s}$
- Water Temp. Drop.
 $WTD (^\circ F) = 2.04 \times \frac{MBH}{GPM}$, $WTD (^\circ C) = .224 \times \frac{kW}{l/s}$
- Connections: 1 Row 1/2" (13) and 2 Row 7/8" (22); O.D. male solder.

Altitude Correction Factors:

Altitude ft. (m)	Sensible Heat Factor
0 (0)	1.00
2000 (610)	0.94
3000 (914)	0.90
4000 (1219)	0.87
5000 (1524)	0.84
6000 (1829)	0.81
7000 (2134)	0.78

Correction factors at other entering conditions:

Δt °F (°C)	50 (28)	60 (33)	70 (39)	80 (44)	90 (50)	100 (56)	110 (61)	120 (67)	130 (72)	140 (78)	150 (83)
Factor	.417 (.418)	.500 (.493)	.583 (.582)	.667 (.657)	.750 (.746)	.833 (.836)	.917 (.910)	1.00 (1.00)	1.08 (1.08)	1.17 (1.16)	1.25 (1.24)

Performance Data • Sensible Chilled Water Coil

Models: 33SZ, 33SZE, 33SZW • FPCWTU (DOAS) • Series Flow

Unit Size 55

2 Row (multi-circuit)

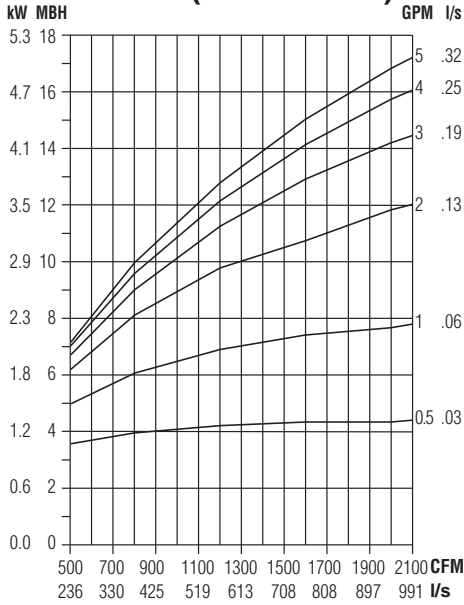

4 Row (multi-circuit)

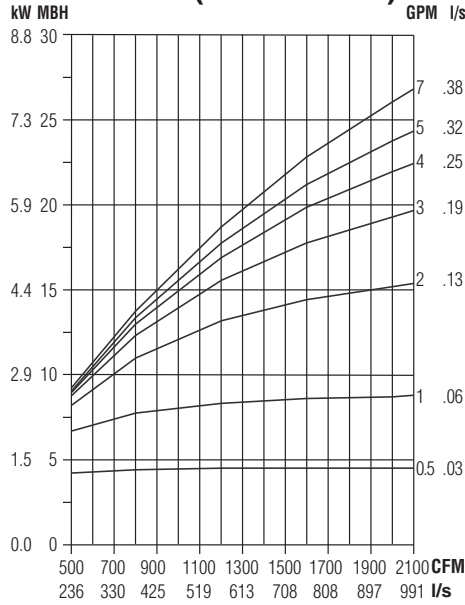

6 Row (multi-circuit)

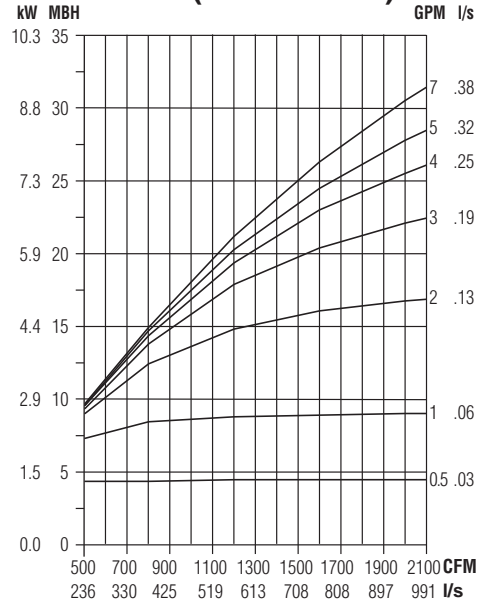

8 Row (multi-circuit)

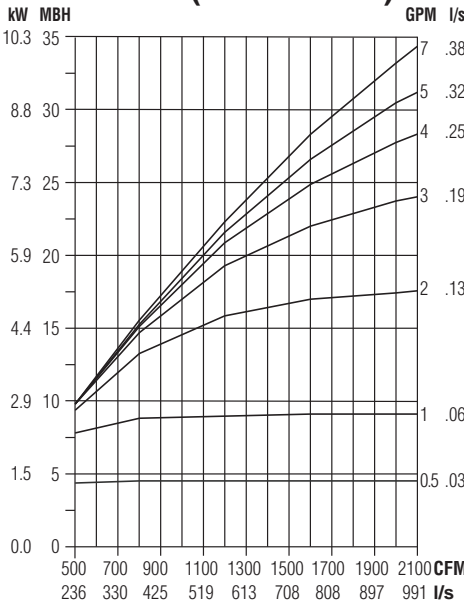

Water Pressure Drop

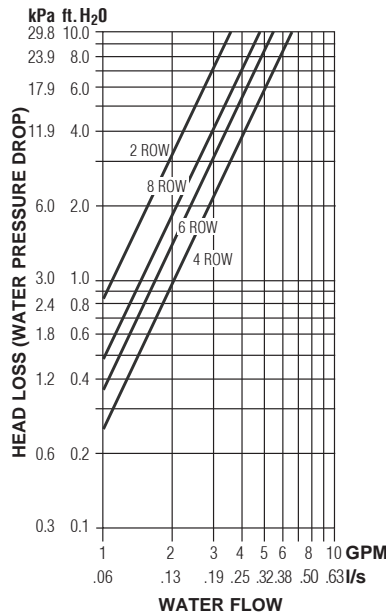

Air Pressure Drop

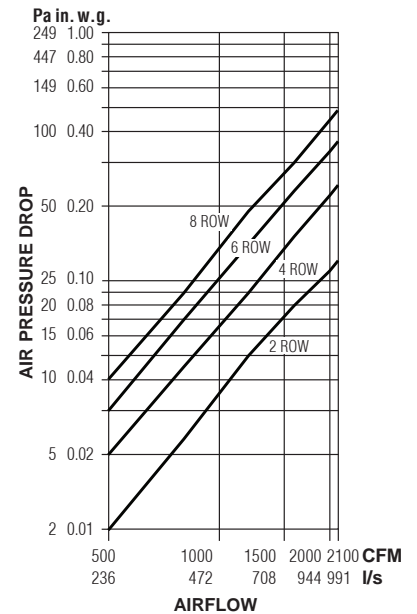

NOTES:

- Capacities are in MBH (kW), **thousands of Btu per hour (kiloWatts)**.
- MBH (kW) values are based on:
57°F (32°C) Entering Water Temperature (EWT) and 75°F (42°C) Entering Air
- Air Temperature Rise.
 $ATR (°F) = 927 \times \frac{MBH}{cfm}$, $ATR (°C) = 829 \times \frac{kW}{l/s}$

Temperature (EAT). Entering water temperature must be above return air dew point to prevent condensation.

- Water Temp. Drop.
 $WTD (°F) = 2.04 \times \frac{MBH}{GPM}$, $WTD (°C) = .224 \times \frac{kW}{l/s}$
- Connections: 2, 4, 6 & 8 Row: 7/8" (22) O.D. male solder.

Altitude Correction Factors:

Attitude (ft.)	0	1000	2000	3000	4000	5000	6000	7000
Air Density (lb./cu.ft.)	0.075	0.072	0.070	0.067	0.065	0.063	0.060	0.058
Sensible Capacity	1000	0.960	0.930	0.900	0.860	0.830	0.800	0.700

FAN POWERED TERMINAL UNITS



Performance Data • Hot Water Coil

Model: 33SZW • FPCWTU (DOAS) • Series Flow

Unit Size 55

1 Row (multi-circuit)

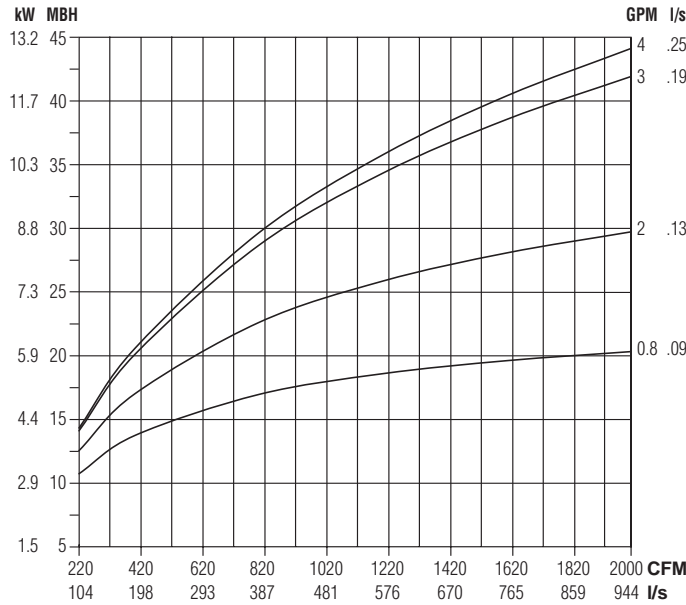

2 Row (multi-circuit)

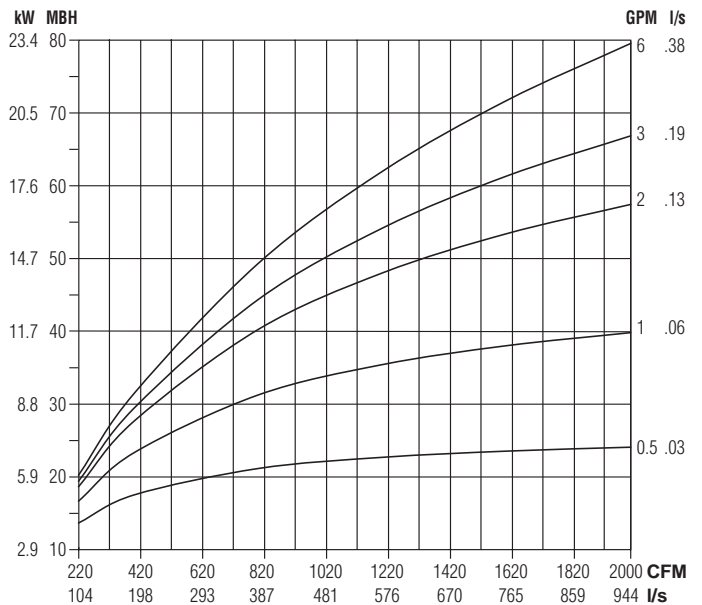

Water Pressure Drop

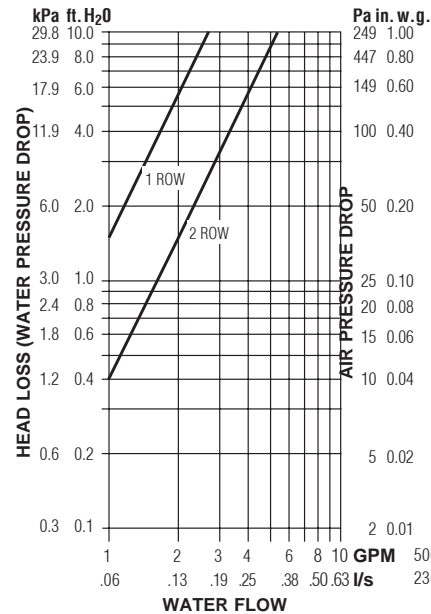

Air Pressure Drop

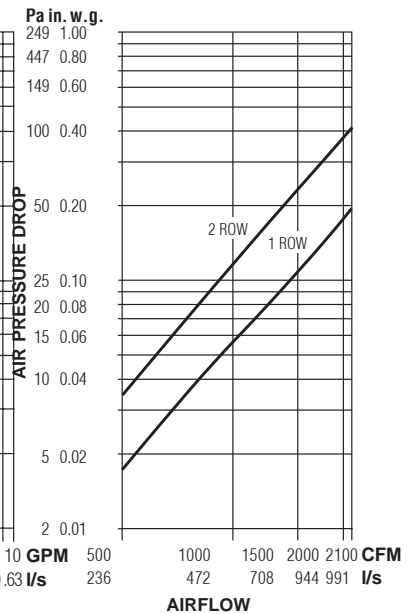

NOTES:

- Capacities are in MBH (kW), *thousands of Btu per hour (kiloWatts)*.
- MBH (kW) values are based on a Δt (temperature difference) of 120°F (67°C) between entering air and entering water. For other Δt 's; multiply the MBH (kW) values by the factors below.

- Air Temperature Rise.
 $ATR (^\circ F) = 927 \times \frac{MBH}{cfm}$, $ATR (^\circ C) = 829 \times \frac{kW}{l/s}$
- Water Temp. Drop.
 $WTD (^\circ F) = 2.04 \times \frac{MBH}{GPM}$, $WTD (^\circ C) = .224 \times \frac{kW}{l/s}$
- Connections: 1 Row 1/2" (13) and 2 Row 7/8" (22); O.D. male solder.

Altitude Correction Factors:

Altitude ft. (m)	Sensible Heat Factor
0 (0)	1.00
2000 (610)	0.94
3000 (914)	0.90
4000 (1219)	0.87
5000 (1524)	0.84
6000 (1829)	0.81
7000 (2134)	0.78

Correction factors at other entering conditions:

Δt °F (°C)	50 (28)	60 (33)	70 (39)	80 (44)	90 (50)	100 (56)	110 (61)	120 (67)	130 (72)	140 (78)	150 (83)
Factor	.417 (.418)	.500 (.493)	.583 (.582)	.667 (.657)	.750 (.746)	.833 (.836)	.917 (.910)	1.00 (1.00)	1.08 (1.08)	1.17 (1.16)	1.25 (1.24)

SERIES FLOW CONSTANT OR VARIABLE VOLUME

35S SERIES

- QUIET OPERATION

Models:

- 35S** No Heat
- 35SE** Electric Heat
- 35SW** Hot Water Heat

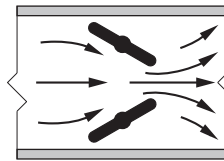
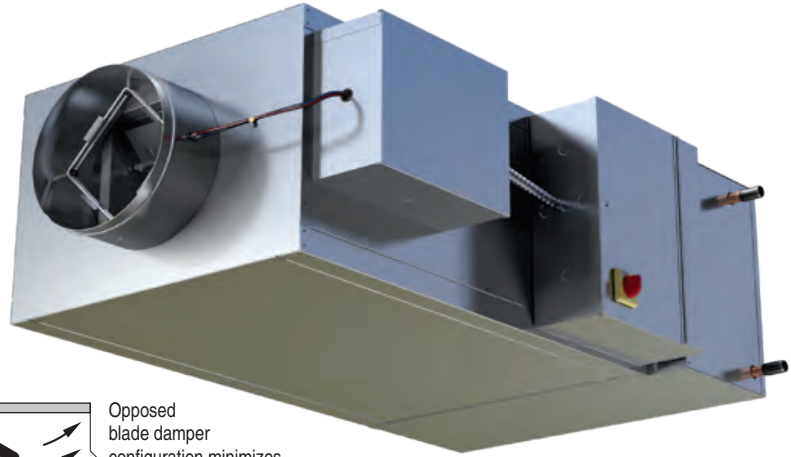

Opposed blade damper configuration minimizes noisy turbulence and provides smooth, accurate, near linear flow control.

Model 35SW

The **35S Series** provides many standard design features and superior sound performance when compared with other basic model designs. The 35S offers a compact and economical design well suited to the majority of applications.

STANDARD FEATURES:

- Unique 18 ga. (1.31) galvanized steel channel space frame construction provides extreme rigidity and 20 ga. (1.0) casing components.
- 16 ga. (1.61) galvanized steel inclined opposed blade primary air damper. 45° rotation, CW to close. 1/2" (13) dia. plated steel drive shaft. An indicator mark on the end of the shaft shows damper-position. Leakage is less than 2% of nominal flow at 3" w.g. (750 Pa).
- Perforated baffle on primary air discharge optimizes mixing with induced air for rapid and effective temperature equalization. The baffle also converts low frequency primary air valve generated sound into more readily attenuated higher frequencies.
- Pressure independent primary airflow control.
- Multi-point averaging Diamond Flow sensor.
- Terminal is field flippable, providing left or right installation connections. Refer to IOM for details.
- Universal access panels on all four sides of terminal for ease of maintenance and service.
- Energy efficient PSC fan motor with thermal overload protection.
- Motor blower assembly mounted on special 16 ga. (1.61) angles and isolated from casing with rubber isolators.
- Adjustable PSC solid state fan speed controller with minimum voltage stop.

- Hinged door on fan controls enclosure.
- 3/4" (19), dual density insulation. Exposed edges coated to prevent air erosion. Meets requirements of NFPA 90A and UL 181.
- Available with electric or hot water supplementary heat.
- All controls are mounted on exterior of terminal providing ready access for field adjustment.
- Each terminal factory tested prior to shipment.
- Single point electrical and/or pneumatic main air connection.
- Discharge opening designed for flanged duct connection.
- Full primary air valve low voltage NEMA 1 type enclosure for factory mounted DDC and analog electronic controls.

Controls:

- Nailor EZvav.
- Analog electronic and pneumatic controls. Factory supplied, mounted and calibrated.
- Digital controls. Factory mounting and wiring of DDC controls supplied by BMS Controls Contractor.

Options:

- ECM/EPIC Fan Technology®.
- Primary air valve enclosure for field mounted controls.

- Induced air filter, 1" (25) thick, disposable type.
- Toggle disconnect switch (except units with electric heat, when disconnect is an electric heat option and includes fan).
- Various IAQ linings are available.
- Fan airflow or P.E. switch for night shutdown (pneumatic controls).
- Fan airflow switch for night shutdown (analog electronic controls).
- Night setback fan/heat cycle (pneumatic and analog).
- Fan unit fusing.
- Hanger brackets.
- Q option induced air attenuator.
- Top entry induced air inlet.
- FN2 90° Line Voltage enclosure.
- FN3 Remote Line Voltage control enclosure.
- Low temperature construction (ice storage systems).



Intertek



Standard and Optional Features of the 35S

- **Electric Heat Option** High efficiency arrowhead insulators eliminate glow and extend element life. Manufactured in-house by Nailor. Removable element rack.



- **Hot Water Coils Option** for supplementary heat are mounted in an insulated plenum section for improved energy savings and heat transfer. Maintenance access panels on top and bottom sides are standard.

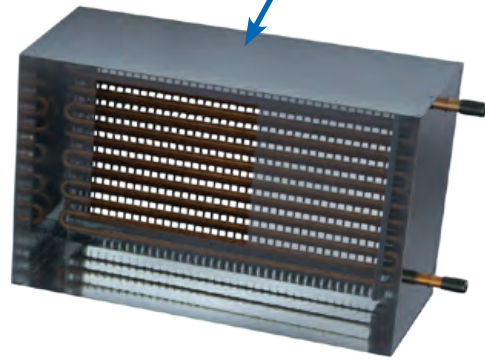

- **18 ga. (1.31) channel space frame construction.** Provides an extremely rigid terminal.

- **ECM Motor**
Factory pre-set air volume capability, 67% typical energy savings compared to PSC motors.

- **20 ga. (1.0) Removable Panels** on four sides provides access from above, beside or below.

- **Inclined Opposed Blade Primary Air Damper** minimizes noisy turbulence and ensures smooth accurate control

- **Multi-Point Diamond Flow Inlet Sensor** provides accurate primary air control.

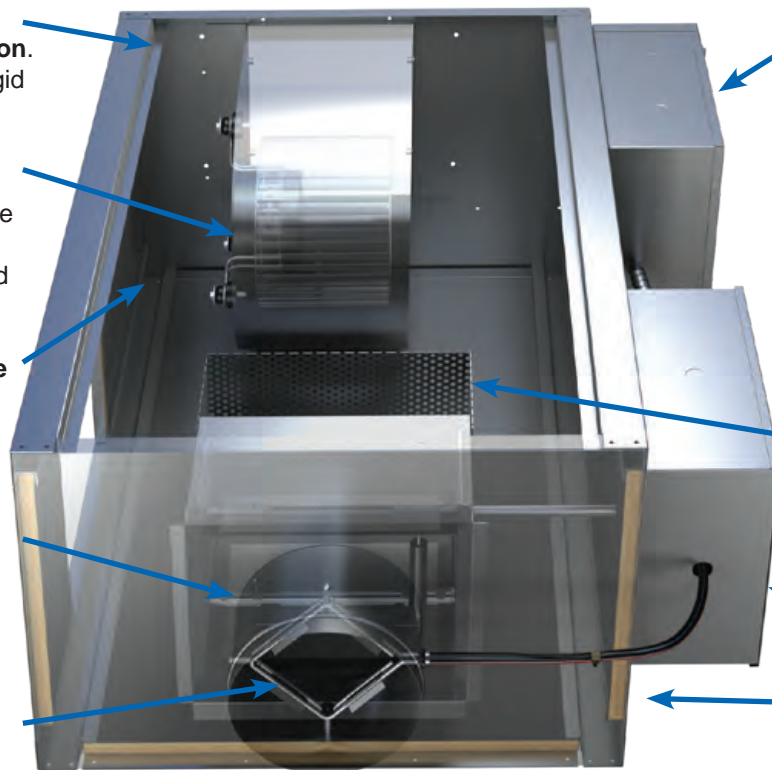

- **Line Voltage Enclosure**
Optional FN2 90° enclosure to comply with NEC clearance requirements



- **Perforated Diffusion Baffle** optimizes mixing of primary and induced airflows and improves sound performance.

- **24V Controls Enclosure**

- **3/4" (19) Dual Density Insulation** meets requirements of NFPA 90A and UL 181. Insulation with a high density skin, on the exposed side and a low density core.

- **'Q' Option** Induced Air Inlet Attenuator. This acoustically lined accessory is designed to deflect radiated sound upward and away from the ceiling, eliminating any direct sound path from the terminal to the occupied space. Radiated sound is diffused within the ceiling cavity and the decay that occurs as a result due to the ceiling plenum effect allows up to an additional 5 dB to be taken from radiated sound power levels.

A minimum clearance of 6" (152) must be provided above the unit, so that induced airflow is not impeded.

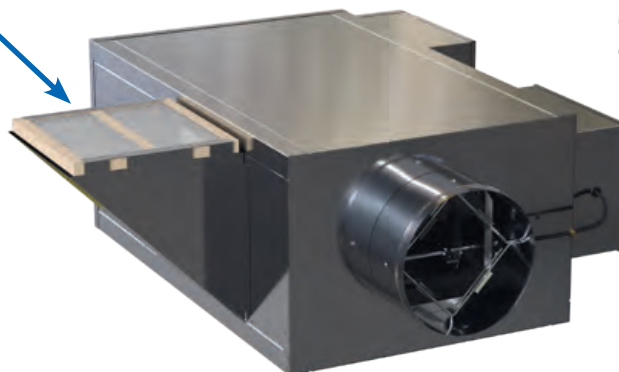

Dimensions

Model Series 35S • Series Flow • Unit Sizes 1 – 6

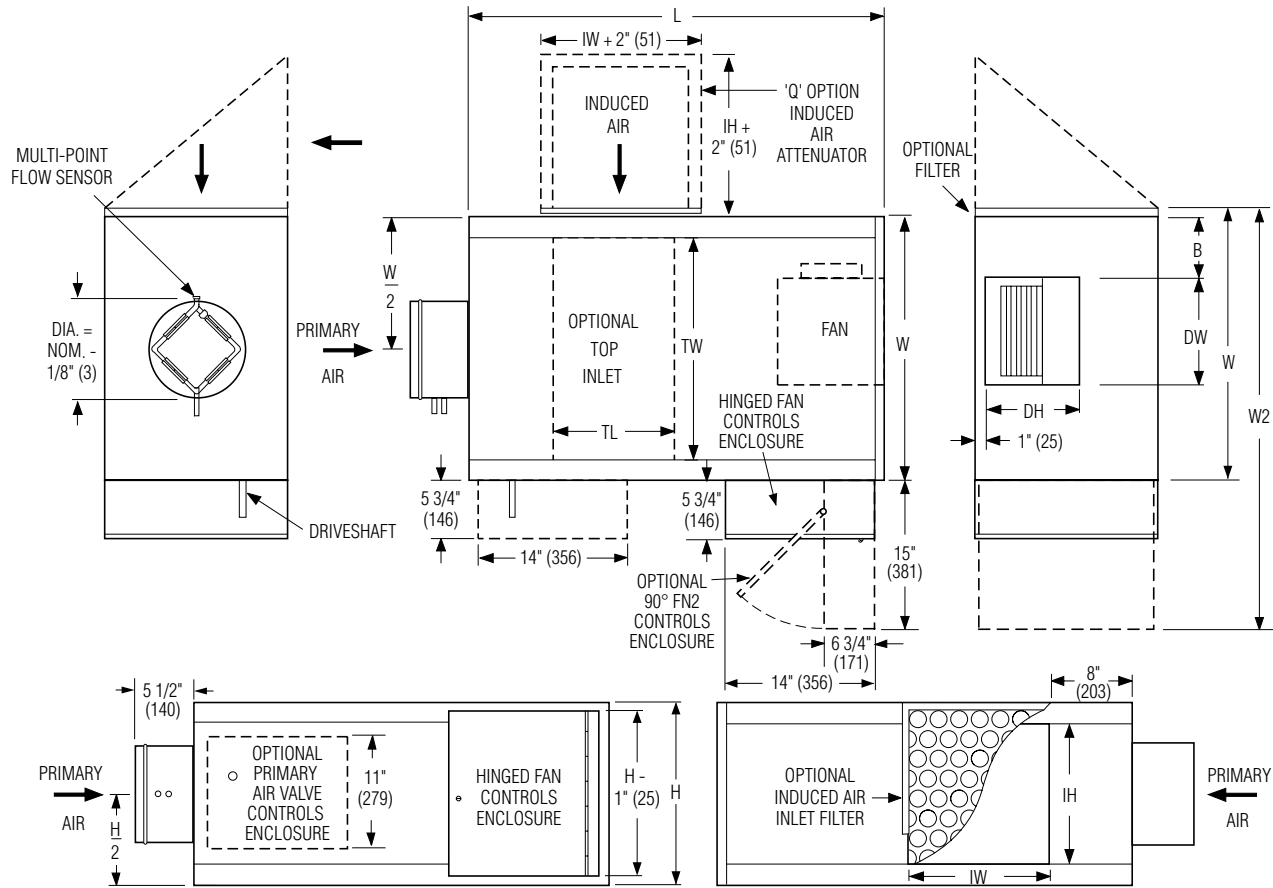

Dimensional Data

Unit Size	Inlet Size	W	W2	H	L	B	Induced Air Inlet		Outlet Discharge DW x DH	Filter Size	
							Side (std.) IW x IH	Top (opt.) TL x TW		Side Inlet (std.)	Top Inlet (opt.)
1	5, 6, 8** (127, 152, 203)	20 (508)	35 (889)	14 (356)	36 (914)	6 (152)	8 x 10 (203 x 254)	10 x 14 (254 x 356)	8 1/8 x 4 1/4 (206 x 108)	10 x 12 (254 x 305)	14 x 16 (356 x 406)
2	6, 8 (152, 203)	18 (457)	33 (838)	14 (356)	36 (914)	3 1/2 (89)	8 x 10 (203 x 254)	10 x 14 (254 x 356)	9 1/4 x 10 1/2 (235 x 267)	10 x 12 (254 x 305)	14 x 16 (356 x 406)
3	6, 8, 10, 12 (152, 203, 254, 305)	18 (457)	33 (838)	18 (457)	36 (914)	3 1/2 (89)	12 x 14 (305 x 356)	14 x 14 (356 x 356)	9 1/4 x 10 1/2 (235 x 267)	14 x 16 (356 x 406)	16 x 16 (406 x 406)
4	8, 10, 12, 14 (203, 254, 305, 356)	26 (660)	41 (1041)	18 (457)	41 (1041)	6 (152)	14 x 14 (356 x 356)	12 x 22 (305 x 559)	12 x 10 1/2 (305 x 267)	16 x 16 (406 x 406)	16 x 25 (406 x 635)
5	10, 12, 14 (254, 305, 356)	26 (660)	41 (1041)	18 (457)	41 (1041)	5 (127)	14 x 14 (356 x 356)	12 x 22 (305 x 559)	13 1/4 x 11 1/2 (337 x 292)	16 x 16 (406 x 406)	16 x 25 (406 x 635)
6	12, 14, 16 (305, 356, 406)	30 (762)	45 (1143)	19 (483)	44 (1118)	6 (152)	16 x 15 (406 x 381)	14 x 26 (356 x 660)	13 1/4 x 11 1/2 (337 x 292)	17 x 18 (432 x 457)	18 x 28 (457 x 711)

** ECM Only.

Dimensions

Model Series 35S • Unit Size 7

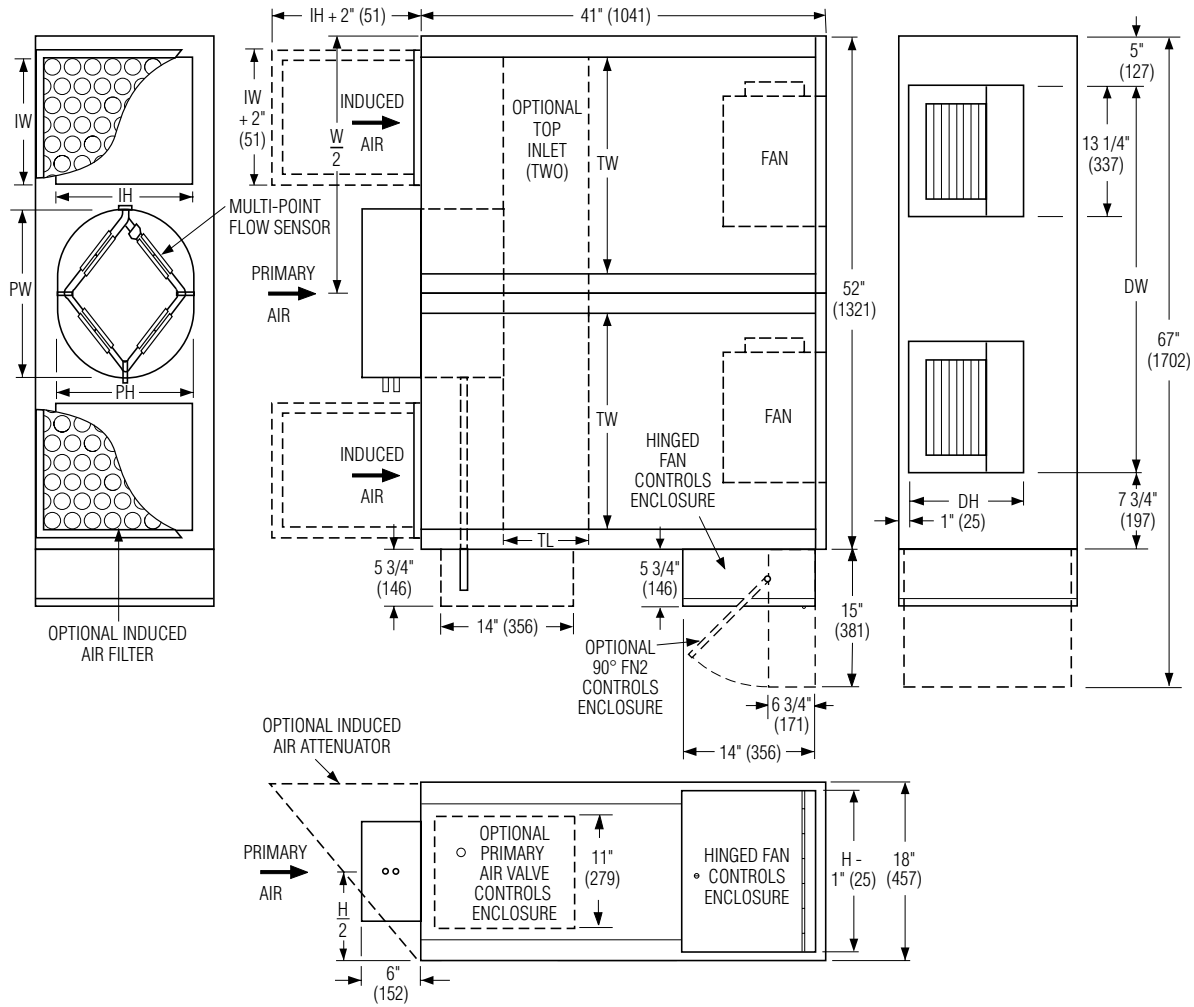

Dimensional Data

Unit Size	Inlet		Induced Air Inlet		Outlet Discharge DW x DH	Filter Size	
	Size	PW x PH	Side (std.) IW x IH	Top (opt.) TL x TW		Side Inlet (std.)	Top Inlet (opt.)
7	14 (356) Rd.	13 7/8 (352)	12 x 14 (305 x 356)	8 1/2 x 20 (216 x 508)	39 1/4 x 11 1/2 (997 x 292)	14 x 16 (356 x 406)	16 x 25 (406 x 635)
	16 (406) Rd.	15 7/8 (403)					
	18 (457) Oval	20 3/16 x 13 7/8 (513 x 352)					

Dimensions

Model Series 35S • Series Flow

Hot Water Coil Section

Model 35SW

Available in one, two or three row. Coil section installed on unit discharge. Right hand coil connection looking in direction of airflow standard (shown). Left hand is optional.

Standard Features:

- Coil section installed on unit discharge.
- Coil (and header on multi-circuit units) is installed in insulated casing for increased thermal efficiency.
- 1/2" (13) copper tubes.
- Aluminum ripple fins.
- Sweat Connections:
Size 1 – 3: 1 Row 1/2" (13), 2 and 3 Row 7/8" (22); O.D. male solder.
Size 4 – 6: 1, 2, and 3 Row 7/8" (22); O.D. male solder.
Size 7: 1 and 2 Row 7/8" (22), 3 Row 1 3/8" (35) O.D. male solder.
- Top and bottom access panels for inspection and coil cleaning.
- Flanged outlet duct connection.

Unit Sizes 1 – 6

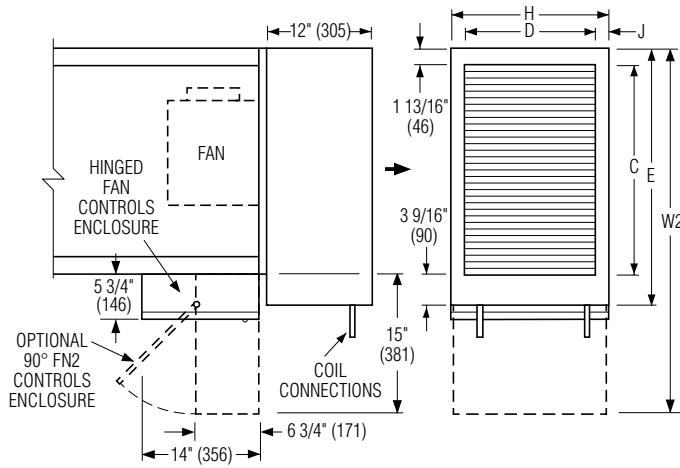

Unit Size 7

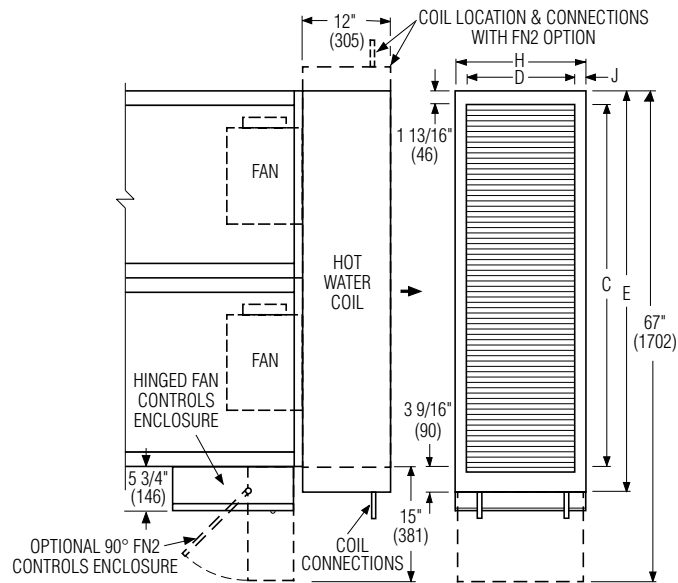

Unit Size	Outlet Duct Size C x D	W2	E	H	J
1	16 x 12 1/8 (406 x 308)	35 (889)	21 3/8 (543)	14 (356)	1 (25)
2	16 x 12 1/8 (406 x 308)	33 (838)	21 3/8 (543)	14 (356)	1 (25)
3	16 x 14 7/8 (406 x 378)	33 (838)	21 3/8 (543)	18 (457)	1 1/2 (38)
4, 5	24 x 14 7/8 (610 x 378)	41 (1041)	29 3/8 (746)	18 (457)	1 1/2 (38)
6	28 x 17 1/8 (711 x 435)	45 (1143)	33 3/8 (848)	19 (483)	1 (25)
7	50 x 14 7/8 (1270 x 378)	—	55 3/8 (1407)	18 (457)	1 9/16 (40)



Dimensions

Model Series 35S • Series Flow

Electric Coil Section

Model 35SE

Standard Features:

- Unique hinged heater design permits easy access, removal and replacement of heater element without disturbing ductwork.
- Coil installed on unit discharge.
- Insulated coil element wrapper.
- Automatic reset high limit cut-outs (one per element).
- Single point electrical connection for entire terminal unit.
- Magnetic contactors per stage.
- Class A 80/20 Ni/Cr wire.
- Positive pressure airflow switch.
- Flanged outlet duct connection.
- Terminal unit with coil is ETL Listed as an assembly.
- Controls mounted as standard on RH side as shown. Terminals ordered with LH controls (optional) are inverted and discharge duct hanging elevation will therefore change.

Standard Supply Voltage (60 Hz):

- Single phase: 120, 208, 240 & 277V.
- Three phase: 208, 480 (4 wire wye) and 600V (dual point connection).

Options:

- SCR control.
- SCR control with discharge temperature control.
- Toggle disconnect switch (includes fan).
- Door interlock disconnect switch.
- Mercury contactors.
- Power circuit fusing.
- Dust tight construction.
- Manual reset secondary thermal cut out.

Unit Sizes 1 – 6

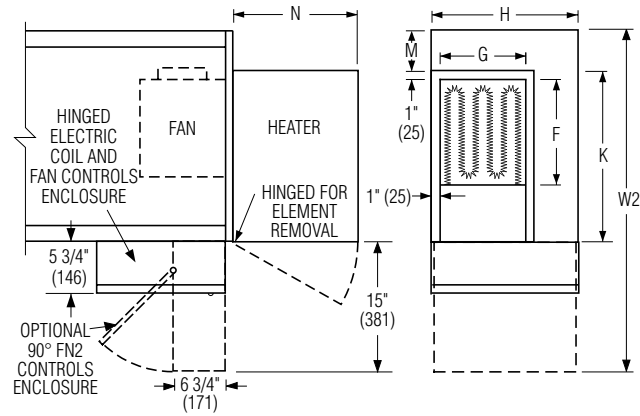

Unit Size 7

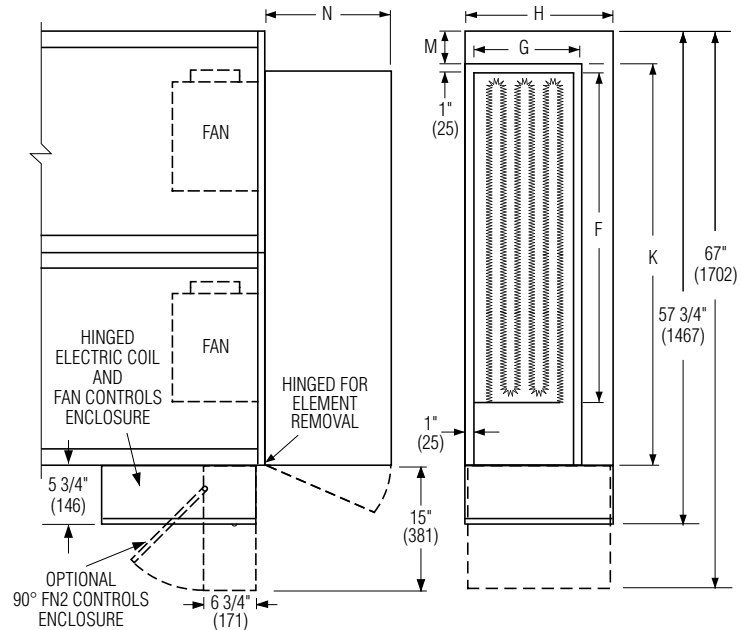

Unit Size	Outlet Duct Size F x G	W2	K	H	M	N
1	10 1/4 x 10 1/2 (260 x 267)	35 (889)	16 (406)	14 (356)	4 (102)	12 1/2 (318)
2	10 1/4 x 10 1/2 (260 x 267)	33 (838)	15 1/2 (394)	14 (356)	2 1/2 (64)	12 1/2 (318)
3	10 1/4 x 10 1/2 (260 x 267)	33 (838)	15 1/2 (394)	18 (457)	2 1/2 (64)	15 1/4 (387)
4	13 x 10 1/2 (330 x 267)	41 (1041)	21 (533)	18 (457)	5 (127)	15 1/4 (387)
5	14 1/4 x 11 3/4 (362 x 298)	41 (1041)	22 (559)	18 (457)	4 (102)	15 1/4 (387)
6	14 1/4 x 11 3/4 (362 x 298)	45 (1143)	25 (635)	19 (483)	5 (127)	15 1/4 (387)
7	40 1/4 x 11 3/4 (1022 x 298)	—	48 (1219)	18 (457)	4 (102)	15 1/4 (387)

Performance Data

PSC Motor Fan Curves – Airflow vs. Downstream Static Pressure

35S Series • Series Flow

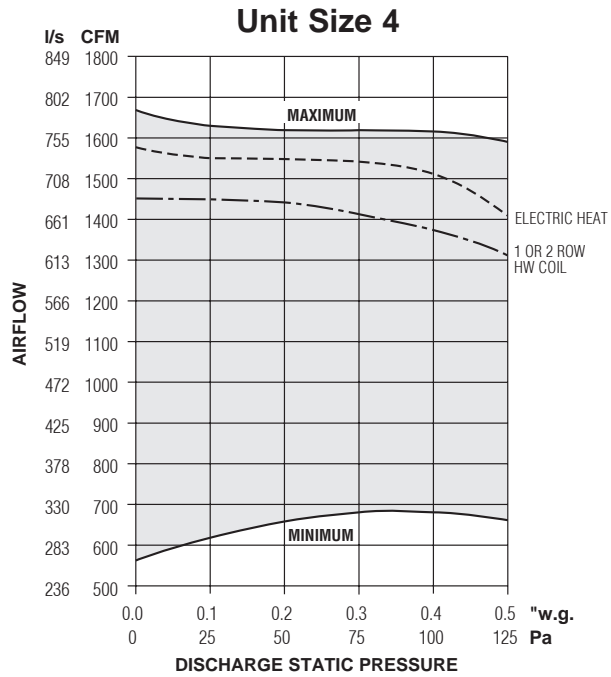
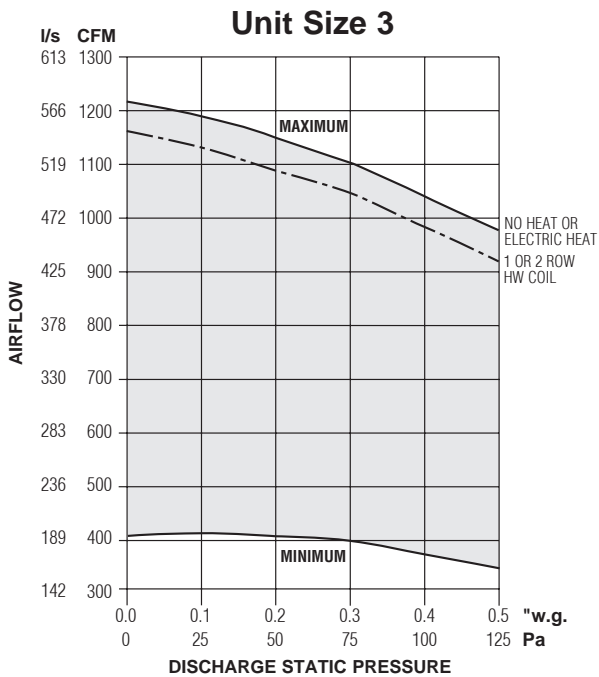
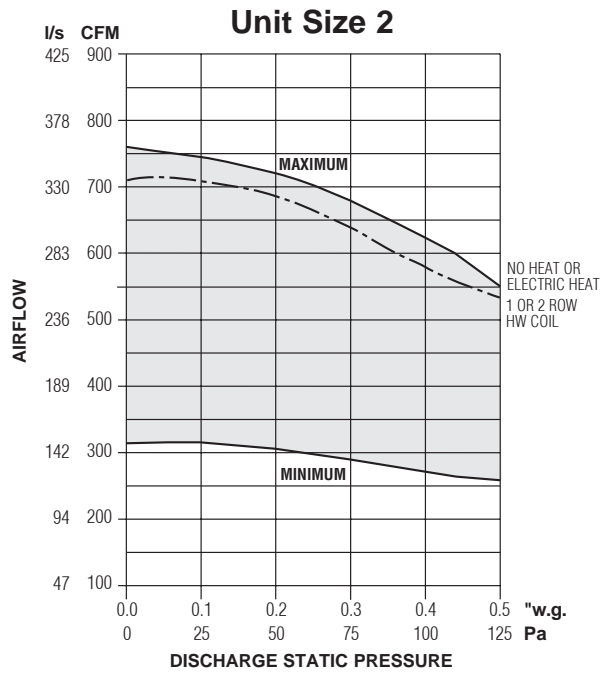
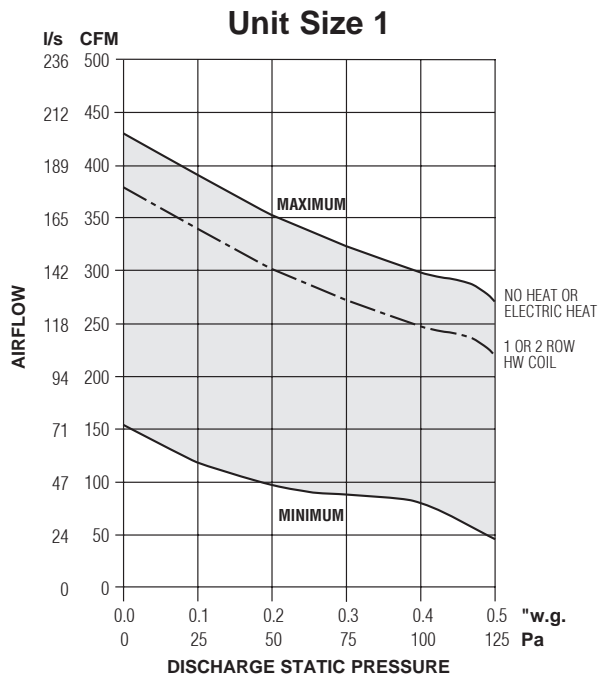

- Fan Curves shown are applicable to 120, 208, 240 and 277 volt, single phase PSC motors.

Electrical Data

Unit Size	PSC Motor FLA	PSC Motor FLA			
		Motor HP	120V	208V	240V
1	1/10	3.0	2.0	2.0	0.9
2	1/10	3.3	2.0	2.0	1.0
3	1/4	5.8	3.6	3.6	1.8
4	1/3	6.2	4.1	4.1	2.0

FLA = Full load amperage.
All motors are single phase/60 Hz.



Performance Data

PSC Motor Fan Curves – Airflow vs. Downstream Static Pressure

35S Series • Series Flow

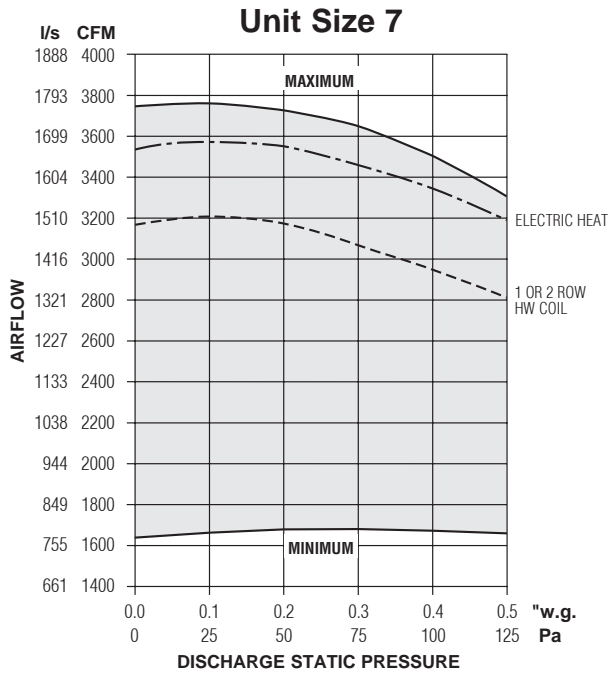
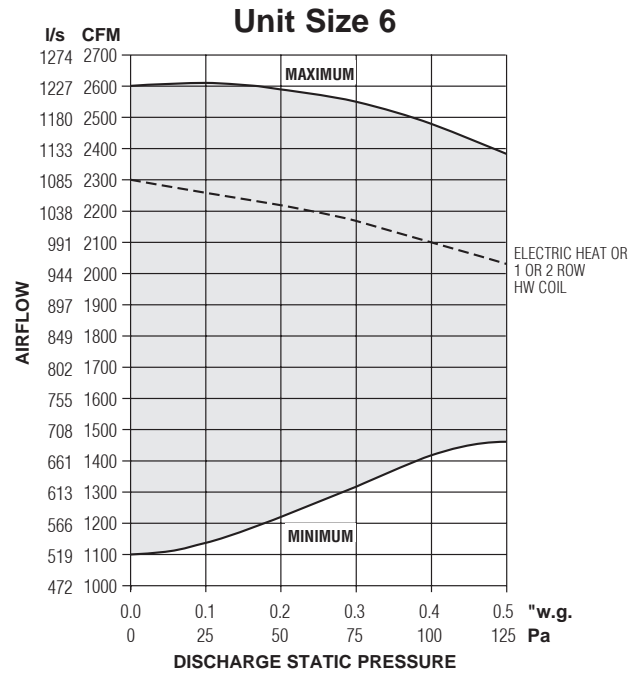
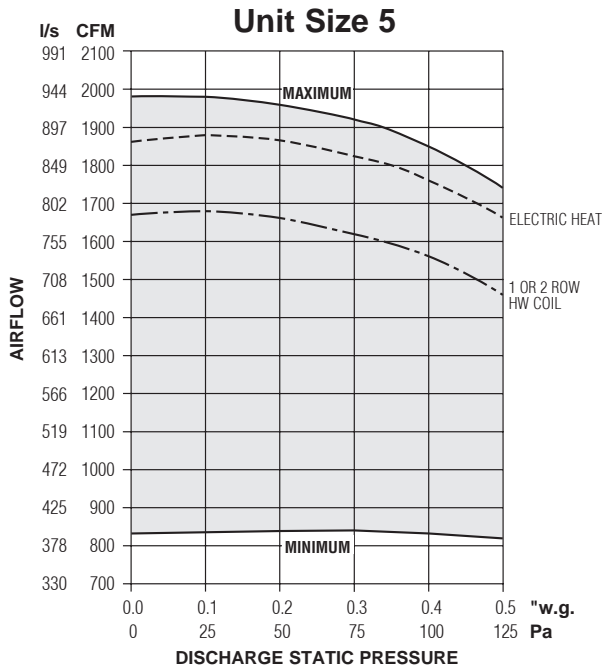

- Fan Curves shown are applicable to 120, 208, 240 and 277 volt, single phase PSC motors.

Electrical Data

Unit Size	PSC Motor FLA				
	Motor HP	120V	208V	240V	277V
5	1/2	10.1	6.5	6.5	3.3
6	3/4	13.4	8.4	8.4	4.5
7	2@1/2	20.2	13.0	13.0	6.6

FLA = Full load amperage.
All motors are single phase/60 Hz.

Performance Data

ECM Motor Fan Curves – Airflow vs. Downstream Static Pressure

35S Series • Series Flow

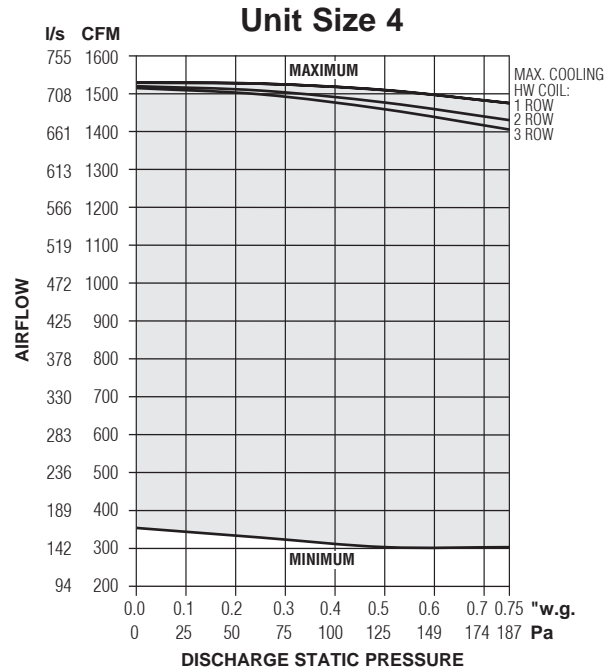
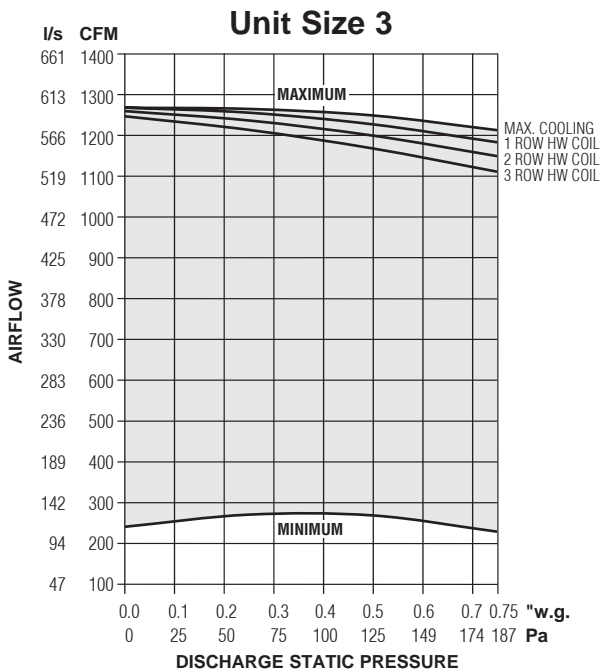
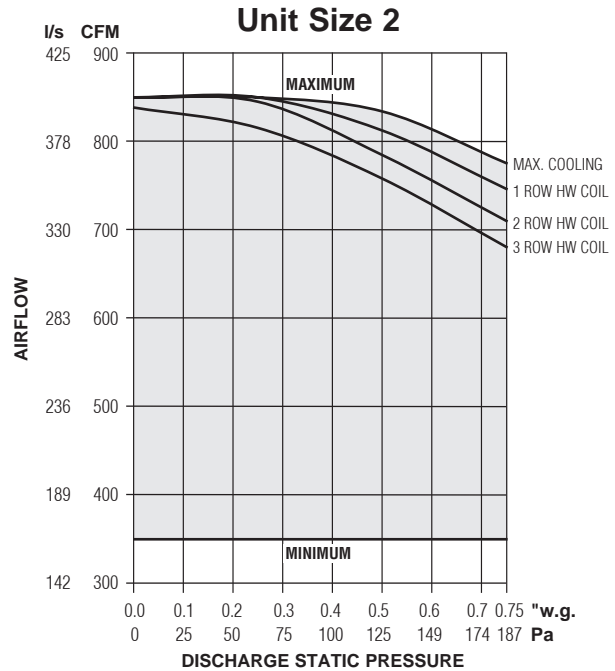
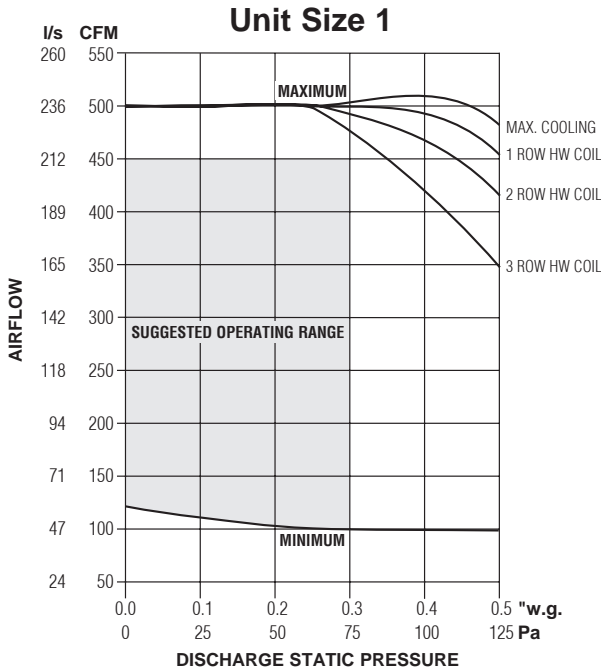

Electrical Data

Unit Size	EPIC ECM Motor FLA				
	Motor HP	120V	208V	240V	277V
1	*	2.1	1.4	1.30	1.2
2	*	4.0	2.7	2.6	2.6
3	*	5.0	3.4	3.3	3.3
4	*	6.9	4.6	4.5	4.2

* The EPIC ECM is a variable horsepower motor. Refer to Selectworks schedule for actual power consumption.

FLA = Full load amperage.

All motors are single phase/60 Hz.

NOTES:

- The ECM is pressure independent and constant volume in operation at factory or field set point within the shaded area. Airflow does not vary with changing static pressure conditions. The motor compensates for any changes in external static pressure or induced air conditions such as filter loading.
- Airflow can be set to operate on horizontal performance line at any point within shaded area using the solid state volume controller provided.
- Fan curves shown are applicable to 120, 208, 240 and 277 volt, single phase ECM's. ECM's, although DC in operation, include a built-in AC/DC converter.



Performance Data

ECM Motor Fan Curves – Airflow vs. Downstream Static Pressure

35S Series • Series Flow

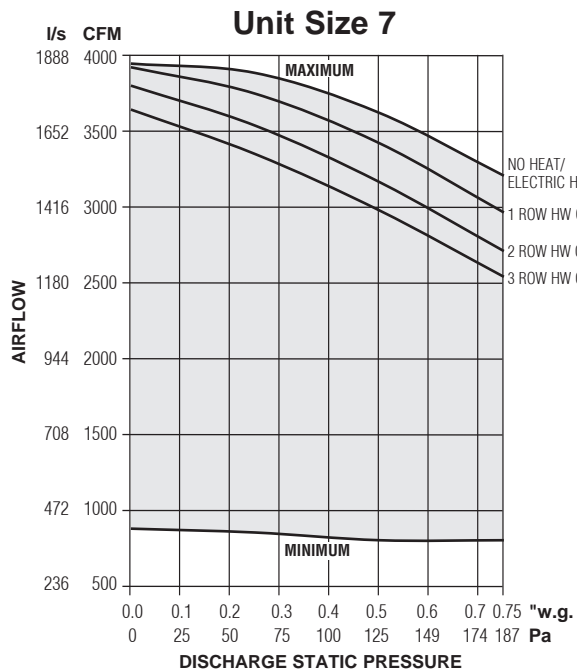
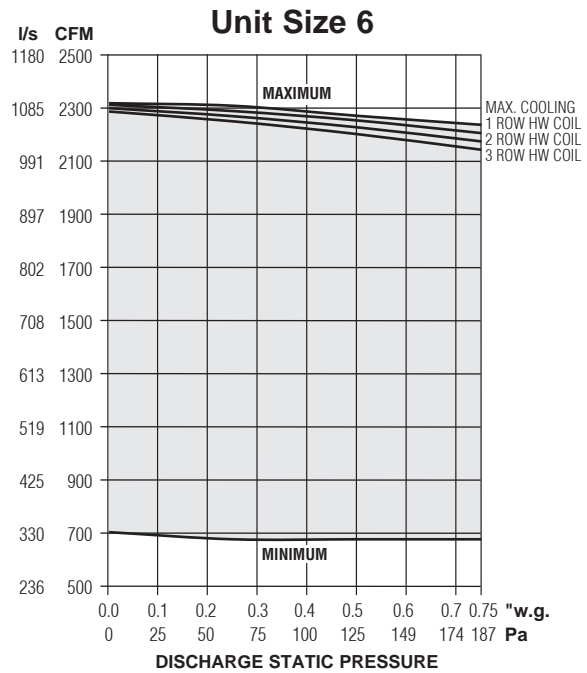
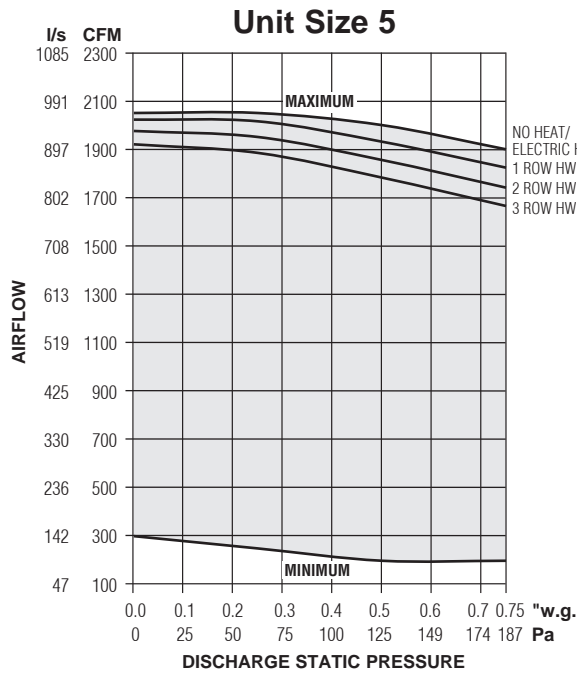

Electrical Data

Unit Size	EPIC ECM Motor FLA				
	Motor HP	120V	208V	240V	277V
5	*	9.0	6.1	5.8	5.6
6	*	11.9	7.3	7.3	7.2
7	*	15.9	10.5	9.9	10.0

* The EPIC ECM is a variable horsepower motor. Refer to Selectworks schedule for actual power consumption.

FLA = Full load amperage. All motors are single phase/60 Hz.

NOTES:

- The ECM is pressure independent and constant volume in operation at factory or field set point within the shaded area. Airflow does not vary with changing static pressure conditions. The motor compensates for any changes in external static pressure or induced air conditions such as filter loading.
- Airflow can be set to operate on horizontal performance line at any point within shaded area using the solid state volume controller provided.
- Fan curves shown are applicable to 120, 208, 240 and 277 volt, single phase ECM's. ECM's, although DC in operation, include a built-in AC/DC converter.

Performance Data • NC Level Application Guide

Model Series 35S • Series Flow • Basic Unit

Fiberglass Liner

Unit Size	Inlet Size	Airflow		Min. inlet ΔPs		NC Levels @ Inlet Pressure (ΔPs) shown												
						DISCHARGE						RADIATED						
						Fan Only	Min. ΔPs	0.5 w.g. (125 Pa)	1.0" w.g. (250 Pa)	1.5" w.g. (375 Pa)	2.0" w.g. (500 Pa)	Fan Only	Min. ΔPs	0.5" w.g. (125 Pa)	1.0" w.g. (250 Pa)	1.5" w.g. (375 Pa)	2.0" w.g. (500 Pa)	
1	6	550	260	0.22	54	37	36	36	36	39	39	36	36	35	36	37	37	
		400	189	0.12	30	30	26	26	29	30	33	30	30	30	31	33	33	
		300	142	0.07	17	20	-	20	25	29	29	25	25	26	28	29	30	
		200	94	0.04	9	-	-	-	20	20	20	-	-	-	22	24	25	
		100	47	0.01	3	-	-	-	-	-	-	-	-	-	-	-	21	
	8	550	260	0.06	15	37	35	35	35	38	38	36	36	35	36	37	37	
		400	189	0.03	8	30	26	26	28	29	31	30	30	30	31	33	33	
		300	142	0.02	5	20	-	-	24	26	28	25	24	25	28	29	30	
		200	94	0.01	2	-	-	-	-	-	-	-	-	-	21	23	24	
		100	47	0.01	1	-	-	-	-	-	-	-	-	-	-	-	20	
2	6	550	260	0.20	50	23	25	28	29	31	33	24	23	25	29	32	33	
		400	189	0.11	27	-	-	-	24	28	29	-	-	21	24	29	30	
		200	94	0.04	10	-	-	-	-	-	-	-	-	-	22	25	28	
	8	850	401	0.11	28	31	34	36	34	35	36	35	33	34	35	36	36	
		700	330	0.08	19	28	30	34	31	34	35	28	30	30	33	34	35	
		550	260	0.05	12	23	24	26	26	30	31	24	23	24	28	31	33	
		400	189	0.02	6	-	-	-	21	25	26	-	-	20	24	28	30	
		200	94	0.01	2	-	-	-	-	-	-	-	-	-	21	24	26	
	3	6	550	260	0.20	50	23	25	25	28	30	31	26	28	29	32	34	34
			400	189	0.11	27	-	-	-	21	23	24	21	22	23	25	29	29
8		1100	519	0.12	30	31	31	31	33	35	36	34	34	34	36	38	38	
		900	425	0.08	20	26	28	28	30	33	34	30	31	32	34	36	36	
		700	330	0.05	12	23	24	24	26	30	30	26	28	29	31	34	34	
		400	189	0.02	5	-	-	-	-	20	21	21	22	23	25	29	29	
10		1215	573	0.03	7	34	34	34	35	36	36	35	34	35	37	38	38	
		1100	519	0.03	7	31	30	31	33	34	35	34	33	34	36	37	37	
		900	425	0.02	4	26	25	26	28	30	33	30	30	31	33	35	35	
		700	330	0.01	2	23	21	23	24	28	28	26	26	28	31	33	33	
400	189	0.01	1	-	-	-	-	-	-	21	21	22	24	28	28			
4	10	1550	731	0.10	25	39	37	39	41	43	44	35	35	37	39	41	43	
		1400	661	0.08	19	35	34	36	38	39	41	33	33	35	37	40	41	
		1200	566	0.05	13	31	29	33	35	37	38	30	30	33	36	39	40	
		900	425	0.03	7	25	25	28	29	30	31	25	25	30	32	35	36	
		700	330	0.02	4	21	23	25	24	26	28	22	22	26	30	33	34	
	12	1550	731	0.05	12	39	36	38	40	41	43	35	35	37	39	41	43	
		1400	661	0.03	8	35	33	35	37	38	40	33	33	35	37	40	41	
		1200	566	0.02	5	31	29	33	35	36	38	30	30	33	35	38	39	
		900	425	0.01	3	25	23	26	26	29	30	25	25	29	32	34	36	
		700	330	0.01	2	21	21	23	23	24	25	22	21	26	29	32	33	
5	12	2050	967	0.06	15	39	38	39	41	43	43	40	38	39	40	41	43	
		1850	873	0.05	12	36	35	36	38	39	40	38	36	37	38	39	40	
		1600	755	0.04	10	33	31	34	35	37	38	34	34	35	36	38	38	
		1350	637	0.03	7	28	26	30	31	34	35	29	30	31	34	36	37	
		1100	519	0.02	5	23	24	26	29	30	30	26	25	28	30	33	34	
	14	2050	967	0.04	10	39	37	38	40	41	41	40	38	39	40	41	43	
		1850	873	0.03	8	36	34	36	37	38	39	38	36	37	38	39	40	
		1600	755	0.03	7	33	30	33	35	36	37	34	34	35	36	38	38	
		1350	637	0.02	5	28	26	29	30	33	34	29	29	30	34	36	37	
		1100	519	0.01	3	23	21	25	26	28	28	26	25	28	30	33	34	
6	14	2400	1133	0.08	20	40	38	39	41	43	43	43	39	41	44	46	46	
		2100	991	0.06	15	37	36	37	39	40	40	40	37	38	41	44	44	
		1700	802	0.04	10	31	29	33	34	36	36	36	33	34	37	40	40	
		1400	661	0.03	6	26	25	27	29	30	30	33	28	29	34	37	37	
7	16	4000	1888	0.15	38	40	38	39	41	43	44	46	44	44	45	46	47	
		3500	1652	0.12	29	37	35	36	38	40	41	43	40	41	43	45	45	
		2800	1321	0.08	19	31	30	33	35	37	35	38	36	37	39	41	43	
		2100	991	0.04	11	25	24	26	29	29	30	34	33	33	35	38	40	
		1600	755	0.03	6	21	-	23	24	24	26	30	28	30	33	36	38	
	18	4000	1888	0.10	25	40	38	38	40	41	43	46	44	44	45	46	47	
		3500	1652	0.07	18	37	35	35	38	39	40	43	40	41	43	45	45	
		2800	1321	0.05	11	31	29	31	34	36	35	38	36	37	39	41	41	
		2100	991	0.02	5	25	21	25	28	28	28	34	33	33	35	38	39	
		1600	755	0.02	4	21	-	20	21	21	24	30	28	29	32	36	37	

Performance Notes: 1. NC Levels are calculated based on procedures as outlined on page C160.

2. Dash (-) in space indicates a NC less than 20.

FAN POWERED TERMINAL UNITS

Performance Data • Discharge Sound Power Levels

Model Series 35S • Series Flow • Basic Unit

Fiberglass Liner



Unit Size	Inlet Size	Airflow		Min. inlet ΔPs		Fan Only		Fan and 100% Primary Air—Sound Power Octave Bands @ Inlet pressure (ΔPs) shown																																	
								Minimum ΔPs					0.5" w.g. (125Pa) ΔPs					1.0" w.g. (249Pa) ΔPs					1.5" w.g. (375Pa) ΔPs					2.0" w.g. (500Pa) ΔPs													
								2	3	4	5	6	7	2	3	4	5	6	7	2	3	4	5	6	7	2	3	4	5	6	7	2	3	4	5	6	7				
1	6	550	260	0.22	54	79	76	71	69	66	63	78	75	69	67	64	62	78	75	69	67	64	61	78	75	70	68	64	62	80	78	71	69	65	63	79	78	71	69	65	63
		400	189	0.12	30	74	70	66	64	60	57	70	67	63	60	56	53	70	67	62	60	56	53	71	69	63	60	57	53	72	70	64	60	57	54	72	72	65	60	57	54
		300	142	0.07	17	67	62	59	55	50	46	65	61	56	53	48	44	67	62	57	54	49	45	69	66	59	55	50	46	71	69	61	56	51	48	71	69	62	57	52	49
		200	94	0.04	9	58	52	47	-	-	-	58	51	45	-	-	-	58	52	45	41	-	-	64	59	50	44	38	33	64	60	55	48	42	38	64	61	55	48	43	39
		100	47	0.01	3	57	44	34	-	-	-	56	44	35	-	-	-	57	47	37	28	-	-	58	49	42	32	25	24	58	50	47	35	29	28	59	50	48	37	31	30
	8	550	260	0.06	15	79	76	71	69	66	63	77	74	68	67	64	62	77	74	68	67	64	61	77	74	69	68	64	62	79	77	70	69	65	63	78	77	70	69	65	63
		400	189	0.03	8	74	70	66	64	60	57	69	67	63	59	56	53	69	67	62	59	56	53	70	68	63	59	57	53	71	69	63	59	57	54	71	71	64	60	57	54
		300	142	0.02	5	67	62	59	55	50	46	63	60	55	52	48	44	65	61	56	53	49	45	67	65	58	54	50	46	69	67	60	55	51	48	69	68	61	56	52	49
		200	94	0.01	2	58	52	47	-	-	-	56	49	44	-	-	-	56	50	45	40	-	-	62	58	49	43	37	33	62	58	54	47	41	38	62	60	54	47	42	39
		100	47	0.01	1	57	44	34	-	-	-	54	43	34	-	-	-	55	46	36	28	-	-	56	48	41	31	25	23	56	49	45	34	29	28	57	49	47	36	31	29
2	6	550	260	0.20	50	66	64	61	58	55	52	70	66	62	58	54	51	72	68	62	59	55	52	72	69	62	58	54	50	74	71	63	58	54	51	75	72	63	58	54	52
		400	189	0.11	27	63	60	57	54	50	45	63	60	56	52	48	42	64	61	56	52	48	42	69	65	57	52	48	43	71	68	58	53	48	44	71	69	59	53	48	45
		200	94	0.04	10	57	52	48	44	37	28	58	52	46	42	34	26	62	55	47	42	35	27	62	55	47	42	35	27	63	59	51	44	37	32	63	59	52	45	38	33
		850	401	0.11	28	74	72	67	68	64	63	76	74	68	67	64	62	78	76	70	68	65	63	76	74	68	66	63	61	77	75	68	66	63	61	78	76	68	66	63	61
		700	330	0.08	19	70	68	64	63	60	57	73	70	65	63	60	57	76	73	67	65	62	59	73	71	64	62	59	56	75	73	65	62	59	57	76	74	65	62	59	57
	8	550	260	0.05	12	66	64	61	58	55	52	68	65	60	58	54	51	70	67	61	59	55	52	70	67	61	57	54	50	72	70	61	58	54	51	73	71	62	58	54	52
		400	189	0.02	6	63	60	57	54	50	45	61	58	55	52	47	42	63	60	55	51	47	42	67	63	56	52	47	42	69	66	57	52	48	44	69	67	58	52	48	44
		200	94	0.01	2	57	52	48	44	37	28	56	50	45	41	34	26	59	53	46	41	34	27	60	57	48	42	36	29	61	58	50	43	36	31	60	57	50	44	37	33
		850	401	0.11	28	74	72	67	68	64	63	76	74	68	67	64	62	78	76	70	68	65	63	76	74	68	66	63	61	77	75	68	66	63	61	78	76	68	66	63	61
		700	330	0.08	19	70	68	64	63	60	57	73	70	65	63	60	57	76	73	67	65	62	59	73	71	64	62	59	56	75	73	65	62	59	57	76	74	65	62	59	57
3	6	550	260	0.20	50	66	64	63	59	55	51	68	66	64	59	54	49	69	66	65	60	54	50	73	68	65	60	54	50	73	70	65	60	54	51	75	71	65	60	54	51
		400	189	0.11	27	62	56	55	51	45	36	65	59	57	51	45	36	65	60	57	51	46	36	68	63	57	51	46	37	68	64	58	51	46	39	69	65	58	52	46	40
		1100	519	0.12	30	73	72	71	69	65	63	73	72	71	68	64	62	73	72	71	69	64	62	75	73	71	69	64	62	76	75	71	69	64	62	76	76	71	68	64	62
		900	425	0.08	20	70	68	67	64	60	58	69	69	68	64	59	56	71	69	68	64	60	57	72	71	68	64	60	57	74	73	68	64	60	57	74	74	68	64	60	57
		700	330	0.05	12	66	64	63	59	55	51	66	65	63	59	54	50	67	65	64	59	55	50	70	67	64	59	55	51	71	70	64	59	55	51	72	70	64	59	55	51
	8	550	260	0.05	12	66	64	61	58	55	52	68	65	60	58	54	51	70	67	61	59	55	52	70	67	61	57	54	50	72	70	61	58	54	51	73	71	62	58	54	52
		400	189	0.02	6	63	60	57	54	50	45	61	58	55	52	47	42	63	60	55	51	47	42	67	63	56	52	47	42	69	66	57	52	48	44	69	67	58	52	48	44
		200	94	0.01	2	57	52	48	44	37	28	56	50	45	41	34	26	59	53	46	41	34	27	60	57	48	42	36	29	61	58	50	43	36	31	60	57	50	44	37	33
		850	401	0.11	28	74	72	67	68	64	63	76	74	68	67	64	62	78	76	70	68	65	63	76	74	68	66	63	61	77	75	68	66	63	61	78	76	68	66	63	61
		700	330	0.08	19	70	68	64	63	60	57	73	70	65	63	60	57	76	73	67	65	62	59	73	71	64	62	59	56	75	73	65	62	59	57	76	74	65	62	59	57
4	6	550	260	0.20	50	66	64	63	59	55	51	68	66	64	59	54	49	69	66	65	60	54	50	73	68	65	60	54	50	73	70	65	60	54	51	75	71	65	60	54	51
		400	189	0.11	27	62	56	55	51	45	36	65	59	57	51	45	36	65	60	57	51	46	36	68	63	57	51	46	37	68	64	58	51	46	39	69	65	58	52	46	40
		1100	519	0.12	30	73	72	71	69	65	63	73	72	71	68	64	62	73	72	71	69	64	62	75	73	71	69	64	62	76	75	71	69	64	62	76	76	71	68	64	62
		900	425	0.08	20	70	68	67	64	60	58	69	69	68	64	59	56	71	69	68	64	60	57	72	71	68	64	60	57	74	73	68	64	60	57	74	74	68	64	60	57
		700	330	0.05	12	66	64	63	59	55	51	66	65	63	59	54	50	67	65	64	59	55	50	70	67	64	59	55	51	71	70	64	59	55	51	72	70	64	59	55	51
	8	550	260	0.05	12	66	64	61	58	55	52	68	65	60	58	54	51	70	67	61	59	55	52	70	67	61	57	54	50	72	70	61	58	54	51	73	71	62	58	54	52
		400	189	0.02	6	63	60	57	54	50	45	61	58	55	52	47	42	63	60	55	51	47	42	67	63	56	52	47	42	69	66	57	52	48	44	69	67	58	52	48	44
		200	94	0.01	2	57	52	48	44	37	28	56	50	45	41	34	26	59	53	46	41	34	27	60	57	48	42	36	29	61	58	50	43	36	31	60	57	50	44	37	33
		850	401	0.11	28	74	72	67	68	64	63	76	74	68	67	64	62	78	76	70	68	65	63	76	74	68	66	63	61	77	75	68	66	63	61	78	76	68	66	63	61
		700	330	0.08	19	70	68	64	63	60	57	73	70	65	63	60	57	76	73	67	65	62	59	73	71	64	62	59	56	75</											

Performance Data • Radiated Sound Power Levels

Model Series 35S • Series Flow • Basic Unit

Fiberglass Liner



Unit Size	Inlet Size	Airflow		Min. inlet ΔPs		Fan Only		Fan and 100% Primary Air-Sound Power Octave Bands @ Inlet pressure (ΔPs) shown																																		
								Minimum ΔPs							0.5" w.g. (125Pa) ΔPs							1.0" w.g. (249Pa) ΔPs							1.5" w.g. (375Pa) ΔPs							2.0" w.g. (500Pa) ΔPs						
								2	3	4	5	6	7	2	3	4	5	6	7	2	3	4	5	6	7	2	3	4	5	6	7	2	3	4	5	6	7					
1	6	550	260	0.22	54	68	65	60	54	49	45	67	65	59	54	49	46	68	64	59	53	53	52	69	65	60	56	56	57	69	66	62	58	58	61	70	66	62	59	59	63	
		400	189	0.12	30	64	60	55	48	44	40	64	60	55	48	43	39	65	60	55	50	50	49	66	61	56	52	54	54	67	62	57	54	57	58	67	62	57	55	58	60	
		300	142	0.07	17	61	56	51	44	40	36	61	55	51	44	40	36	61	56	52	47	48	47	62	58	53	49	52	51	63	59	54	51	55	54	63	60	54	52	56	55	
		200	94	0.04	9	51	47	43	35	31	25	51	47	43	34	30	25	54	49	45	41	43	40	55	51	48	44	47	44	56	53	50	47	50	47	56	54	51	48	51	48	
		100	47	0.01	3	-	-	-	-	-	-	-	-	-	-	-	-	-	-	-	34	34	31	-	-	-	38	37	35	-	-	45	42	39	38	-	-	47	44	40	39	
	8	550	260	0.06	15	68	65	60	54	49	45	67	65	59	53	49	46	68	64	59	52	52	51	69	65	60	55	55	56	69	66	62	57	57	60	70	66	62	58	58	62	
		400	189	0.03	8	64	60	55	48	44	40	64	60	54	48	43	38	65	60	54	50	50	48	66	61	55	51	53	52	67	62	56	53	56	57	67	62	57	54	58	59	
		300	142	0.02	5	61	56	51	44	40	36	61	55	50	43	39	35	61	56	51	46	47	46	62	58	52	48	50	49	63	59	53	50	54	52	63	60	54	51	55	54	
		200	94	0.01	2	51	47	43	35	31	25	51	46	43	33	29	24	54	49	45	40	42	39	55	51	47	43	45	42	55	53	49	46	49	46	56	54	50	47	50	47	
		100	47	0.01	1	-	-	-	-	-	-	-	-	-	-	-	-	-	-	-	33	33	30	-	-	-	37	35	33	-	-	44	41	38	37	-	-	46	42	39	38	
2	6	550	260	0.20	50	60	55	50	45	39	34	59	54	49	43	38	33	60	54	51	47	49	51	62	58	54	51	54	56	64	61	57	55	58	61	65	62	58	57	60	63	
		400	189	0.11	27	55	49	45	39	32	26	53	48	44	37	31	25	57	51	47	44	48	48	59	55	50	48	53	53	62	59	54	53	58	58	63	60	55	54	60	60	
		200	94	0.04	10	52	46	41	34	25	18	51	46	41	34	25	-	54	49	44	43	44	42	56	51	48	46	48	46	57	53	51	49	52	50	58	54	53	51	53	52	
		850	401	0.11	28	68	64	58	54	49	45	67	62	57	52	48	44	68	63	57	53	53	53	68	64	59	56	55	57	69	65	60	58	58	61	69	65	61	59	58	63	
		700	330	0.08	19	62	58	53	51	44	40	65	60	54	49	44	39	66	60	54	50	51	51	67	62	56	53	54	56	68	63	58	56	57	61	69	64	59	57	58	62	
	8	550	260	0.05	12	60	55	50	45	39	34	59	54	49	42	37	32	60	54	50	46	48	49	62	58	53	50	53	54	64	61	56	54	57	60	65	62	57	56	59	62	
		400	189	0.02	6	55	49	45	39	32	26	53	48	43	36	30	24	56	50	46	43	46	46	59	54	50	47	51	51	61	58	53	52	56	57	62	60	55	53	58	59	
		200	94	0.01	2	52	46	41	34	25	18	51	45	41	33	25	-	54	48	43	41	43	40	55	51	47	45	47	44	57	53	50	48	50	48	57	54	52	49	52	50	
		1100	519	0.12	30	65	62	59	56	52	48	64	60	59	56	52	48	65	62	59	57	55	55	66	63	61	60	58	59	68	65	63	63	61	63	68	65	63	63	61	63	
		900	425	0.08	20	62	58	55	52	48	43	60	57	56	53	48	44	62	59	57	55	53	53	64	61	59	58	57	58	65	64	61	61	60	63	65	64	61	61	60	63	
3	6	1100	519	0.05	12	59	55	52	48	43	38	58	54	53	48	43	38	60	56	54	52	51	51	62	60	56	55	56	56	64	63	58	58	61	62	64	63	58	58	61	62	
		900	425	0.02	5	55	50	47	42	36	28	56	50	48	42	36	28	57	52	49	47	49	47	58	55	51	50	53	52	60	57	54	54	57	56	60	57	54	54	57	56	
		700	330	0.01	2	52	46	41	34	25	18	51	45	41	33	25	-	54	48	43	41	43	40	55	51	47	45	47	44	57	53	50	48	50	48	57	54	52	49	52	50	
		400	189	0.02	5	55	50	47	42	36	28	56	50	48	42	36	28	57	52	49	47	49	47	58	55	51	50	53	52	60	57	54	54	57	56	60	57	54	54	57	56	
		1215	573	0.03	7	67	63	60	58	54	50	66	62	59	57	53	49	67	63	60	58	56	55	68	65	62	61	59	59	69	66	63	63	61	62	69	66	63	63	61	62	
	8	1100	519	0.03	7	65	62	59	56	52	48	64	60	58	56	51	47	65	62	59	57	55	54	66	63	61	59	58	58	68	65	62	62	61	62	68	65	62	62	61	62	
		900	425	0.02	4	62	58	55	52	48	43	60	57	55	52	47	42	62	59	56	54	52	51	64	61	58	57	56	56	65	64	60	59	59	61	65	64	61	61	60	63	
		700	330	0.01	2	59	55	52	48	43	38	57	54	52	47	42	37	59	56	53	51	50	49	61	59	56	54	54	55	64	62	58	57	59	60	64	62	58	57	59	60	
		400	189	0.01	1	55	50	47	42	36	28	56	50	47	41	35	27	56	51	48	46	47	45	58	54	50	49	51	50	59	57	53	52	55	54	59	57	53	52	55	54	
		1550	731	0.10	25	68	64	58	57	55	53	68	64	58	57	54	53	70	66	61	59	58	56	72	68	64	63	60	60	73	70	66	66	63	63	74	70	67	67	64	65	
4	6	1400	661	0.08	19	67	62	57	56	53	51	66	62	57	55	52	51	69	64	59	57	56	54	70	66	62	61	59	58	72	68	65	65	62	63	73	69	66	67	64	64	
		1200	566	0.05	13	65	60	55	53	50	48	63	59	55	52	49	48	67	61	57	55	53	53	68	64	61	59	57	57	70	66	64	64	61	62	71	67	65	66	63	64	
		900	425	0.03	7	61	56	51	49	45	42	60	56	51	48	44	42	63	58	55	53	51	50	64	60	57	57	55	55	65	62	60	61	60	61	65	63	61	62	61	63	
		700	330	0.02	4	59	53	48	45	41	36	57	52	48	44	39	34	61	55	52	51	49	47	62	57	55	54	54	52	63	59	58	58	58	58	63	60	59	59	60	60	
		1550	731	0.05	12	68	64	58	57	55	53	68	64	58	57	54	52	70	66	61	59	57	56	72	68	64	62	59	59	73	70	66	65	62	63	74	70	67	67	63	64	
	8	1400	661	0.03	8	67	62	57	56	53	51	66	62	57	55	52	50	69	64	59	57	55	54	70	66	62	61	58	58	72	68	65	65	62	62	73	69	66	66	63	64	
		1200	566	0.02	5	65	60	55	53	50	48	63	59	55	52	49	47	67	61	57	54	53	52	68	64	60	59	57	56	70	66	63	63	61	61	71	67	64	65	62	63	
		900	425	0.01	3	61	56	51	49	45	42	60	56	51	47	43	40	63	58	54	52	50	48	64	60	57	56	54	53	65	62	59	60	59	59	65	63	61	61	60	61	
		700	330	0.01	2	59	53	48	45	4																																

Performance Data • AHRI Certification and Performance Notes

Model Series 35S • Series Flow • Basic Unit • AHRI Certification Rating Points
Fiberglass Liner

Unit Size	Inlet Size	Fan Airflow		Fan ^Σ Watts	Fan Only* @ .25" w.g. (62 Pa) ΔPs														Primary Airflow		Min. Inlet ΔPs		Fan + 100% Primary @ 1.5" w.g. (375 Pa) ΔPs w/ .25" w.g. (62 Pa) Discharge ΔPs						
					Discharge							Radiated											Radiated						
					2	3	4	5	6	7	2	3	4	5	6	7	cfm	l/s					"w.g.	Pa	2	3	4	5	6
1	6	400	189	105	74	70	66	64	60	57	64	60	55	48	44	40	400	189	0.12	30	67	62	57	54	57	58			
2	8	700	330	155	70	68	64	63	60	57	62	58	53	51	44	40	700	330	0.08	19	68	63	58	56	57	61			
3	10	1100	519	270	73	72	71	69	65	63	65	62	59	56	52	48	1100	519	0.03	7	68	65	62	62	61	62			
4	12	1550	731	430	80	79	74	74	70	69	68	64	58	57	55	53	1550	731	0.05	12	73	70	66	65	62	63			
5	14	2050	967	800	82	79	74	75	72	71	74	69	62	60	57	54	2050	967	0.04	10	73	70	65	62	62	63			
6	14	2100	991	790	77	77	75	77	74	73	72	69	62	60	59	57	2100	991	0.06	15	77	72	65	63	63	64			
7	16	2800	1321	760	76	72	70	69	66	64	70	67	61	55	50	49	2800	1321	0.08	19	71	69	66	61	58	59			

^Σ Motor = ECM.

* Primary air valve is closed and therefore primary cfm is zero.



Ratings are certified in accordance with AHRI Standards.

Performance Notes for Sound Power Levels:

- Discharge (external) static pressure is 0.25" w.g. (63 Pa) in all cases, which is the difference (ΔPs) in static pressure from terminal discharge to the room. Discharge Sound Power Levels (SWL) now include duct end reflection energy as part of the standard rating. Including the duct end correction provides sound power levels that would normally be transmitted into an acoustically, non-reflective duct. The effect of including the energy correction to the discharge SWL, is higher sound power levels when compared to previous AHRI certified data. For more information on duct end reflection calculations see AHRI Standard 880.
- Radiated sound power is the breakout noise transmitted through the unit casing walls.

- Sound power levels are in decibels, dB re 10⁻¹² watts.
- All sound data listed by octave bands is raw data without any corrections for room absorption or duct attenuation. Dash (-) in space indicates sound power level is less than 20 dB or equal to background.
- Min. inlet ΔPs is the minimum operating pressure of the primary air valve section.
- Asterisk (*) in space indicates that the minimum inlet static pressure requirement is greater than 0.5" w.g. (125 Pa) at rated airflow.
- Data derived from independent tests conducted in accordance with ANSI / ASHRAE Standard 130 and AHRI Standard 880.

**SERIES FLOW
CONSTANT OR
VARIABLE VOLUME**

35SST STEALTH™ SERIES

- SUPER QUIET OPERATION

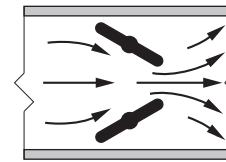

Opposed blade damper configuration minimizes noisy turbulence and provides smooth, accurate, near linear flow control.

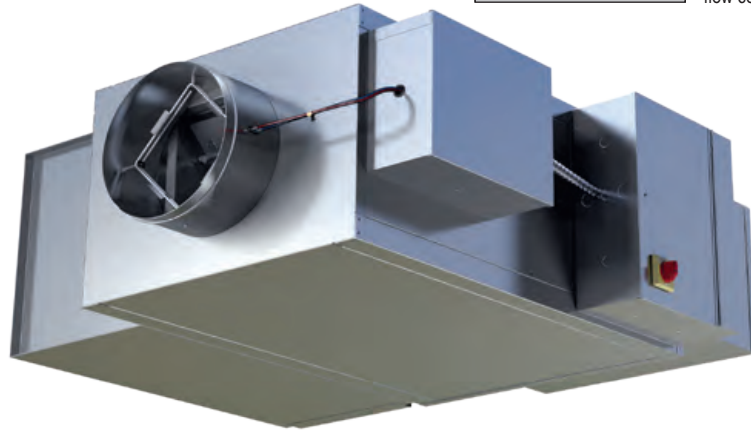

Model 35SEST

Models:

- 35SST** **No Heat**
- 35SEST** **Electric Heat**
- 35SWST** **Hot Water Heat**

The **35SST Stealth™ Series** has been especially designed for the most demanding applications where premium quality design and performance characteristics are desired. Utilizing Stealth™ design technology, this terminal unit has low sound levels that lead the industry.

STANDARD FEATURES:

- Unique 18 ga. (1.31) galvanized steel channel space frame construction provides extreme rigidity and 20 ga. (1.0) casing components.
- 16 ga. (1.61) galvanized steel inclined opposed blade primary air damper. 45° rotation, CW to close. 1/2" (13) dia. plated steel drive shaft. An indicator mark on the end of the shaft shows damper position. Leakage is less than 2% of nominal flow at 3" w.g. (750 Pa).
- Stealth™ design technology provides significant reductions in radiated sound levels.
- Perforated baffle on primary air discharge optimizes mixing with induced air for rapid and effective temperature equalization. The baffle also converts low frequency primary air valve generated sound into more readily attenuated higher frequencies.
- Pressure independent primary airflow control.
- Multi-point averaging Diamond Flow sensor.
- Terminal may be field installed either way up, providing the additional flexibility of right or left field connections.
- Universal access panels on all four sides of terminal for ease of maintenance and service.
- Energy efficient PSC fan motor with thermal overload protection.

- Motor blower assembly mounted on special 16 ga. (1.61) angles and isolated from casing with rubber isolators.
- Adjustable PSC solid state fan speed controller with minimum voltage stop.
- Hinged door on fan controls enclosure.
- 3/4" (19), dual density insulation. exposed edges coated to prevent air erosion. Meets requirements of NFPA 90A and UL 181.
- Available with electric or hot water supplementary heat.
- All controls are mounted on exterior of terminal providing ready access for field adjustment.
- Each terminal factory tested prior to shipment.
- Single point electrical and/or pneumatic main air connection.
- Discharge opening designed for flanged duct connection.
- Full primary air valve low voltage NEMA 1 type enclosure for factory mounted DDC and analog electronic controls.

Controls:

- Nailor EZvav.
- Pneumatic and analog electronic controls. Factory supplied, mounted and calibrated.
- Digital controls. Factory mounting and wiring of DDC controls supplied by BMS Controls Contractor.

Options:

- ECM/EPIC Fan Technology®.
- Primary air valve enclosure for field mounted controls.
- Induced air filter, 1" (25) thick, disposable type.
- Toggle disconnect switch (except units with electric heat, when disconnect is an electric heat option and includes fan).
- Various IAQ linings are available.
- Fan airflow or P.E. switch for night shutdown (pneumatic controls).
- Fan airflow switch for night shutdown (analog electronic controls).
- Night setback fan/heat cycle (pneumatic and analog).
- Fan unit fusing.
- Hanger brackets.
- FN2 90° Line Voltage enclosure.
- FN3 Remote Line Voltage control enclosure.
- Low temperature construction (ice storage systems).



Intertek



FAN POWERED TERMINAL UNITS

C

Standard and Optional Features of the 35SST

- **Electric Heat Option** High efficiency arrowhead insulators eliminate glow and extend element life. Manufactured in-house by Nailor. Removable element rack.

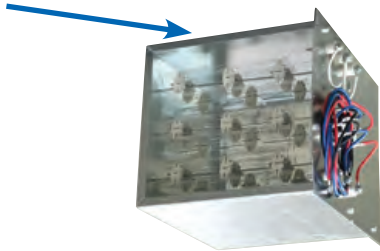

- **Hot Water Coils Option** Hydronic/Electric
Hot Water Coils are fully encased and insulated. Nailor manufactures electric heating elements and can provide them in .1 kw increments.

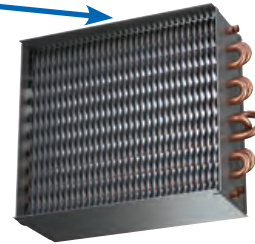

- **Inclined Opposed Blade Primary Air Damper** minimizes noisy turbulence and ensures smooth accurate control

- **Multi-Point Diamond Flow Inlet Sensor**

Durable aluminum multi-point averaging Diamond Flow sensor is more robust than a plastic option and is accurate to +/-5%, even hard 90 elbow at the inlet.

- **Stealth™ Attenuator**

Reduces radiated sound and acts as an access panel for serviceability.

- **18 ga. (1.31) channel space frame construction.** Provides structural strength and secure mounting for the 20 ga insulated panels. These panels provide access on top, bottom and side of the unit. Several liner options for any application.

- **3/4" (19) Dual Density Insulation** meets requirements of NFPA 90A and UL 181. Insulation with a high density skin, on the exposed side and a low density core.

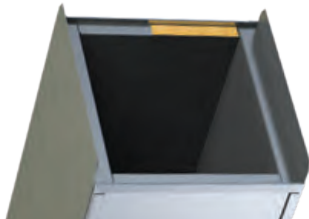

- **24V Controls Enclosure**

- **Line Voltage Enclosure**
With optional FN2 90° enclosure hinged for easy access. Several mounting options, including remote, allow NEC code requirements to be met in tight spaces.



- **Remote Line Voltage Control Enclosure**

Optional FN3 on 48" (1219) umbilical.

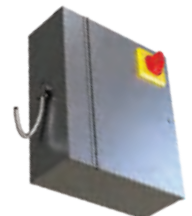

- **Perforated Diffusion Baffle** optimizes mixing of primary and induced airflows and improves sound performance.

- **ECM Motor**
Highly efficient fan and motor combinations are specifically designed to handle advanced control sequences for the most efficient VAV systems.

Dimensions

Model Series 35SST Stealth™ • Series Flow • Unit Sizes 1 – 6

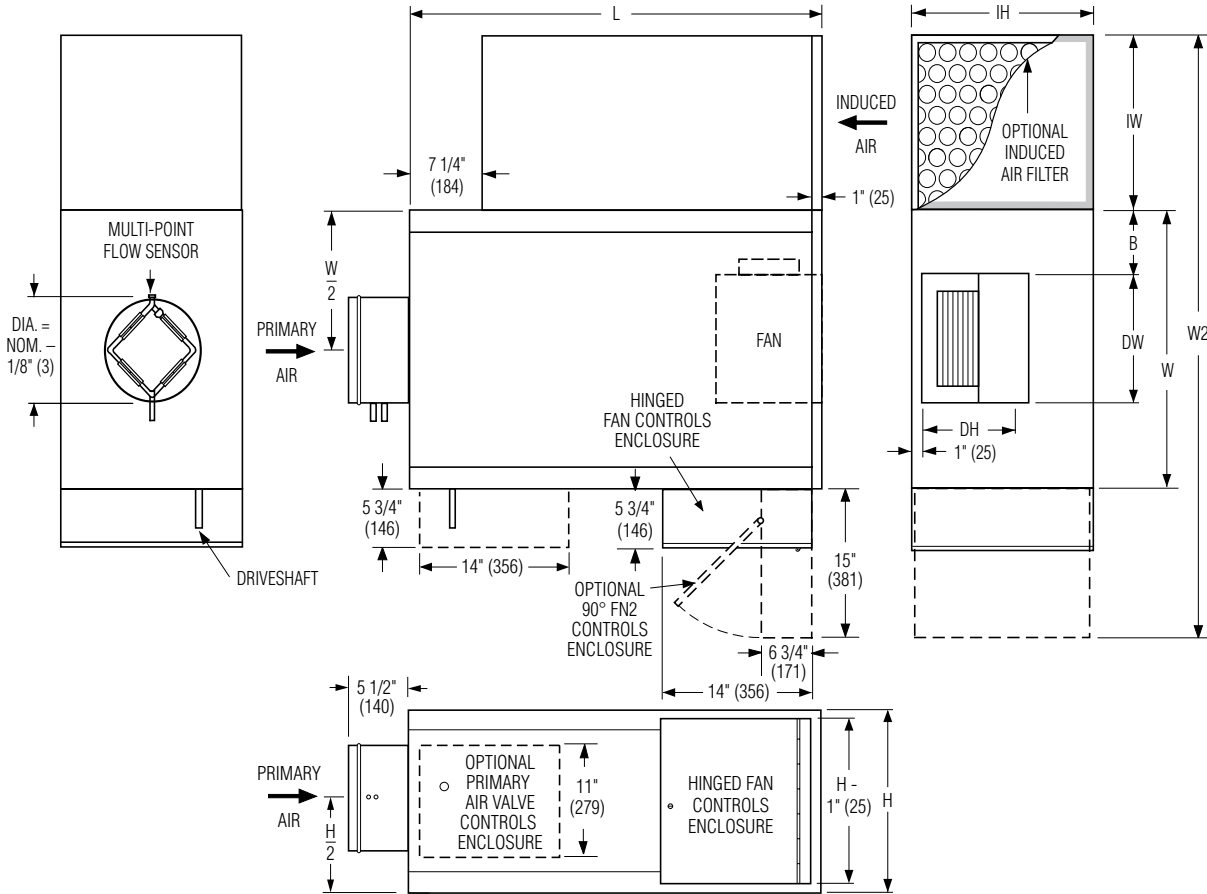

Dimensional Data

Unit Size	Inlet Size	W	W2	H	L	B	Induced Air Inlet IW x IH	Outlet Discharge DW x DH	Filter Size
1	5, 6, 8** (127, 152, 203)	20 (508)	44 (1118)	14 (356)	36 (914)	6 (152)	9 x 14 (229 x 356)	8 1/8 x 4 1/4 (206 x 108)	10 x 14 (254 x 356)
2	6, 8 (152, 203)	18 (457)	42 (1067)	14 (356)	36 (914)	3 1/2 (89)	9 x 14 (229 x 356)	9 1/4 x 10 1/2 (235 x 267)	10 x 14 (254 x 356)
3	6, 8, 10, 12 (152, 203, 254, 305)	18 (457)	44 (1118)	18 (457)	36 (914)	3 1/2 (89)	11 x 18 (279 x 457)	9 1/4 x 10 1/2 (235 x 267)	12 x 18 (305 x 457)
4	8, 10, 12, 14 (203, 254, 305, 356)	26 (660)	56 3/4 (1441)	18 (457)	41 (1041)	6 (152)	15 3/4 x 14 (400 x 356)	12 x 10 1/2 (305 x 267)	16 x 14 (406 x 356)
5	10, 12, 14 (254, 305, 356)	26 (660)	55 1/2 (1410)	18 (457)	41 (1041)	5 (127)	14 1/2 x 18 (368 x 457)	13 1/4 x 11 1/2 (337 x 292)	14 x 18 (356 x 457)
6	12, 14, 16 (305, 356, 406)	30 (762)	65 1/2 (1588)	19 (483)	44 (1118)	6 (152)	17 1/2 x 19 (445 x 483)	13 1/4 x 11 1/2 (337 x 292)	18 x 19 (457 x 483)

** ECM Only.

Dimensions

Model Series 35SST Stealth™ • Series Flow • Unit Size 7

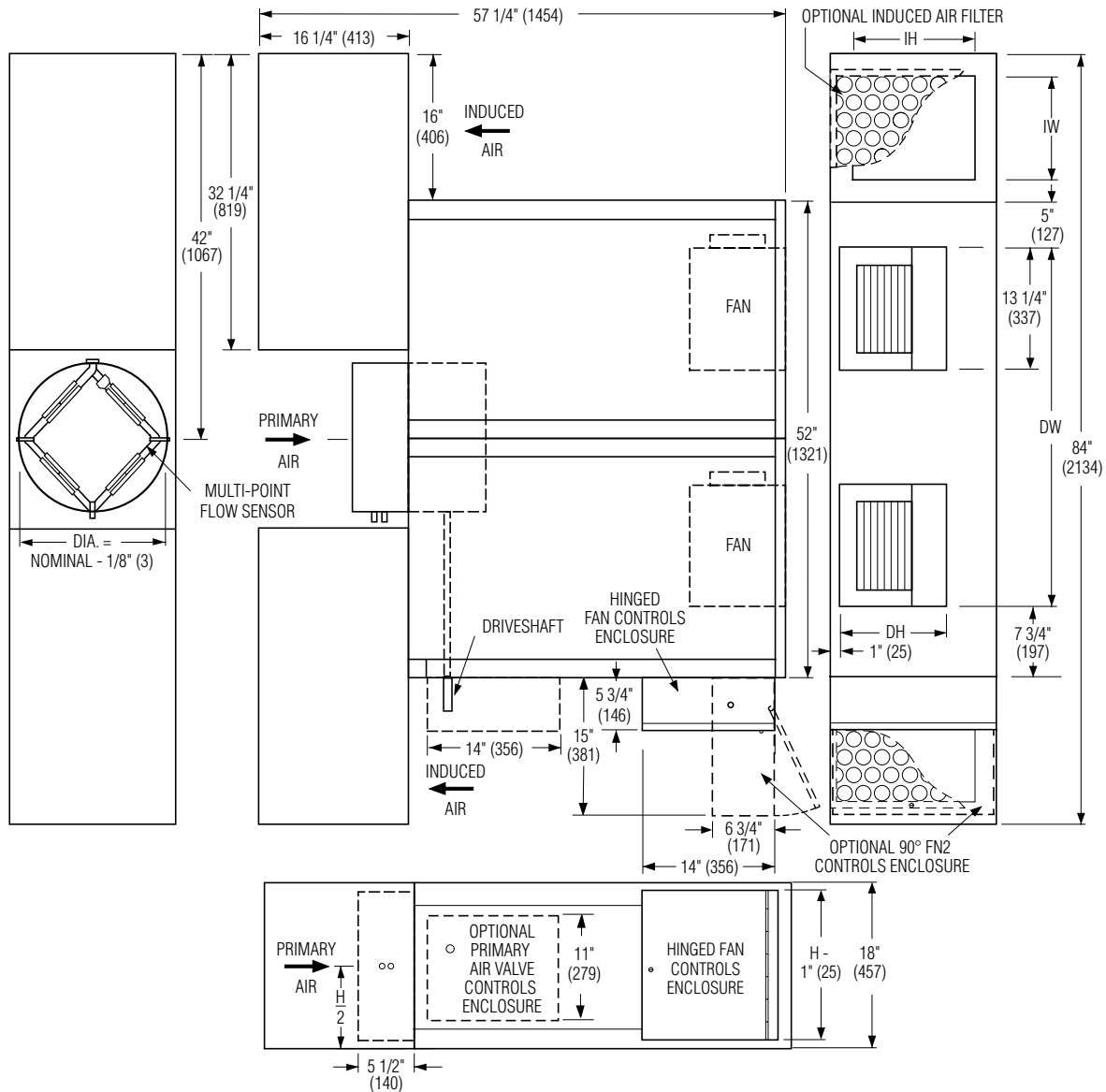

Dimensional Data

Unit Size	Inlet Size	Induced Air Inlet IW x IH	Outlet Discharge DW x DH	Filter Size
7	14, 16 (356, 406)	11 1/4 x 13 1/4 (286 x 337) Qty. of 2	39 1/4 x 11 1/2 (997 x 292)	14 x 14 (356 x 356) Qty. of 2

Dimensions

Model Series 35SST Stealth™ • Series Flow

Hot Water Coil Section

Model 35SWST

Available in one, two or three row. Coil section installed on unit discharge. Right hand coil connection looking in direction of airflow standard (shown). Left hand is optional (terminals are inverted). Connections must be selected same hand as controls enclosure location.

Standard Features:

- Coil section installed on unit discharge.
- Coil (and header on multi-circuit units) is installed in insulated casing for increased thermal efficiency.
- 1/2" (13) copper tubes.
- Aluminum ripple fins.
- Sweat Connections:
 Size 1 – 3: 1 Row 1/2" (13), 2 and 3 Row 7/8" (22); O.D. male solder.
 Size 4 – 6: 1, 2, and 3 Row 7/8" (22); O.D. male solder.
 Size 7: 1 and 2 Row, 7/8" (22), 3 Row 1 3/8" (35); O.D. male solder.
- Top and bottom access panels for inspection and coil cleaning.
- Flanged outlet duct connection.

Unit Sizes 1 – 6

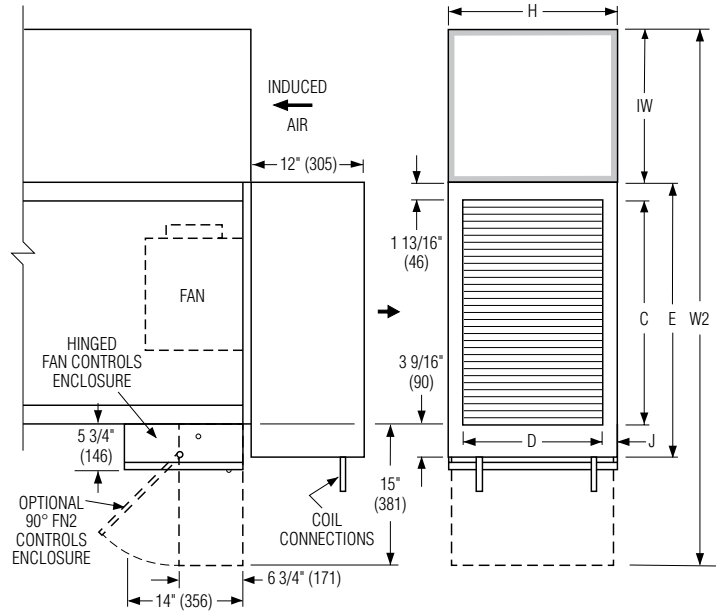

Unit Size 7

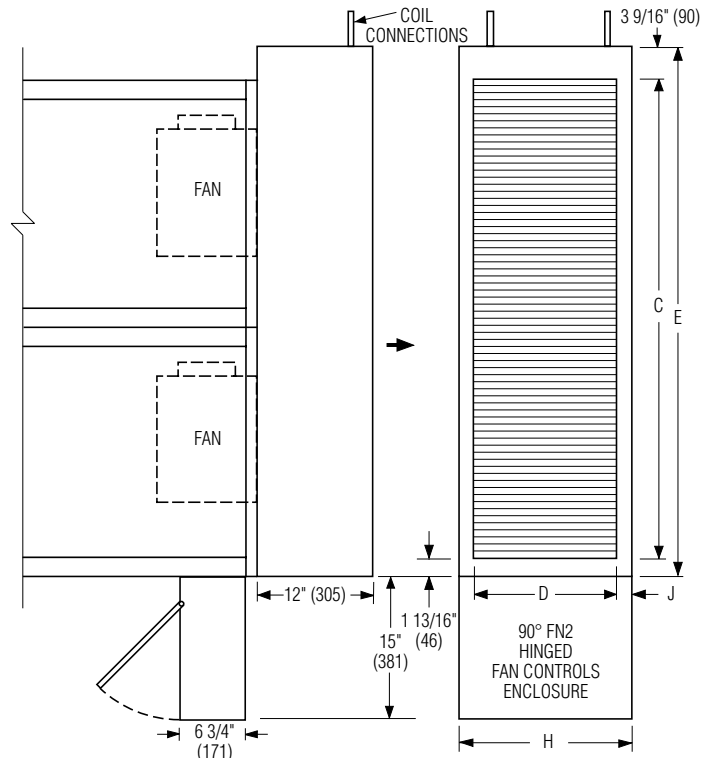

Unit Size	Outlet Duct Size C x D	W2	E	H	J
1	16 x 12 1/8 (406 x 308)	44 (1118)	21 3/8 (543)	14 (356)	1 (25)
2	16 x 12 1/8 (406 x 308)	42 (1067)	21 3/8 (543)	14 (356)	1 (25)
3	16 x 14 7/8 (406 x 378)	44 (1118)	21 3/8 (543)	18 (457)	1 1/2 (38)
4, 5	24 x 14 7/8 (610 x 378)	56 3/4 (1441)	29 3/8 (746)	18 (457)	1 1/2 (38)
6	28 x 17 1/8 (711 x 435)	62 1/2 (1588)	33 3/8 (848)	19 (483)	1 (25)
7	50 x 14 7/8 (1270 x 378)	—	55 3/8 (1407)	18 (457)	1 9/16 (40)

FAN POWERED TERMINAL UNITS

Dimensions

Model Series 35SST Stealth™ • Series Flow

Electric Coil Section

Model 35SEST

Standard Features:

- Unique hinged heater design permits easy access, removal and replacement of heater element without disturbing ductwork.
- Coil installed on unit discharge.
- Insulated coil element wrapper.
- Automatic reset high limit cut-outs (one per element).
- Single point electrical connection for entire terminal unit.
- Magnetic contactors per stage.
- Class A 80/20 Ni/Cr wire.
- Positive pressure airflow switch.
- Flanged outlet duct connection.
- Terminal unit with coil is ETL Listed as an assembly.
- Controls mounted as standard on RH side as shown. Terminals ordered with LH controls (optional) are inverted and discharge duct hanging elevation will therefore change.

Standard Supply Voltage (60 Hz):

- Single phase: 120, 208, 240 & 277V.
- Three phase: 208, 480 (4 wire wye) and 600V (dual point connection).

Options:

- Toggle disconnect switch (includes fan).
- Door interlock disconnect switch.
- Mercury contactors.
- Power circuit fusing.
- Dust tight construction.
- Manual reset secondary thermal cut out.
- SCR Control.

Unit Sizes 1 – 6

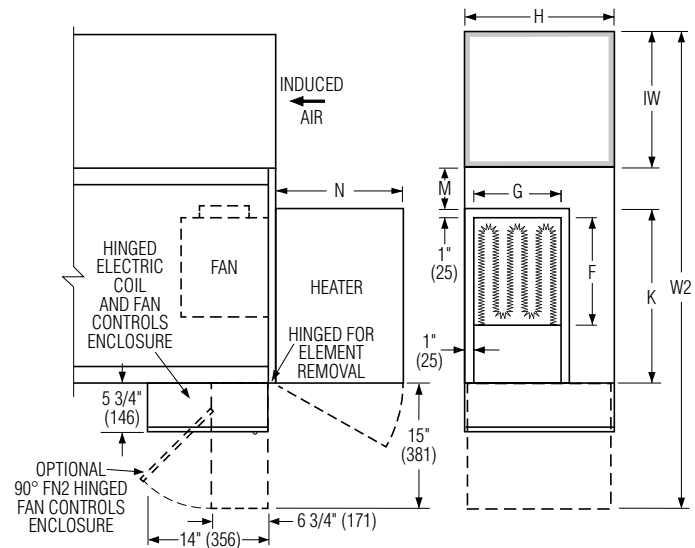

Unit Size 7

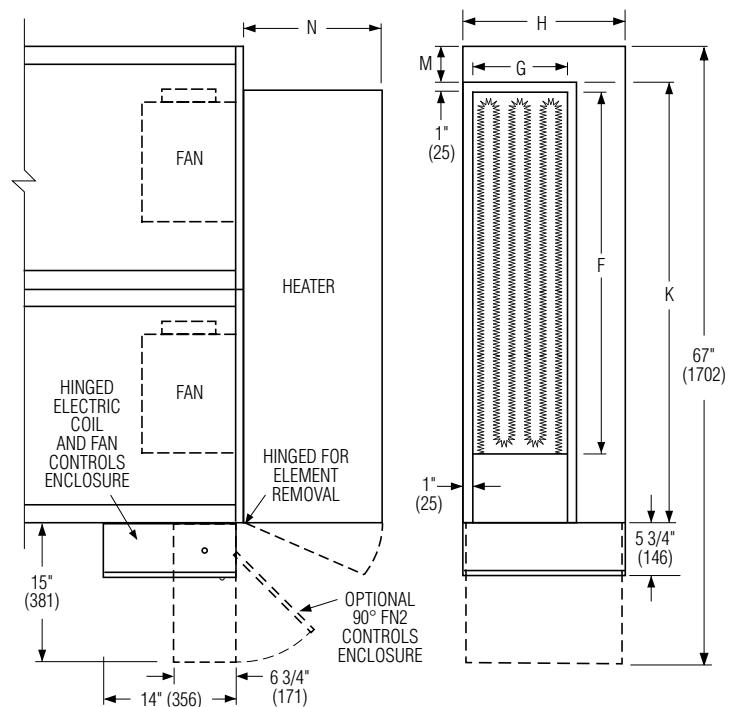

Unit Size	Outlet Duct Size F x G	W2	K	H	M	N
1	10 1/4 x 10 1/2 (260 x 267)	44 (1118)	16 (406)	14 (356)	4 (102)	12 1/2 (318)
2	10 1/4 x 10 1/2 (260 x 267)	42 (1067)	15 1/2 (394)	14 (356)	2 1/2 (64)	12 1/2 (318)
3	10 1/4 x 10 1/2 (260 x 267)	44 (1118)	15 1/2 (394)	18 (457)	2 1/2 (64)	15 1/4 (387)
4	13 x 10 1/2 (330 x 267)	56 3/4 (1441)	21 (533)	18 (457)	5 (127)	15 1/4 (387)
5	14 1/4 x 11 3/4 (362 x 298)	55 1/2 (1410)	22 (559)	18 (457)	4 (102)	15 1/4 (387)
6	14 1/4 x 11 3/4 (362 x 298)	62 1/2 (1558)	25 (635)	19 (483)	5 (127)	15 1/4 (387)
7	40 1/4 x 11 3/4 (1022 x 298)	—	48 (1219)	18 (457)	4 (102)	15 1/4 (387)

Performance Data

PSC Motor Fan Curves – Airflow vs. Downstream Static Pressure

35SST Stealth™ Series • Series Flow

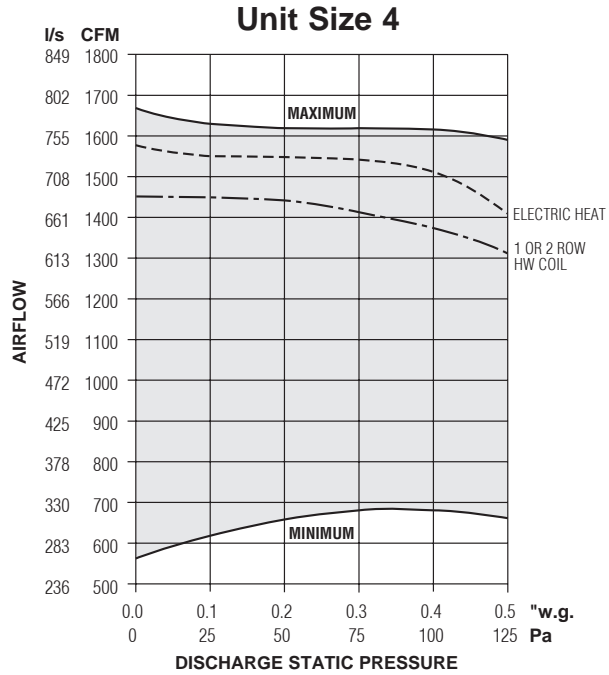
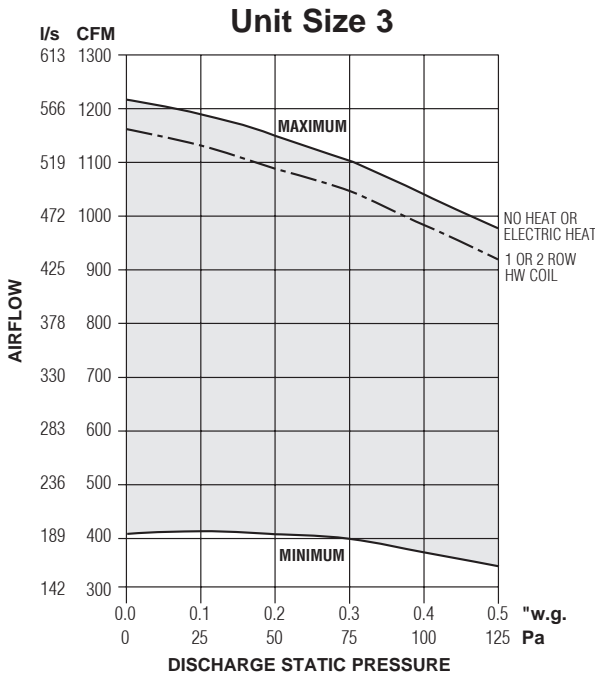
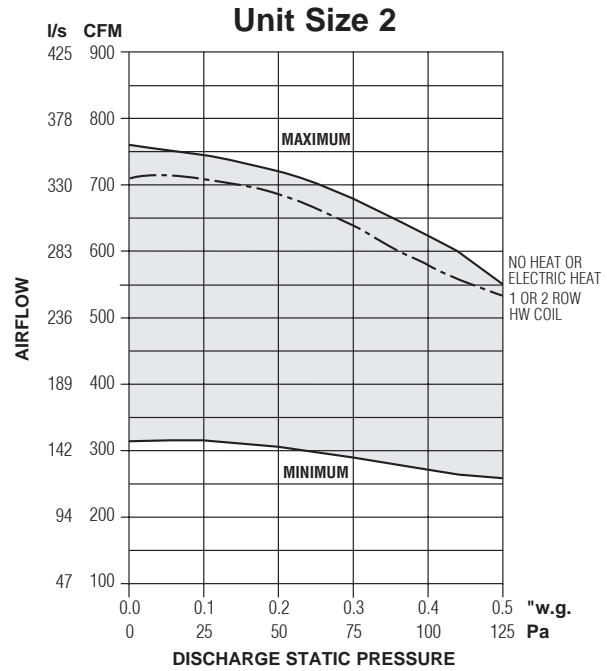
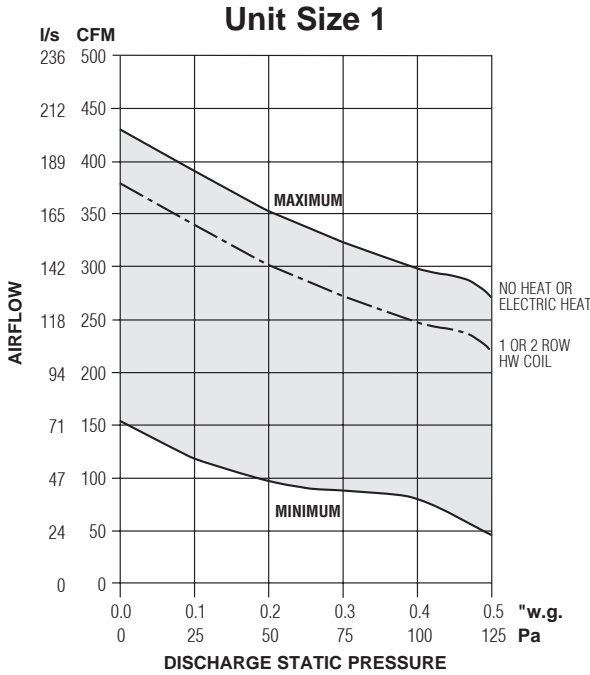

- Fan Curves shown are applicable to 120, 208, 240 and 277 volt, single phase PSC motors.

Electrical Data

Unit Size	PSC Motor FLA	PSC Motor FLA			
		Motor HP	120V	208V	240V
1	1/10	3.0	2.0	2.0	0.9
2	1/10	3.3	2.0	2.0	1.0
3	1/4	5.8	3.6	3.6	1.8
4	1/3	6.2	4.1	4.1	2.0

FLA = Full load amperage.
All motors are single phase/60 Hz.

Performance Data

PSC Motor Fan Curves – Airflow vs. Downstream Static Pressure

35SST Stealth™ Series • Series Flow

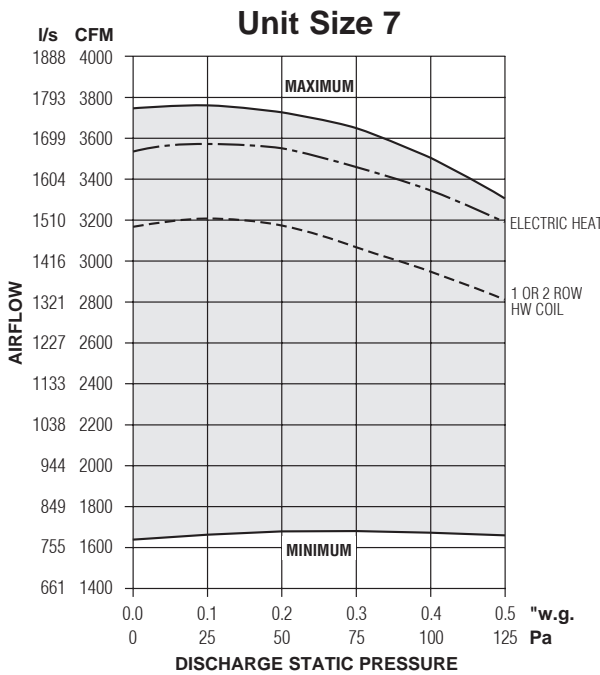
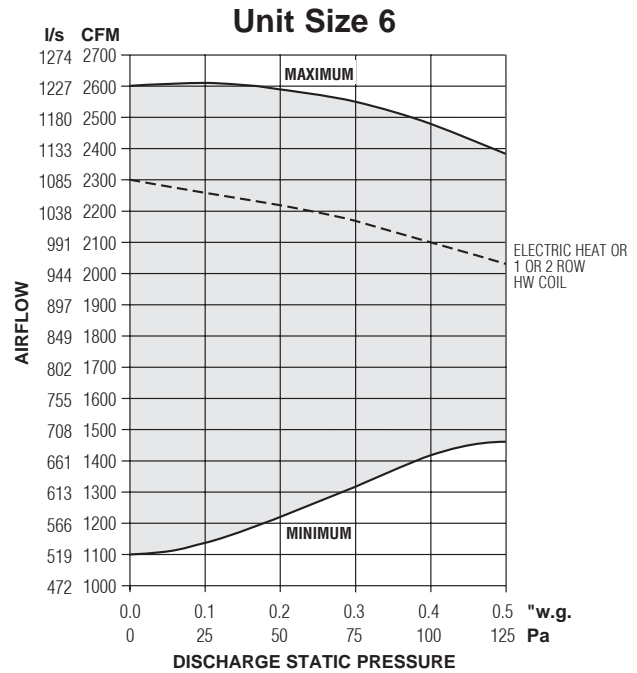
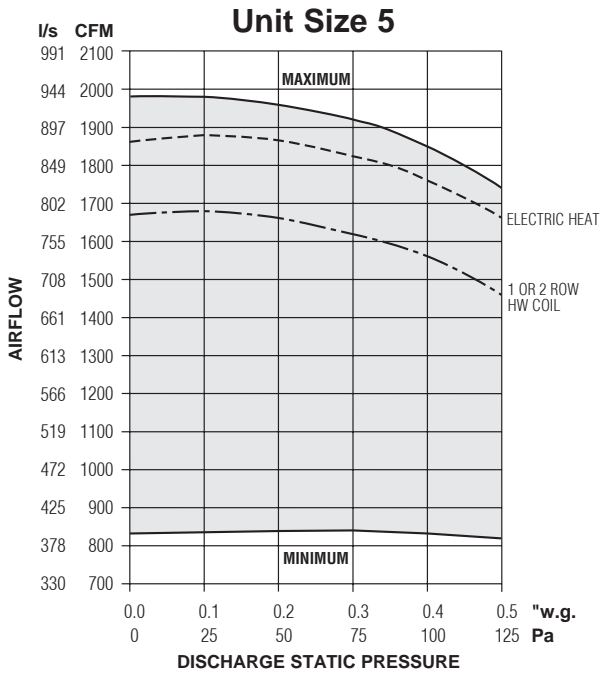

- Fan Curves shown are applicable to 120, 208, 240 and 277 volt, single phase PSC motors.

Electrical Data

Unit Size	PSC Motor FLA	PSC Motor FLA			
		Motor HP	120V	208V	240V
5	1/2	10.1	6.5	6.5	3.3
6	3/4	13.4	8.4	8.4	4.5
7	2@1/2	20.2	13.0	13.0	6.6

FLA = Full load amperage.
All motors are single phase/60 Hz.

Performance Data

ECM Motor Fan Curves – Airflow vs. Downstream Static Pressure

35SST Stealth™ Series • Series Flow

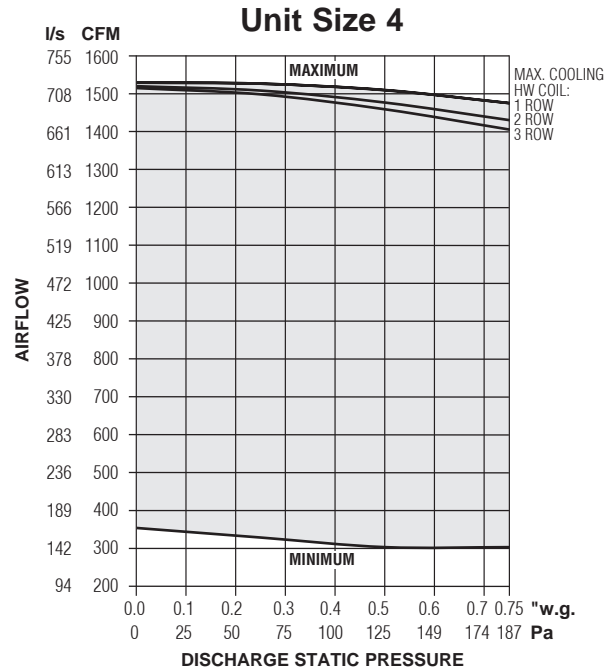
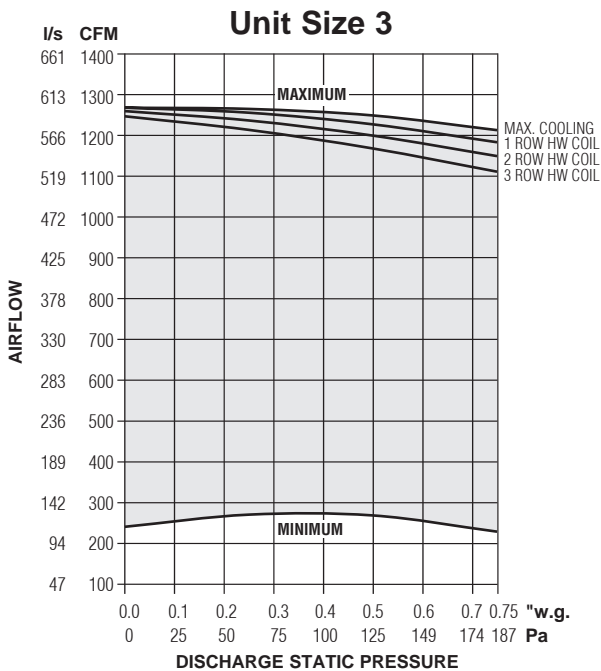
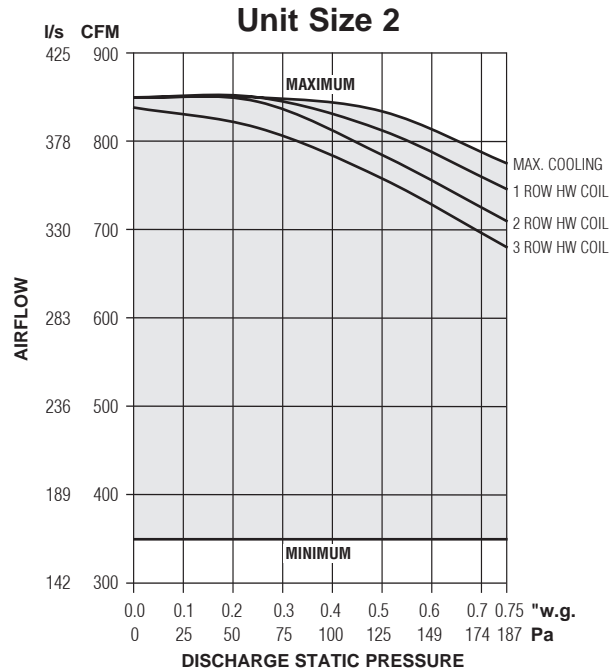
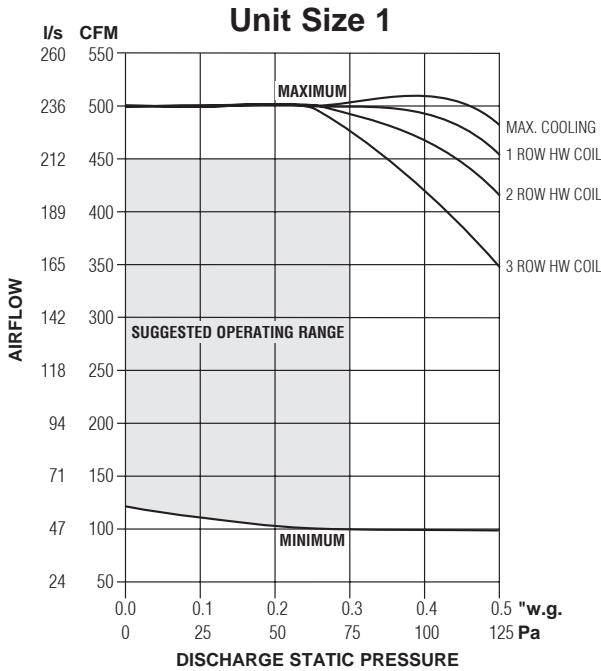

Electrical Data

Unit Size	EPIC ECM Motor FLA				
	Motor HP	120V	208V	240V	277V
1	*	2.1	1.4	1.30	1.2
2	*	4.0	2.7	2.6	2.6
3	*	5.0	3.4	3.3	3.3
4	*	6.9	4.6	4.5	4.2

* The EPIC ECM is a variable horsepower motor. Refer to Selectworks schedule for actual power consumption.
FLA = Full load amperage.
All motors are single phase/60 Hz.

NOTES:

- The ECM is pressure independent and constant volume in operation at factory or field set point within the shaded area. Airflow does not vary with changing static pressure conditions. The motor compensates for any changes in external static pressure or induced air conditions such as filter loading.
- Airflow can be set to operate on horizontal performance line at any point within shaded area using the solid state volume controller provided.
- Fan curves shown are applicable to 120, 208, 240 and 277 volt, single phase ECM's. ECM's, although DC in operation, include a built-in AC/DC converter.



Performance Data

ECM Motor Fan Curves – Airflow vs. Downstream Static Pressure

35SST Stealth™ Series • Series Flow

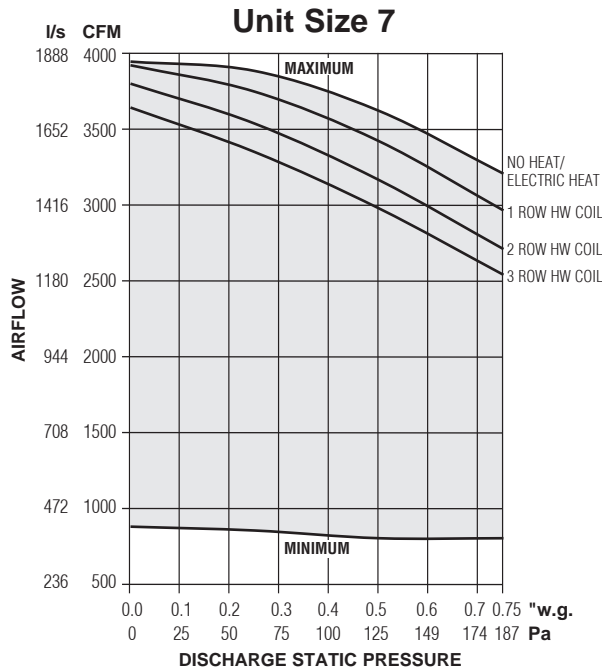
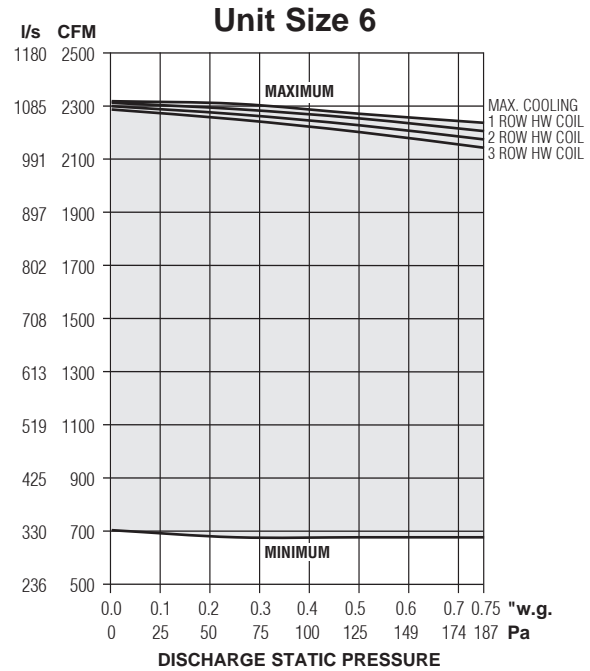
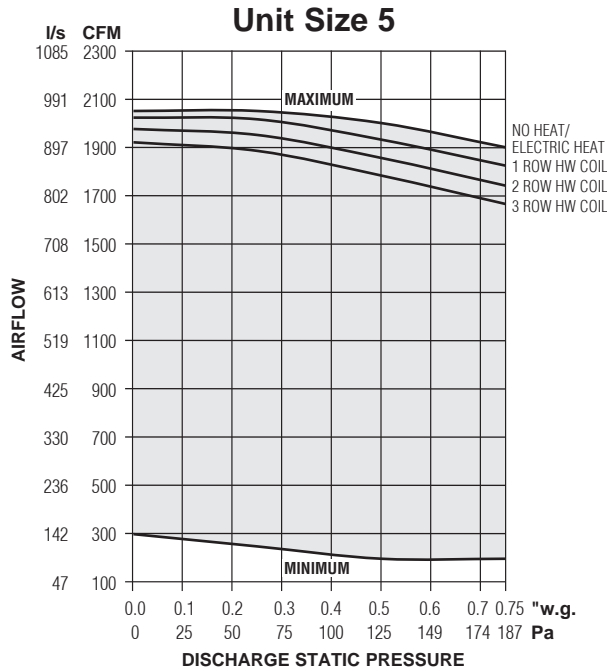

Electrical Data

Unit Size	EPIC ECM Motor FLA				
	Motor HP	120V	208V	240V	277V
5	*	9.0	6.1	5.8	5.6
6	*	11.9	7.3	7.3	7.2
7	*	15.9	10.5	9.9	10.0

* The EPIC ECM is a variable horsepower motor. Refer to Selectworks schedule for actual power consumption.

FLA = Full load amperage. All motors are single phase/60 Hz.

NOTES:

- The ECM is pressure independent and constant variable volume in operation at factory or field set point within the shaded area. Airflow does not vary with changing static pressure conditions. The motor compensates for any changes in external static pressure or induced air conditions such as filter loading.
- Airflow can be set to operate on horizontal performance line at any point within shaded area using the solid state volume controller provided.
- Fan curves shown are applicable to 120, 208, 240 and 277 volt, single phase ECM's. ECM's, although DC in operation, include a built-in AC/DC converter.

Performance Data • NC Level Application Guide

Model Series 35SST Stealth™ • Series Flow

Fiberglass Liner

Unit Size	Inlet Size	Airflow		Min. inlet ΔPs		NC Levels @ Inlet Pressure (ΔPs) shown												
						DISCHARGE					RADIATED							
						Fan Only	Min. ΔPs	0.5 w.g. (125 Pa)	1.0" w.g. (250 Pa)	1.5" w.g. (375 Pa)	2.0" w.g. (500 Pa)	Fan Only	Min. ΔPs	0.5" w.g. (125 Pa)	1.0" w.g. (250 Pa)	1.5" w.g. (375 Pa)	2.0" w.g. (500 Pa)	
1	6	550	260	0.22	54	36	36	34	35	36	36	36	35	35	36	38	38	
		400	189	0.12	30	28	26	26	28	29	29	29	29	30	31	33	34	
		300	142	0.07	17	-	-	20	20	21	23	24	25	25	28	29	30	
		200	94	0.04	9	-	-	-	-	-	-	-	-	-	-	21	23	
		100	47	0.01	3	-	-	-	-	-	-	-	-	-	-	-	-	
	8	550	260	0.06	15	36	35	33	34	35	35	36	35	35	36	38	38	
		400	189	0.03	8	28	25	25	26	28	29	29	29	30	31	33	34	
		300	142	0.02	5	-	-	-	-	20	21	24	25	25	28	29	30	
		200	94	0.01	2	-	-	-	-	-	-	-	-	-	-	21	23	
		100	47	0.01	1	-	-	-	-	-	-	-	-	-	-	-	-	
2	6	550	260	0.20	50	21	24	25	28	30	31	21	23	25	29	33	34	
		400	189	0.11	27	-	-	-	23	25	26	-	-	-	24	30	33	
		200	94	0.04	10	-	-	-	20	-	20	-	-	-	-	23	24	
	8	850	401	0.11	28	31	34	34	34	35	36	30	34	34	35	36	37	
		700	330	0.08	19	26	29	30	33	34	34	26	29	31	33	34	35	
		550	260	0.05	12	21	21	24	25	29	30	21	23	25	29	33	34	
		400	189	0.02	6	-	-	-	20	23	24	-	-	-	24	29	31	
		200	94	0.00	1	-	-	-	-	-	-	-	-	-	-	21	24	
	3	6	550	260	0.20	50	23	25	25	29	30	30	21	20	23	28	33	33
			400	189	0.11	27	-	-	-	20	23	23	-	-	-	23	26	26
8		1100	519	0.12	30	33	31	31	33	34	35	31	29	30	33	35	35	
		900	425	0.08	20	28	26	28	29	31	33	26	24	26	30	34	34	
		700	330	0.05	12	23	24	24	26	29	30	21	20	23	28	33	33	
		400	189	0.02	5	-	-	-	-	20	20	-	-	-	21	26	26	
10		1215	573	0.03	7	35	34	34	35	35	36	33	31	33	34	36	36	
		1100	519	0.03	7	33	31	31	31	34	35	31	29	30	33	35	35	
		900	425	0.02	4	28	25	25	28	30	31	26	24	26	30	34	34	
		700	330	0.01	3	23	21	23	24	26	28	21	20	23	28	33	33	
4	10	1550	731	0.10	25	39	37	40	40	43	44	34	33	35	37	39	40	
		1400	661	0.08	19	35	34	37	39	40	40	31	30	33	35	38	38	
		1200	566	0.05	13	30	30	33	33	39	37	28	26	30	33	36	37	
		900	425	0.03	7	25	25	28	31	30	31	21	21	25	28	31	31	
		700	330	0.02	4	21	23	25	26	26	26	-	-	23	25	28	29	
	12	1550	731	0.05	12	39	36	39	40	41	43	34	33	35	37	39	40	
		1400	661	0.03	8	35	33	36	38	39	40	31	30	33	35	38	38	
		1200	566	0.02	5	30	29	33	37	37	37	28	26	30	33	36	37	
		900	425	0.01	3	25	23	26	30	29	29	21	21	25	28	31	31	
		700	330	0.01	2	21	20	24	25	24	24	-	-	23	24	28	29	
5	12	2050	967	0.06	15	39	39	40	41	43	44	37	36	36	37	39	39	
		1850	873	0.05	12	36	36	37	39	40	40	34	33	34	36	37	38	
		1600	755	0.04	10	33	33	35	37	37	38	30	31	33	34	36	37	
		1350	637	0.03	7	29	28	31	33	34	35	28	28	29	31	34	35	
		1100	519	0.02	5	25	25	28	29	31	30	24	24	26	29	31	33	
	14	2050	967	0.04	10	39	39	39	41	43	43	37	36	36	37	39	39	
		1850	873	0.03	8	36	35	37	38	39	40	34	33	34	36	37	38	
		1600	755	0.03	7	33	31	34	36	37	38	30	31	33	34	36	37	
		1350	637	0.02	5	29	28	30	33	34	35	28	28	29	31	34	35	
		1100	519	0.01	3	25	23	25	28	29	29	24	24	26	29	31	33	
6	14	2400	1133	0.08	20	40	40	40	43	44	45	38	36	37	39	41	41	
		2100	991	0.06	15	37	36	38	39	40	41	36	33	35	37	40	40	
		2000	944	0.05	13	36	35	37	38	39	40	36	31	35	37	39	39	
		1700	802	0.04	10	33	30	34	35	36	37	33	28	30	34	37	37	
		1400	661	0.03	6	26	24	27	29	30	30	28	24	26	30	35	35	
7	14	3370	1590	0.20	50	39	37	38	40	41	43	40	36	38	39	40	41	
		2800	1321	0.15	37	34	31	34	36	37	36	36	33	33	35	38	39	
		2100	991	0.10	25	26	24	28	28	30	30	30	29	29	31	34	36	
		1600	755	0.07	17	21	21	23	24	26	28	28	25	26	29	33	34	
		1100	519	0.05	12	-	-	-	20	23	25	25	24	24	26	29	31	
	16	4000	1888	0.15	38	43	39	40	41	44	45	44	39	40	41	43	44	
		3500	1652	0.12	29	39	36	37	39	40	41	40	36	38	39	40	41	
		2800	1321	0.08	19	34	30	33	35	37	36	36	33	33	35	38	39	
		2100	991	0.04	11	26	24	26	28	29	30	30	29	29	31	34	35	
		1600	755	0.03	6	21	-	21	21	21	24	26	28	25	26	29	32	34

Performance Notes: 1. NC Levels are calculated based on procedures as outlined on page C160

2. Dash (-) in space indicates a NC less than 20.

FAN POWERED TERMINAL UNITS

Performance Data • Discharge Sound Power Levels

Model Series 35SST Stealth™ • Series Flow

Fiberglass Liner



Unit Size	Inlet Size	Airflow		Min. inlet ΔPs		Fan Only		Fan and 100% Primary Air—Sound Power Octave Bands @ Inlet pressure (ΔPs) shown																																		
								Minimum ΔPs							0.5" w.g. (125Pa) ΔPs							1.0" w.g. (249Pa) ΔPs							1.5" w.g. (375Pa) ΔPs							2.0" w.g. (500Pa) ΔPs						
								2	3	4	5	6	7	2	3	4	5	6	7	2	3	4	5	6	7	2	3	4	5	6	7	2	3	4	5	6	7	2	3	4	5	6
1	6	550	260	0.22	54	78	75	69	67	64	61	78	75	68	66	63	60	76	73	67	65	62	59	77	74	67	66	62	59	78	75	68	66	62	60	78	75	68	66	62	60	
		400	189	0.12	30	71	68	64	60	57	54	71	67	63	60	56	53	71	67	62	59	55	52	71	68	63	59	55	52	72	69	63	59	55	52	73	69	64	60	56	53	
		300	142	0.07	17	66	61	59	53	49	45	66	60	57	53	49	45	67	61	57	53	48	44	67	62	58	53	49	45	68	63	59	54	49	45	68	64	60	54	50	46	
		200	94	0.04	9	62	53	52	45	39	32	60	52	49	43	38	31	60	54	51	44	38	32	62	56	53	46	40	34	63	58	54	47	41	36	62	58	55	48	42	38	
		100	47	0.01	3	59	49	43	37	30	22	58	48	41	35	28	21	58	49	43	36	30	22	59	50	45	38	32	26	60	51	49	40	33	28	58	50	47	40	34	30	
	8	550	260	0.06	15	78	75	69	67	64	61	77	74	67	66	63	60	75	72	66	65	62	59	76	73	66	66	62	59	77	74	67	66	62	60	77	74	67	66	62	60	
		400	189	0.03	8	71	68	64	60	57	54	70	66	62	59	56	53	70	66	62	58	55	52	70	67	63	59	55	52	70	68	63	59	55	52	71	68	64	59	56	53	
		300	142	0.02	5	66	61	59	53	49	45	64	59	56	52	49	45	65	60	56	52	48	44	65	61	57	52	49	45	66	62	57	53	49	45	66	63	59	54	50	46	
		200	94	0.01	2	62	53	52	45	39	32	59	51	48	43	38	31	59	52	50	44	38	32	60	54	52	45	40	34	61	56	53	46	41	36	60	57	54	47	42	37	
		100	47	0.01	1	59	49	43	37	30	22	55	46	39	35	28	21	55	47	42	36	29	22	56	49	44	38	31	25	57	50	47	39	33	28	56	49	46	39	34	30	
2	6	550	260	0.20	50	66	63	59	57	54	51	66	65	61	57	53	49	69	66	62	57	53	50	72	68	62	57	53	50	75	70	62	58	54	51	76	71	63	58	54	51	
		400	189	0.11	27	62	59	56	53	49	44	63	61	56	52	48	43	65	61	57	52	48	42	69	64	57	52	48	43	71	66	58	53	48	44	71	67	59	53	49	45	
		200	94	0.04	10	58	52	49	44	38	28	59	53	48	44	36	27	62	54	49	44	37	28	64	57	51	45	38	30	63	58	53	46	38	32	64	58	53	46	39	33	
		850	401	0.11	28	73	72	67	68	64	62	76	74	68	67	64	62	76	74	68	66	63	61	76	74	68	66	63	61	77	75	68	66	63	61	78	76	68	66	63	61	
		700	330	0.08	19	69	67	63	62	59	57	70	69	64	62	59	56	72	70	64	61	59	56	73	70	64	61	58	56	75	72	65	62	59	57	76	73	65	62	59	57	
	8	550	260	0.05	12	66	63	59	57	54	51	65	63	59	56	53	49	67	65	60	57	53	50	70	66	61	57	53	50	73	69	61	58	54	51	73	70	62	58	54	51	
		400	189	0.02	6	62	59	56	53	49	44	62	59	55	52	47	42	63	59	55	51	47	42	67	62	56	52	47	43	69	64	57	52	48	44	69	65	58	53	48	44	
		200	94	0.00	1	58	52	49	44	38	28	57	51	47	43	36	27	59	53	48	43	37	28	61	55	50	44	37	30	61	56	51	45	38	32	61	56	52	45	38	33	
		550	260	0.20	50	65	64	63	59	55	51	68	66	64	59	54	49	69	66	65	59	54	50	74	67	65	59	54	50	75	70	65	59	54	51	75	70	65	60	55	51	
		400	189	0.11	27	63	57	55	51	45	37	66	60	57	51	45	36	66	61	58	52	46	37	67	61	57	51	46	38	68	64	58	51	47	41	68	64	58	52	48	43	
3	8	1100	519	0.12	30	73	73	71	69	66	63	73	72	71	68	64	62	73	72	71	68	64	62	75	73	71	68	64	62	77	74	71	68	64	62	77	75	71	68	64	62	
		900	425	0.08	20	69	69	68	64	61	58	69	68	68	63	59	56	70	69	68	63	60	57	73	70	68	64	60	57	75	72	68	64	60	57	75	73	68	64	60	57	
		700	330	0.05	12	65	64	63	59	55	51	66	65	63	59	54	50	67	65	64	59	55	50	72	67	63	59	55	50	72	69	64	59	55	51	73	70	64	59	55	52	
		400	189	0.02	5	63	57	55	51	45	37	65	58	56	51	45	36	64	59	57	52	46	37	66	60	57	51	45	38	66	62	57	51	47	41	66	62	58	52	47	42	
		1215	573	0.03	7	76	75	73	72	68	66	74	74	72	70	67	64	74	74	72	70	67	65	75	75	72	70	67	65	77	75	73	70	67	65	77	76	73	70	67	65	
	10	1100	519	0.03	7	73	73	71	69	66	63	71	72	70	67	64	62	72	72	70	68	64	62	73	72	70	68	64	62	75	74	70	68	64	62	76	75	71	67	64	62	
		900	425	0.02	4	69	69	68	64	61	58	67	67	66	63	59	56	68	67	66	63	60	57	71	69	66	63	60	57	73	71	67	63	60	57	73	72	67	63	60	57	
		700	330	0.01	3	65	64	63	59	55	51	64	63	62	58	54	49	65	64	62	58	54	50	70	65	62	58	54	50	70	67	63	58	54	50	70	67	63	58	54	51	
		400	189	0.01	1	63	57	55	51	45	37	62	56	55	50	44	35	62	57	56	51	45	37	63	58	55	50	45	37	64	60	56	50	46	40	64	60	56	51	47	42	
		1550	731	0.10	25	80	79	74	75	71	70	78	77	74	73	69	69	82	80	75	74	71	70	83	80	76	74	71	70	85	82	77	75	72	71	86	83	77	76	72	71	
4	10	1400	661	0.08	19	77	75	72	71	67	66	75	74	71	69	66	65	80	77	73	71	67	66	83	79	75	72	69	68	83	80	74	72	69	68	84	80	75	73	69	68	
		1200	566	0.05	13	73	71	69	67	64	62	73	71	69	67	63	61	78	73	70	68	64	63	84	78	73	71	67	66	82	77	72	70	66	65	82	78	72	70	66	65	
		900	425	0.03	7	69	67	64	62	58	54	69	67	64	61	56	53	74	69	66	63	58	56	78	72	68	65	60	57	76	71	66	63	58	55	76	72	67	63	58	55	
		700	330	0.02	4	66	63	61	58	54	49	66	64	61	57	53	48	71	66	62	59	55	51	72	67	63	60	55	52	71	67	62	58	53	49	71	67	62	58	54	49	
		1550	731	0.05	12	80	79	74	75	71	70	77	76	73	73	69	69	82	79	74	74	71	70	82	80	75	74	71	70	84	81	76	75	72	71	85	82	77	76	72	71	
	12	1400	661	0.03	8	77	75	72	71	67	66	74	73	71	69	66	65	79	76	72	71	67	66	82	78	74	72	69	68	82	79	74	72	69	68	83	80	74	72	69	68	
		1200	566	0.02	5	73	71	69	67	64	62	71	70	68	66	63	61	76	73	69	67	64	63	82	77	73	70	67	66	80	77	71	70	66	65	80	77	72	69	66	65	
		900	425	0.01	3	69	67	64	62	58	54	67	65	63	61	56	53	72	68	65	62	58	56	75	71	67	64	60	57	74	70	65	62	58	55	74	70	65	62	58	55	
		700	330	0.01	2	66	63	61	58	54	49	64	62	59	57	52	48	69	64	61	59	54	51	70	66	62	59	55	51	69	65	60	57	53	49	69	65	61	58	53	49	
		2050	967	0.06	15	82	79	75	76	72	71	82	79	75																												

Performance Data • AHRI Certification and Performance Notes

Model Series 35SST Stealth™ • Series Flow • AHRI Certification Rating Points

Fiberglass Liner

Unit Size	Inlet Size	Fan Airflow		Fan ^Σ Watts	Fan Only* @ .25" w.g. (62 Pa) ΔPs														Primary Airflow		Min. Inlet ΔPs		Fan + 100% Primary @ 1.5" w.g. (375 Pa) ΔPs w/ .25" w.g. (62 Pa) Discharge ΔPs						
					Discharge							Radiated											Radiated						
					2	3	4	5	6	7	2	3	4	5	6	7	cfm	l/s					"w.g.	Pa	2	3	4	5	6
1	6	400	189	105	71	68	64	60	57	54	62	59	52	45	41	37	400	189	0.12	30	64	62	54	47	45	44			
2	8	700	330	155	69	67	63	62	59	57	59	57	50	45	41	37	700	330	0.08	19	67	63	55	49	45	45			
3	10	1100	519	270	73	73	71	69	66	63	63	61	53	49	45	42	1100	519	0.03	7	64	64	56	53	49	48			
4	12	1550	731	430	80	79	74	75	71	70	68	63	56	53	53	50	1550	731	0.05	12	72	68	62	58	54	53			
5	14	2050	967	800	82	79	75	76	72	71	71	66	59	56	52	49	2050	967	0.04	10	72	68	62	57	54	52			
6	14	2100	991	790	78	77	75	77	73	72	70	65	59	55	51	47	2100	991	0.06	15	73	69	62	57	54	53			
7	16	2800	1321	760	77	74	71	70	67	66	69	65	56	53	50	46	2800	1321	0.08	19	72	66	61	55	51	49			

^Σ Motor = ECM.

* Primary air valve is closed and therefore primary cfm is zero.



Ratings are certified in accordance with AHRI Standards.

Performance Notes for Sound Power Levels:

1. Discharge (external) static pressure is 0.25" w.g. (63 Pa) in all cases, which is the difference (ΔPs) in static pressure from terminal discharge to the room.
Discharge Sound Power Levels (SWL) now include duct end reflection energy as part of the standard rating. Including the duct end correction provides sound power levels that would normally be transmitted into an acoustically, non-reflective duct. The effect of including the energy correction to the discharge SWL, is higher sound power levels when compared to previous AHRI certified data. For more information on duct end reflection calculations see AHRI Standard 880.
2. Radiated sound power is the breakout noise transmitted through the unit casing walls.
3. Sound power levels are in decibels, dB re 10⁻¹² watts.

4. All sound data listed by octave bands is raw data without any corrections for room absorption or duct attenuation. Dash (-) in space indicates sound power level is less than 20 dB or equal to background.
5. Min. inlet ΔPs is the minimum operating pressure of the primary air valve section.
6. Asterisk (*) in space indicates that the minimum inlet static pressure requirement is greater than 0.5" w.g. (125 Pa) at rated airflow.
7. Data derived from independent tests conducted in accordance with ANSI / ASHRAE Standard 130 and AHRI Standard 880.

FAN POWERED TERMINAL UNITS

**SERIES FLOW
CONSTANT OR
VARIABLE VOLUME
WITH OUTSIDE AIR INLET
35S AND 35SST SERIES**

- MINIMUM VENTILATION IAQ APPLICATIONS



Model 35S-OAI



Models:

- 35S-OAI** No Heat
- 35SE-OAI** Electric Heat
- 35SW-OAI** Hot Water Heat
- 35SST-OAI** No Heat Stealth™
- 35SEST-OAI** Electric Heat Stealth™
- 35SWST-OAI** Hot Water Heat Stealth™

FAN POWERED TERMINAL UNITS

A major concern facing building owners and engineers today is Indoor Air Quality (IAQ). Nailor has developed an IAQ fan powered terminal unit option that addresses this issue. Nailor's 35S-OAI and 35SST-OAI Stealth™ fan powered terminal units with the OAI feature provide a direct connection for outside air to the terminal, in addition to the standard cool air connection. The OAI feature adds a second pressure independent outside air valve.

New standards practice for HVAC system design, including ANSI/ASHRAE Standard 62.1, dictate a minimum amount of ventilation within buildings. Ventilation control has traditionally been done at the central air handling unit; however, this does not always ensure the minimum ventilation to each zone is maintained.

The OAI feature controls outside air to each occupied zone, independently of the primary cooling requirement and therefore prevents over-ventilation that might otherwise occur when relying on sufficient outside air from the primary air system. The OAI feature dual duct inlet design allows the fan powered terminal unit to mix the outside air to the zone with the primary cooling air. The outside air pressure independent air valve provides a constant volume to the zone regardless of thermal conditions. This fixes the outside air requirement for the zone without putting excessive demands for outside air on the primary air handler. In turn, the primary air handler does not have to reset outside air rates for all zones in the building. The first cost of the outside air handler and its associated ductwork can be offset by the savings provided by running smaller outside air volumes for those zones with lower occupancy rates.

The OAI feature is perfect for schools. The high occupancy in the classrooms is served without creating excessive loads at the primary air handler serving zones with lower occupancies. Office buildings with conference rooms, kitchen areas and workrooms with copiers can also benefit. When these areas are occupied and require large percentages of outside air, the primary air handler does not have to reset the outside air for all the office spaces in the building.

When integrated with a DDC building management system, the amount of outside air can be tracked and logged to ensure 'IAQ' standards for each zone are met and by using occupancy sensors, the outside air volume for individual zones can be reset.

STANDARD FEATURES:

- Engineered integral dual duct inlet design is compact and not a bolt on single duct terminal.
- Diamond Flow sensor located in both primary and outside air inlets.
- Universal access panels for ease maintenance and service.
- Energy efficient PSC fan motor with thermal overload protection.
- Available with electric or hot water supplementary heat.
- Dual air value enclosure for factory

mounted DDC controls.

- 3/4" (19), dual density insulation. Exposed edges coated to prevent air erosion. Meets requirements of NFPA 90A and UL 181.
- Adjustable PSC solid state fan speed controller with minimum voltage stop.
- Hinged door on fan controls enclosure.

Controls:

- Digital controls. Factory mounting and wiring of DDC controls supplied by BMS controls contractor.

Options:

- ECM/EPIC Fan Technology®.
- Induced air filter, 1" (25) thick disposable type.
- Various IAQ linings.
- Q option induced air attenuator.
- Top entry induced air inlet.
- Low temperature construction.
- FN2 90° Line Voltage enclosure.
- FN3 Remote Line Voltage controls enclosure.

Performance Data:

Refer to 35S and 35SST data.

Dimensions

Mode 35S-OAI • Series Flow • Outside Air Inlet • Unit Size 7

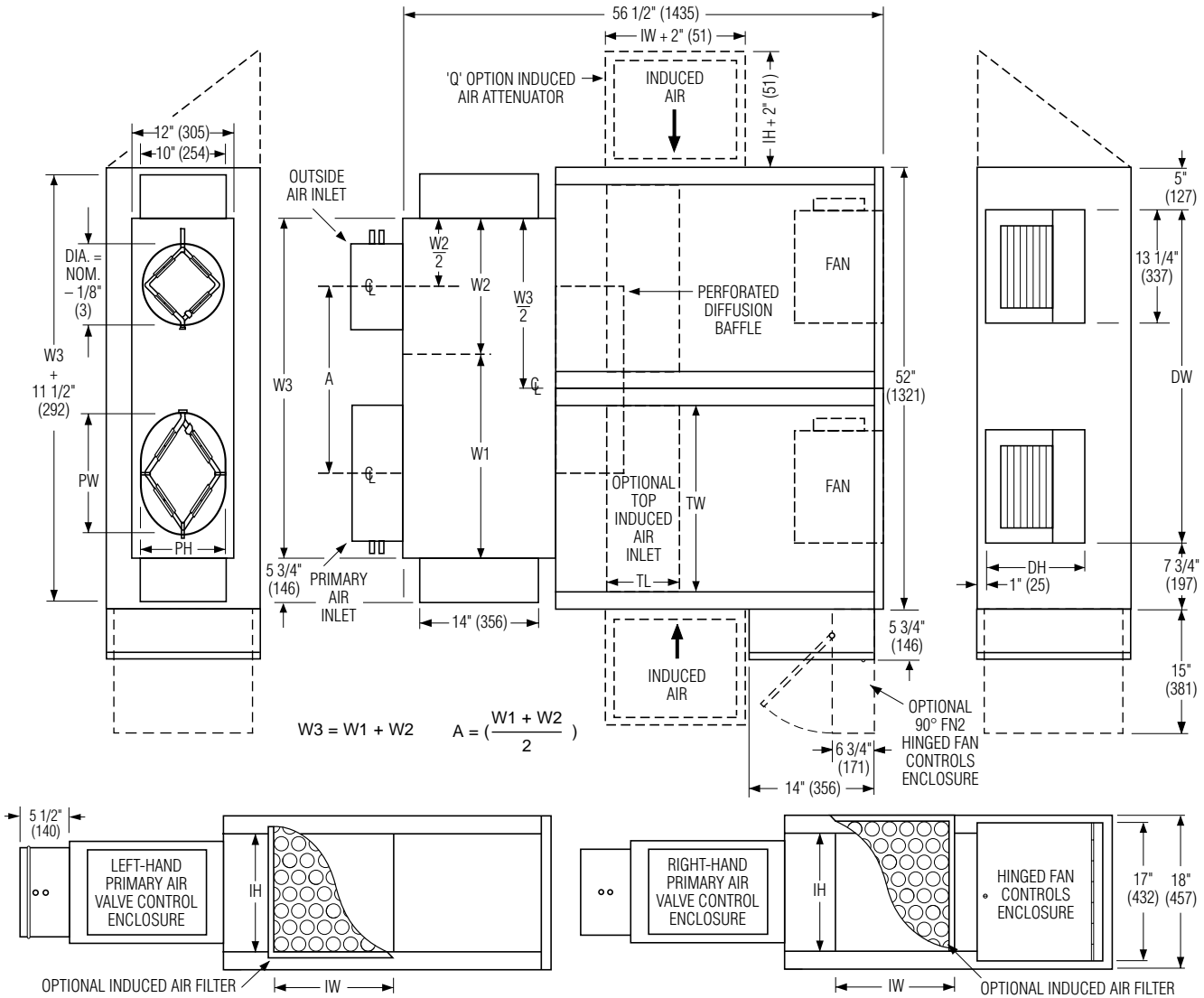

FAN POWERED TERMINAL UNITS

Dimensional Data

Unit Size	Primary Inlet Size	Outside Inlet Size	Induced Air Inlet		Outlet Discharge DW x DH	Filter Size	
			Side (std.) IW x IH	Top (opt.) TL x TW		Side Inlet (std.)	Top Inlet (opt.)
7	12*, 14*, 16* (203*, 254*, 305*)	6, 7, 8, 10 (152, 178, 203, 254)	14 x 14 (356 x 356) Qty. of 2	8 1/2 x 20 (216 x 508) Qty. of 2	39 1/4 x 11 1/2 (997 x 292)	14 x 16 (356 x 406) Qty. of 2	16 x 25 (406 x 635) Qty. of 2

Primary Inlet Dimensions

Size	W1 or W2
12*	18 (457)
14*	24 (610)
16*	28 (711)

Oval Inlet Dimensions

Size	PW x PH
12*	12 13/16 x 9 13/16 (325 x 249)
14*	16 1/16 x 9 13/16 (408 x 249)
16*	16 3/16 x 9 13/16 (487 x 249)

*Flat oval inlets

Dimensions

Model 35S-OAI • Series Flow • Outside Air Inlet

Hot Water Coil Section

Model 35SW-OAI

Available in one, two or three row. Coil section installed on unit discharge. Right hand coil connection looking in direction of airflow standard (shown). Left hand is optional.

Standard Features:

- Coil section installed on unit discharge.
- Coil (and header on multi-circuit units) is installed in insulated casing for increased thermal efficiency.
- 1/2" (13) copper tubes.
- Aluminum ripple fins.
- Sweat Connections:
Size 2 – 3: 1 Row 1/2" (13), 2 and 3 Row 7/8" (22); O.D. male solder.
Size 4 – 6: 1, 2, and 3 Row 7/8" (22); O.D. male solder.
Size 7: 1 and 2 Row, 7/8" (22), 3 Row 1 3/8" (35); O.D. male solder.
- Top and bottom access panels for inspection and coil cleaning.
- Flanged outlet duct connection.

Unit Sizes 2 – 6

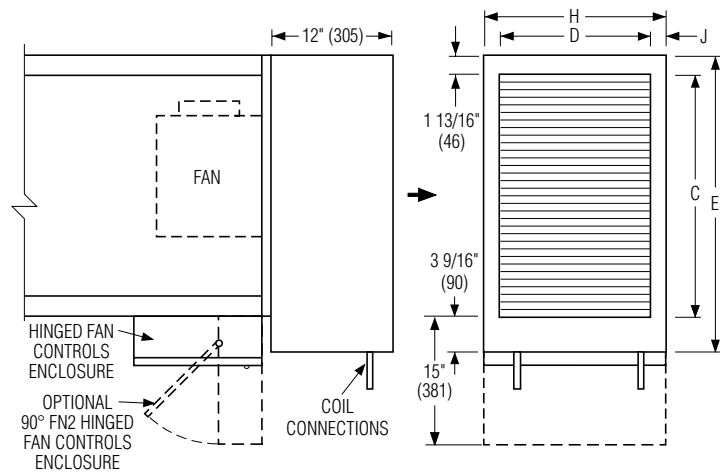

Unit Size 7

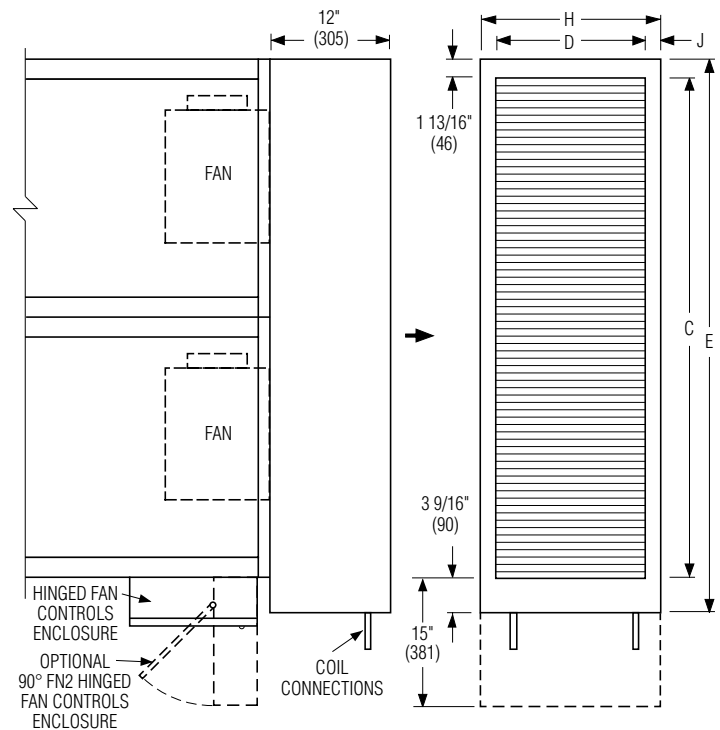

Unit Size	Outlet Duct Size C x D	E	H	J
2	16 x 12 1/8 (406 x 308)	21 3/8 (543)	14 (356)	15/16 (24)
3	16 x 14 7/8 (406 x 378)	21 3/8 (543)	18 (457)	1 9/16 (40)
4, 5	24 x 14 7/8 (610 x 378)	29 3/8 (746)	18 (457)	1 9/16 (40)
6	28 x 17 1/8 (711 x 435)	33 3/8 (848)	19 (483)	15/16 (24)
7	50 x 14 7/8 (1270 x 378)	55 3/8 (1407)	18 (457)	1 9/16 (40)

Dimensions

Model 35S-OAI • Series Flow • Outside Air Inlet

Electric Coil Section

Model 35SE-OAI

Standard Features:

- Unique hinged heater design permits easy access, removal and replacement of heater element without disturbing ductwork.
- Coil installed on unit discharge.
- Insulated coil element wrapper.
- Automatic reset high limit cut-outs (one per element).
- Single point electrical connection (except 600V).
- Magnetic contactors per stage.
- Class A 80/20 Ni/Cr wire.
- Positive pressure airflow switch.
- Flanged outlet duct connection.
- Terminal unit with coil is ETL Listed as an assembly.
- Controls mounted as standard on RH side as shown. Terminals ordered with LH controls (optional) are inverted and discharge duct hanging elevation will therefore change.

Standard Supply Voltage (60 Hz):

- Single phase: 120, 208, 240 & 277V.
- Three phase: 208, 480 (4 wire wye) and 600V (dual point connection).

Options:

- Toggle disconnect switch (includes fan).
- Door interlock disconnect switch.
- SCR Control.
- Mercury contactors.
- Power circuit fusing.
- Dust tight construction.
- Manual reset secondary thermal cut out.

Unit Sizes 2 – 6

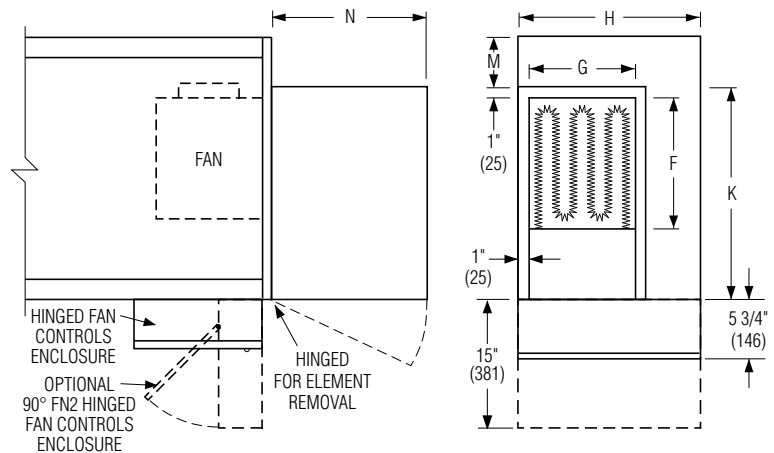

Unit Size 7

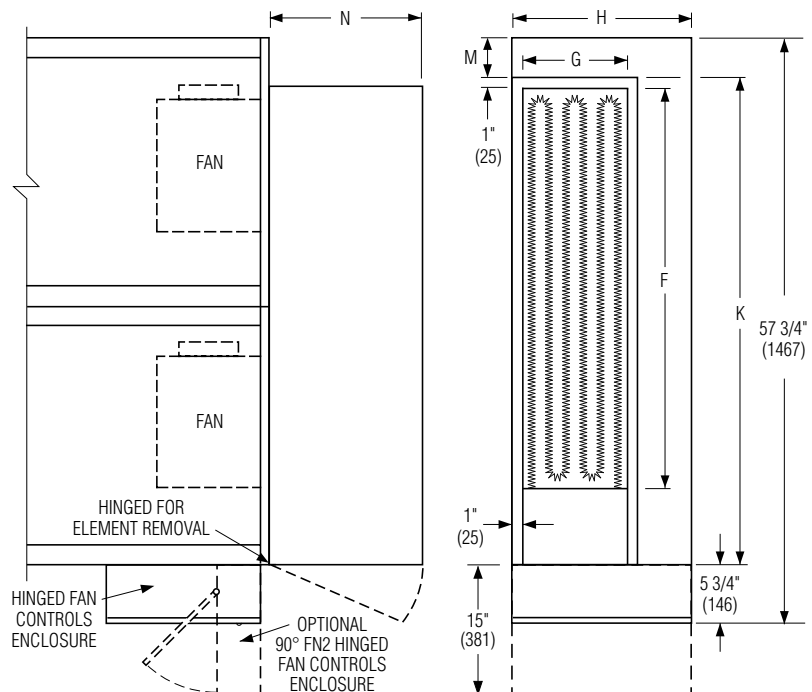

Unit Size	Outlet Duct Size F x G	K	H	M	N
2	10 1/4 x 10 1/2 (260 x 267)	15 1/2 (394)	14 (356)	2 1/2 (64)	12 1/2 (318)
3	10 1/4 x 10 1/2 (260 x 267)	15 1/2 (394)	18 (457)	2 1/2 (64)	15 1/4 (387)
4	13 x 10 1/2 (330 x 267)	21 (533)	18 (457)	5 (127)	15 1/4 (387)
5	14 1/4 x 11 3/4 (362 x 298)	22 (559)	18 (457)	4 (102)	15 1/4 (387)
6	14 1/4 x 11 3/4 (362 x 298)	25 (635)	19 (483)	5 (127)	15 1/4 (387)
7	40 1/4 x 11 3/4 (1022 x 298)	48 (1219)	18 (457)	4 (102)	15 1/4 (387)



Dimensions

Model 35SST-OAI Stealth™ • Series Flow • Outside Air Inlet • Unit Sizes 2 – 6

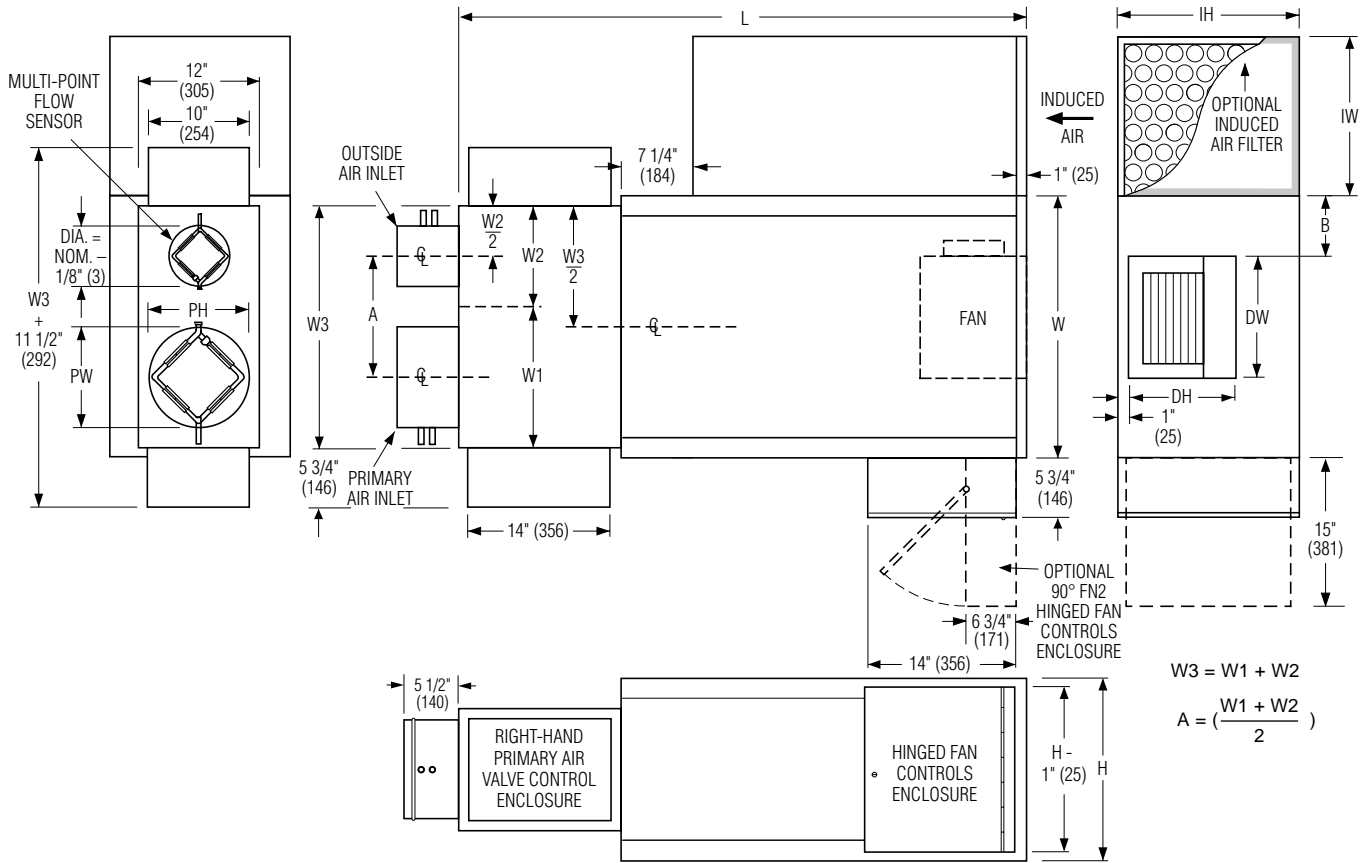

Dimensional Data

Unit Size	Inlet Size	Outside Inlet Size	W	H	L	B	Induced Air Inlet		Outlet Discharge DW x DH	Filter Size Side Inlet (std.)
							Side (std.) IW x IH	Top (opt.) TL x TW		
2	6, 8 (152, 203)	4, 5, 6 (102, 127, 152)	18 (457)	14 (356)	51 1/2 (1308)	6 (152)	9 x 14 (229 x 356)	10 x 14 (254 x 356)	9 1/4 x 10 1/2 (235 x 267)	10 x 14 (254 x 356)
3	6, 8, 10 (152, 203, 254)	4, 5, 6 (102, 127, 152)	18 (457)	18 (457)	51 1/2 (1308)	31/2 (89)	11 x 18 (279 x 457)	14 x 14 (356 x 356)	9 1/4 x 10 1/2 (235 x 267)	12 x 18 (305 x 457)
4	8, 10, 12* (203, 254, 305)	6, 7, 8 (152, 178, 203)	26 (660)	18 (457)	56 1/2 (1435)	6 (152)	15 3/4 x 14 (400 x 356)	12 x 22 (305 x 559)	12 x 10 1/2 (305 x 267)	16 x 14 (406 x 356)
5	10, 12, 14* (254, 305, 356)	6, 7, 8 (152, 178, 203)	26 (660)	18 (457)	56 1/2 (1435)	5 (127)	14 1/2 x 18 (368 x 457)	12 x 22 (305 x 559)	13 1/4 x 11 1/2 (337 x 292)	14 x 18 (356 x 457)
6	10, 12*, 14* (254, 305*, 356*)	6, 7, 8 (152, 178, 203)	30 (762)	19 (483)	59 1/2 (1511)	6 (152)	17 1/2 x 19 (445 x 483)	14 x 26 (356 x 660)	13 1/4 x 11 1/2 (337 x 292)	18 x 19 (457 x 483)

Primary Inlet Dimensions

Size	W1 or W2
4, 5, 6	10 (254)
7, 8	12 (305)
10	14 (356)
12*	18 (457)
14*	24 (610)

Oval Inlet Dimensions

Size	PW x PH
12	12 13/16 x 9 13/16 (325 x 249)
14	16 1/16 x 9 13/16 (408 x 249)

* Flat oval inlets

Dimensions

Model 35SST-OAI Stealth™ • Series Flow • Outside Air Inlet • Unit Sizes 2 – 6

Hot Water Coil Section

Model 35SWST-OAI

Available in one, two or three row. Coil section installed on unit discharge. Right hand coil connection looking in direction of airflow standard (shown). Left hand is optional (terminals are inverted). Connections must be selected same hand as controls enclosure location.

Standard Features:

- Coil section installed on unit discharge.
- Coil (and header on multi-circuit units) is installed in insulated casing for increased thermal efficiency.
- 1/2" (13) copper tubes.
- Aluminum ripple fins.
- 1/2" (13) or 7/8" (22) O. D. sweat connections.
- Top and bottom access panels for inspection and coil cleaning.
- Flanged outlet duct connection.

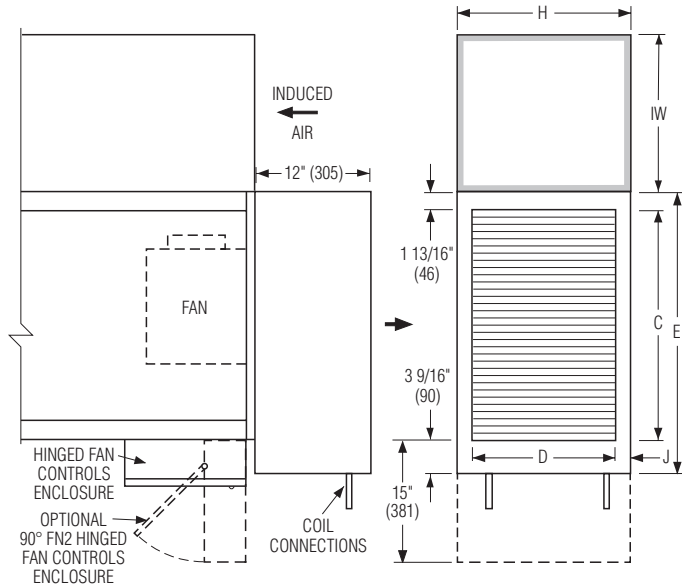

Unit Size	Outlet Duct Size C x D	E	H	J
2	16 x 12 1/8 (406 x 308)	21 3/8 (543)	14 (356)	15/16 (24)
3	16 x 14 7/8 (406 x 378)	21 3/8 (543)	18 (457)	1 9/16 (40)
4, 5	24 x 14 7/8 (610 x 378)	29 3/8 (746)	18 (457)	1 9/16 (40)
6	28 x 17 1/8 (711 x 435)	33 3/8 (848)	19 (483)	15/16 (24)

Electric Coil Section

Model 35SEST-OAI

Standard Features:

- Unique hinged heater design permits easy access, removal and replacement of heater element without disturbing ductwork.
- Coil installed on unit discharge.
- Insulated coil element wrapper.
- Automatic reset high limit cut-outs (one per element).
- Single point electrical connection for entire terminal unit.
- Magnetic contactors per stage.
- Class A 80/20 Ni/Cr wire.
- Positive pressure airflow switch.
- Flanged outlet duct connection.
- Terminal unit with coil is ETL Listed as an assembly.
- Controls mounted as standard on RH side as shown. Terminals ordered with LH controls (optional) are inverted and discharge duct hanging elevation will therefore change.

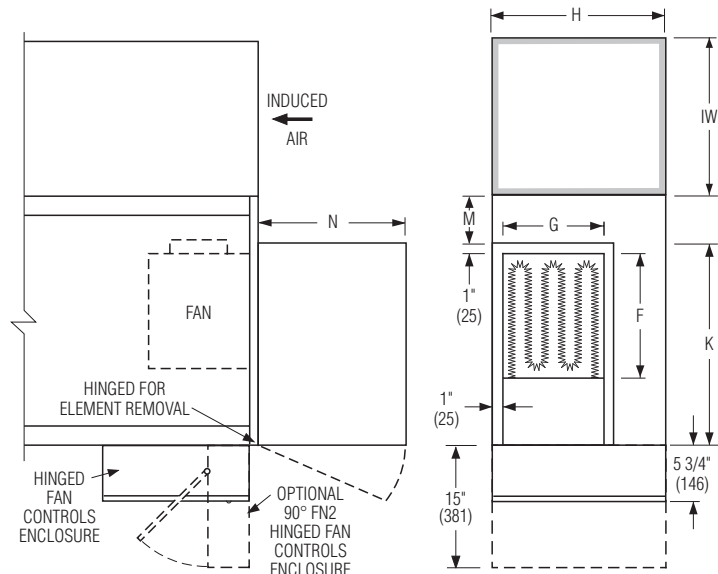

Unit Size	Outlet Duct Size F x G	K	H	M	N
2	10 1/4 x 10 1/2 (260 x 267)	15 1/2 (394)	14 (356)	2 1/2 (64)	12 1/2 (318)
3	10 1/4 x 10 1/2 (260 x 267)	15 1/2 (394)	18 (457)	2 1/2 (64)	15 1/4 (387)
4	13 x 10 1/2 (330 x 267)	21 (533)	18 (457)	5 (127)	15 1/4 (387)
5	14 1/4 x 11 3/4 (362 x 298)	22 (559)	18 (457)	4 (102)	15 1/4 (387)
6	14 1/4 x 11 3/4 (362 x 298)	25 (635)	19 (483)	5 (127)	15 1/4 (387)

**SERIES FLOW
CONSTANT VOLUME
35S SERIES PRESSURIZATION
UNIT**

- CRITICAL ENVIRONMENT APPLICATIONS
- ECM/EPIC Fan Technology®



Model 35SW-CVP

Models:

35S-CVP No Heat

35SE-CVP Electric Heat

35SW-CVP Hot Water Heat

Nailor's **35S Series with CVP** is perfect for use as a pressurization unit for critical environment applications with HEPA filters. Utilizing Nailor's ECM/EPIC Fan Technology®, the fan and blower operate as a pressure independent constant volume assembly. This means that the airflow through the unit will not change due to pressure changes in the system as the filter loads or as the pressure in the exhaust or supply ducts change. The induction port is closed so that the unit operates as a straight through cooling unit. Both electric and hot water reheat options are available. The fan and damper are set to maintain pressure in the room being served. Temperature control is through reheat in the unit. The CVP feature allows designers to take advantage of Nailor's ECM/EPIC Fan Technology® and its associated low operating costs for pressurization.

Smart Brushless DC motor technology provides continuous monitoring, automatic compensation and precise control and maintenance of discharge airflow regardless of discharge static pressure variations incurred by a HEPA filter. Available in three units sizes, suitable for 200 – 3000 cfm (94 – 1416 l/s) zone designs with up to a maximum total external discharge static pressure of 1.0" w.g. (249 Pa).

Ideally, suited for clean room applications such as hospital isolation wards, operating rooms, pharmaceutical and biotechnology manufacturing and research facilities.

STANDARD FEATURES:

- Unique 18 ga. (1.31) galvanized steel channel space frame construction provides extreme rigidity and 20 ga. (1.0) casing components.
- 16 ga. (1.61) galvanized steel inclined opposed blade primary air damper operating on a 45° arc.
- ECM/EPIC Fan Technology®.
- Solid metal IAQ inner liner.
- Pressure independent primary airflow control.
- Multi-point averaging Diamond Flow sensor.
- Terminal is field flippable, providing left or right installation connections. Refer to IOM for details.
- Universal access panels on all four sides of terminal for ease of maintenance and service.

- Motor blower assembly mounted on special 16 ga. (1.61) angles and isolated from casing with rubber isolators.
- Hinged door on fan controls enclosure.
- Available with electric or hot water reheat.
- All controls are mounted on exterior of terminal providing ready access for field adjustment.
- Each terminal factory tested prior to shipment.
- Single point electrical and/or pneumatic main air connection.
- Discharge opening designed for flanged duct connection.
- Full primary air valve low voltage enclosure for factory mounted DDC and analog electronic controls.

Controls:

- Digital controls. Factory mounting and wiring of DDC controls supplied by BMS Controls Contractor.

Options:

- Primary air valve enclosure for field mounted controls.
- Toggle disconnect switch (except units with electric heat, when disconnect is an electric heat option and includes fan).
- Fan unit fusing.
- Hanger brackets.
- FN2 90° Line Voltage enclosure.
- FN3 Remote Line Voltage control enclosure.

Performance Data:

Refer to 35SST Stealth™ data.

Dimensions

Model 35S-CVP • Constant Volume • Pressurization Unit

Unit Sizes 3 & 5

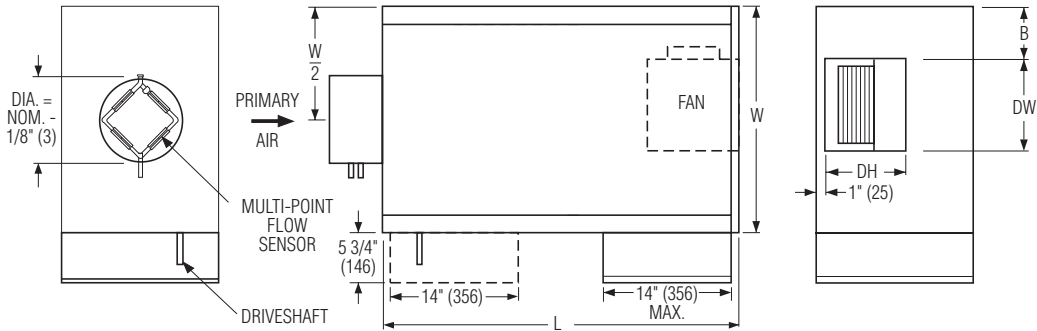

Unit Size 7

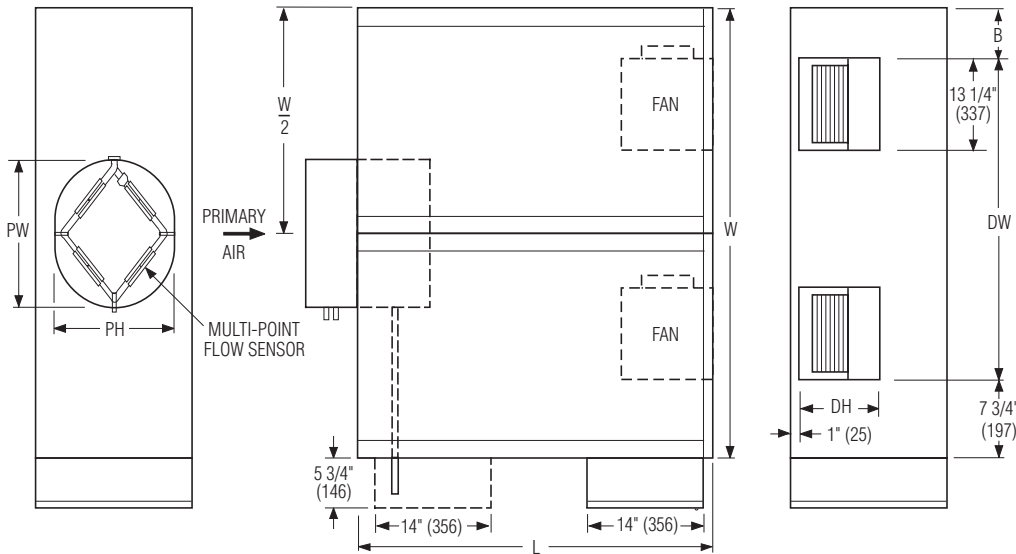

Unit Sizes 3, 5 & 7 Side View

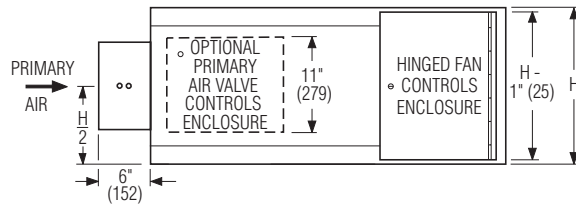

Dimensional Data

Unit Size	Inlet Size	PW x PH	W	H	L	B	Outlet Discharge DW x DH
3	6, 8, 10 (152, 203, 254)	—	18 (457)	18 (457)	36 (914)	3 1/2 (89)	9 1/4 x 10 1/2 (235 x 267)
5	8, 10, 12 (203, 254, 305)	—	26 (660)	18 (457)	41 (1041)	5 (127)	13 1/4 x 11 1/2 (337 x 292)
7	14 (356) rnd. 16 (407) rnd. *18 (457) oval	13 7/8 (352) 15 7/8 (403) 20 3/16 x 13 7/8 (513 x 352)	52 (1321)	18 (457)	41 (1041)	5 (127)	39 1/4 x 11 1/2 (997 x 292)

* Flat oval inlets

FAN POWERED TERMINAL UNITS

Dimensions

Model 35S-CVP • Constant Volume • Pressurization Unit

Hot Water Coil Section

Model 35SW-CVP

Available in one, two or three row. Coil section installed on unit discharge. Right hand coil connection looking in direction of airflow standard (shown). Left hand is optional.

Standard Features:

- Coil section installed on unit discharge.
- Coil (and header on multi-circuit units) is installed in insulated casing for increased thermal efficiency.
- 1/2" (13) copper tubes.
- Aluminum ripple fins.
- Sweat Connections:
 Size 3: 1 Row 1/2" (13), 2 and 3 Row 7/8" (22); O.D. male solder.
 All size: 5 Row 7/8" (22); O.D. male solder.
 Size 7: 1 and 2 Row 7/8" (22), 3 Row 1 3/8" (35); O.D. male solder.
- Top and bottom access panels for inspection and coil cleaning.
- Flanged outlet duct connection.

Unit Sizes 3 and 5

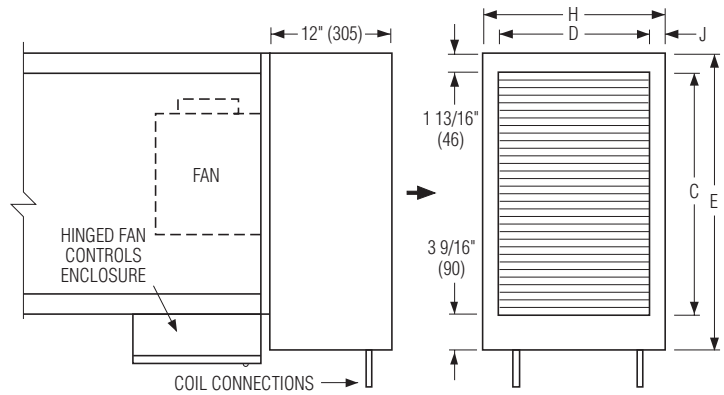

Unit Size 7

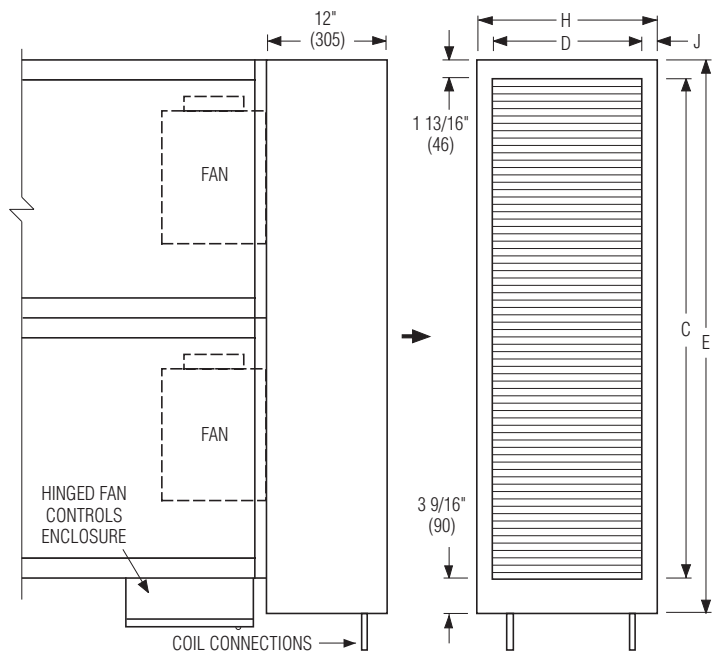

Unit Size	Outlet Duct Size C x D	E	H	J
3	16 x 14 7/8 (406 x 378)	21 3/8 (543)	18 (457)	1 9/16 (40)
5	24 x 14 7/8 (610 x 378)	29 3/8 (746)	18 (457)	1 9/16 (40)
7	50 x 14 7/8 (1270 x 378)	55 3/8 (1407)	18 (457)	1 9/16 (40)

Dimensions

Model 35S-CVP • Series Flow

Electric Coil Section

Model 35SE-CVP

Standard Features:

- Unique hinged heater design permits easy access, removal and replacement of heater element without disturbing ductwork.
- Coil installed on unit discharge.
- Insulated coil element wrapper.
- Automatic reset high limit cut-outs (one per element).
- Single point electrical connection for entire terminal unit.
- Magnetic contactors per stage.
- Class A 80/20 Ni/Cr wire.
- Positive pressure airflow switch.
- Flanged outlet duct connection.
- Terminal unit with coil is ETL Listed as an assembly.
- Controls mounted as standard on RH side as shown. Terminals ordered with LH controls (optional) are inverted and discharge duct hanging elevation will therefore change.

Standard Supply Voltage (60 Hz):

- Single phase: 120, 208, 240 & 277V.
- Three phase: 208, 480 (4 wire wye) and 600V (dual point connection).

Options:

- Toggle disconnect switch (includes fan).
- Door interlock disconnect switch.
- Mercury contactors.
- Power circuit fusing.
- Dust tight construction.
- Manual reset secondary thermal cut out.
- SCR Control.

Unit Sizes 3 and 5

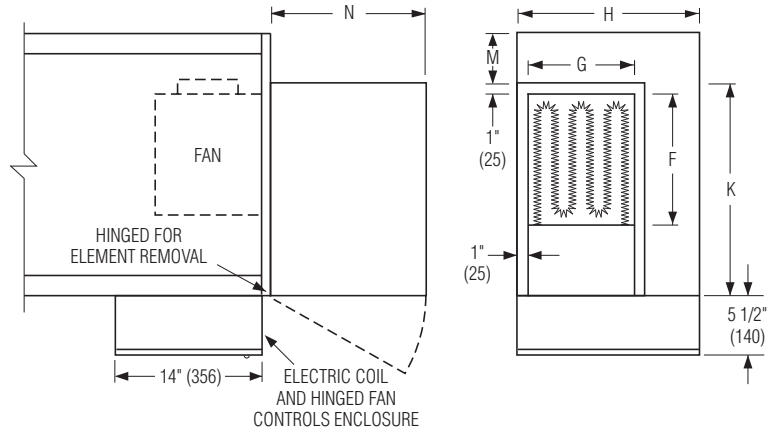

Unit Size 7

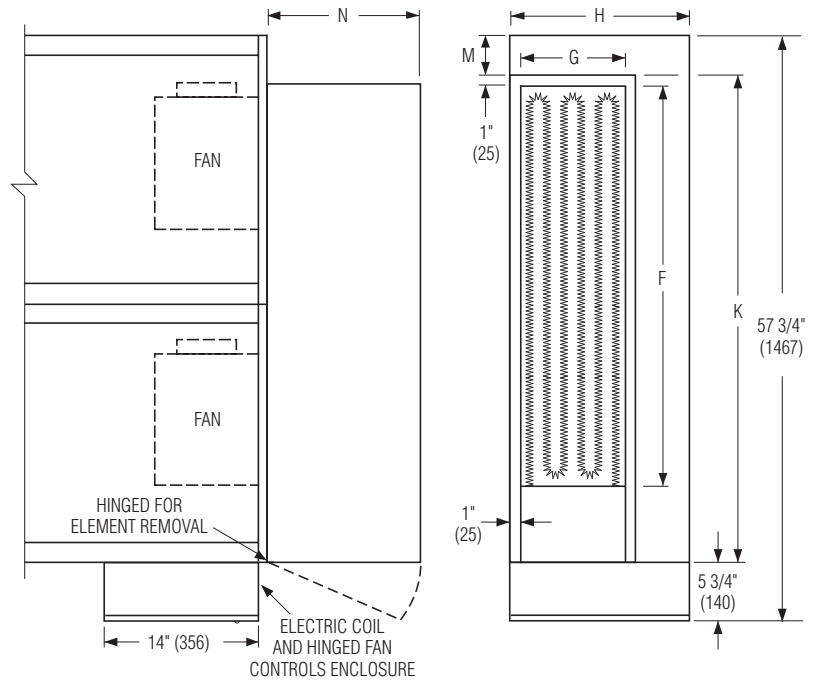

Unit Size	Outlet Duct Size F x G	K	H	M	N
3	10 1/4 x 10 1/2 (260 x 267)	15 1/2 (394)	18 (457)	2 1/2 (64)	15 1/4 (387)
5	14 1/4 x 11 3/4 (362 x 298)	22 (559)	18 (457)	4 (102)	15 1/4 (387)
7	40 1/4 x 11 3/4 (1022 x 298)	48 (1219)	18 (457)	4 (102)	15 1/4 (387)

Performance Data

ECM Motor Fan Curves – Airflow vs. Downstream Static Pressure

35S Series with CVP • Constant Volume • Pressurization Unit

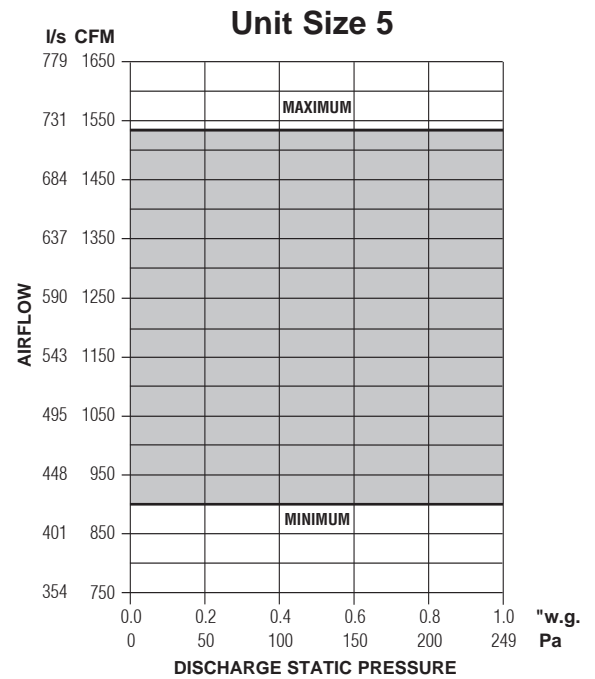
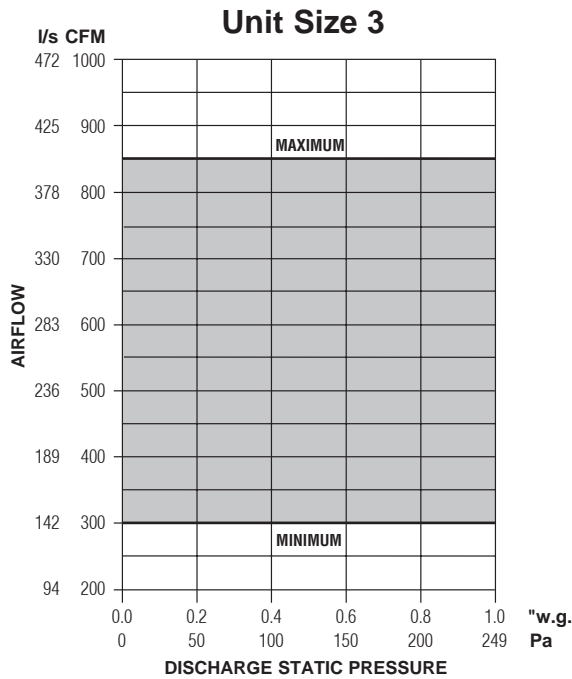

NOTES:

- The ECM is pressure independent and constant volume in operation at factory or field set point within the shaded area. Airflow does not vary with changing static pressure conditions. The motor compensates for any changes in external static pressure or induced air conditions such as filter loading.
- Airflow can be set to operate on horizontal performance line at any point within shaded area using the solid state volume controller provided.
- Fan curves shown are applicable to 120, 208, 240 and 277 volt, single phase ECM's. ECM's, although DC in operation, include a built-in AC/DC converter.

Electrical Data

Unit Size	Motor HP	EPIC ECM Motor FLA			
		120V	208V	240V	277V
3	*	4.8	3.3	3.2	3.1
5	*	9.6	6.2	5.9	5.8
7	*	17.5	11.1	11.4	11.4

* The EPIC ECM is a variable horsepower motor. Refer to Selectworks schedule for actual power consumption. FLA = Full load amperage. All motors are single phase/60 Hz.

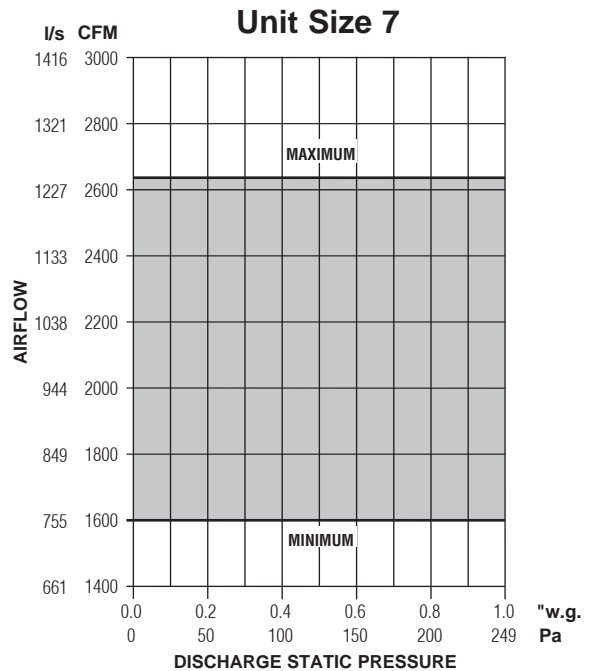

FAN POWERED TERMINAL UNITS

Performance Data • Hot Water Coil

Models: 35SW, 35SWST, 35SW-OAI, 35SWST-OAI, 35SW-CVP • Series Flow

Unit Size 1

1 Row (single circuit)

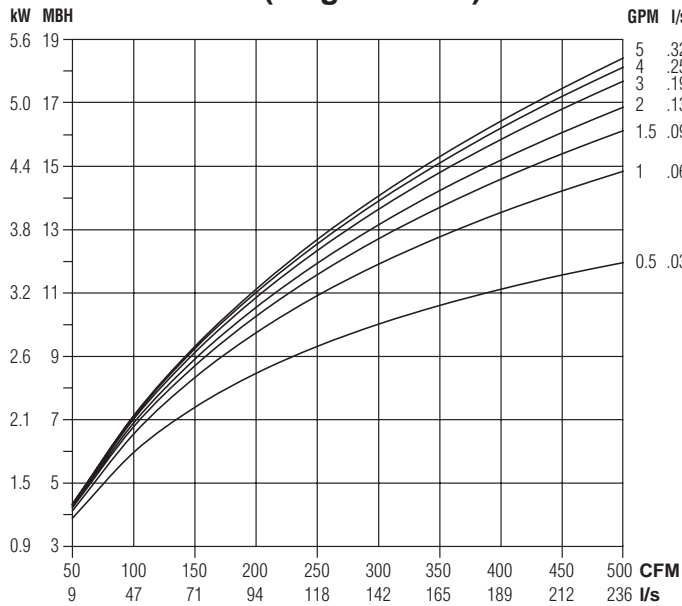

2 Row (multi-circuit)

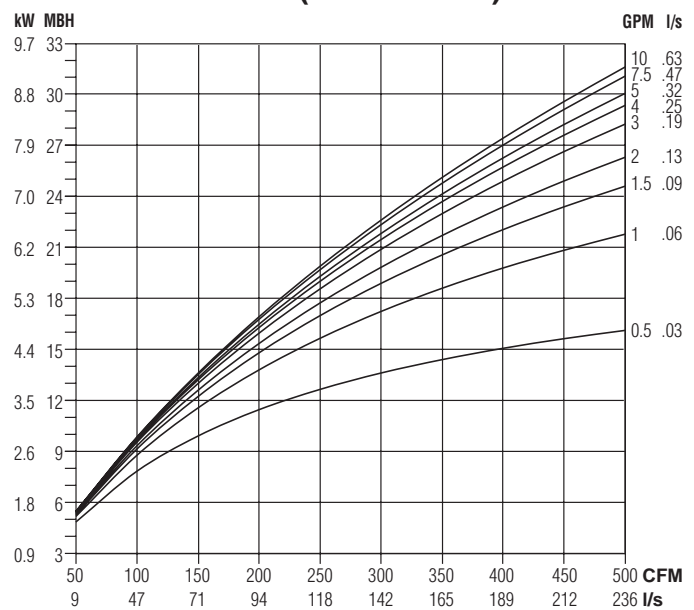

3 Row (multi-circuit)

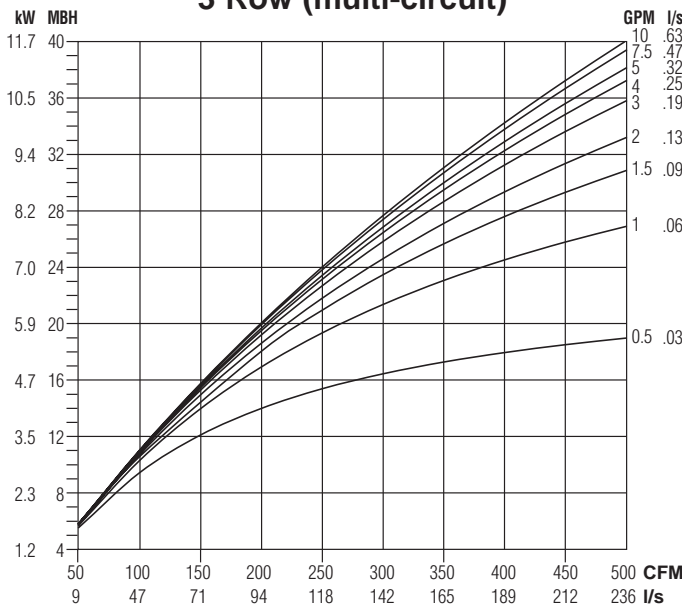

Water Pressure Drop

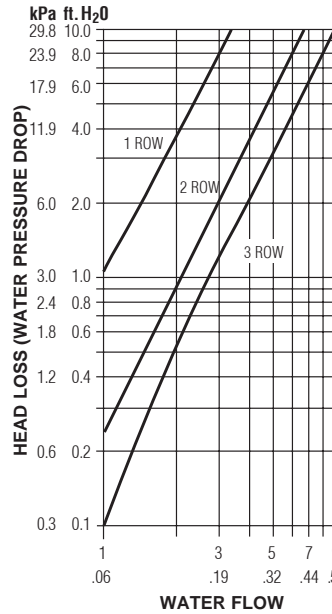

Air Pressure Drop

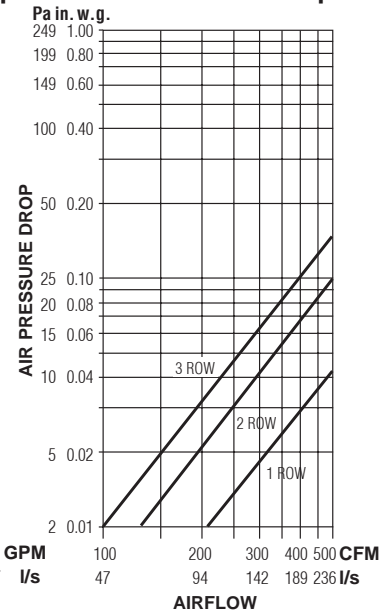

NOTES:

- Capacities are in MBH (kW), **thousands of Btu per hour (kiloWatts)**.
- MBH (kW) values are based on a Δt (temperature difference) of 110°F (61°C) between entering air and entering water. For other Δt 's; multiply the MBH (kW) values by the factors below.
- Air Temperature Rise.
 $ATR (^{\circ}F) = 927 \times \frac{MBH}{cfm}$, $ATR (^{\circ}C) = 829 \times \frac{kW}{l/s}$
- Water Temp. Drop.
 $WTD (^{\circ}F) = 2.04 \times \frac{MBH}{GPM}$, $WTD (^{\circ}C) = .224 \times \frac{kW}{l/s}$
- Connections: 1 Row 1/2" (13), 2 and 3 Row 7/8" (22); O.D. male solder.

Altitude Correction Factors:

Altitude ft. (m)	Sensible Heat Factor
0 (0)	1.00
2000 (610)	0.94
3000 (914)	0.90
4000 (1219)	0.87
5000 (1524)	0.84
6000 (1829)	0.81
7000 (2134)	0.78

Correction factors at other entering conditions:

Δt °F (°C)	50 (28)	60 (33)	70 (39)	80 (44)	90 (50)	100 (56)	110 (61)	120 (67)	130 (72)	140 (78)	150 (83)
Factor	.455 (.459)	.545 (.541)	.636 (.639)	.727 (.721)	.818 (.820)	.909 (.918)	1.00 (1.00)	1.09 (1.10)	1.18 (1.18)	1.27 (1.28)	1.36 (1.36)



FAN POWERED TERMINAL UNITS

Performance Data • Hot Water Coil

Models: 35SW, 35SWST, 35SW-OAI, 35SWST-OAI, 35SW-CVP • Series Flow

Unit Size 2

1 Row (single circuit)

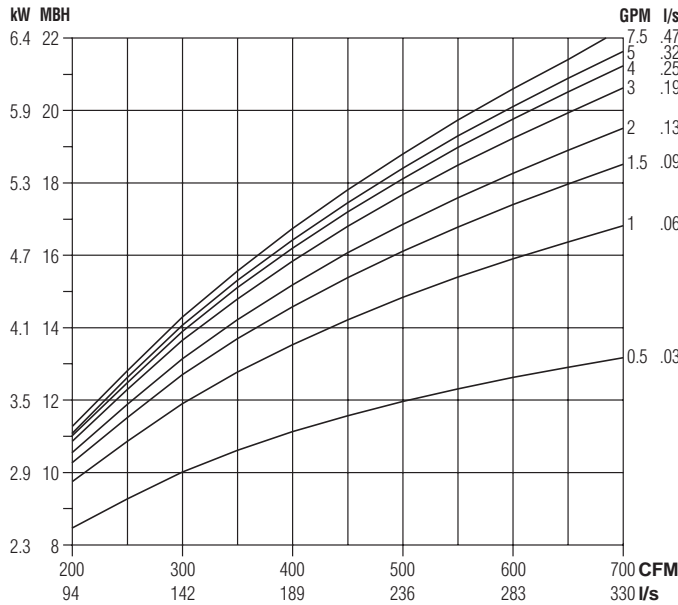

2 Row (multi-circuit)

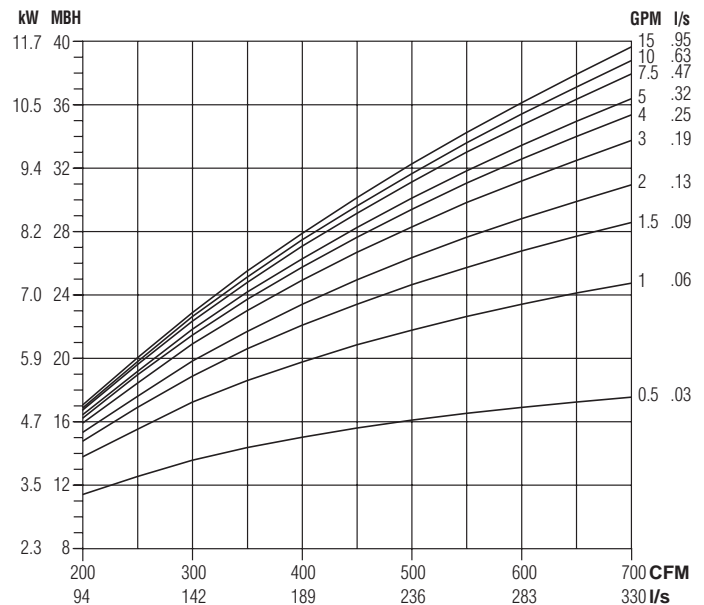

3 Row (multi-circuit)

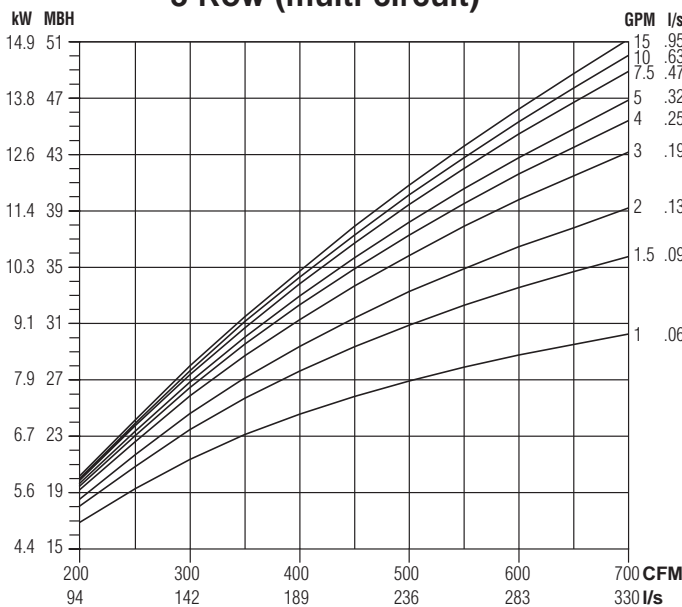

Water Pressure Drop

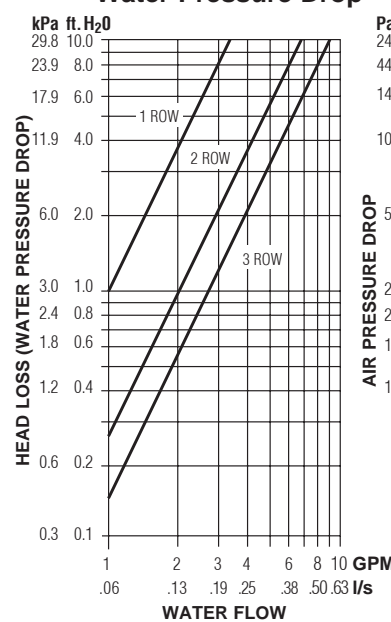

Air Pressure Drop

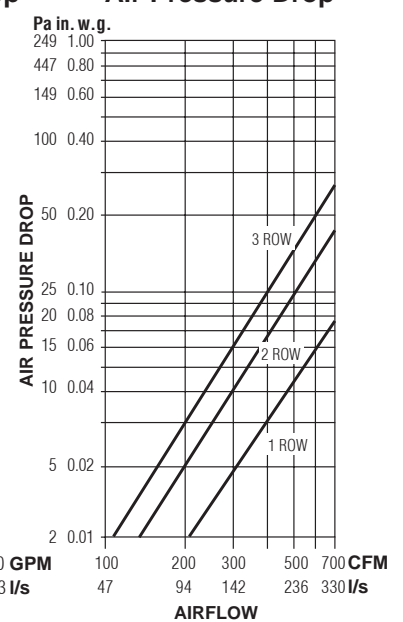

NOTES:

- Capacities are in MBH (kW), *thousands of Btu per hour (kiloWatts)*.
- MBH (kW) values are based on a Δt (temperature difference) of 110°F (61°C) between entering air and entering water. For other Δt 's; multiply the MBH (kW) values by the factors below.

- Air Temperature Rise.

$$\text{ATR (}^\circ\text{F)} = 927 \times \frac{\text{MBH}}{\text{cfm}}, \text{ ATR (}^\circ\text{C)} = 829 \times \frac{\text{kW}}{\text{l/s}}$$

- Water Temp. Drop.

$$\text{WTD (}^\circ\text{F)} = 2.04 \times \frac{\text{MBH}}{\text{GPM}}, \text{ WTD (}^\circ\text{C)} = .224 \times \frac{\text{kW}}{\text{l/s}}$$

- Connections: 1 Row 1/2" (13), 2 and 3 Row 7/8" (22); O.D. male solder.

Altitude Correction Factors:

Altitude ft. (m)	Sensible Heat Factor
0 (0)	1.00
2000 (610)	0.94
3000 (914)	0.90
4000 (1219)	0.87
5000 (1524)	0.84
6000 (1829)	0.81
7000 (2134)	0.78

Correction factors at other entering conditions:

Δt °F (°C)	50 (28)	60 (33)	70 (39)	80 (44)	90 (50)	100 (56)	110 (61)	120 (67)	130 (72)	140 (78)	150 (83)
Factor	.455 (.459)	.545 (.541)	.636 (.639)	.727 (.721)	.818 (.820)	.909 (.918)	1.00 (1.00)	1.09 (1.10)	1.18 (1.18)	1.27 (1.28)	1.36 (1.36)

Performance Data • Hot Water Coil

Models: 35SW, 35SWST, 35SW-OAI, 35SWST-OAI, 35SW-CVP • Series Flow

Unit Size 3

1 Row (single circuit)

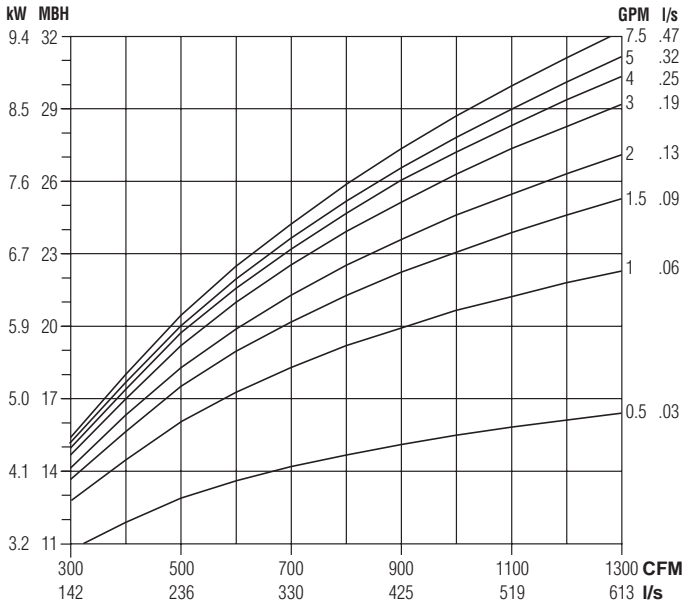

2 Row (multi-circuit)

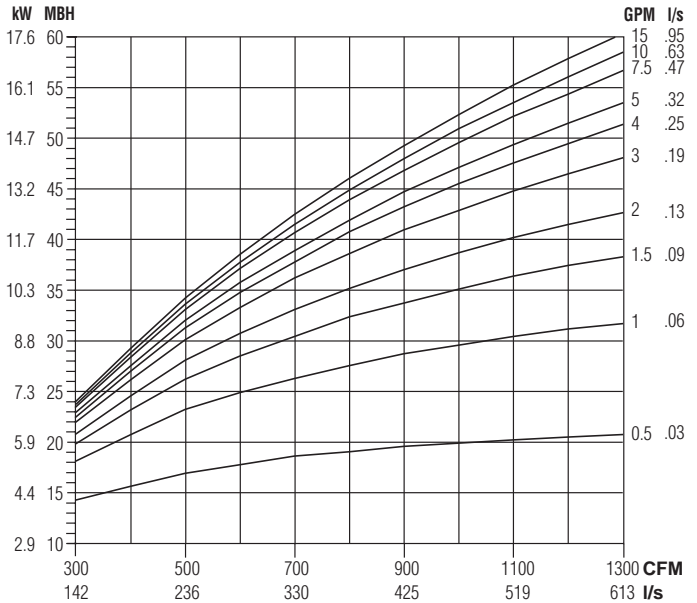

3 Row (multi-circuit)

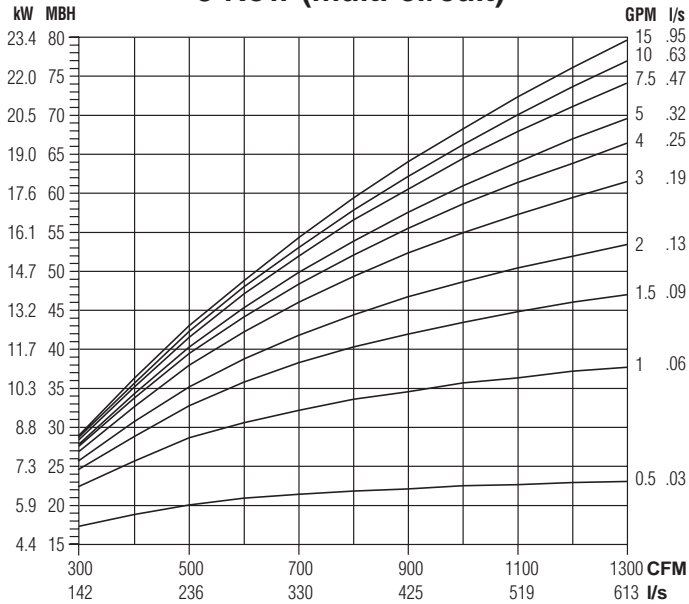

Water Pressure Drop

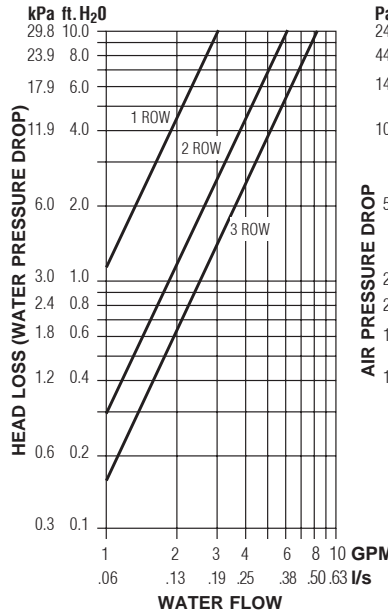

Air Pressure Drop

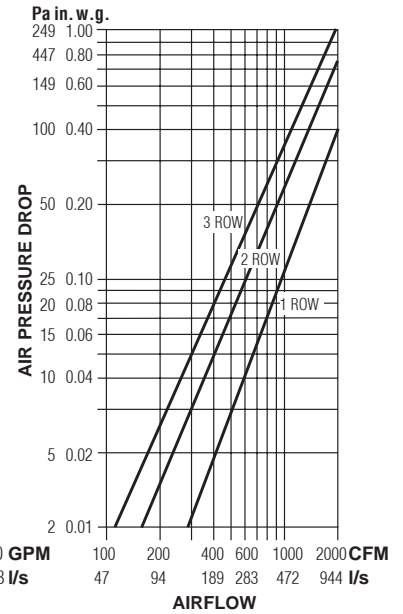

NOTES:

- Capacities are in MBH (kW), *thousands of Btu per hour (kiloWatts)*.
- MBH (kW) values are based on a Δt (temperature difference) of 110°F (61°C) between entering air and entering water. For other Δt 's; multiply the MBH (kW) values by the factors below.

- Air Temperature Rise.

$$\text{ATR (}^\circ\text{F)} = 927 \times \frac{\text{MBH}}{\text{cfm}}, \text{ATR (}^\circ\text{C)} = 829 \times \frac{\text{kW}}{\text{l/s}}$$

- Water Temp. Drop.

$$\text{WTD (}^\circ\text{F)} = 2.04 \times \frac{\text{MBH}}{\text{GPM}}, \text{WTD (}^\circ\text{C)} = .224 \times \frac{\text{kW}}{\text{l/s}}$$

- Connections: 1 Row 1/2" (13), 2 and 3 Row 7/8" (22); O.D. male solder.

Altitude Correction Factors:

Altitude ft. (m)	Sensible Heat Factor
0 (0)	1.00
2000 (610)	0.94
3000 (914)	0.90
4000 (1219)	0.87
5000 (1524)	0.84
6000 (1829)	0.81
7000 (2134)	0.78

Correction factors at other entering conditions:

Δt °F (°C)	50 (28)	60 (33)	70 (39)	80 (44)	90 (50)	100 (56)	110 (61)	120 (67)	130 (72)	140 (78)	150 (83)
Factor	.455 (.459)	.545 (.541)	.636 (.639)	.727 (.721)	.818 (.820)	.909 (.918)	1.00 (1.00)	1.09 (1.10)	1.18 (1.18)	1.27 (1.28)	1.36 (1.36)

Performance Data • Hot Water Coil

Models: 35SW, 35SWST, 35SW-OAI, 35SWST-OAI, 35SW-CVP • Series Flow

Unit Sizes 4 & 5

1 Row (multi-circuit)

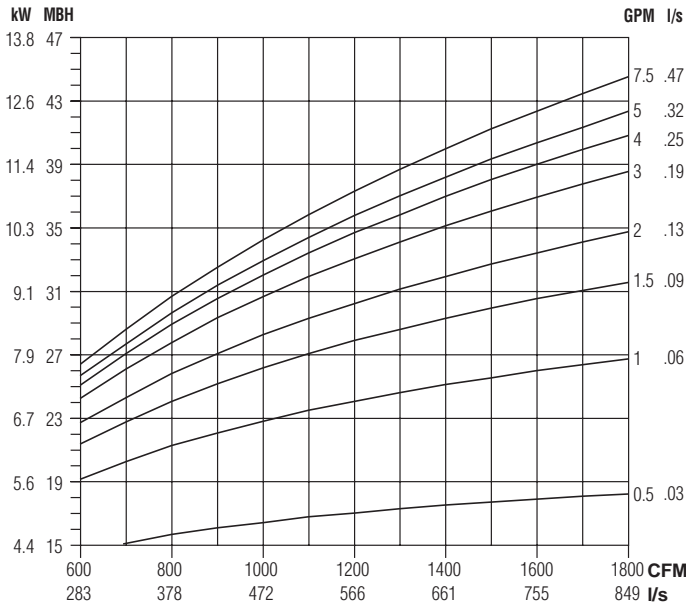

2 Row (multi-circuit)

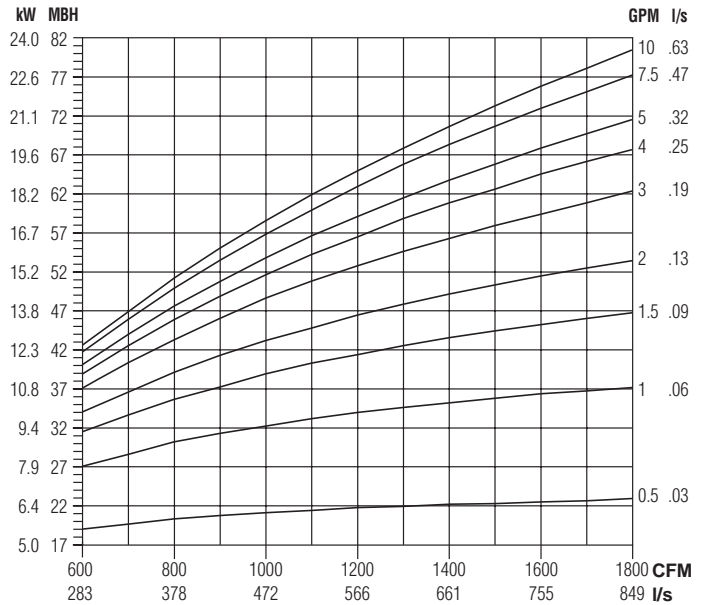

3 Row (multi-circuit)

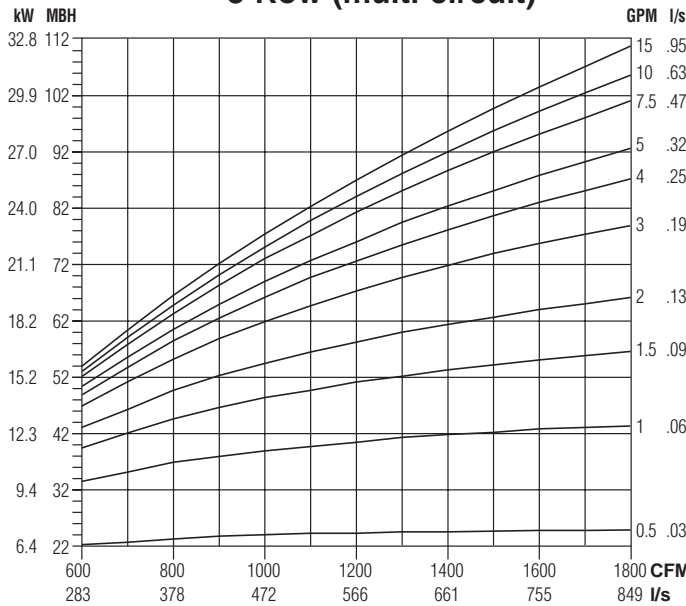

Water Pressure Drop

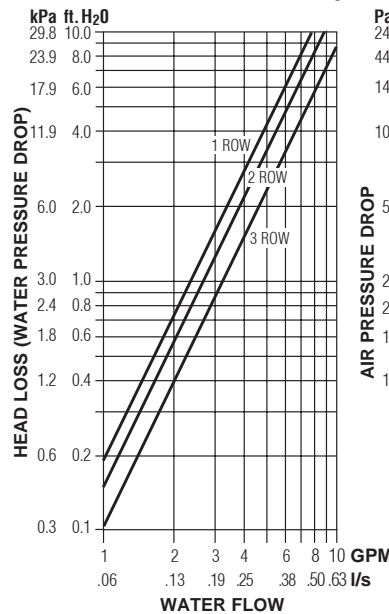

Air Pressure Drop

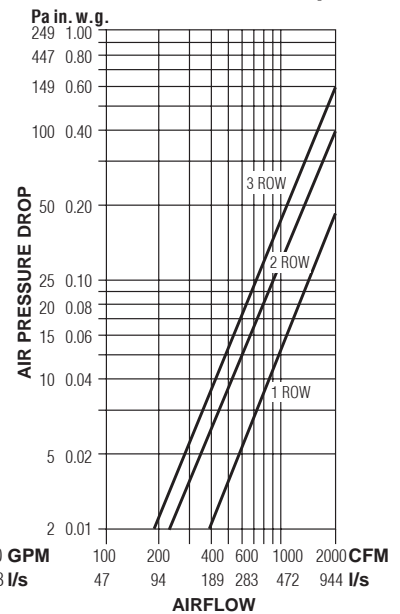

NOTES:

- Capacities are in MBH (kW), *thousands of Btu per hour (kiloWatts)*.
- MBH (kW) values are based on a Δt (temperature difference) of 110°F (61°C) between entering air and entering water. For other Δt 's; multiply the MBH (kW) values by the factors below.

- Air Temperature Rise.
 $ATR (^\circ F) = 927 \times \frac{MBH}{cfm}$, $ATR (^\circ C) = 829 \times \frac{kW}{l/s}$
- Water Temp. Drop.
 $WTD (^\circ F) = 2.04 \times \frac{MBH}{GPM}$, $WTD (^\circ C) = .224 \times \frac{kW}{l/s}$
- Connections: 1, 2 and 3 Row 7/8" (22); O.D. male solder.

Altitude Correction Factors:

Altitude ft. (m)	Sensible Heat Factor
0 (0)	1.00
2000 (610)	0.94
3000 (914)	0.90
4000 (1219)	0.87
5000 (1524)	0.84
6000 (1829)	0.81
7000 (2134)	0.78

Correction factors at other entering conditions:

Δt °F (°C)	50 (28)	60 (33)	70 (39)	80 (44)	90 (50)	100 (56)	110 (61)	120 (67)	130 (72)	140 (78)	150 (83)
Factor	.455 (.459)	.545 (.541)	.636 (.639)	.727 (.721)	.818 (.820)	.909 (.918)	1.00 (1.00)	1.09 (1.10)	1.18 (1.18)	1.27 (1.28)	1.36 (1.36)

Performance Data • Hot Water Coil

Models: 35SW, 35SWST, 35SW-OAI, 35SWST-OAI, 35SW-CVP • Series Flow

Unit Size 6

1 Row (multi-circuit)

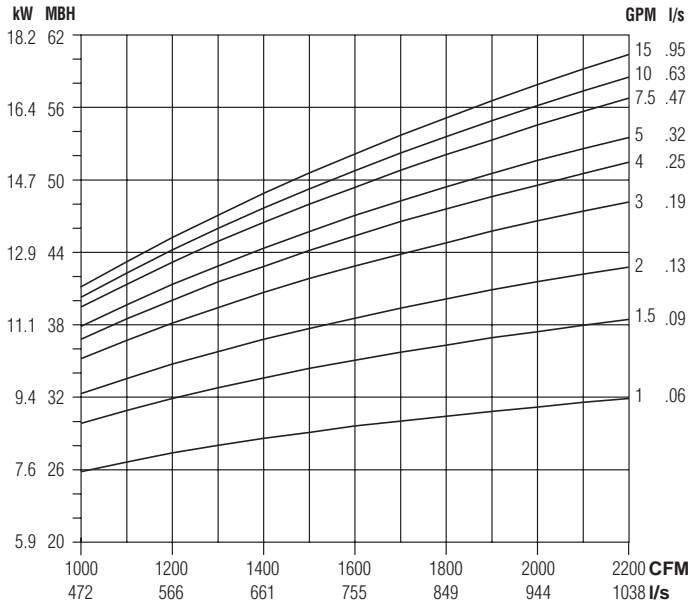

2 Row (multi-circuit)

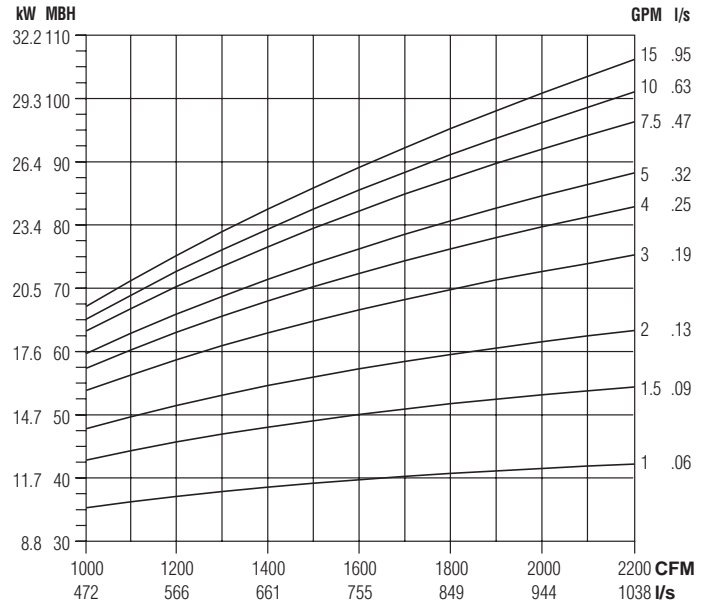

3 Row (multi-circuit)

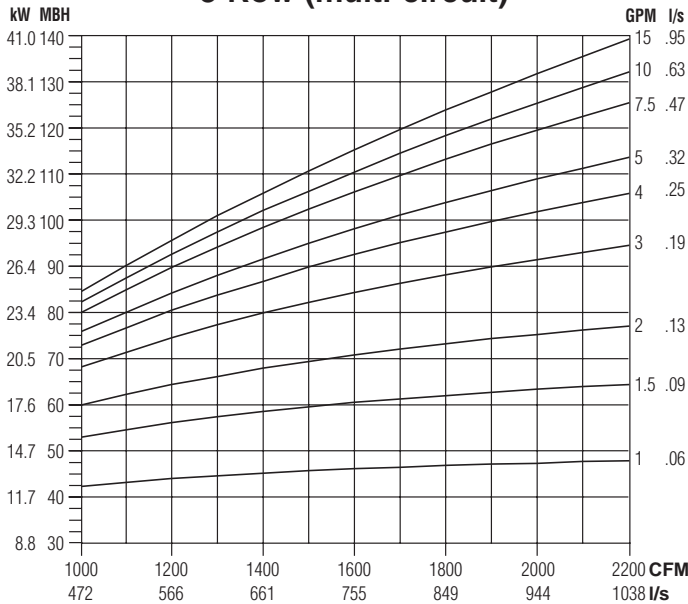

Water Pressure Drop

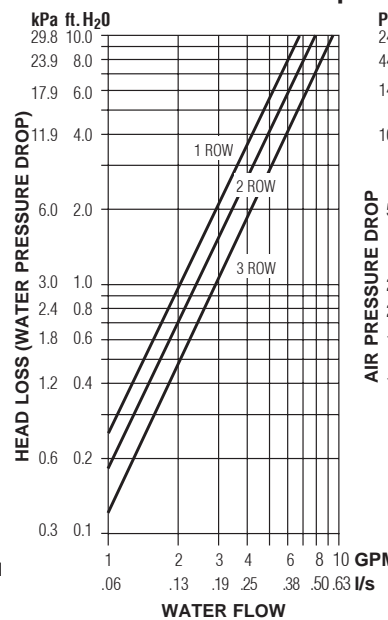

Air Pressure Drop

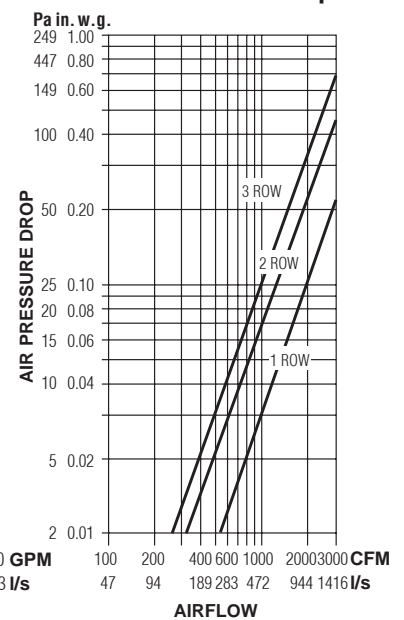

NOTES:

- Capacities are in MBH (kW), *thousands of Btu per hour (kiloWatts)*.
- MBH (kW) values are based on a Δt (temperature difference) of 110°F (61°C) between entering air and entering water. For other Δt 's; multiply the MBH (kW) values by the factors below.
- Air Temperature Rise.
 $ATR (^{\circ}F) = 927 \times \frac{MBH}{cfm}$, $ATR (^{\circ}C) = 829 \times \frac{kW}{l/s}$
- Water Temp. Drop.
 $WTD (^{\circ}F) = 2.04 \times \frac{MBH}{GPM}$, $WTD (^{\circ}C) = .224 \times \frac{kW}{l/s}$
- Connections: 1, 2 and 3 Row 7/8" (22); O.D. male solder.

Altitude Correction Factors:

Altitude ft. (m)	Sensible Heat Factor
0 (0)	1.00
2000 (610)	0.94
3000 (914)	0.90
4000 (1219)	0.87
5000 (1524)	0.84
6000 (1829)	0.81
7000 (2134)	0.78

Correction factors at other entering conditions:

Δt °F (°C)	50 (28)	60 (33)	70 (39)	80 (44)	90 (50)	100 (56)	110 (61)	120 (67)	130 (72)	140 (78)	150 (83)
Factor	.455 (.459)	.545 (.541)	.636 (.639)	.727 (.721)	.818 (.820)	.909 (.918)	1.00 (1.00)	1.09 (1.10)	1.18 (1.18)	1.27 (1.28)	1.36 (1.36)

FAN POWERED TERMINAL UNITS

Performance Data • Hot Water Coil

Models: 35SW, 35SWST, 35SW-OAI, 35SWST-OAI, 35SW-CVP • Series Flow

Unit Size 7

1 Row (multi-circuit)

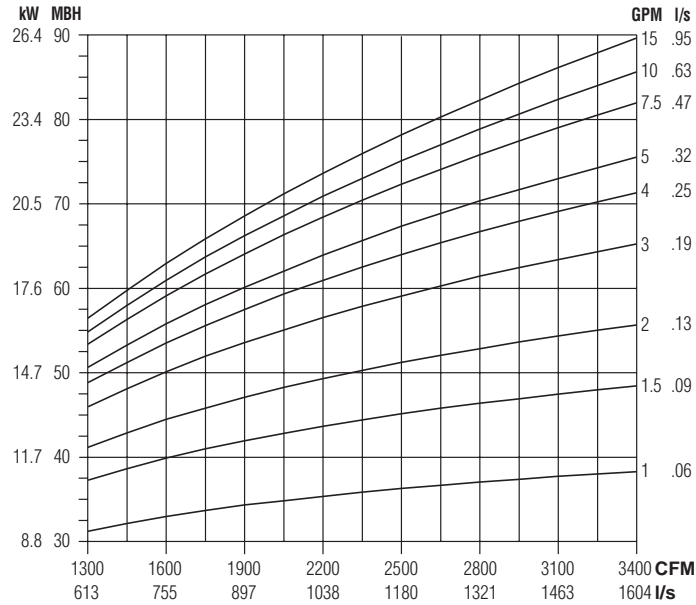

2 Row (multi-circuit)

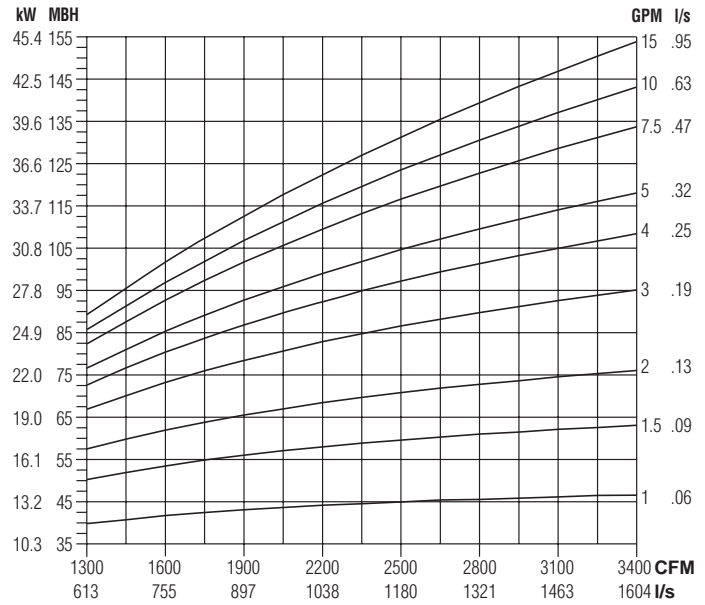

3 Row (multi-circuit)

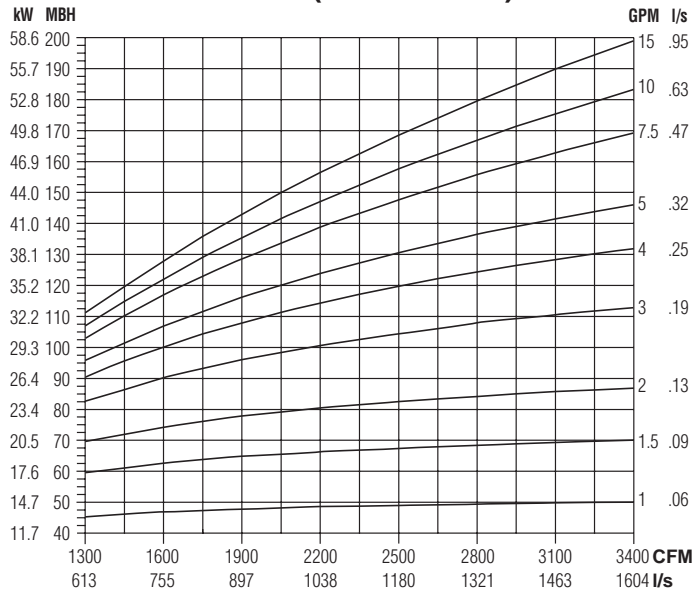

Water Pressure Drop

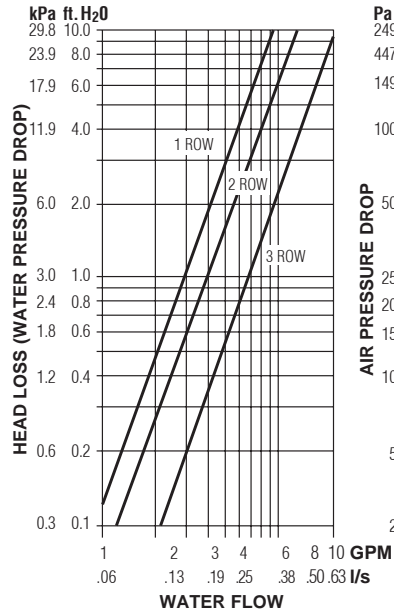

Air Pressure Drop

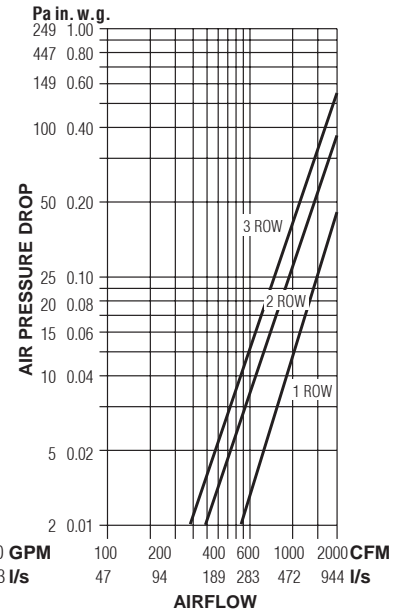

NOTES:

- Capacities are in MBH (kW), *thousands of Btu per hour (kiloWatts)*.
- MBH (kW) values are based on a Δt (temperature difference) of 110°F (61°C) between entering air and entering water. For other Δt 's; multiply the MBH (kW) values by the factors below.

- Air Temperature Rise.

$$\text{ATR (}^\circ\text{F)} = 927 \times \frac{\text{MBH}}{\text{cfm}}, \text{ ATR (}^\circ\text{C)} = 829 \times \frac{\text{kW}}{\text{l/s}}$$

- Water Temp. Drop.

$$\text{WTD (}^\circ\text{F)} = 2.04 \times \frac{\text{MBH}}{\text{GPM}}, \text{ WTD (}^\circ\text{C)} = .224 \times \frac{\text{kW}}{\text{l/s}}$$

- Connections: 1 and 2 Row 7/8" (22), 3 Row 1 3/8" (35); O.D. male solder.

Altitude Correction Factors:

Altitude ft. (m)	Sensible Heat Factor
0 (0)	1.00
2000 (610)	0.94
3000 (914)	0.90
4000 (1219)	0.87
5000 (1524)	0.84
6000 (1829)	0.81
7000 (2134)	0.78

Correction factors at other entering conditions:

Δt °F (°C)	50 (28)	60 (33)	70 (39)	80 (44)	90 (50)	100 (56)	110 (61)	120 (67)	130 (72)	140 (78)	150 (83)
Factor	.455 (.459)	.545 (.541)	.636 (.639)	.727 (.721)	.818 (.820)	.909 (.918)	1.00 (1.00)	1.09 (1.10)	1.18 (1.18)	1.27 (1.28)	1.36 (1.36)

SERIES FLOW VARIABLE VOLUME FAN OPERATION

35SXC STEALTH XC SERIES

- EXPOSED CEILING APPLICATIONS
- SUPER QUIET OPERATION

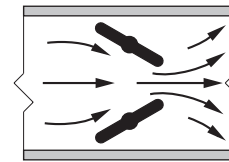

Inclined opposed blade damper configuration minimizes noisy turbulence and provides smooth, accurate, near linear flow control.

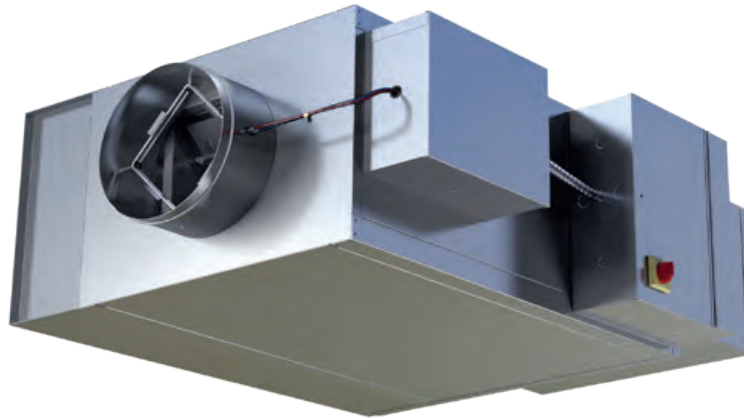

Model 35SEXC

Models:

- 35SXC** No Heat
- 35SEXC** Electric Heat
- 35SWXC** Hot Water Heat

The **35SXC Stealth XC Series** is designed to produce the lowest radiated sound power levels for a series unit in the industry. The **Stealth XC** installed in an exposed ceiling application has the same room sound level as an original **Stealth** unit installed above a ceiling. When paired with a variable volume control sequence, the **Stealth XC** delivers the lowest sound and highest efficiency HVAC system on the market today.

STANDARD FEATURES:

- ECM/EPIC Fan Technology®.
- Unique 18 ga. (1.31) galvanized steel channel space frame construction provides extreme rigidity and 20 ga. (1.0) casing components.
- 16 ga. (1.61) galvanized steel inclined opposed blade primary air damper. 45° rotation, CW to close. 1/2" (13) dia. plated steel drive shaft. An indicator mark on the end of the shaft shows damper position. Leakage is less than 2% of nominal flow at 3" w.g. (750 Pa).
- Steri-liner insulation. 13/16" (21) thick, 4 lb./sq. ft. (64 kg/m³) density rigid fiberglass with alum. FSK facing. Meets requirements of NFPA 90A and UL 181.
- Stealth XC turned induced air silencer provides significant reductions in radiated sound levels. Perforated galvanized steel baffles contain fiberglass acoustic media.
- Perforated baffle on primary air discharge optimizes mixing with induced air for rapid and effective temperature equalization. The baffle also converts low frequency primary air valve generated sound into more readily attenuated higher frequencies.
- Pressure independent primary Diamond airflow control.
- Multi-point averaging Diamond Flow sensor.

- Regardless of factory orientation, the unit can be field installed with either right hand or left hand configuration by turning the unit over.
- Universal access panels on three sides of terminal for ease of maintenance and service.
- Motor blower assembly mounted on special 16 ga. (1.61) angles and isolated from casing with rubber isolators.
- Hinged door on fan controls enclosure.
- 13/16" (21), foil faced 4 lb. density Steri-Liner insulation. Meets requirements of NFPA 90A and UL 181.
- Available with electric or hot water supplementary heat.
- All controls are mounted on exterior of terminal providing ready access for field adjustment.
- Each terminal factory tested prior to shipment.
- Single point electrical connection.
- Discharge opening designed for flanged duct connection.
- Full primary air valve low voltage NEMA 1 type enclosure for factory mounted DDC controls.

Controls:

- Digital controls. Factory mounting and wiring of DDC controls supplied by BMS Controls Contractor.

Options:

- Primary air valve enclosure for field mounted controls.
- Induced air filter, 1" (25) thick, disposable type.
- Toggle disconnect switch (except units with electric heat, when disconnect is an electric heat option and includes fan).
- Various IAQ linings are available.
- Fan unit fusing.
- Hanger brackets.
- FN2 90° Line Voltage enclosure.
- FN3 Remote Line Voltage control enclosure with pre-wired umbilical cord.



Intertek



Control Sequences • Fan Powered Terminal Units

Model Series 35SXC Stealth XC

HVAC Systems are designed to handle the maximum cooling and heating loads throughout the year, though they operate at part load conditions most of the time. 80% of building operating loads are below 50% of design in cooling and 30% of design in heating. Considering part load conditions is critical for optimizing comfort and energy use when choosing a terminal unit control sequence.

Traditional Constant Volume FPTU Control Sequence

When they were initially introduced to the market place, series VAV FPTUs were operated with continuous running and constant volume fans. The VAV damper supplied cooled air for the zone, which mixed with the induced plenum air upstream of the fan. The result was a constant airflow to the zone with a variable temperature in the cooling mode due to the variable primary air. In the heating mode, heaters were usually single stage, but larger heaters had two stage operation. At that time, the constant airflow was considered to provide the highest level of comfort for the occupants.

Advanced Variable Volume FPTU Control Sequence

With the advent of better controls motor designs it became possible to modulate the fans as well as the VAV section. ASHRAE Research Project 1515 verified that human comfort was not compromised with lower airflow rates sometimes as low as 0.2 cfm/ft² rather than the typical design of 1.0 cfm/ft². This process allowed the fan to run at maximum cooling providing the design discharge air, and then reduce plenum airflow somewhat parallel to the reduction of primary air. The target was to achieve about a 60°F. discharge air temperature at the changeover from cooling to deadband. This process dramatically reduced the amount of reheat supplied by the ceiling return as well as significantly reducing the fan motor energy used. This sequence is included in ASHRAE Guideline 36. This allowed the airflow to be constantly adjusted to meet the instantaneous loads in the space with different maximum and minimum airflows for each mode, cooling, deadband and heating. The energy savings shows up in reduced water flows and cooling loads due to the reduction in reheat going to the zone in cooling mode.

Variable vs. Constant - Energy Savings

The obvious energy savings from using a variable control sequence come from the modulation of the terminal unit fan. As the fan speed slows, the energy use reduces exponentially. What is not so obvious is the energy savings from the air handling unit, chillers, and pumps.

Consider a room at part-load conditions in the cooling mode served by a fan-powered terminal unit operating with either a constant volume or variable volume control sequence. The sequences require different quantities of primary air to maintain the space temperature. The constant volume terminal unit induces large amounts of plenum air into the airflow, increasing its temperature. Requiring additional primary air to maintain comfort. The same unit with a variable sequence requires less primary air because there is little induction and the air delivered to the space will be very close to 55°.

Reducing the primary air saves fan energy from the air handling unit, chilled water flow from the pumps, and work by the chillers. Selecting a variable volume sequence impacts the energy use of the entire HVAC system. Depending on the location of the building, the savings could be up to 7.5% of the total building energy use.

The 35SXC Stealth XC Unit provides these benefits while significantly reducing radiated sound, resulting in the most energy and acoustically efficient system on the market today.

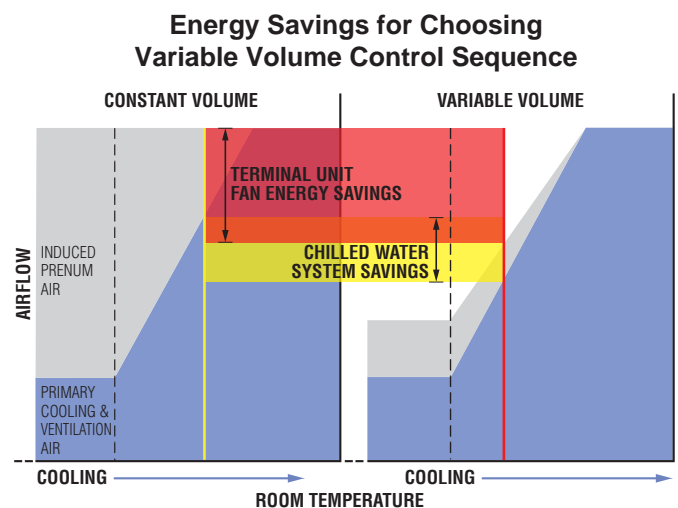
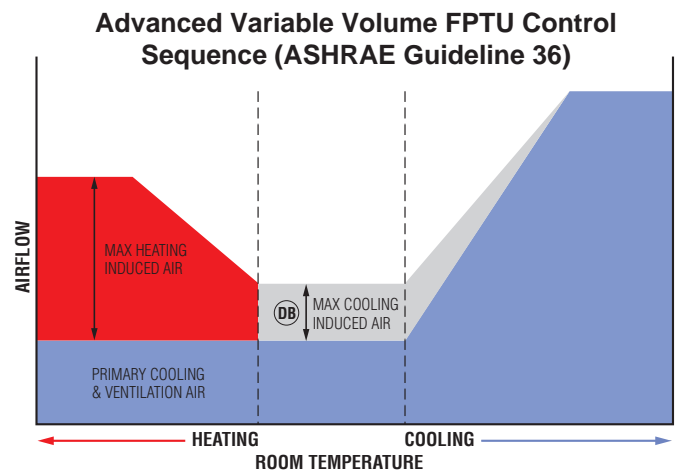
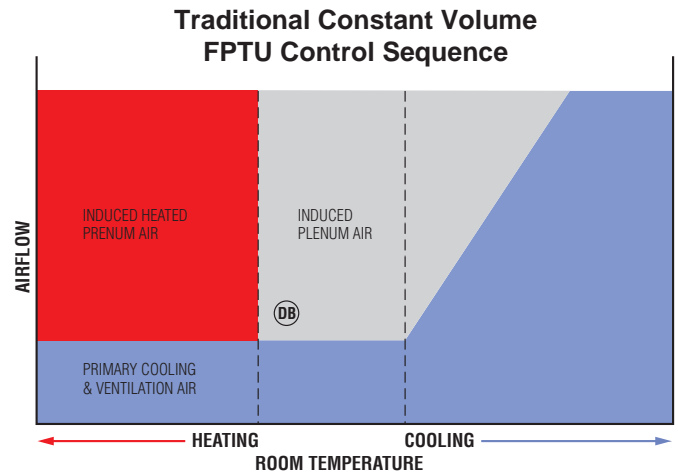

A Series Fan Powered Box for Exposed Ceiling Applications • Model Series 35SXC

Acoustical Privacy in exposed ceiling applications

Architectural designs with open offices and acoustical tile suspended ceilings often have relatively low sound level requirements to achieve "acoustical privacy" for the occupants. The architectural advantages of an exposed ceiling can be debated, but the fact is that they are a reality, often in prime spaces. Acoustical quality is part of the overall value of the space, and acoustical consultants are often employed to assist in achieving this goal. The removal of the acoustical tiles, however, has exposed design issues seldom considered in the past. Besides changing the overall acoustical nature of the space in terms of sound transmission from sources in the space itself, sound reverberation times, and the effects on air distribution and thermal comfort, the lack of an acoustical barrier between the occupant and overhead mechanical equipment has made it necessary to reconsider the selection criteria of noise making HVAC equipment.

Sound distribution in exposed ceiling applications

When the suspended ceiling is not present to help in absorbing sound generated both in the occupied space and from above the occupied space, the resultant acoustical environment in the occupied space becomes more sensitive to sound generated by the mechanical equipment and other sound generating equipment in the space above the occupied zone. According to the ASHRAE / AHRI RP755 research project, a suspended ceiling tends to create an "Area Source" for all sounds generated in the ceiling plenum space. This tends to both lower the overall level of sound measured throughout the space, and to spread the apparent source of the sound over a broad area.

Stealth units for suspended ceilings applications: 35SST

The basis of acoustical design for mechanical equipment is octave band sound power measured in a Reverberation Chamber as defined by ISO, ASHRAE and AHRI standards. These chambers can develop sound power ratings for equipment isolated from associated ductwork and are the basis for certification of VAV products under AHRI Standard 880. The 35SST Stealth Series Fan terminal has been successful in providing superior acoustical environments with suspended ceilings on many projects based on witnessed tests in the ceiling mock-up facility and follow up tests in actual spaces.

Importance of a new design for exposed ceiling applications

Comparison testing between suspended ceiling and without suspended ceiling in the same mock-up, it was found that the traditional frequency distribution of the space attenuation was quite different from the traditional suspended acoustical tile ceilings. While the critical frequencies for suspended ceiling applications tend to be in the 125 to 250 Hz bands, it was found that the critical frequencies, those that determine NC, or even RC ratings, are at higher frequencies. So, in order to optimize the sound frequency generation of equipment designed for exposed ceilings, different construction and attenuation characteristics needed to be developed.

The quietest fan powered box design for exposed ceiling applications - Model Series 35SXC

Obviously, if a Fan Terminal can deliver more air and still meet the acoustical requirements, this would be a benefit to the building owner. To accomplish this, however, it was necessary to discover where the sound comes from. It had been known that about half the acoustical energy created by an operating Series (or Parallel) fan terminal comes out the induction port, the rest is radiated from the unit casing itself. It was found that placing silencers on the induction port only reduced the total sound generation slightly, often by only 3dB in critical frequencies. Additionally, for silencers to become more effective, they tend to require a higher rpm on the supply fan to overcome the increased pressure drop created by the silencer. This increases the fan generated noise, and the power required, often making additional silencing counterproductive.

After several years of research and development, Nailor has designed a series fan terminal specially designed to operate in an exposed ceiling environment, the 35SXC (Stealth XC/ Stealth with exposed ceiling). Utilizing a highly effective inlet silencer along with carefully integrated interior construction elements, a design has been created that has an acoustical profile that complements the observed space attenuation found with exposed ceilings.

Difference between 35SST and 35SXC

The result is an acoustical signature that closely follows the NC curves in several frequencies. The following graph illustrates the difference between the 35SST (Stealth) and the 35SXC (Stealth XC) in exposed ceiling mock-up tests.

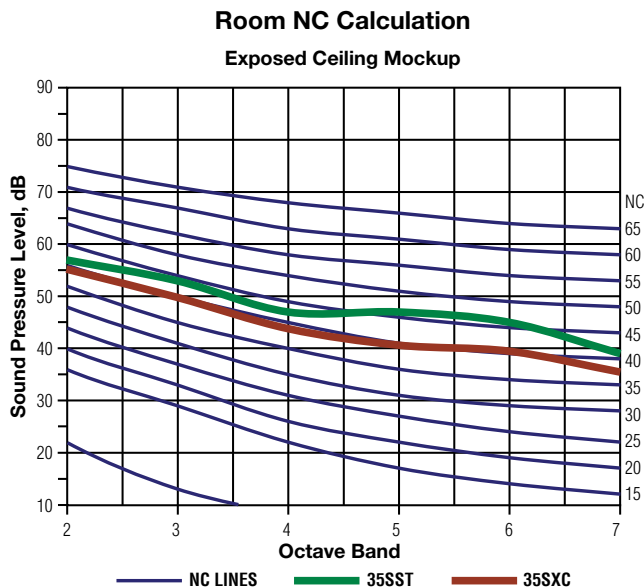

Figure 1. Room NC and RC Comparison (35SST vs. 35SXC)

FAN POWERED TERMINAL UNITS



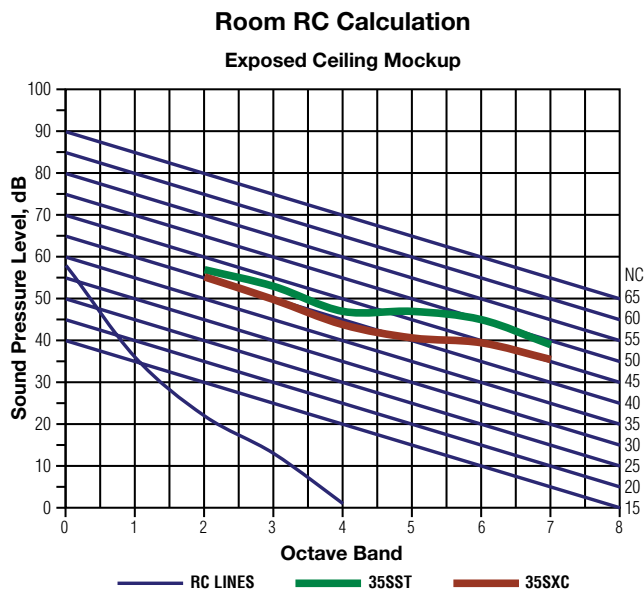

Figure 2. 35SST and 35SXC Comparison Mockup room

In a standard environment the stealth could have a slightly lower NC, but in an exposed ceiling environment, it would likely result in a measured NC almost 5 or more higher. This is typical of most quiet Series (or Parallel) fan box designs. In addition, the data, in this example, results in a RC-41N (neutral) spectra in this mock-up test.

When employed in an exposed ceiling environment, it has been found that the airflow must be significantly reduced to lower the sound generated by even the quietest fan terminals to achieve desired sound levels. This results in more and oversized units being required to deliver the required airflow to the space. Experience has shown that the actual cost of installing a Series Fan Terminal, not counting the cost of the unit itself, can cost around \$10,000/unit when commissioning, DDC controls, piping, wiring and associated ductwork is considered.

By creating this acoustical signature, it is possible to use close to the same number of terminals as with a suspended ceiling to deliver the same air quantities to the space. With traditional quiet boxes, the airflow would have to be reduced by 25% or more to achieve the same NC sound levels in the space, adding significantly to the installed cost compared to the 35SXC design. In addition, the room sound level with the XC design will be an RC-Neutral, helping to overcome the "hissy" sound that results with most fan box designs when there is no ceiling to absorb high frequency sounds coming from above the occupied space, allowing for a design of NC=40-45 where an NC=35-40 is more often required to achieve the same "acoustical quality" with a suspended acoustical tile ceiling.

Problem with using AHRI 885 recommended sound deductions for exposed ceiling applications

AHRI Standard 885 has a recommended procedure for estimating sound when there is an exposed ceiling. This was part of the standard when published in the late 90's and suggested that one could treat a radiated sound source as a point source, increase the room volume to account for the now exposed plenum, and input distance and volume in the same manner as a discharge sound source or diffuser. This technique has been found to grossly underestimate the resultant space sound pressure, as shown in the following graph, likely because it fails to account for the now significant effects of supply and discharge ductwork and

other sound sources in the upper part of the space. In this test, measured NC was found to be 5 NC higher than predicted, and set in the 3rd to 6th octave bands, instead of the 2nd.

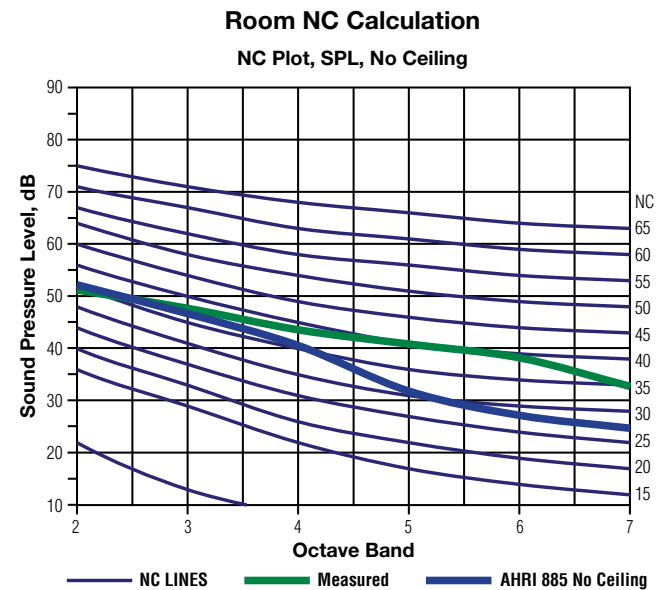

Figure 3. Measured vs estimated sound using AHRI 885 method for exposed plenums

The trend towards building office space without an acoustical tile ceiling is on the rise. The lack of the acoustical ceiling above an occupied office space poses new challenges to providing an acceptable acoustical environment in the occupied space. This challenge is particularly difficult for the manufacturers of HVAC equipment in the space. Derating equipment to achieve acceptable noise levels in the occupied space causes smaller zones and higher associated first costs.

AHRI has developed an application standard, AHRI 885, which includes the primary sound paths for most commercial office spaces and has established a set of required default values which can be used for comparing different manufacturer's data on an equivalent basis, identified in Appendix E of the standard. The AHRI default radiated sound path includes an acoustical tile ceiling. When there is no acoustical tile ceiling, however, AHRI does not provide much guidance, stating only "For spaces with no acoustical ceiling, the sound attenuation of radiated sound should be calculated using the equation for Table D16...", which does not specify enough input parameters to approximate a universal table. Manufacturers are, therefore, free to create their own "transfer functions". **Appendix E was created 30 years ago to avoid this situation.** Testing in the acoustical mock-up at the Houston Energistics Research Laboratory has shown that measured sound was much higher than predicted by the table. In some cases, the measured reduction from sound power has been less than 5dB in mid and high frequencies, rather than the predicted 15dB.

Extensive testing at Energistics, as well as tests in actual facilities conducted by acoustical consultants, has led Nailor to develop a new Series Fan Terminal product, the 35SXC, which has an optimally tuned radiated sound frequency spectrum that provides greatly reduced space sound levels in an exposed ceiling plenum environment. As an added benefit the measured frequency spectrum of an installed unit is found to closely follow the ASHRAE RC curves for a neutral spectrum.

Data is provided on Discharge sound NC per AHRI 885 Appendix E at the flow rate shown. Radiated NC sound is based on mock-up tests conducted in the Energistics Laboratory.

Dimensions

Model Series 35SXC Stealth XC • Series Flow • Unit Sizes 1, 3, 5

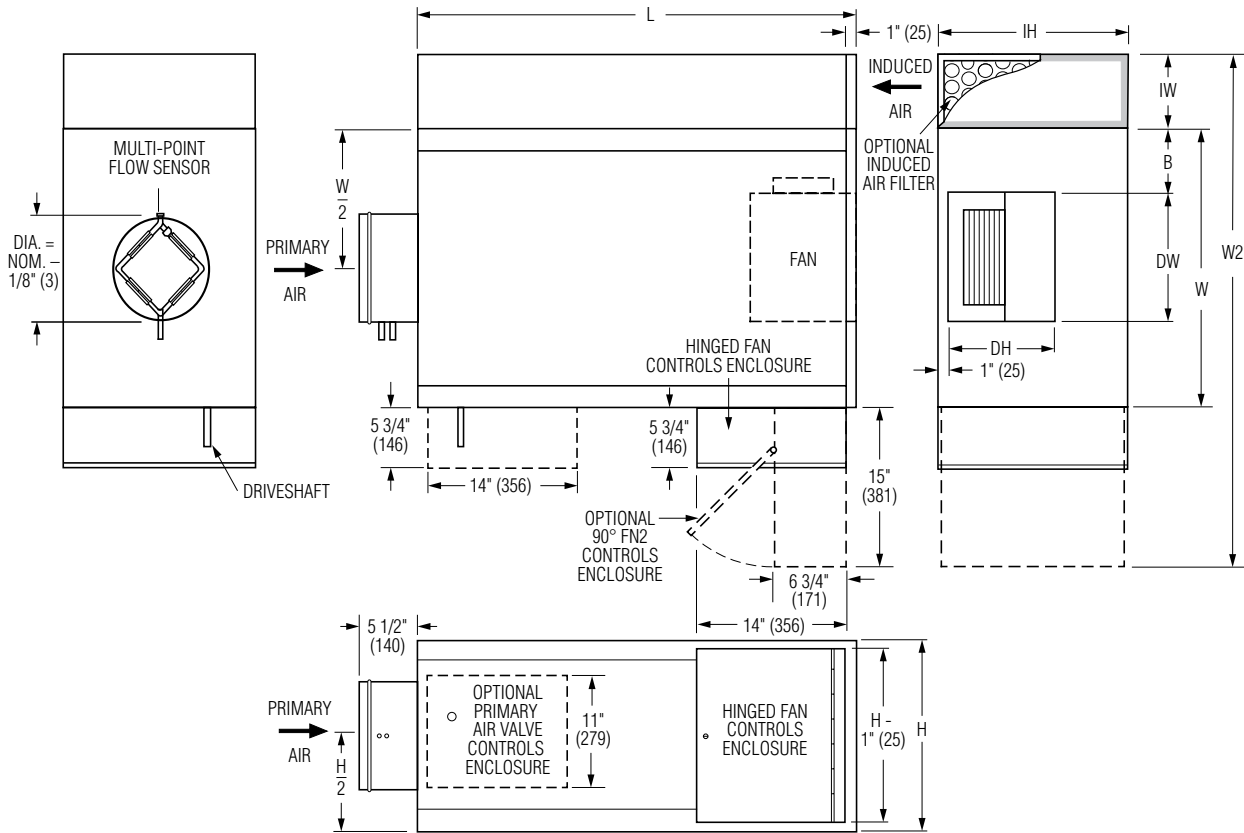

Dimensional Data

Unit Size	Inlet Size	W	W2	H	L	B	Induced Air Inlet IW x IH	Outlet Discharge DW x DH	Filter Size
1	4, 5, 6, 8 (102, 127, 152, 203)	20 (508)	41 (1041)	14 (356)	36 (914)	6 (152)	6 x 14 (152 x 356)	8 1/8 x 4 1/4 (206 x 108)	6 x 14 (152 x 356)
3	6, 8, 10 (125, 203, 254)	26 (660)	47 (1194)	18 (457)	41 (1041)	7 (178)	6 x 18 (152 x 457)	9 1/8 x 10 1/2 (232 x 267)	6 x 18 (152 x 457)
5	10, 12, 14 (254, 305, 356)	26 (660)	53 (1346)	20 (508)	55 (1397)	7 (178)	12 x 20 (305 x 508)	13 1/8 x 15 5/8 (333 x 397)	12 x 20 (305 x 508)

Dimensions

Model Series 35SXC Stealth XC • Series Flow • Series Flow • Unit Sizes 1, 3, 5

Hot Water Coil Section

Model 35SWXC

Available in one, two or three row. Coil section installed on unit discharge. Right hand coil connection looking in direction of airflow standard (shown). Left hand is optional (terminals are inverted). Connections must be selected same hand as controls enclosure location.

Standard Features:

- Coil (and header on multi-circuit units) is installed in insulated casing for increased thermal efficiency.
- 1/2" (13) copper tubes.
- Aluminum fins.
- Sweat Connections:
Size 1: 1 Row 1/2" (13), 2 and 3 Row 7/8" (22); O.D. male solder.
Sizes 3 & 5: 1, 2, and 3 Row 7/8" (22); O.D. male solder.
- Top and bottom access panels for inspection and coil cleaning.
- Flanged outlet duct connection.

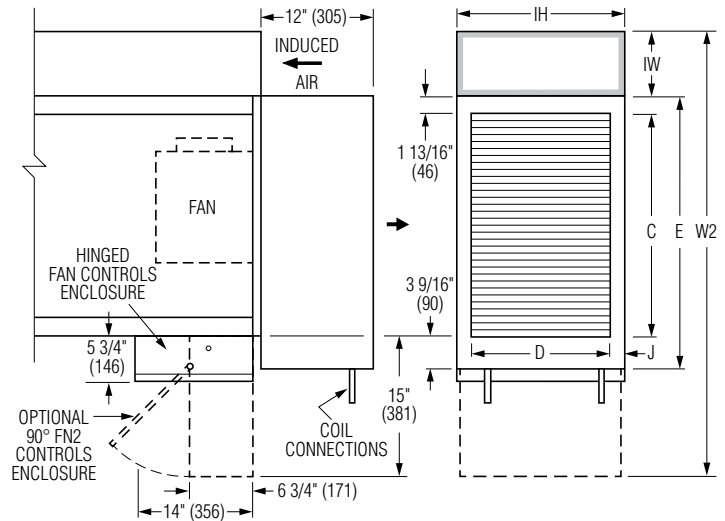

Unit Size	Outlet Duct Size C x D	W2	E	H	J
1	16 x 12 1/8 (406 x 308)	41 (1041)	21 3/8 (543)	14 (356)	1 (25)
3	16 x 14 7/8 (406 x 378)	47 (1194)	21 3/8 (543)	18 (457)	1 1/2 (38)
5	24 x 14 7/8 (610 x 378)	53 (1346)	29 3/8 (746)	20 (508)	1 1/2 (38)

Electric Coil Section

Model 35SEXC

Standard Features:

- Unique hinged heater design permits easy access, removal and replacement of heater element without disturbing ductwork.
- Coil installed on unit discharge.
- Insulated coil element wrapper.
- Automatic reset high limit cut-outs (one per element).
- Single point electrical connection (except 600V).
- Positive pressure airflow switch.
- Flanged outlet duct connection.
- Class A 80/20 Ni/Cr wire.
- Terminal unit with coil is ETL Listed as an assembly.
- Controls mounted as standard on RH side as shown.
Terminals ordered with LH controls (optional) are inverted and discharge duct hanging elevation will therefore change.

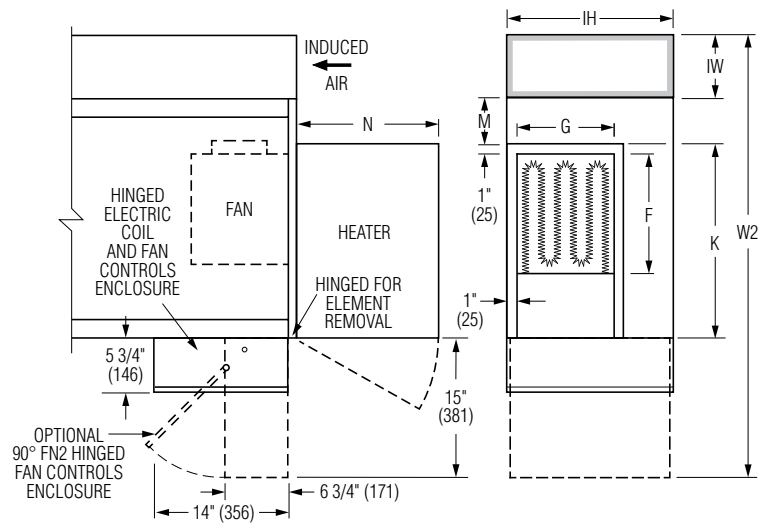

Unit Size	Outlet Duct Size F x G	W2	K	H	M	N
1	10 1/4 x 10 1/2 (260 x 267)	41 (1041)	16 (406)	14 (356)	4 (102)	12 1/2 (318)
3	12 1/4 x 10 3/4 (311 x 273)	47 (1194)	22 (559)	18 (457)	4 (102)	15 1/4 (387)
5	16 1/4 x 15 3/4 (413 x 400)	53 (1346)	22 (559)	20 (508)	4 (102)	15 1/4 (387)

Standard Supply Voltage (60 Hz):

- Single phase: 120, 208, 240 & 277V.
- Three phase: 208, 240 (3 wire) 480 (4 wire wye) and 600V (dual point connection).

Options:

- Toggle disconnect switch (Electric heat units require door interlock disconnect).
- Door interlock disconnect switch.
- Mercury contactors.
- Power circuit fusing.
- Dust tight construction.
- Manual reset secondary thermal cut out.
- SCR Control.

Performance Data

EPIC ECM Motor Fan Curves – Airflow vs. Downstream Static Pressure

Model Series 35SXC Stealth XC • Series Flow

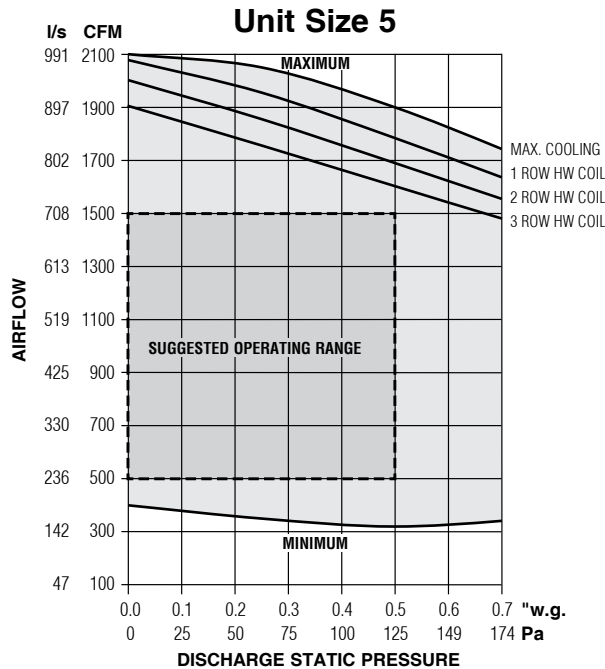
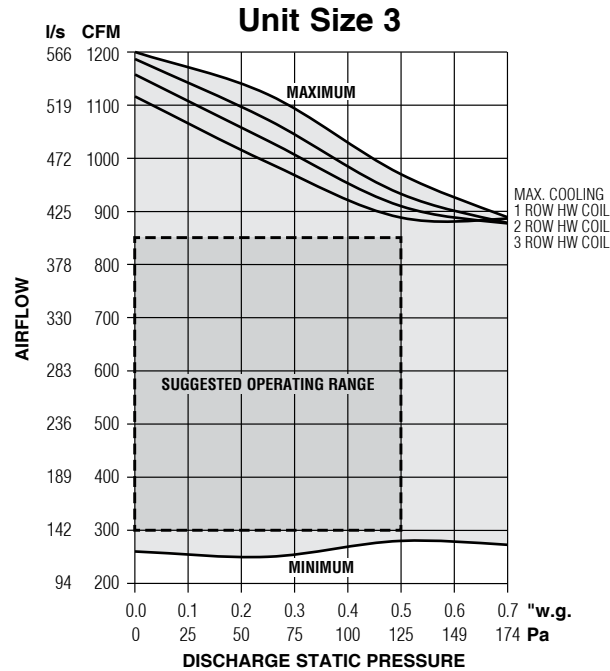
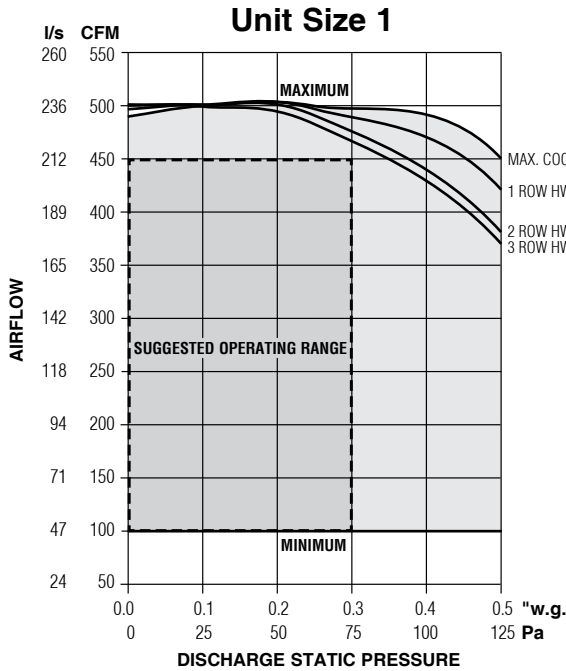

Electrical Data

Unit Size	EPIC ECM Motor FLA				
	Motor HP	120V	208V	240V	277V
1	*	2.1	1.4	1.3	1.2
3	*	4.8	3.4	3.1	3.0
5	*	10.5	6.8	6.4	6.2

* The EPIC ECM is a variable horsepower motor. Refer to Selectworks schedule for actual power consumption. FLA = Full load amperage. All motors are single phase/60 Hz.

NOTES:

- The EPIC ECM is a pressure independent constant volume device at set point and airflow does not vary with changing static pressure conditions. The motor compensates for any changes in static pressure such as filter loading.
- Airflow can be set to operate at any point within shaded area under the selected water coil curve using the EPIC volume controller card provided. Manual or Auto/Dynamic fan volume control can be selected on the EPIC card. The manual setting is for constant volume fan operation (adjustment is achieved using a pot. on the

card). Dynamic variable volume fan airflow adjustment is achieved by a DDC controller based on room demand using an analog 0-10 VDC input.

- Selections within the suggested operating range (dashed lines) will help ensure acceptable sound levels and optimized energy efficiency.
- Fan curves shown are applicable to 120/208/240 and 277 volt, single phase EPIC ECM (motors).



Performance Data • NC Level Application Guide

Model Series 35SXC Stealth XC • Series Flow

Steri-Liner

Unit Size	Inlet Size	Primary Airflow		Fan		Min. inlet ΔPs		NC Levels @ Inlet Pressure (ΔPs) shown							
								DISCHARGE NC PER 885 APPENDIX E				RADIATED NC NO CEILING			
								Fan Only	0.5 w.g. (125 Pa)	1.0" w.g. (250 Pa)	1.5" w.g. (375 Pa)	Fan Only	0.5" w.g. (125 Pa)	1.0" w.g. (250 Pa)	1.5" w.g. (375 Pa)
1	4	225	106	225	106	0.01	1.3	-	22	23	23	27	34	35	36
		200	95	200	95	0.00	1.1	-	20	20	20	26	33	34	35
		150	47	150	47	0.00	0.4	-	-	-	-	23	31	32	33
		100	47	100	47	0.00	0.4	-	-	-	-	20	28	30	30
		75	35	75	35	0.00	0.2	-	-	-	-	-	26	28	29
	5	400	189	400	189	0.005	1.3	24	33	33	33	33	37	38	39
		300	142	300	142	0.004	1.1	21	27	27	27	30	35	36	37
		200	95	200	95	0.003	0.7	-	-	-	-	26	32	33	34
		100	47	100	47	0.001	0.4	-	-	-	-	20	27	29	29
		75	35	75	35	0.001	0.2	-	-	-	-	-	25	27	28
	6	400	189	400	189	0.011	2.7	24	32	32	32	33	36	37	38
		300	142	300	142	0.008	1.9	21	26	26	26	30	34	35	36
		200	95	200	95	0.004	1.1	-	-	-	-	26	31	32	33
		100	47	100	47	0.001	0.4	-	-	-	-	20	26	28	28
		75	35	75	35	0.001	0.2	-	-	-	-	-	24	26	27
	8	400	189	400	189	0.011	2.7	24	29	29	30	33	33	35	36
		300	142	300	142	0.008	1.9	21	23	23	24	30	32	33	34
		200	95	200	95	0.004	1.1	-	-	-	-	26	29	30	31
		100	47	100	47	0.001	0.4	-	-	-	-	20	24	26	26
		75	35	75	35	0.001	0.2	-	-	-	-	18	22	24	24
3	6	550	260	550	260	0.02	3.8	29	28	28	28	38	38	40	41
		400	189	400	189	0.01	2.7	25	25	25	25	32	35	37	38
		300	165	300	165	0.01	1.5	21	22	22	22	28	33	35	36
		250	118	250	118	0.01	1.5	21	23	23	23	25	32	34	35
		200	95	200	95	0.00	1.1	22	25	25	25	21	30	32	33
	8	700	331	700	331	0.015	3.8	32	27	27	27	42	42	44	45
		650	307	650	307	0.011	2.7	34	29	29	29	41	41	43	44
		500	236	500	236	0.008	1.9	30	27	27	27	36	39	41	42
		350	165	350	165	0.006	1.5	26	24	24	24	30	36	38	39
		200	95	200	95	0.004	1.1	22	23	23	23	21	32	34	35
	10	1100	520	1100	520	0.026	6.6	41	31	31	31	51	39	41	42
		950	449	950	449	0.024	5.9	39	30	30	30	48	38	40	41
		700	331	700	331	0.019	4.7	35	27	27	27	42	36	38	39
		450	213	450	213	0.012	3.1	33	27	27	27	34	32	34	35
		200	95	200	95	0.004	1.1	22	20	20	20	21	26	28	29
5	10	1100	520	1100	520	0.03	6.6	31	31	31	31	44	42	44	45
		900	425	900	425	0.02	5.7	30	28	28	28	39	40	42	43
		700	331	700	331	0.02	4.1	30	24	24	24	33	38	39	40
		600	284	600	284	0.02	4.1	31	21	21	22	30	36	38	38
		500	236	500	236	0.01	3.4	33	-	-	-	27	34	36	37
	12	1800	851	1800	851	0.026	6.6	35	37	37	37	55	48	49	50
		1300	615	1300	615	0.023	5.7	32	31	32	32	47	43	44	45
		1000	473	1000	473	0.019	4.7	30	27	27	28	42	39	41	42
		700	331	700	331	0.016	4.1	30	21	22	22	33	36	37	38
		500	236	500	236	0.014	3.4	33	-	-	-	27	32	34	35
	14	2050	969	2050	969	0.036	9.0	36	36	37	37	58	47	49	50
		1600	756	1600	756	0.032	8.1	34	32	33	33	52	43	45	46
		1350	638	1350	638	0.030	7.4	33	30	30	30	48	41	42	43
		900	425	900	425	0.023	5.7	30	23	23	23	39	36	38	39
		500	236	500	236	0.014	3.4	33	-	-	-	27	30	32	33

Performance Notes:

1. Discharge NC Levels are calculated based on procedures as outlined on page C160 (Specific application data requires acoustical evaluation - contact factory). Radiated NC sound is based on mock-up tests conducted in the Energetics Laboratory.
2. Dash (-) in space indicates a NC less than 20.

FAN POWERED TERMINAL UNITS

Performance Data • Discharge Sound Power Levels

Model Series 35SXC Stealth XC • Series Flow

Steri-Liner



Unit Size	Inlet Size	Primary Airflow		Fan		Min. inlet ΔPs		Fan Only		Fan and 100% Primary Air – Sound Power Octave Bands @ Inlet pressure (ΔPs) shown																					
										0.5" w.g. (125Pa) ΔPs							1.0" w.g. (249Pa) ΔPs							1.5" w.g. (375Pa) ΔPs							
										cfm	l/s	cfm	l/s	"w.g.	Pa	2	3	4	5	6	7	2	3	4	5	6	7	2	3	4	5
1	4	225	106	225	106	0.005	1.3	63	56	53	53	48	44	66	58	52	52	46	41	66	58	51	51	46	41	66	58	51	51	46	41
		200	95	200	95	0.004	1.1	63	55	52	51	46	41	64	55	49	50	44	38	64	55	49	49	44	38	65	55	48	49	44	38
		150	71	150	71	0.003	0.7	60	52	49	47	41	36	59	50	43	44	37	30	60	50	43	43	37	30	60	50	43	43	37	30
		100	47	100	47	0.001	0.4	57	47	44	40	34	28	53	42	35	35	27	19	53	42	35	35	27	19	53	42	34	34	27	19
		75	35	75	35	0.001	0.2	55	43	40	36	29	22	48	36	29	29	21	11	48	36	29	29	21	11	49	36	28	28	21	11
	5	400	189	400	189	0.011	2.7	68	63	60	62	58	55	74	68	62	63	59	56	75	68	62	62	59	56	75	68	62	62	59	56
		300	142	300	142	0.008	1.9	65	60	57	57	53	49	70	62	57	57	52	48	70	62	56	56	52	48	70	62	56	56	52	48
		200	95	200	95	0.004	1.1	63	55	52	51	46	41	63	54	48	49	43	37	63	54	48	48	43	37	64	54	47	48	43	37
		100	47	100	47	0.001	0.4	57	47	44	40	34	28	52	41	34	34	26	18	52	41	34	34	26	18	52	41	33	33	26	18
		75	35	75	35	0.001	0.2	55	43	40	36	29	22	47	35	28	28	20	10	47	35	28	28	20	10	47	35	27	27	20	10
	6	400	189	400	189	0.011	2.7	68	63	60	62	58	55	73	67	61	62	58	55	74	67	61	61	58	55	74	67	61	61	58	55
		300	142	300	142	0.008	1.9	65	60	57	57	53	49	69	61	56	56	51	47	69	61	55	55	51	47	69	61	55	55	51	47
		200	95	200	95	0.004	1.1	63	55	52	51	46	41	62	53	47	48	42	36	62	53	47	47	42	36	63	53	46	47	42	36
		100	47	100	47	0.001	0.4	57	47	44	40	34	28	51	40	33	33	25	17	51	40	33	33	25	17	51	40	32	32	25	17
		75	35	75	35	0.001	0.2	55	43	40	36	29	22	46	34	27	27	19	9	46	34	27	27	19	9	47	34	26	26	19	9
	8	400	189	400	189	0.011	2.7	68	63	60	62	58	55	71	65	59	60	56	53	72	65	59	59	56	53	72	65	59	59	56	53
		300	142	300	142	0.008	1.9	65	60	57	57	53	49	67	59	54	54	49	45	67	59	53	53	49	45	70	62	56	53	49	45
		200	95	200	95	0.004	1.1	63	55	52	51	46	41	60	51	45	46	40	34	60	51	45	45	40	34	61	51	44	45	40	34
		100	47	100	47	0.001	0.4	57	47	44	40	34	28	49	38	31	31	23	15	49	38	31	31	23	15	49	38	30	30	23	15
		75	35	75	35	0.001	0.2	55	43	40	36	29	22	44	32	25	25	17	7	44	32	25	25	17	7	45	32	24	24	17	7
3	6	550	260	550	260	0.015	3.8	76	67	64	63	58	55	75	67	65	61	58	55	75	68	65	61	58	56	75	68	66	61	58	56
		400	189	400	189	0.011	2.7	73	64	60	58	54	50	73	64	62	58	54	51	73	65	62	58	54	51	73	65	62	58	54	51
		300	142	300	142	0.008	1.9	70	61	57	54	50	45	71	62	59	54	51	46	71	62	59	55	51	47	71	63	59	55	51	47
		250	118	250	118	0.006	1.5	68	59	55	51	47	42	70	60	57	52	48	44	70	61	57	52	49	44	70	61	57	53	49	44
		200	95	200	95	0.004	1.1	66	56	52	48	44	38	68	58	54	50	46	40	68	59	55	50	46	41	68	59	55	50	46	41
	8	700	331	700	331	0.019	4.7	79	70	67	66	62	59	75	67	66	62	59	57	75	68	66	62	59	57	75	68	66	62	59	58
		650	307	650	307	0.018	4.4	78	69	66	65	61	58	74	67	65	61	58	56	74	67	65	61	58	56	74	68	65	61	58	56
		500	236	500	236	0.014	3.4	75	66	63	61	57	54	73	64	62	58	55	52	73	65	62	58	55	52	73	65	63	58	55	53
		350	165	350	165	0.009	2.3	72	62	59	56	52	48	70	61	58	54	50	47	70	62	59	54	51	47	70	62	59	54	51	47
		200	95	200	95	0.004	1.1	66	56	52	48	44	38	66	56	52	48	44	38	66	57	53	48	44	39	66	57	53	48	44	39
	10	1100	520	1100	520	0.026	6.5	84	75	72	73	68	67	76	69	69	65	62	62	76	70	69	65	62	62	76	70	69	65	62	62
		950	449	950	449	0.024	5.9	82	73	71	71	66	65	75	68	67	63	60	60	75	69	67	63	60	60	75	69	67	63	61	60
		700	331	700	331	0.019	4.7	79	70	67	66	62	59	73	65	64	60	57	55	73	66	64	60	57	55	73	66	64	60	57	56
		450	213	450	213	0.012	3.1	74	65	62	60	56	52	70	61	59	55	51	48	70	62	59	55	52	49	70	63	59	55	52	49
		200	95	200	95	0.004	1.1	66	56	52	48	44	38	64	54	50	46	42	36	64	55	51	46	42	37	64	55	51	46	42	37
5	10	1100	520	1100	520	0.026	6.5	76	73	71	71	67	66	76	73	71	70	66	65	77	73	72	70	69	66	77	73	72	71	70	67
		900	425	900	425	0.023	5.7	75	72	70	69	66	64	74	70	69	67	63	62	74	70	69	67	65	63	74	70	69	68	67	63
		700	331	700	331	0.019	4.7	73	70	68	67	64	62	70	66	66	63	59	58	70	67	66	63	61	59	71	67	66	64	63	59
		600	284	600	284	0.016	4.1	72	69	67	66	63	60	68	64	64	61	56	55	68	65	64	61	58	56	69	65	64	61	60	57
		500	236	500	236	0.014	3.4	71	68	66	65	61	59	65	62	62	58	53	52	66	62	62	58	55	53	66	62	62	59	57	54
	12	1800	851	1800	851	0.034	8.5	79	76	74	75	71	70	81	77	75	75	73	72	82	78	76	76	75	72	82	78	76	76	77	73
		1300	615	1300	615	0.029	7.2	77	74	72	72	69	67	77	73	71	70	67	66	77	73	72	71	70	67	77	73	72	71	71	67
		1000	473	1000	473	0.025	6.1	75	72	70	70	67	65	73	69	68	66	63	62	74	70	68	67	65	63	74	70	68	67	67	63
		700	331	700	331	0.019	4.7	73	70	68	67	64	62	68	64	64	61	57	56	68	65	64	61	59	57	69	65	64	62	61	57
		500	236	500	236	0.014	3.4	71	68	66	65	61	59	63	60	60	56	51	50	64	60	60	56	53	51	64	60	60	57	55	52
	14	2050	969	2050	969	0.036	9.0	79	77	74	76	72	71	81	77	75	75	73	72	82	77	75	76	76	73	82	78	75	76	77	73
		1600	756	1600	756	0.032	8.1	78	75	73	74	70	69	78	74	72	72	69	68	78	74	72	72	71	68	78	74	72	72	73	69
		1350	638	1350	638	0.030	7.4	77	74	72	72	69	67	75	71	70	69	66	65	76	72	70	69	68	66	76	72	70	70	70	66
		900	425	900	425	0.023	5.7	75	72	70	69	66	64	70	66	65	63	59	58	70	66	65	63	61	59	70	66	65	64	63	59
		500	236	500	236	0.014	3.4	71	68	66	65	61	59	61	58	58	54	49	48	62	58	58	54	51	49	62	58	58	55	53	50

For performance table notes, see page C104; highlighted numbers indicate embedded AHRI certification points.

Performance Data • Radiated Sound Power Levels

Model Series 35SXC Stealth XC • Series Flow

Steri-Liner



Unit Size	Inlet Size	Primary Airflow		Fan		Min. inlet ΔPs		Fan Only							Fan and 100% Primary Air—Sound Power Octave Bands @ Inlet pressure (ΔPs) shown																				
															0.5" w.g. (125Pa) ΔPs							1.0" w.g. (249Pa) ΔPs							1.5" w.g. (375Pa) ΔPs						
								cfm	l/s	cfm	l/s	"w.g.	Pa	2	3	4	5	6	7	2	3	4	5	6	7	2	3	4	5	6	7	2	3	4	5
1	4	225	106	225	106	0.005	1.3	51	45	38	32	27	24	55	51	44	39	34	34	56	52	45	41	35	36	57	52	46	41	36	37				
		200	95	200	95	0.004	1.1	50	44	37	31	25	23	55	50	43	39	33	33	56	51	44	40	35	35	56	51	45	41	35	36				
		150	71	150	71	0.003	0.7	49	42	35	28	21	20	53	48	41	37	32	31	54	48	42	38	33	33	54	49	43	39	34	35				
		100	47	100	47	0.001	0.4	47	39	32	23	16	16	51	44	38	34	29	29	51	45	39	35	30	31	52	46	39	36	31	32				
		75	35	75	35	0.001	0.2	45	37	30	20	13	13	49	42	36	32	27	27	50	43	37	33	28	29	50	44	37	34	29	31				
	5	400	189	400	189	0.011	2.7	54	49	43	38	34	30	58	54	47	42	37	36	59	55	48	43	38	38	59	55	49	44	39	39				
		300	142	300	142	0.008	1.9	52	47	40	35	30	27	56	52	45	40	35	34	57	53	46	41	36	36	57	53	47	42	37	38				
		200	95	200	95	0.004	1.1	50	44	37	31	25	23	54	49	42	38	32	32	55	50	43	39	34	34	55	50	44	40	34	35				
		100	47	100	47	0.001	0.4	47	39	32	23	16	16	50	43	37	33	28	28	50	44	38	34	29	30	51	45	38	35	30	31				
		75	35	75	35	0.001	0.2	45	37	30	20	13	13	48	41	35	31	26	26	49	42	36	32	27	28	49	43	36	33	28	30				
	6	400	189	400	189	0.011	2.7	54	49	43	38	34	30	57	53	46	41	36	35	58	54	47	42	37	37	58	54	48	43	38	38				
		300	142	300	142	0.008	1.9	52	47	40	35	30	27	55	51	44	39	34	33	56	52	45	40	35	35	56	52	46	41	36	37				
		200	95	200	95	0.004	1.1	50	44	37	31	25	23	53	48	41	37	31	31	54	49	42	38	33	33	54	49	43	39	33	34				
		100	47	100	47	0.001	0.4	47	39	32	23	16	16	49	42	36	32	27	27	49	43	37	33	28	29	50	44	37	34	29	30				
		75	35	75	35	0.001	0.2	45	37	30	20	13	13	47	40	34	30	25	25	48	41	35	31	26	27	48	42	35	32	27	29				
	8	400	189	400	189	0.011	2.7	54	49	43	38	34	30	55	51	44	39	34	33	56	52	45	40	35	35	56	52	46	41	36	36				
		300	142	300	142	0.008	1.9	52	47	40	35	30	27	53	49	42	37	32	31	54	50	43	38	33	33	54	50	44	39	34	35				
		200	95	200	95	0.004	1.1	50	44	37	31	25	23	51	46	39	35	29	29	52	47	40	36	31	31	52	47	41	37	31	32				
		100	47	100	47	0.001	0.4	47	39	32	23	16	16	47	40	34	30	25	25	47	41	35	31	26	27	48	42	35	32	27	28				
		75	35	75	35	0.001	0.2	45	37	30	20	13	13	45	38	32	28	23	23	46	39	33	29	24	25	46	40	33	30	25	27				
3	6	550	260	550	260	0.015	3.8	60	53	46	41	37	33	61	55	48	41	38	36	62	56	49	42	40	39	63	57	50	43	41	41				
		400	189	400	189	0.011	2.7	56	49	42	36	31	26	58	52	45	38	35	34	59	53	46	39	37	37	60	54	47	40	38	38				
		300	142	300	142	0.008	1.9	53	46	39	31	25	20	56	49	42	35	33	32	57	50	43	37	35	34	57	51	44	37	36	36				
		250	118	250	118	0.006	1.5	52	44	37	28	21	16	54	47	40	34	32	30	55	48	41	35	34	33	56	49	42	36	35	34				
		200	95	200	95	0.004	1.1	49	41	34	25	17	11	52	45	38	32	30	28	53	46	39	33	32	31	54	47	40	34	33	33				
	8	700	331	700	331	0.019	4.7	62	56	49	45	42	38	65	59	52	45	42	40	66	60	53	46	44	43	67	61	54	47	45	45				
		650	307	650	307	0.018	4.4	61	55	48	44	41	37	64	58	51	44	41	40	65	60	53	45	43	42	66	60	53	46	44	44				
		500	236	500	236	0.014	3.4	59	52	45	39	35	31	62	56	49	42	39	38	63	57	50	43	41	40	64	58	51	44	42	42				
		350	165	350	165	0.009	2.3	55	48	41	34	28	23	59	52	45	39	36	35	60	54	47	40	38	37	61	54	47	41	39	39				
		200	95	200	95	0.004	1.1	49	41	34	25	17	11	54	47	40	34	32	30	55	48	41	35	34	33	56	49	42	36	35	35				
	10	1100	520	1100	520	0.026	6.5	67	62	54	52	51	48	63	57	50	43	39	38	64	59	52	44	41	41	65	59	52	45	42	42				
		950	449	950	449	0.024	5.9	65	60	53	50	48	45	62	56	49	42	38	37	63	57	50	43	40	39	64	58	51	44	41	41				
		700	331	700	331	0.019	4.7	62	56	49	45	42	38	59	53	46	39	36	34	60	54	47	40	38	37	61	55	48	41	39	39				
		450	213	450	213	0.012	3.1	58	51	44	38	33	29	55	49	42	35	32	31	56	50	43	36	34	33	57	51	44	37	35	35				
		200	95	200	95	0.004	1.1	49	41	34	25	17	11	48	41	34	28	26	24	49	42	35	29	28	27	50	43	36	30	29	29				
5	10	1100	520	1100	520	0.026	6.5	67	59	50	45	44	41	69	62	53	45	42	44	70	63	55	46	44	44	70	64	55	47	45	44				
		900	425	900	425	0.023	5.7	64	56	47	41	39	36	66	59	51	42	40	42	67	60	52	44	42	42	68	61	53	44	43	42				
		700	331	700	331	0.019	4.7	61	53	44	37	33	30	63	56	48	40	38	40	64	57	49	41	39	40	64	57	50	42	40	40				
		600	284	600	284	0.016	4.1	59	51	42	34	30	26	61	54	46	38	36	38	62	55	47	39	38	38	62	55	48	40	38	39				
		500	236	500	236	0.014	3.4	57	49	40	30	26	22	58	51	44	36	34	36	59	52	45	37	36	37	60	53	46	38	37	37				
	12	1800	851	1800	851	0.034	8.5	73	65	57	54	55	53	73	66	57	48	46	46	74	68	59	49	47	47	75	68	59	50	48	47				
		1300	615	1300	615	0.029	7.2	69	61	52	48	47	45	69	62	53	44	42	43	70	63	55	46	44	44	71	64	55	46	45	44				
		1000	473	1000	473	0.025	6.1	66	58	49	43	42	39	66	58	50	41	39	41	67	60	51	43	41	41	67	60	52	43	42	41				
		700	331	700	331	0.019	4.7	61	53	44	37	33	30	61	54	46	38	36	38	62	55	47	39	37	38	62	55	48	40	38	38				
		500	236	500	236	0.014	3.4	57	49	40	30	26	22	56	49	42	34	32	34	57	50	43	35	34	35	58	51	44	36	35	35				
	14	2050	969	2050	969	0.036	9.0	74	67	58	57	58	57	73	66	57	47	45	46	74	67	58	49	46	46	75	68	59	49	47	46				
		1600	756	1600	756	0.032	8.1	71	64	55	52	52	50	70	63	54	45	42	43	71	64	55	46	44	44	71	65	56	47	45	44				
		1350	638	1350	638	0.030	7.4	69	61	53	49	48	46	68	61	52	43	41	42	69	62	53	44	42	42	69	62	54	45	43	42				
		900	425	900	425	0.023	5.7	64	56	47	41	39	36	62	55	47	38	36	38	63	56	48	40	38	38	64	57	49	40	39	38				
		500	236	500	236	0.014	3.4	57	49	40	30	26	22	54	47	40	32	30	32	55	48	41	33	32	33	56	49	42	34	33	33				

FAN POWERED TERMINAL UNITS

For performance table notes, see page C104; highlighted numbers indicate embedded AHRI certification points.

Performance Data • AHRI Certification and Performance Notes

Model Series 35SXC Stealth XC • Series Flow • AHRI Certification Rating Points

Steri-Liner

Unit Size	Inlet Size	Fan Airflow		Fan Σ Watts	Fan Only* @ .25" w.g. (62 Pa) Δ Ps														Primary Airflow	Min. Inlet Δ Ps	Fan + 100% Primary @ 1.5" w.g. (375 Pa) Δ Ps w/ .25" w.g. (62 Pa) Discharge Δ Ps						
					Discharge							Radiated									Radiated						
					2	3	4	5	6	7	2	3	4	5	6	7	cfm	l/s			"w.g.	Pa	2	3	4	5	6
1	6	400	189	165	68	63	60	62	58	55	54	49	43	38	34	30	400	189	0.011	2.7	58	54	48	43	38	38	
3	8	700	331	400	79	70	67	66	62	59	62	56	49	45	42	38	700	331	0.019	4.7	67	61	54	47	45	45	
5	10	1100	520	680	76	73	71	71	67	66	67	59	50	45	44	41	1100	520	0.026	6.5	70	64	55	47	45	44	

Σ Motor = ECM.

* Primary air valve is closed and therefore primary cfm is zero.



Ratings are certified in accordance with AHRI Standards.

Performance Notes for Sound Power Levels:

- Discharge (external) static pressure is 0.25" w.g. (63 Pa) in all cases, which is the difference (Δ Ps) in static pressure from terminal discharge to the room.
Discharge Sound Power Levels (SWL) include duct end reflection energy as part of the standard rating. Including the duct end correction provides sound power levels that would normally be transmitted into an acoustically, non-reflective duct. The effect of including the energy correction to the discharge SWL, is higher sound power levels when compared to previous AHRI certified data. For more information on duct end reflection calculations see AHRI Standard 880.
- Radiated sound power is the breakout noise transmitted through the unit casing walls and induction port.
- Sound power levels are in decibels, dB re 10^{-12} watts.
- All sound data listed by octave bands is raw data without any corrections for room absorption or duct attenuation. Dash (-) in space indicates sound power level is less than 20 dB or equal to background.
- Min. inlet Δ Ps is the minimum operating pressure of the primary air valve section.
- Asterisk (*) in space indicates that the minimum inlet static pressure requirement is greater than 0.5" w.g. (125 Pa) at rated airflow.
- Data derived from independent tests conducted in accordance with ANSI / ASHRAE Standard 130 and AHRI Standard 880.

Performance Data • Hot Water Coil

Model: 35SWXC • Series Flow

Unit Size 1

1 Row (single circuit)

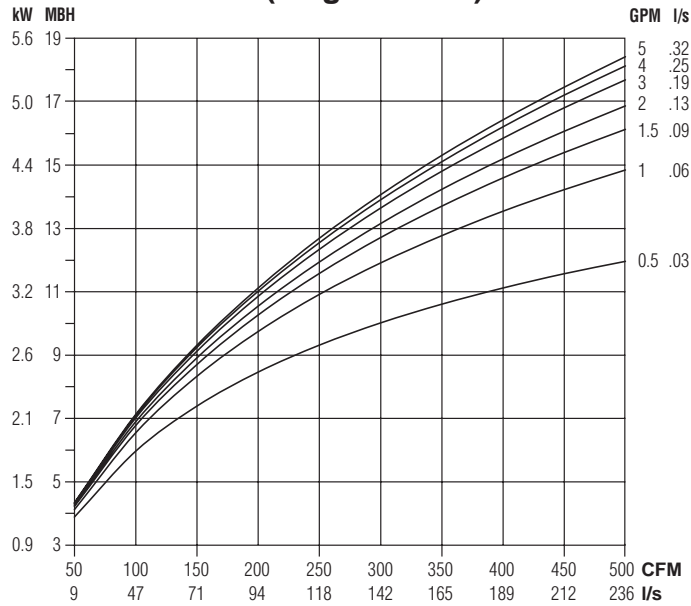

2 Row (multi-circuit)

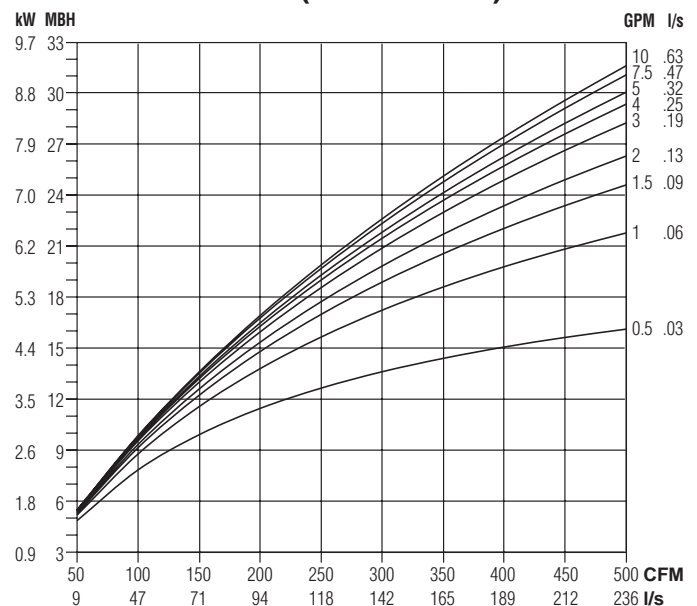

3 Row (multi-circuit)

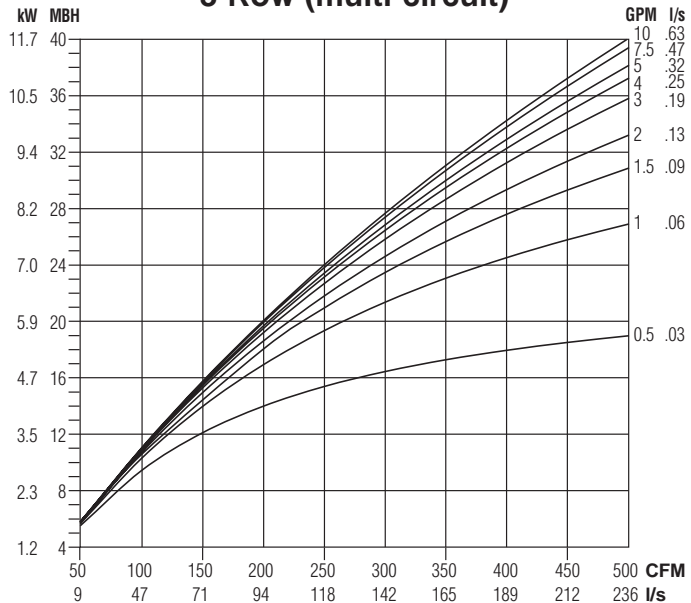

Water Pressure Drop

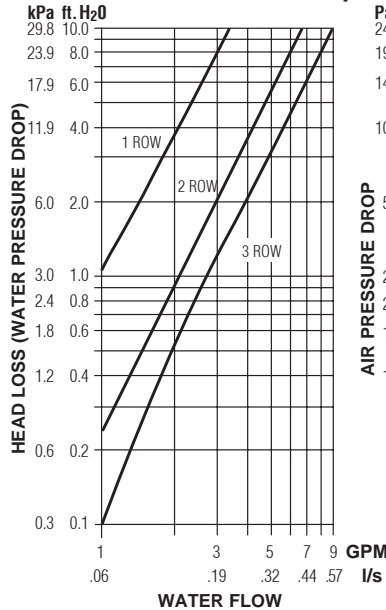

Air Pressure Drop

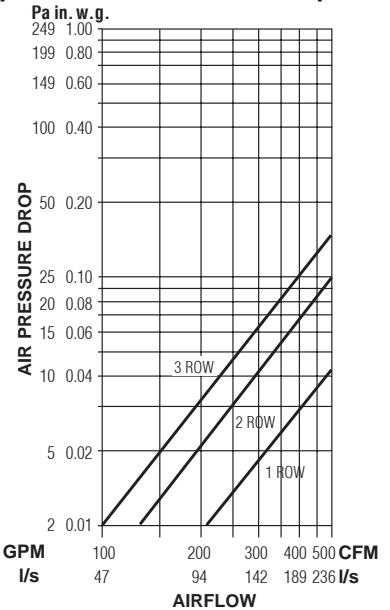

NOTES:

- Capacities are in MBH (kW), **thousands of Btu per hour (kiloWatts)**.
- MBH (kW) values are based on a Δt (temperature difference) of 110°F (61°C) between entering air and entering water. For other Δt 's; multiply the MBH (kW) values by the factors below.

- Air Temperature Rise.

$$\text{ATR (°F)} = 927 \times \frac{\text{MBH}}{\text{cfm}}, \quad \text{ATR (°C)} = 829 \times \frac{\text{kW}}{\text{l/s}}$$

- Water Temp. Drop.

$$\text{WTD (°F)} = 2.04 \times \frac{\text{MBH}}{\text{GPM}}, \quad \text{WTD (°C)} = .224 \times \frac{\text{kW}}{\text{l/s}}$$

- Connections: 1 Row 1/2" (13), 2 and 3 Row 7/8" (22); O.D. male solder.

Altitude Correction Factors:

Altitude ft. (m)	Sensible Heat Factor
0 (0)	1.00
2000 (610)	0.94
3000 (914)	0.90
4000 (1219)	0.87
5000 (1524)	0.84
6000 (1829)	0.81
7000 (2134)	0.78

Correction factors at other entering conditions:

Δt °F (°C)	50 (28)	60 (33)	70 (39)	80 (44)	90 (50)	100 (56)	110 (61)	120 (67)	130 (72)	140 (78)	150 (83)
Factor	.455 (.459)	.545 (.541)	.636 (.639)	.727 (.721)	.818 (.820)	.909 (.918)	1.00 (1.00)	1.09 (1.10)	1.18 (1.18)	1.27 (1.28)	1.36 (1.36)

Performance Data • Hot Water Coil

Model: 35SWXC • Series Flow

Unit Size 3

1 Row (single circuit)

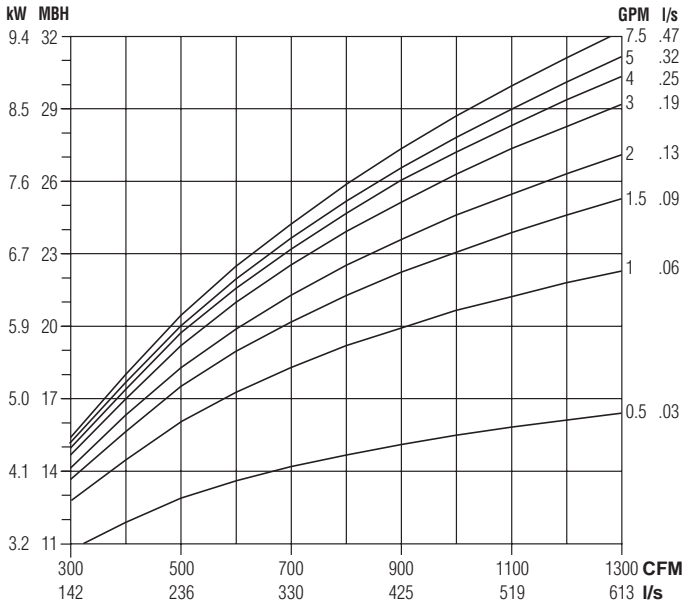

2 Row (multi-circuit)

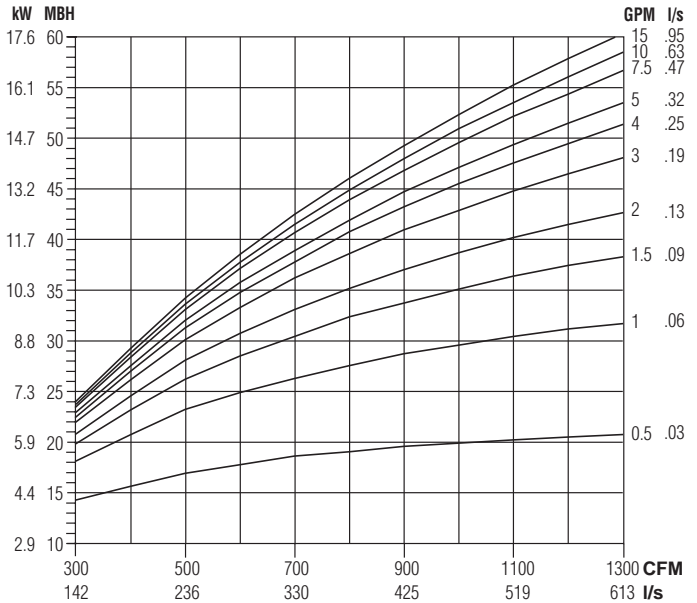

3 Row (multi-circuit)

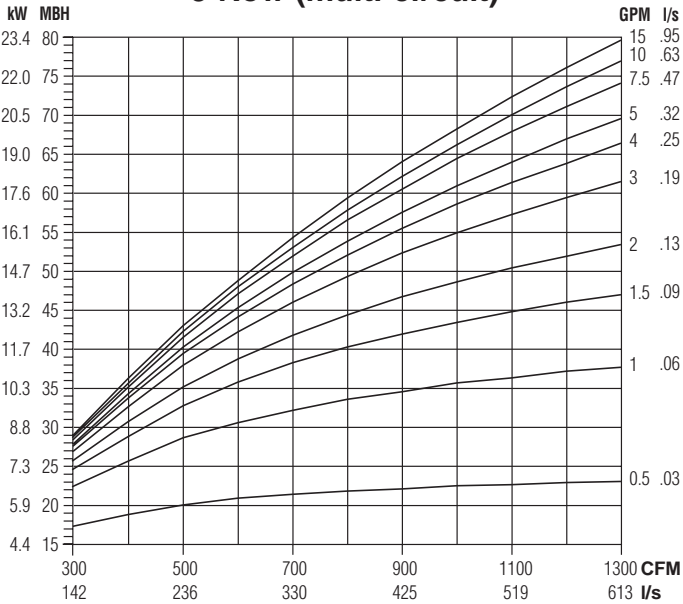

Water Pressure Drop

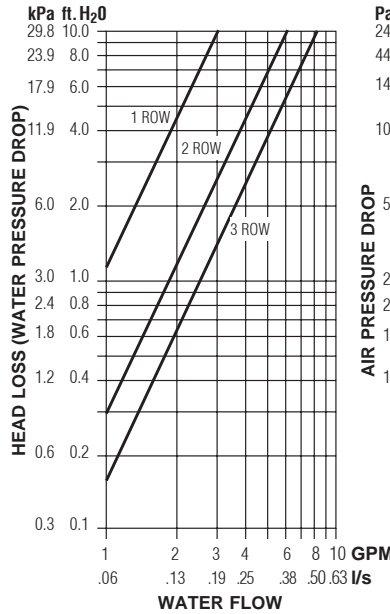

Air Pressure Drop

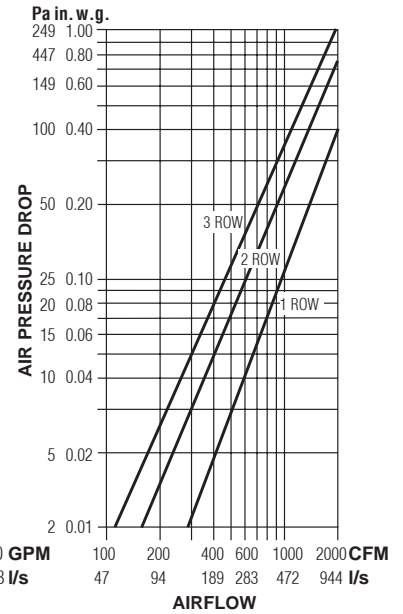

NOTES:

- Capacities are in MBH (kW), **thousands of Btu per hour (kiloWatts)**.
- MBH (kW) values are based on a Δt (temperature difference) of 110°F (61°C) between entering air and entering water. For other Δt 's; multiply the MBH (kW) values by the factors below.
- Air Temperature Rise.
 $ATR (^{\circ}F) = 927 \times \frac{MBH}{cfm}$, $ATR (^{\circ}C) = 829 \times \frac{kW}{l/s}$
- Water Temp. Drop.
 $WTD (^{\circ}F) = 2.04 \times \frac{MBH}{GPM}$, $WTD (^{\circ}C) = .224 \times \frac{kW}{l/s}$
- Connections: 1 Row 1/2" (13), 2 and 3 Row 7/8" (22); O.D. male solder.

Altitude Correction Factors:

Altitude ft. (m)	Sensible Heat Factor
0 (0)	1.00
2000 (610)	0.94
3000 (914)	0.90
4000 (1219)	0.87
5000 (1524)	0.84
6000 (1829)	0.81
7000 (2134)	0.78

Correction factors at other entering conditions:

Δt °F (°C)	50 (28)	60 (33)	70 (39)	80 (44)	90 (50)	100 (56)	110 (61)	120 (67)	130 (72)	140 (78)	150 (83)
Factor	.455 (.459)	.545 (.541)	.636 (.639)	.727 (.721)	.818 (.820)	.909 (.918)	1.00 (1.00)	1.09 (1.10)	1.18 (1.18)	1.27 (1.28)	1.36 (1.36)

Performance Data • Hot Water Coil

Model: 35SWXC • Series Flow

Unit Size 5

1 Row (multi-circuit)

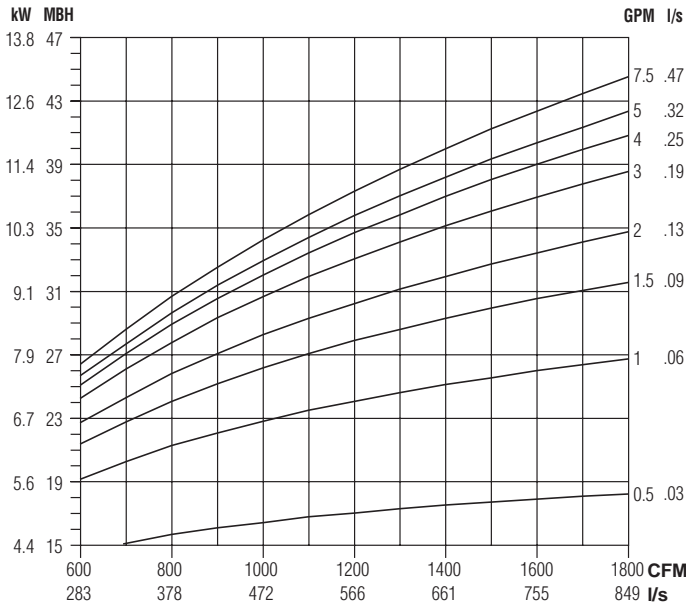

2 Row (multi-circuit)

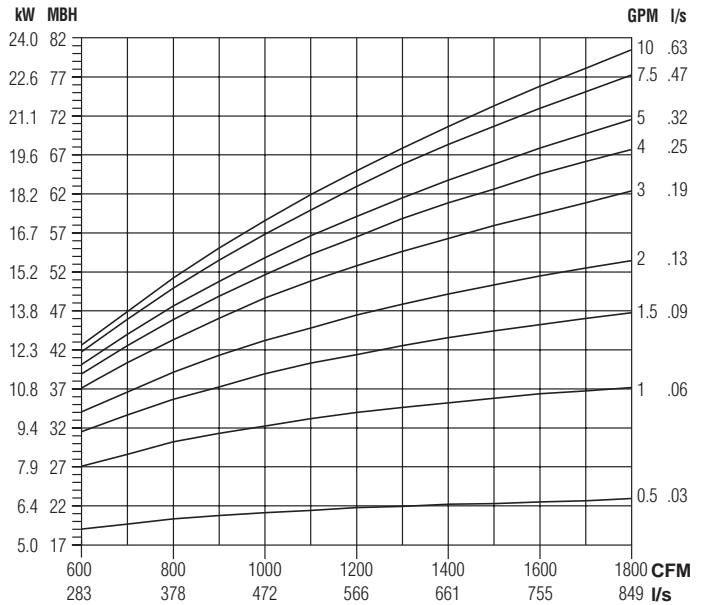

3 Row (multi-circuit)

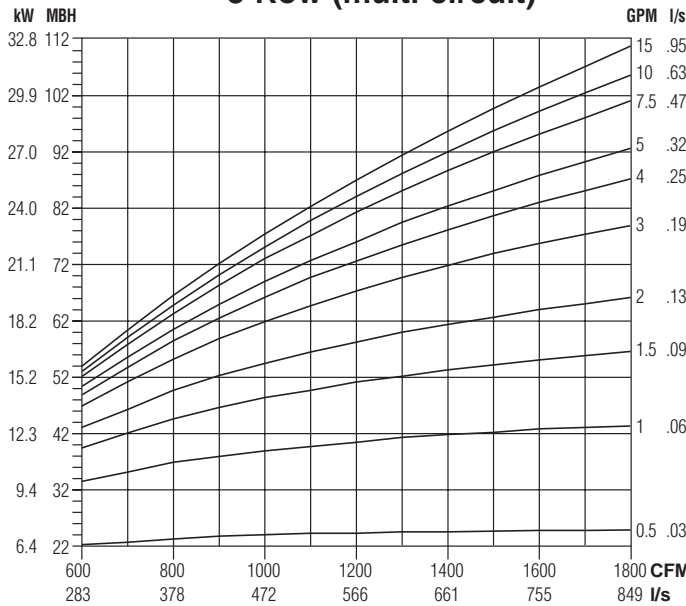

Water Pressure Drop

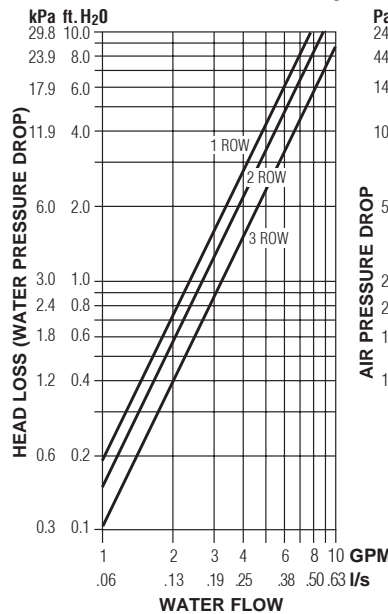

Air Pressure Drop

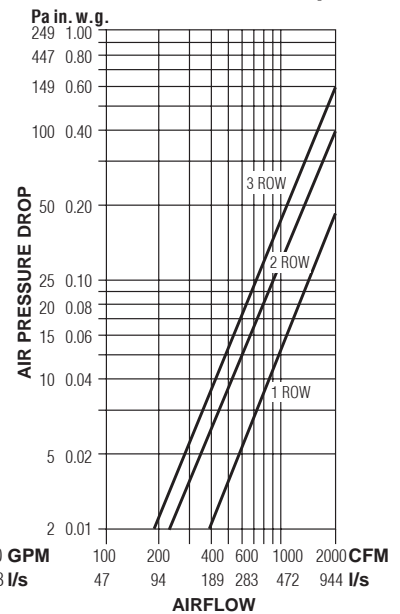

NOTES:

- Capacities are in MBH (kW), *thousands of Btu per hour (kiloWatts)*.
- MBH (kW) values are based on a Δt (temperature difference) of 110°F (61°C) between entering air and entering water. For other Δt 's; multiply the MBH (kW) values by the factors below.

- Air Temperature Rise.

$$\text{ATR (}^\circ\text{F)} = 927 \times \frac{\text{MBH}}{\text{cfm}}, \quad \text{ATR (}^\circ\text{C)} = 829 \times \frac{\text{kW}}{\text{l/s}}$$

- Water Temp. Drop.

$$\text{WTD (}^\circ\text{F)} = 2.04 \times \frac{\text{MBH}}{\text{GPM}}, \quad \text{WTD (}^\circ\text{C)} = .224 \times \frac{\text{kW}}{\text{l/s}}$$

- Connections: 1, 2 and 3 Row 7/8" (22); O.D. male solder.

Altitude Correction Factors:

Altitude ft. (m)	Sensible Heat Factor
0 (0)	1.00
2000 (610)	0.94
3000 (914)	0.90
4000 (1219)	0.87
5000 (1524)	0.84
6000 (1829)	0.81
7000 (2134)	0.78

Correction factors at other entering conditions:

Δt °F (°C)	50 (28)	60 (33)	70 (39)	80 (44)	90 (50)	100 (56)	110 (61)	120 (67)	130 (72)	140 (78)	150 (83)
Factor	.455 (.459)	.545 (.541)	.636 (.639)	.727 (.721)	.818 (.820)	.909 (.918)	1.00 (1.00)	1.09 (1.10)	1.18 (1.18)	1.27 (1.28)	1.36 (1.36)

**SERIES FLOW
CONSTANT OR
VARIABLE VOLUME**

37S SERIES

• **LOW PROFILE**

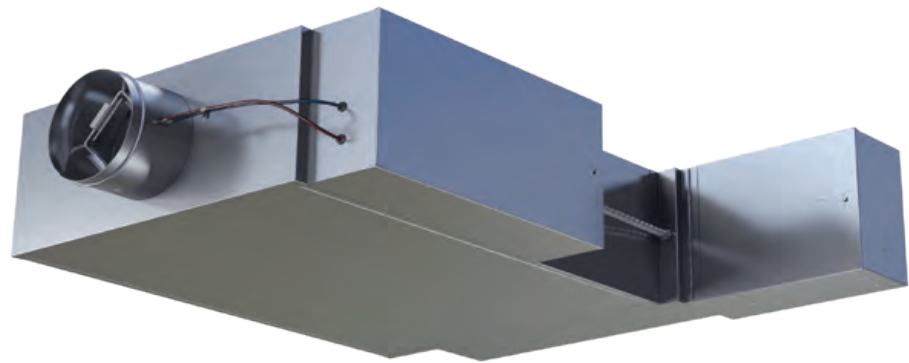

Model 37SE

Models:

- 37S** **No Heat**
- 37SE** **Electric Heat**
- 37SW** **Hot Water Heat**

The **37S Series** Low Profile terminals are designed for shallow ceiling plenum applications and therefore limited to 11" (279) in height. Shallow plenums are common where zoning requirements limit building height. When building height is constrained, building designers will maximize the number of floors by reducing the distance between floors, requiring low profile products like the 37S Series.

STANDARD FEATURES:

- 20 ga. (1.0) galvanized steel construction.
- 16 ga. (1.61) galvanized steel inclined opposed blade primary air damper. 45° rotation, CW to close. 1/2" (13) dia. plated steel drive shaft. An indicator mark on the end of the shaft shows damper-position. Leakage is less than 2% of nominal flow at 3" w.g. (750 Pa).
- Perforated baffle on primary air discharge optimizes mixing with induced air for rapid and effective temperature equalization. The baffle also converts low frequency primary air valve generated sound into more readily attenuated higher frequencies.
- Pressure independent primary airflow control.
- Multi-point averaging Diamond flow sensor.
- Terminal is field flippable, providing left or right installation connections. Refer to IOM for details.
- Access panels are full size on top and bottom of terminal for ease of maintenance and service.
- Energy efficient PSC fan motor with thermal overload protection.
- Motor blower assembly mounted on special 16 ga. (1.61) angles and isolated from casing with rubber isolators.

- Adjustable PSC solid state fan speed controller with minimum voltage stop.
- Hinged door on fan controls enclosure.
- 1/2" (13), dual density insulation. Exposed edges coated to prevent air erosion. Meets requirements of NFPA 90A and UL 181.
- Available with electric or hot water supplementary heat.
- All controls are mounted on exterior of terminal providing ready access for field adjustment.
- Each terminal factory tested prior to shipment.
- Single point electrical and/or pneumatic main air connection.
- Discharge opening designed for flanged duct connection.
- Full primary air valve low voltage NEMA 1 type enclosure for factory mounted DDC and analog electronic controls.

Controls:

- Nailor EZvav
- Analog electronic and pneumatic controls. Factory supplied, mounted and calibrated.
- Digital controls. Factory mounting and wiring of DDC controls supplied by BMS Controls Contractor.

Options:

- ECM/EPIC Fan Technology®.
- Primary air valve enclosure for field mounted controls.
- Induced air filter, 1" (25) thick, disposable type.
- Toggle disconnect switch (except units with electric heat, when disconnect is an electric heat option and includes fan).
- Various IAQ linings are available.
- Fan airflow or P.E. switch for night shutdown (pneumatic controls).
- Fan airflow switch for night shutdown (analog electronic controls).
- Night setback fan/heat cycle (pneumatic and analog).
- Fan unit fusing.
- Hanger brackets.
- FN2 90° Line Voltage controls enclosure on model 37S and 37SW (standard on 37SE).
- FN3 Remote Line Voltage control enclosure.



Intertek

FAN POWERED TERMINAL UNITS

Dimensions

Model Series 37S • Low Profile • Series Flow • Unit Sizes 1 – 3

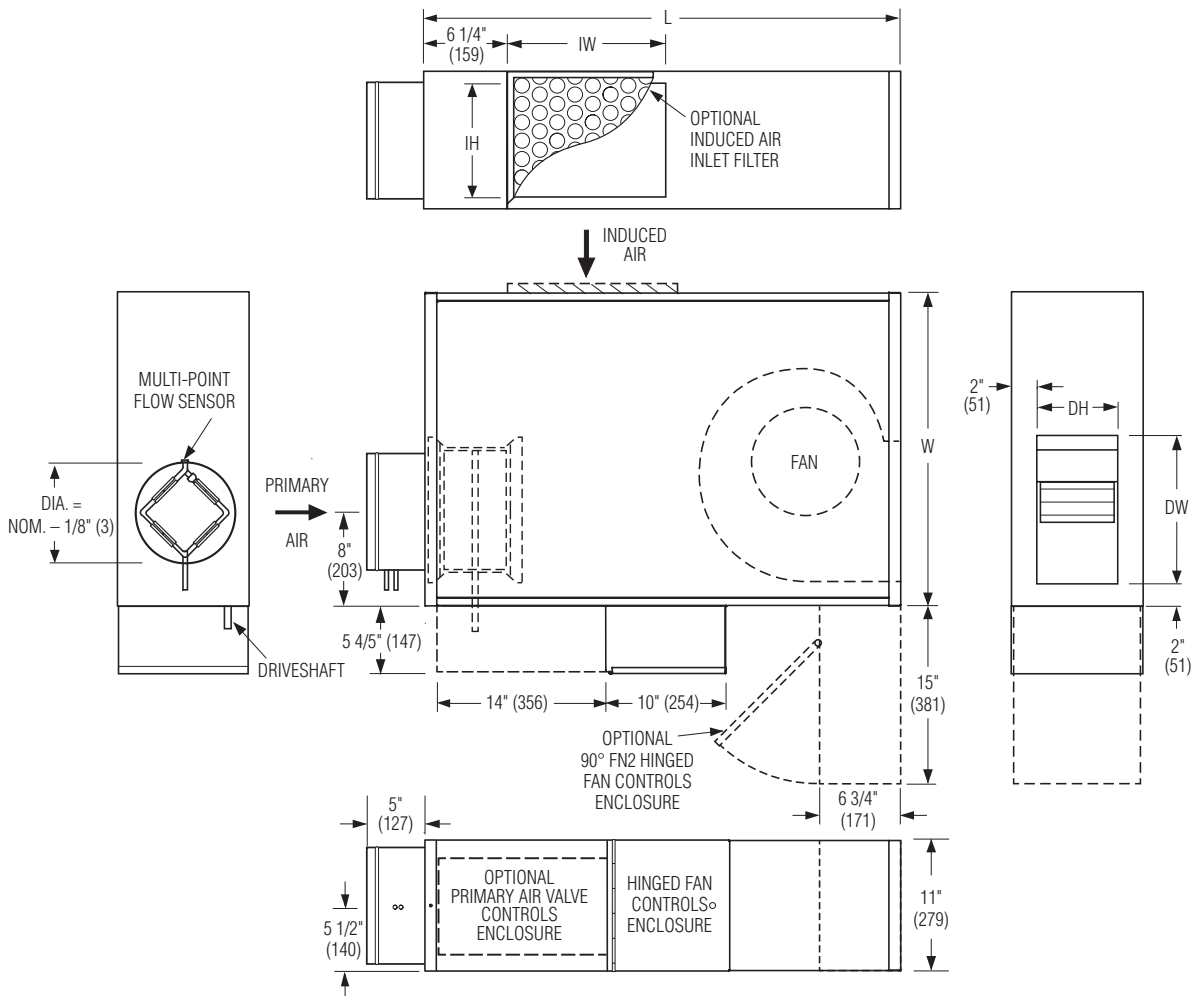

FAN POWERED TERMINAL UNITS

Dimensional Data

Unit Size	Inlet Size	W	L	Induced Air Inlet IW x IH	Outlet Discharge DW x DH	Filter Size
1	4, 5, 6, 8 (102, 127, 152, 203)	19 (483)	36 (914)	6 x 8 (152 x 203)	10 3/8 x 6 7/8 (264 x 175)	8 x 10 (203 x 254)
2	6, 8, 10 (152, 203, 254)	26 1/2 (673)	40 1/4 (1022)	15 3/4 x 8 (400 x 203)	11 3/8 x 6 7/8 (289 x 175)	18 x 10 (457 x 254)
3	6, 8, 10 (152, 203, 254)	26 1/2 (673)	40 1/4 (1022)	15 3/4 x 8 (400 x 203)	12 3/8 x 6 7/8 (314 x 175)	18 x 10 (457 x 254)

Dimensions

Model Series 37S • Low Profile • Series Flow • Unit Size 4

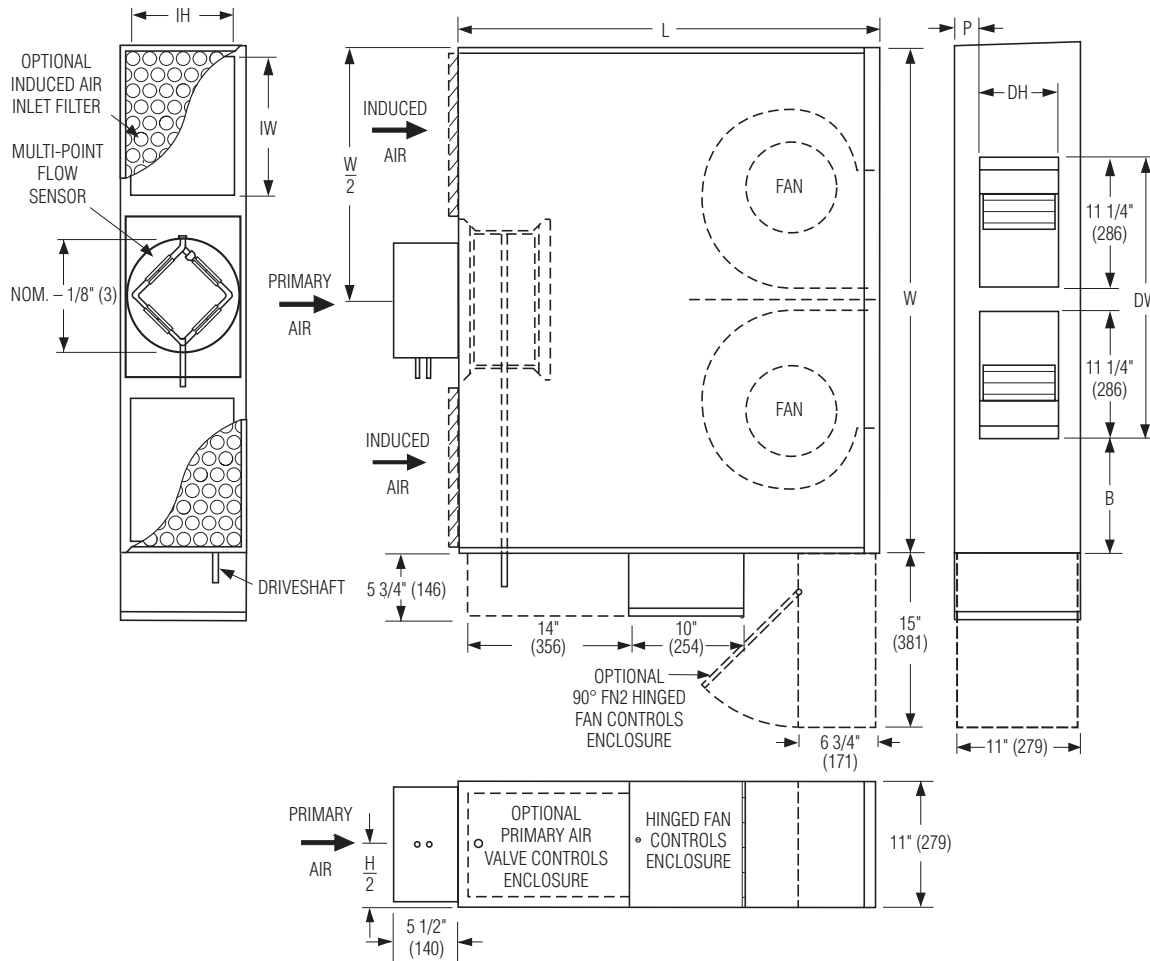

Dimensional Data

Unit Size	Inlet Size	W	L	B	P	Induced Air Inlet IW x IH	Outlet Discharge DW x DH	Filter Size
4	10 (254) Round 14 x 10 (356 x 254) Rect.	44 (1118)	36 1/2 (927)	9 3/4 (248)	2 1/16 (52)	12 x 9 (305 x 229) Qty. of 2	24 1/2 x 6 7/8 (622 x 175)	14 x 10 (356 x 254) Qty. of 2

Dimensions

Model Series 37S • Low Profile • Series Flow

Hot Water Coil Section

Model 37SW

Available in one, two or three row. Coil section installed on unit discharge. Right hand coil connection looking in direction of airflow standard (shown). Left hand is optional.

Standard Features:

- Coil section installed on unit discharge.
- Coil (and header on multi-circuit units) is installed in insulated casing for increased thermal efficiency.
- 1/2" (13) copper tubes.
- Aluminum ripple fins.
- Sweat Connections:
All size: 1 Row 1/2" (13), 2 and 3 Row 7/8" (22); O.D. male solder.
- Top and bottom access panels for inspection and coil cleaning.
- Flanged outlet duct connection.

Unit Sizes 1 – 3

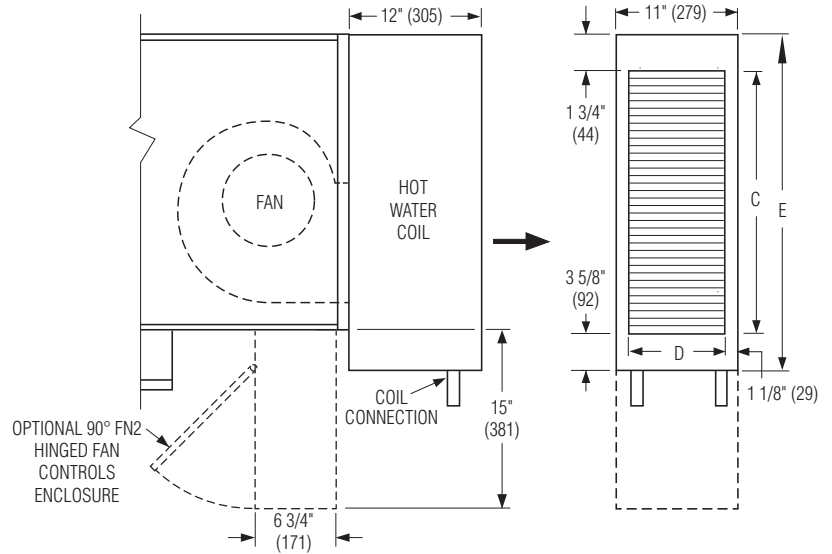

Unit Size 4

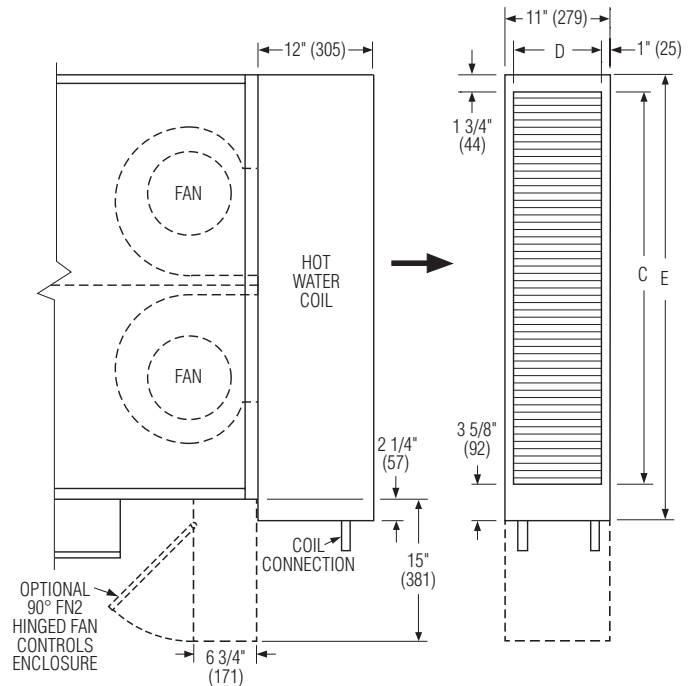

Unit Size	Outlet Duct Size C x D	E
1	14 5/8 x 8 3/4 (371 x 222)	20 (508)
2, 3	24 x 9 (610 x 229)	29 3/8 (746)
4	41 x 9 (1041 x 229)	46 3/8 (1178)

Dimensions

Model Series 37S • Low Profile • Series Flow

Electric Coil Section

Model 37SE

Standard Features:

- Controls enclosure incorporates a hinged access door opening upstream that helps ensure NEC clearance requirements and reduces footprint.
- Coil installed on unit discharge.
- Insulated coil element wrapper.
- Automatic reset high limit cut-outs (one per element).
- Single point electrical connection for entire terminal unit.
- Positive pressure airflow switch.
- Magnetic contactors per stage.
- Class A 80/20 Ni/Cr wire.
- Flanged outlet duct connection.
- Terminal unit with coil is ETL Listed as an assembly.
- Controls mounted as standard on RH side as shown. Terminals ordered with LH controls (optional) are inverted.

Standard Supply Voltage (60 Hz):

- Single phase: 120, 208, 240 & 277V.
- Three phase: 208, 480 (4 wire wye) and 600V (dual point connection).

Options:

- Toggle disconnect switch (includes fan).
- Door interlock disconnect switch.
- Mercury contactors.
- Power circuit fusing.
- Dust tight construction.
- Manual reset secondary thermal cut out.
- SCR Control.

Unit Sizes 1 – 3

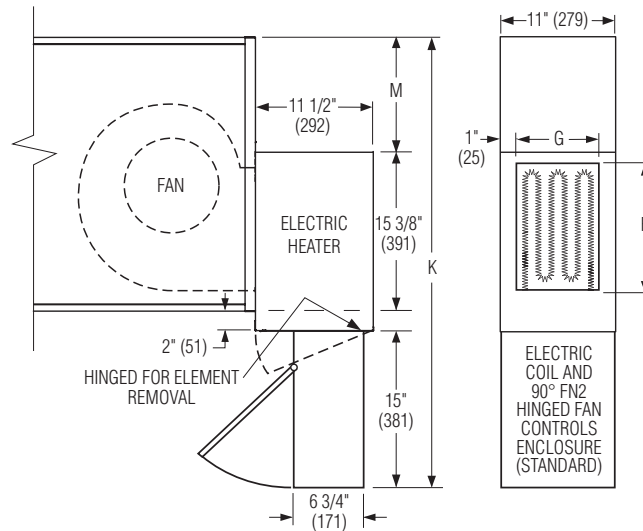

Unit Size 4

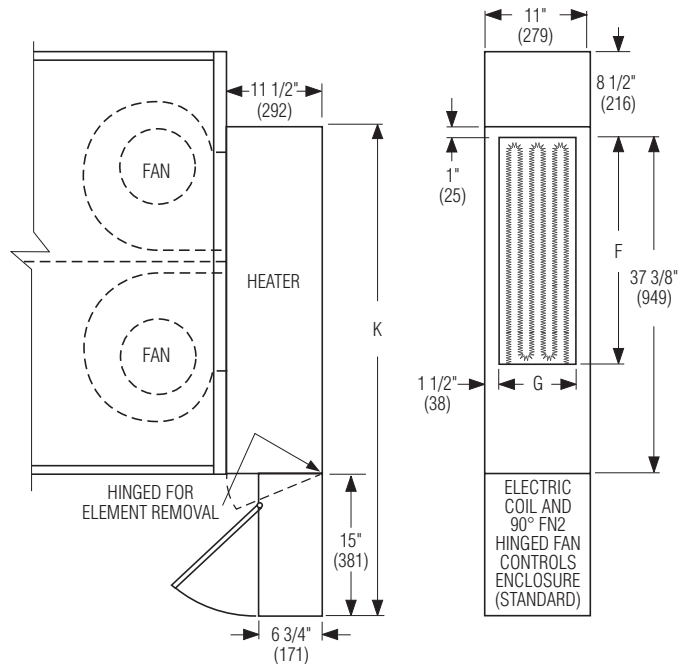

Unit Size	Outlet Duct Size F x G	M	K
1	12 3/8 x 9 (314 x 229)	3 5/8 (92)	35 7/8 (911)
2		11 1/8 (283)	43 1/2 (1105)
3		11 1/8 (283)	43 1/2 (1105)
4	25 x 8 (635 x 203)	—	52 3/8 (1330)

Performance Data

PSC Motor Fan Curves – Airflow vs. Downstream Static Pressure

37S Series • Low Profile • Series Flow

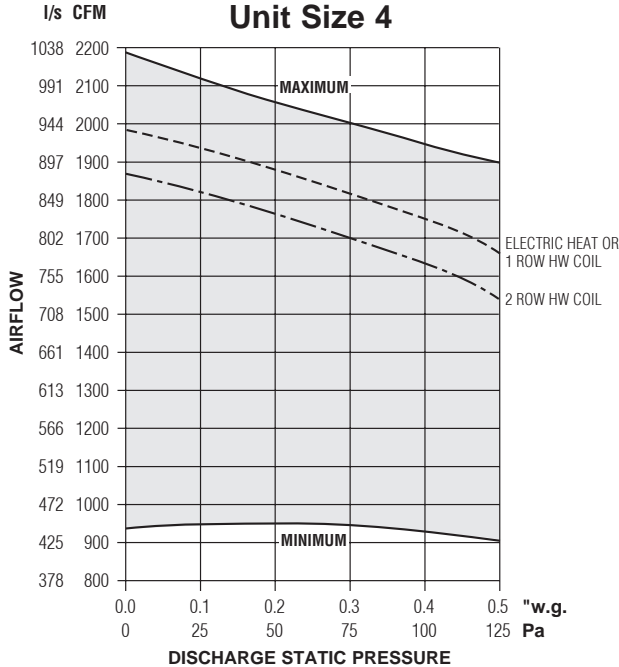
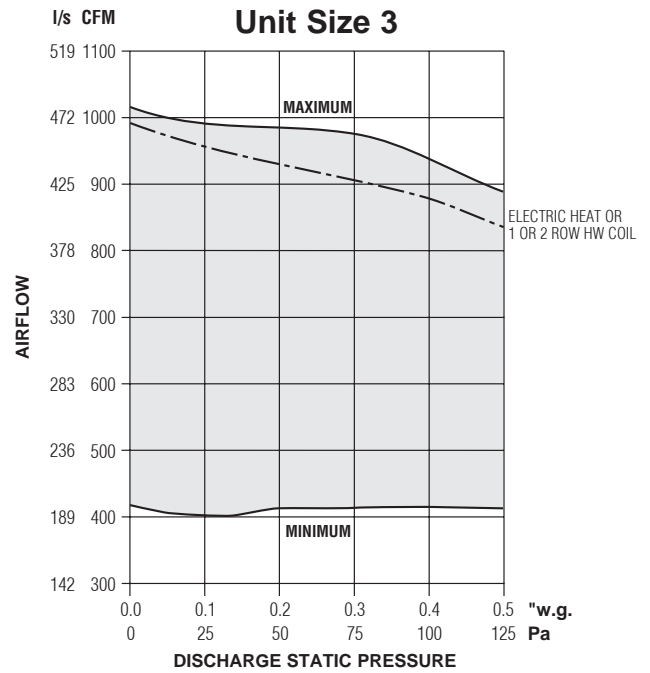
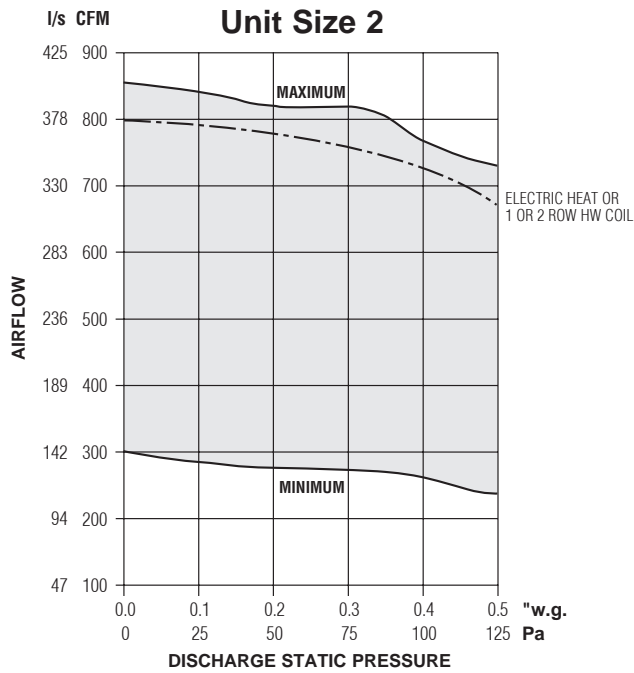

- Fan Curves shown are applicable to 120, 208, 240 and 277 volt, single phase PSC motors.

Electrical Data

Unit Size	PSC Motor HP	PSC Motor FLA			
		120V	208V	240V	277V
2	1/6	4.8	1.8	1.8	1.5
3	1/4	5.3	3.6	3.6	1.8
4	2@1/4	10.6	7.2	7.2	3.7

FLA = Full load amperage.
All motors are single phase/60 Hz.

Performance Data

ECM Motor Fan Curves – Airflow vs. Downstream Static Pressure

37S Series • Low Profile • Series Flow

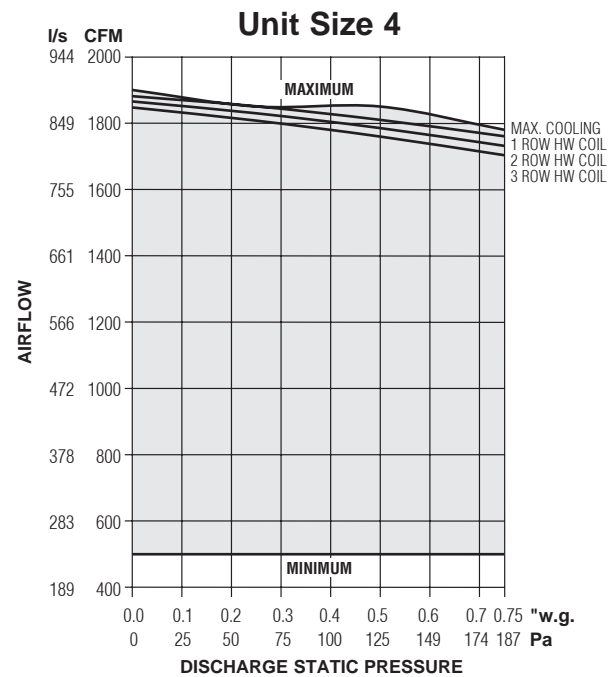
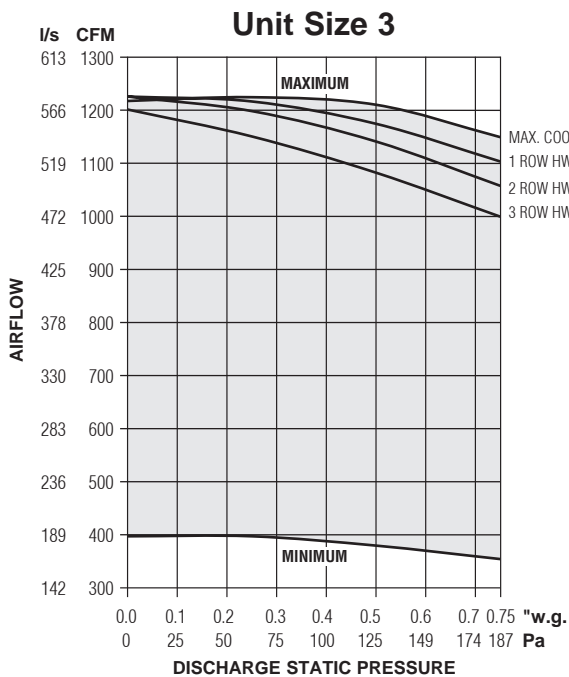
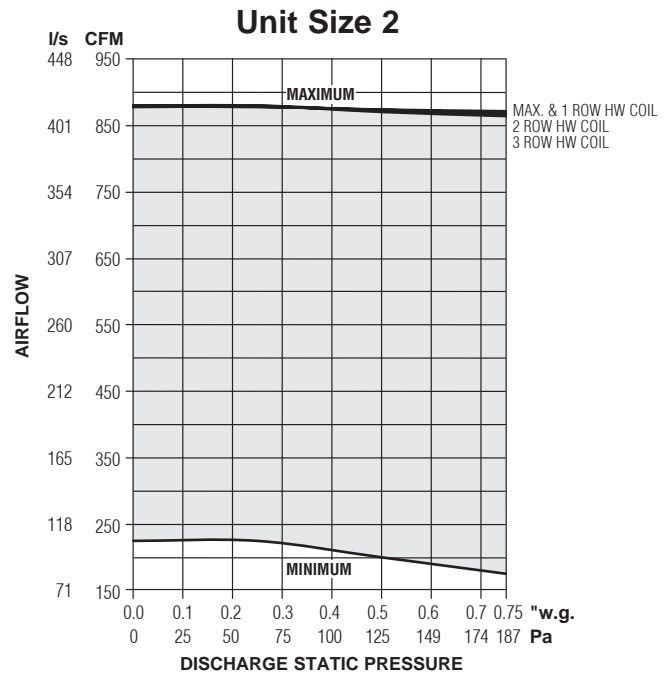
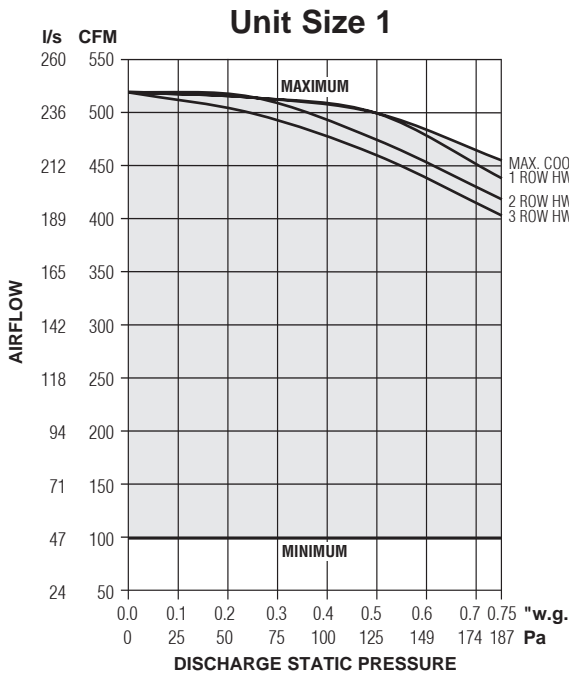

Electrical Data

Unit Size	EPIC ECM Motor FLA				
	Motor HP	120V	208V	240V	277V
1	*	1.9	1.3	1.3	1.3
2	*	3.3	2.2	2.2	2.2
3	*	6.9	4.7	4.4	4.4
4	*	8.0	5.4	5.2	4.9

* The EPIC ECM is a variable horsepower motor. Refer to Selectworks schedule for actual power consumption. FLA = Full load amperage. All motors are single phase/60 Hz.

NOTES:

- The ECM is pressure independent and constant volume in operation at factory or field set point within the shaded area. Airflow does not vary with changing static pressure conditions. The motor compensates for any changes in external static pressure or induced air conditions such as filter loading.
- Airflow can be set to operate on horizontal performance line at any point within shaded area using the solid state volume controller provided.
- Fan curves shown are applicable to 120, 208, 240 and 277 volt, single phase ECM's. ECM's, although DC in operation, include a built-in inverter.

Performance Data • NC Level Application Guide

Model Series 37S • Low Profile • Series Flow

Fiberglass Liner

Unit Size	Inlet Size	Airflow		Min. inlet ΔPs		NC Levels @ Inlet Pressure (ΔPs) shown											
						DISCHARGE					RADIATED						
						Fan Only	Min. ΔPs	0.5" w.g. (125 Pa)	1.0" w.g. (250 Pa)	1.5" w.g. (375 Pa)	2.0" w.g. (500 Pa)	Fan Only	Min. ΔPs	0.5" w.g. (125 Pa)	1.0" w.g. (250 Pa)	1.5" w.g. (375 Pa)	2.0" w.g. (500 Pa)
1	6	400	189	0.15	37	28	23	26	25	28	30	29	25	26	28	30	31
		300	142	0.07	17	23	-	23	23	23	25	20	23	23	24	26	28
		200	94	0.02	5	-	20	23	23	23	23	-	-	-	-	21	22
		100	47	0.01	1	-	-	-	-	-	-	-	-	-	-	-	-
	8	400	189	0.02	4	28	23	25	25	28	29	29	25	26	28	30	31
		300	142	0.01	2	23	-	21	20	21	24	20	22	23	24	26	28
		200	94	0.01	2	-	-	20	20	20	20	-	-	-	-	20	21
		100	47	0.01	2	-	-	-	-	-	-	-	-	-	-	-	-
2	6	550	260	0.21	52	-	-	-	-	20	23	25	25	26	28	30	31
		400	189	0.08	20	-	-	-	-	-	-	22	22	23	24	26	29
		275	130	0.01	2	-	-	-	-	-	-	-	20	21	22	25	29
	8	800	378	0.11	27	28	24	23	21	24	24	31	30	30	31	33	34
		700	330	0.08	19	24	23	20	21	23	25	29	28	28	30	31	34
		550	260	0.04	10	-	-	-	-	-	21	25	24	25	28	29	30
		400	189	0.02	4	-	-	-	-	-	-	22	22	23	24	25	28
		275	130	0.01	2	-	-	-	-	-	-	-	20	21	22	24	28
	10	800	378	0.03	7	28	24	21	21	23	24	31	30	30	31	33	34
		700	330	0.02	4	24	21	-	20	23	23	29	28	28	29	31	34
		550	260	0.01	2	-	-	-	-	-	20	25	24	25	26	29	30
		400	189	0.01	2	-	-	-	-	-	-	22	21	22	23	25	27
275		130	0.01	2	-	-	-	-	-	-	-	-	20	21	22	26	
3	6	550	260	0.22	55	23	25	28	29	31	31	28	28	28	30	31	34
		400	189	0.09	22	-	-	-	-	23	24	22	21	22	24	25	28
	8	1100	519	0.15	37	35	35	35	36	35	36	35	38	36	38	38	38
		900	425	0.09	22	31	31	31	33	33	33	31	34	34	34	34	35
		650	307	0.04	10	23	23	25	26	28	29	28	26	28	29	31	34
		400	189	0.01	2	-	-	-	-	20	21	22	21	21	23	25	28
	10	1150	543	0.05	12	36	35	35	35	35	35	36	38	38	38	38	38
		1100	519	0.05	12	35	35	34	35	35	35	35	38	36	38	38	38
		900	425	0.04	9	31	31	30	31	31	33	31	34	34	34	34	35
		650	307	0.02	4	23	21	23	24	25	26	28	26	26	29	31	34
		400	189	0.01	1	-	-	-	-	-	-	22	20	21	23	24	26
		-	-	-	-	-	-	-	-	-	-	-	-	-	-	-	-
4	10	1950	920	0.20	50	34	34	34	36	37	38	43	39	40	41	44	45
		1800	849	0.17	42	33	31	33	35	36	37	40	38	39	40	43	44
		1450	684	0.12	29	26	26	28	31	33	34	36	35	37	39	40	43
		1100	519	0.08	19	20	20	24	28	29	29	31	31	33	35	37	39
		800	378	0.05	11	-	-	-	-	20	20	28	26	29	32	34	36
	14 x 10	1950	920	0.13	32	34	33	33	35	36	37	43	39	40	41	44	45
		1800	849	0.12	30	33	31	31	34	35	36	40	38	39	40	43	44
		1450	684	0.08	20	26	25	26	30	31	33	36	34	36	38	40	41
		1100	519	0.05	11	20	-	23	25	26	28	31	31	32	34	37	38
		800	378	0.03	7	-	-	-	-	-	-	28	26	29	31	34	36
		-	-	-	-	-	-	-	-	-	-	-	-	-	-	-	-
		-	-	-	-	-	-	-	-	-	-	-	-	-	-	-	-

Performance Notes:

1. NC Levels are calculated based on procedures as outlined on page C160.
2. Dash (-) in space indicates a NC less than 20.

FAN POWERED TERMINAL UNITS

Performance Data • Discharge Sound Power Levels

Model Series 37S • Low Profile • Series Flow • Basic Unit

Fiberglass Liner



Unit Size	Inlet Size	Airflow		Min. inlet ΔPs		Fan Only		Fan and 100% Primary Air – Sound Power Octave Bands @ Inlet pressure (ΔPs) shown																																		
		cfm	l/s	"w.g.	Pa	Minimum ΔPs							0.5" w.g. (125Pa) ΔPs							1.0" w.g. (249Pa) ΔPs							1.5" w.g. (375Pa) ΔPs							2.0" w.g. (500Pa) ΔPs								
						2	3	4	5	6	7	2	3	4	5	6	7	2	3	4	5	6	7	2	3	4	5	6	7	2	3	4	5	6	7							
1	6	400	189	0.15	37	73	68	63	60	57	54	69	63	58	51	47	45	72	66	60	54	51	48	71	65	57	50	46	43	73	68	60	54	51	47	74	70	63	55	52	48	
		300	142	0.07	17	69	63	58	54	50	46	65	57	52	44	39	36	69	61	55	49	44	39	69	61	52	44	38	34	69	64	56	47	41	36	70	66	59	49	43	38	
		200	94	0.02	5	62	54	50	44	38	30	64	52	44	36	30	25	66	54	45	36	29	23	66	58	48	36	26	21	66	59	52	37	27	21	66	60	54	39	29	23	
		100	47	0.01	1	56	48	44	37	29	-	60	46	37	29	22	-	62	49	37	28	-	-	63	55	43	28	-	-	61	55	47	29	-	-	62	55	50	32	-	-	
	8	400	189	0.02	4	73	68	63	60	57	54	69	63	57	51	47	45	71	65	60	54	51	48	71	64	57	50	46	43	72	68	60	54	51	47	73	69	62	55	52	48	
		300	142	0.01	2	69	63	58	54	50	46	64	56	51	44	39	36	68	61	55	48	44	39	67	60	52	44	38	34	68	63	55	46	41	36	69	65	58	48	43	38	
		200	94	0.01	2	62	54	50	44	38	30	62	51	43	36	30	25	64	53	44	36	29	23	64	57	47	35	26	21	64	58	51	37	27	21	64	59	53	39	29	23	
		100	47	0.01	2	56	48	44	37	29	-	58	45	37	29	22	-	61	47	36	28	-	-	61	54	43	28	-	-	60	54	46	28	-	-	60	53	49	31	-	-	
2	6	550	260	0.21	52	63	61	58	56	52	47	65	60	58	54	49	43	63	58	57	52	47	41	66	60	58	53	48	41	67	62	58	53	48	41	69	62	59	53	48	41	
		400	189	0.08	20	59	56	54	51	47	39	62	57	56	51	45	36	62	56	55	49	43	34	63	58	55	49	43	34	65	59	56	49	43	34	65	59	56	49	43	34	
		275	130	0.01	2	56	51	50	46	40	30	61	53	51	46	40	29	60	53	50	44	37	26	60	54	51	44	37	24	63	56	52	44	37	25	62	56	52	44	37	26	
		800	378	0.11	27	71	69	66	63	60	58	68	66	62	58	55	51	67	65	61	57	53	50	68	64	61	57	53	49	70	66	61	57	53	50	70	66	62	58	54	50	
	8	700	330	0.08	19	67	65	62	60	56	53	67	64	61	57	53	48	66	62	59	55	51	47	67	63	60	56	51	47	69	64	60	56	51	47	71	65	61	56	52	47	
		550	260	0.04	10	63	61	58	56	52	47	64	60	58	54	49	43	62	58	56	52	47	41	64	60	57	53	48	41	66	61	58	53	48	41	68	62	58	53	48	41	
		400	189	0.02	4	59	56	54	51	47	39	60	55	55	50	45	36	60	55	54	49	43	34	61	56	54	49	43	34	63	58	55	48	43	34	63	58	55	49	43	34	
		275	130	0.01	2	56	51	50	46	40	30	59	52	50	45	39	28	58	52	49	44	37	25	58	53	50	43	36	24	62	54	51	43	36	25	60	54	51	44	36	25	
	10	800	378	0.03	7	71	69	66	63	60	58	68	66	61	58	55	51	67	64	60	57	53	50	67	64	60	57	53	49	69	65	61	57	53	50	70	66	61	58	54	50	
		700	330	0.02	4	67	65	62	60	56	53	66	63	60	57	53	48	65	61	59	55	51	47	66	62	59	55	51	47	68	64	60	56	51	47	69	64	60	56	52	47	
		550	260	0.01	2	63	61	58	56	52	47	62	59	57	53	49	43	61	57	56	51	47	41	63	59	57	52	48	41	65	61	57	52	48	41	67	61	57	52	48	41	
		400	189	0.01	2	59	56	54	51	47	39	59	54	54	50	45	36	58	54	53	48	43	34	60	55	53	48	43	34	61	56	54	48	43	34	61	57	54	48	43	34	
	275	130	0.01	2	56	51	50	46	40	30	57	50	49	45	39	28	56	50	48	43	37	25	56	51	49	43	36	24	60	52	50	43	36	24	58	52	50	43	36	25		
	3	6	550	260	0.22	55	69	63	60	59	55	51	71	65	61	58	53	49	73	66	62	59	54	50	74	67	62	59	54	50	76	68	63	59	55	50	76	68	63	59	55	50
			400	189	0.09	22	62	57	55	52	47	42	64	59	57	52	48	42	63	59	56	52	47	41	66	61	56	52	47	41	69	63	57	52	48	42	70	63	58	52	48	42
			1100	519	0.15	37	78	75	70	70	68	65	78	75	69	68	66	63	78	75	69	68	66	63	79	76	70	68	66	63	80	75	70	68	66	63	80	76	70	68	66	63
900			425	0.09	22	75	72	68	67	64	61	76	72	67	66	63	60	76	72	66	66	63	60	77	73	67	66	63	60	79	73	67	66	63	60	79	73	68	66	63	60	
8		650	307	0.04	10	69	63	60	59	55	51	69	64	60	58	53	49	71	65	61	58	54	50	72	65	61	58	54	50	73	67	61	58	55	50	74	67	62	59	55	50	
		400	189	0.01	2	62	57	55	52	47	42	62	58	56	52	47	41	62	58	55	51	47	40	64	59	55	51	47	40	67	61	56	51	47	41	68	62	57	52	48	42	
		1150	543	0.05	12	78	76	71	70	68	65	77	75	69	68	66	64	78	75	69	68	66	63	78	75	69	68	66	64	79	75	70	68	66	63	79	75	70	68	66	63	
		1100	519	0.05	12	78	75	70	70	68	65	77	75	69	68	66	63	77	74	68	68	66	63	78	75	69	68	66	63	79	75	69	68	66	63	79	75	69	68	66	63	
10		900	425	0.04	9	75	72	68	67	64	61	74	72	66	65	63	60	75	71	66	65	63	60	76	72	66	65	63	60	77	72	67	65	63	60	77	73	67	65	63	60	
		650	307	0.02	4	69	63	60	59	55	51	67	63	59	57	53	49	69	63	59	57	54	50	70	64	60	57	54	50	71	65	60	58	55	50	72	66	61	58	55	50	
		400	189	0.01	1	62	57	55	52	47	42	60	56	54	51	47	41	60	56	54	51	46	40	62	57	54	51	46	40	65	59	55	51	47	41	66	60	56	51	47	41	
		1950	920	0.20	50	79	74	73	74	71	69	77	74	73	72	70	67	77	74	73	73	71	68	79	76	75	74	72	69	80	77	76	75	72	70	81	78	76	75	73	70	
4	10	1800	849	0.17	42	77	73	72	72	70	67	76	72	71	71	68	66	76	73	72	72	69	67	78	75	73	73	70	68	79	76	75	73	71	69	80	77	75	74	71	69	
		1450	684	0.12	29	73	68	68	68	65	62	73	68	68	68	64	61	74	69	69	69	65	62	76	72	70	70	66	64	77	73	72	71	67	64	77	74	72	71	68	65	
		1100	519	0.08	19	67	63	64	62	59	55	67	63	64	62	58	55	71	66	66	65	61	57	73	69	68	66	62	59	74	70	69	67	63	60	74	70	69	67	63	60	
		800	378	0.05	11	62	57	59	57	54	48	62	57	60	57	53	47	65	60	61	59	55	49	66	62	62	60	56	51	68	63	63	61	56	51	68	63	63	61	57	52	
	14 x 10	1950	920	0.13	32	79	74	73	74	71	69	76	73	72	72	70	67	77	73	73	73	71	68	78	75	74	74	72	69	80	76	75	75	72	70	80	77	76	75	73	70	
		1800	849	0.12	30	77	73	72	72	70	67	75	72	71	71	68	66	76	72	72	72	69	67	77	74	73	73	70	68	78	75	74	73	71	69	79	76	74	74	71	69	
		1450	684	0.08</																																						

Performance Data • Radiated Sound Power Levels

Model Series 37S • Low Profile • Series Flow • Basic Unit

Fiberglass Liner



Unit Size	Inlet Size	Airflow		Min. inlet ΔPs		Fan Only		Fan and 100% Primary Air – Sound Power Octave Bands @ Inlet pressure (ΔPs) shown																																		
								Minimum ΔPs					0.5" w.g. (125Pa) ΔPs					1.0" w.g. (249Pa) ΔPs					1.5" w.g. (375Pa) ΔPs					2.0" w.g. (500Pa) ΔPs														
								2	3	4	5	6	7	2	3	4	5	6	7	2	3	4	5	6	7	2	3	4	5	6	7	2	3	4	5	6	7					
1	6	400	189	0.15	37	65	59	54	52	44	37	62	56	51	49	41	33	62	57	51	49	45	42	63	58	52	51	49	47	64	60	53	53	52	53	65	61	54	54	54	56	
		300	142	0.07	17	56	50	46	43	34	26	58	53	49	45	37	30	59	53	49	46	43	40	60	55	50	48	46	44	60	57	51	50	49	49	61	58	52	51	51	52	
		200	94	0.02	5	49	45	43	39	29	20	50	44	42	39	28	19	51	46	42	41	37	34	52	49	44	44	40	39	53	51	47	46	44	44	54	53	48	48	46	47	
		100	47	0.01	1	-	41	39	35	24	-	-	39	38	35	24	-	-	42	39	37	29	26	-	43	40	39	33	31	-	43	40	41	38	37	-	43	41	42	41	41	40
	8	400	189	0.02	4	65	59	54	52	44	37	62	56	51	48	40	33	62	57	51	49	45	41	63	58	52	51	48	47	64	60	53	52	52	52	65	61	54	53	54	56	
		300	142	0.01	2	56	50	46	43	34	26	58	53	48	45	36	29	59	53	49	46	42	39	60	55	50	48	45	44	60	57	51	49	48	48	61	58	52	50	51	51	
		200	94	0.01	2	49	45	43	39	29	20	50	44	42	38	28	19	51	46	42	41	36	33	52	49	44	43	40	38	53	51	46	45	43	43	54	53	47	47	45	46	
		100	47	0.01	2	-	41	39	35	24	-	-	39	38	34	23	-	-	42	39	36	29	25	-	42	39	38	33	30	-	43	40	40	37	36	-	43	41	41	39	39	
	2	6	550	260	0.21	52	59	52	51	51	41	32	56	51	51	51	40	33	57	52	52	51	45	46	59	55	53	53	49	51	62	58	55	55	54	56	63	60	56	57	57	60
			400	189	0.08	20	53	49	48	47	36	26	51	49	48	48	36	28	54	49	49	50	44	45	56	52	50	52	49	50	58	54	52	54	55	55	59	56	53	56	59	59
275			130	0.01	2	49	47	45	44	33	22	49	47	46	44	33	22	52	48	47	48	43	39	53	50	48	49	49	47	54	52	49	51	55	55	55	54	50	52	59	61	
8		800	378	0.11	27	67	60	56	56	48	40	63	58	55	56	46	38	64	58	55	56	48	47	65	60	56	57	52	53	66	62	57	59	55	58	66	63	58	60	60	61	
		700	330	0.08	19	64	57	54	54	45	37	60	55	53	54	43	36	61	56	53	55	46	47	62	59	55	56	51	52	64	61	56	57	55	57	65	63	57	57	57	61	
		550	260	0.04	10	59	52	51	51	41	32	56	51	50	51	39	33	57	52	51	51	44	45	59	55	53	53	49	50	62	58	54	55	54	55	63	60	55	56	57	59	
		400	189	0.02	4	53	49	48	47	36	26	51	49	48	47	36	27	54	49	49	49	43	43	56	52	50	51	48	48	58	54	51	53	54	54	59	56	53	54	58	57	
275		130	0.01	2	49	47	45	44	33	22	49	46	46	43	32	22	52	48	47	47	42	38	53	50	48	48	48	46	54	52	49	50	54	54	54	53	49	51	58	59		
10		800	378	0.03	7	67	60	56	56	48	40	63	58	55	55	46	38	64	58	55	55	48	47	65	60	56	57	51	52	66	62	57	58	54	57	66	63	58	59	59	61	
		700	330	0.02	4	64	57	54	54	45	37	60	55	53	53	43	35	61	56	53	54	46	46	62	59	54	55	50	51	64	61	56	56	54	56	65	63	57	57	57	60	
	550	260	0.01	2	59	52	51	51	41	32	56	51	50	50	39	32	57	52	51	50	44	44	59	55	52	52	49	49	62	58	54	54	53	54	63	60	55	55	56	58		
	400	189	0.01	2	53	49	48	47	36	26	51	49	47	46	35	26	54	49	48	48	42	42	56	52	49	50	48	47	58	54	51	52	53	52	59	56	52	53	57	56		
275	130	0.01	2	49	47	45	44	33	22	48	46	45	42	31	21	51	48	46	46	41	37	52	49	47	48	47	45	53	51	48	49	52	52	54	53	49	50	56	57			
3	6	550	260	0.22	55	63	54	53	52	43	34	62	54	53	53	43	34	62	55	53	53	46	48	63	58	55	55	50	53	65	61	56	56	54	58	65	63	57	57	57	62	
		400	189	0.09	22	54	49	48	46	37	27	53	48	47	45	35	23	55	50	48	47	43	43	57	53	50	49	48	60	56	51	51	52	54	61	58	53	52	55	58		
	8	1100	519	0.15	37	70	63	59	59	52	44	72	65	59	61	54	50	71	65	60	60	54	50	72	65	60	61	55	54	72	66	61	62	56	59	70	67	62	63	57	62	
		900	425	0.09	22	67	59	56	56	49	40	69	61	57	57	48	39	69	61	57	57	50	49	69	62	58	58	52	53	69	63	59	59	54	58	70	64	60	59	55	62	
		650	307	0.04	10	63	54	53	52	43	34	62	54	52	52	42	33	62	55	53	52	45	46	63	58	54	54	49	51	65	61	55	55	53	57	65	63	56	56	56	60	
	400	189	0.01	2	54	49	48	46	37	27	53	47	47	45	34	22	54	49	47	46	42	41	57	52	49	48	46	47	59	56	51	50	51	52	61	58	52	51	54	56		
	10	1150	543	0.05	12	71	64	60	60	53	45	72	65	60	61	54	46	72	65	60	57	51	47	72	66	61	61	54	54	72	66	61	62	56	58	72	67	62	62	56	61	
		1100	519	0.05	12	70	63	59	59	52	44	72	65	59	60	53	50	71	65	60	60	53	49	72	65	60	61	54	54	72	66	61	61	55	58	72	67	62	62	56	61	
		900	425	0.04	9	67	59	56	56	49	40	69	61	56	56	48	39	69	61	57	57	49	48	69	62	58	57	51	52	69	63	59	58	53	57	70	64	59	59	55	60	
		650	307	0.02	4	63	54	53	52	43	34	62	54	52	51	41	32	62	55	52	51	45	45	63	58	54	53	48	50	65	61	55	54	52	55	65	63	56	55	55	58	
400	189	0.01	1	54	49	48	46	37	27	52	47	46	44	33	22	54	49	47	45	41	40	56	52	49	47	45	45	58	55	50	49	49	51	60	57	52	50	52	54			
4	10	1950	920	0.20	50	76	69	65	63	54	46	73	68	64	62	53	45	73	68	65	63	54	48	74	70	66	64	57	53	75	71	68	66	60	58	76	72	69	67	62	62	
		1800	849	0.17	42	74	67	64	61	52	44	72	66	63	60	51	43	72	67	64	61	53	47	73	69	65	63	56	53	74	70	67	65	60	58	75	72	68	66	62	62	
		1450	684	0.12	29	71	63	61	57	47	39	68	62	60	57	46	38	69	64	62	58	50	45	70	66	64	60	54	52	71	67	65	62	59	59	72	69	67	64	62	64	
		1100	519	0.08	19	64	58	56	52	41	32	64	58	56	52	41	32	63	59	58	55	48	44	65	62	60	57	54	51	67	65	62	60	59	59	69	66	64	62	63	65	
		800	378	0.05	11	60	54	53	48	36	26	56	53	52	47	35	24	59	55	54	51	48	42	61	58	57	54	51	63	61	59	57	60	59	65	63	61	59	64	65		
	14 x 10	1950	920	0.13	32	76	69	65	63	54	46	73	68	64	61	52	44	73	68	65	62	54	48	74	70	66	64	57	53	75	71	68	65	59	58	76	72	69	66	61	61	
		1800	849	0.12	30	74	67	64	61	52	44	72	66	63	60	50	42	72	67	64	61	53	47	73	69	65	62	56	52	74	70	67	64	59	58	75	72	68	65	61	62	
		1450	684	0.08	20	71	63	61	57	47	39	68	62	59	56	46	37	69	64	61	58																					

Performance Data • AHRI Certification and Performance Notes

Model Series 37S • Low Profile • Series Flow • Basic Unit • AHRI Certification Rating Points Fiberglass Liner

Unit Size	Inlet Size	Fan Airflow		Fan ^Σ Watts	Fan Only* @ .25" w.g. (62 Pa) ΔPs														Primary Airflow		Min. Inlet ΔPs		Fan + 100% Primary @ 1.5" w.g. (375 Pa) ΔPs w/ .25" w.g. (62 Pa) Discharge ΔPs						
					Discharge							Radiated											Radiated						
					2	3	4	5	6	7	2	3	4	5	6	7	cfm	l/s					"w.g.	Pa	2	3	4	5	6
1	8	400	189	140	73	68	63	60	57	54	65	59	54	52	44	37	400	189	0.02	4	64	60	53	52	52	52			
2	10	800	378	170	71	69	66	63	60	58	67	60	56	56	48	40	800	378	0.03	7	66	62	57	58	54	57			
3	10	1100	519	400	78	75	70	70	68	65	70	63	59	59	52	44	1100	519	0.05	12	72	66	61	61	55	58			
4	14 x 10	1800	849	600	77	73	72	72	70	67	74	67	64	61	52	44	1800	849	0.12	30	74	70	67	64	59	58			

^Σ Motor = ECM.

* Primary air valve is closed and therefore primary cfm is zero.



Ratings are certified in accordance with AHRI Standards.

Performance Notes for Sound Power Levels:

- Discharge (external) static pressure is 0.25" w.g. (63 Pa) in all cases, which is the difference (ΔPs) in static pressure from terminal discharge to the room.
Discharge Sound Power Levels (SWL) now include duct end reflection energy as part of the standard rating. Including the duct end correction provides sound power levels that would normally be transmitted into an acoustically, non-reflective duct. The effect of including the energy correction to the discharge SWL, is higher sound power levels when compared to previous AHRI certified data. For more information on duct end reflection calculations see AHRI Standard 880.
- Radiated sound power is the breakout noise transmitted through the unit casing walls.
- Sound power levels are in decibels, dB re 10⁻¹² watts.

- All sound data listed by octave bands is raw data without any corrections for room absorption or duct attenuation. Dash (-) in space indicates sound power level is less than 20 dB or equal to background.
- Min. inlet ΔPs is the minimum operating pressure of the primary air valve section.
- Asterisk (*) in space indicates that the minimum inlet static pressure requirement is greater than 0.5" w.g. (125 Pa) at rated airflow.
- Data derived from independent tests conducted in accordance with ANSI / ASHRAE Standard 130 and AHRI Standard 880.

**SERIES FLOW
CONSTANT OR
VARIABLE VOLUME**

37SST STEALTH™ SERIES

- LOW PROFILE
- QUIET OPERATION

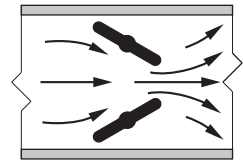

Inclined opposed blade damper configuration minimizes noisy turbulence and provides smooth, accurate, near linear flow control.

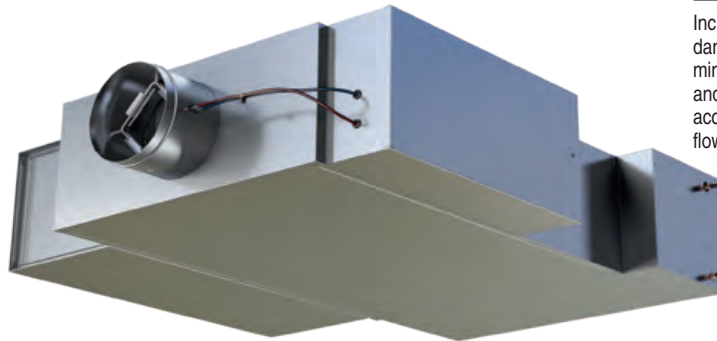

Model 37SWST

Models:

- 37SST** No Heat
- 37SEST** Electric Heat
- 37SWST** Hot Water Heat

The **37SST Stealth™** Series are only 11" (279) high and have been specifically designed for shallow ceiling plenum applications, which are common where zoning requirements limit building height and the architect wishes to maximize the number of floors. Utilizing Stealth™ design technology, this terminal has industry leading low sound levels.

STANDARD FEATURES:

- 20 ga. (1.0) galvanized steel construction.
- 16 ga. (1.61) galvanized steel inclined opposed blade primary air damper. 45° rotation, CW to close. 1/2" (13) dia. plated steel drive shaft. An indicator mark on the end of the shaft shows damper-position. Leakage is less than 2% of nominal flow at 3" w.g. (750 Pa).
- Stealth™ design technology provides significant reductions in radiated sound levels.
- Perforated baffle on primary air discharge optimizes mixing with induced air for rapid and effective temperature equalization. The baffle also converts low frequency primary air valve generated sound into more readily attenuated higher frequencies.
- Pressure independent primary airflow control.
- Multi-point averaging Diamond Flow sensor.
- Terminal may be field installed either way up, providing the additional flexibility of right or left field connections.
- Access panels are full size on top and bottom of terminal for ease of maintenance and service.
- Energy efficient PSC fan motor with thermal overload protection.
- Motor blower assembly mounted

- on special 16 ga. (1.61) angles and isolated from casing with rubber isolators.
- Adjustable PSC solid state fan speed controller with minimum voltage stop.
- Hinged door on fan controls enclosure.
- 1/2" (13), dual density insulation. Exposed edges coated to prevent air erosion. Meets requirements of NFPA 90A and UL 181.
- Available with electric or hot water supplementary heat.
- All controls are mounted on exterior of terminal providing ready access for field adjustment.
- Each terminal factory tested prior to shipment.
- Single point electrical and/or pneumatic main air connection.
- Discharge opening designed for flanged duct connection.
- Full primary air valve low voltage NEMA 1 type enclosure for factory mounted DDC and analog electronic controls.

Controls:

- Nailor EZvav
- Analog electronic and pneumatic controls. Factory supplied, mounted and calibrated.
- Digital controls. Factory mounting and wiring of DDC controls supplied by BMS Controls Contractor.

Options:

- ECM/EPIC Fan Technology®.
- Primary air valve controls enclosure for field mounted controls.
- Induced air filter, 1" (25) thick, disposable type.
- Toggle disconnect switch (except units with electric heat, when disconnect is an electric heat option and includes fan).
- Various IAQ linings are available.
- Fan airflow or P.E. switch for night shutdown (pneumatic controls).
- Fan airflow switch for night shutdown (analog electronic controls).
- Night setback fan/heat cycle (pneumatic and analog).
- Fan unit fusing.
- Hanger brackets.
- FN2 90° Line Voltage controls enclosure on model 37SST and 37SWST (standard on 37SEST).
- FN3 Remote Line Voltage control enclosure.



Dimensions

Model Series 37SST Stealth™ • Low Profile • Unit Sizes 1 – 3

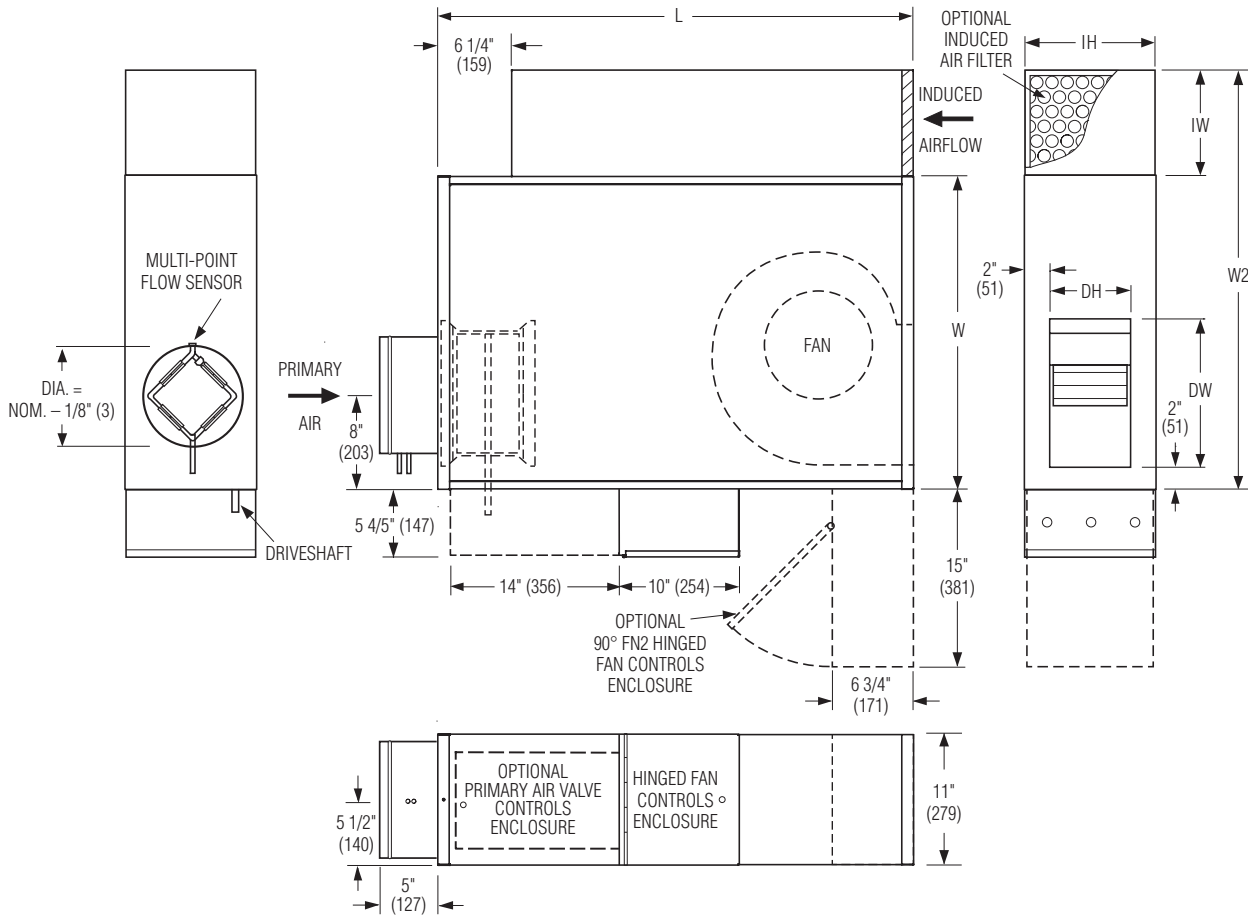

Dimensional Data

Unit Size	Inlet Size	W	W2	L	Induced Air Inlet IW x IH	Outlet Discharge DW x DH	Filter Size
1	4, 5, 6, 8 (102, 127, 152, 203)	19 (483)	28 (711)	36 (914)	9 x 11 (229 x 279)	10 3/8 x 6 7/8 (264 x 175)	9 x 11 (229 x 279)
2	6, 8, 10 (152, 203, 254)	26 1/2 (673)	35 1/2 (902)	40 1/4 (1022)	12 x 11 (305 x 279)	11 3/8 x 6 7/8 (289 x 175)	12 x 11 (305 x 279)
3	6, 8, 10 (152, 203, 254)	26 1/2 (673)	35 1/2 (902)	40 1/4 (1022)	12 x 11 (305 x 279)	12 3/8 x 6 7/8 (314 x 175)	12 x 11 (305 x 279)

Dimensions

Model Series 37SST Stealth™ • Low Profile • Unit Size 4

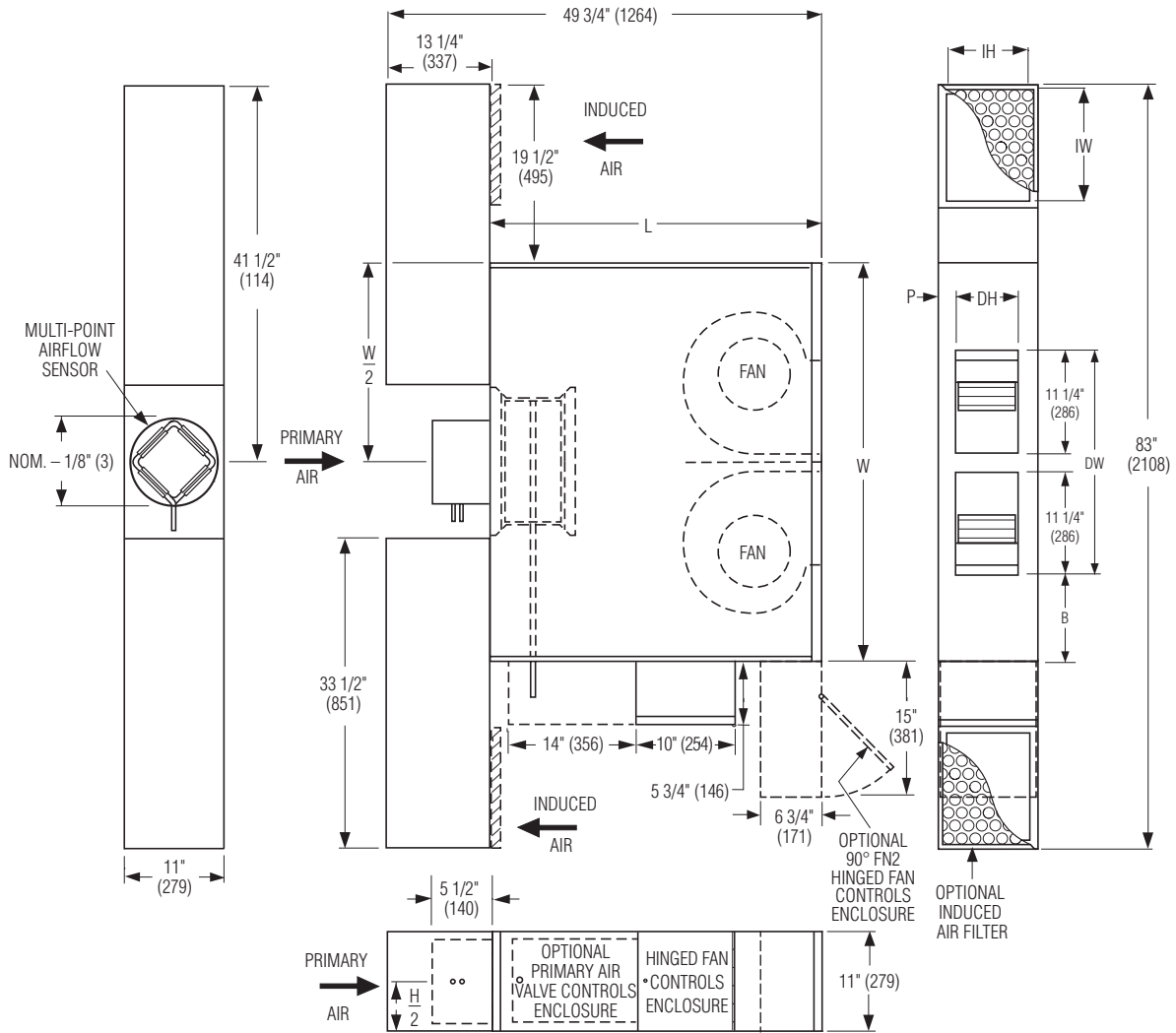

Dimensional Data

Unit Size	Inlet Size	W	L	B	P	Induced Air Inlet IW x IH	Outlet Discharge DW x DH	Filter Size
4	10 (254) Round 14 x 10 (356 x 254) Rect.	44 (1118)	36 1/2 (927)	9 3/4 (248)	2 1/16 (52)	12 x 9 (305 x 229) Qty. of 2	24 1/2 x 6 7/8 (622 x 175)	14 x 10 (356 x 254) Qty. of 2

Dimensions

Model Series 37SST Stealth™ • Low Profile • Series Flow

Hot Water Coil Section

Model 37SWST

Available in one, two or three row. Coil section installed on unit discharge. Right hand coil connection looking in direction of airflow standard (shown). Left hand is optional (terminals are inverted). Connections must be selected same hand as controls enclosure location.

Standard Features:

- Coil section installed on unit discharge.
- Coil (and header on multi-circuit units) is installed in insulated casing for increased thermal efficiency.
- 1/2" (13) copper tubes.
- Aluminum ripple fins.
- Sweat Connections:
All size: 1 Row 1/2" (13), 2 and 3 Row 7/8" (22); O.D. male solder.
- Top and bottom access panels for inspection and coil cleaning.
- Flanged outlet duct connection.

Unit Sizes 1 — 3

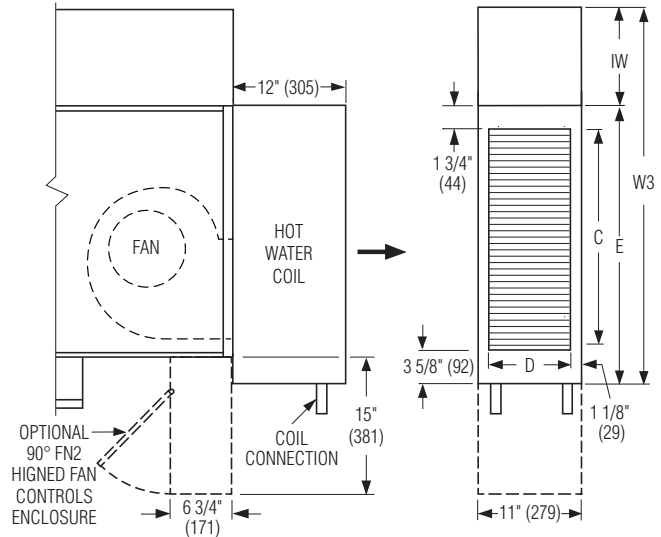

Unit Size 4

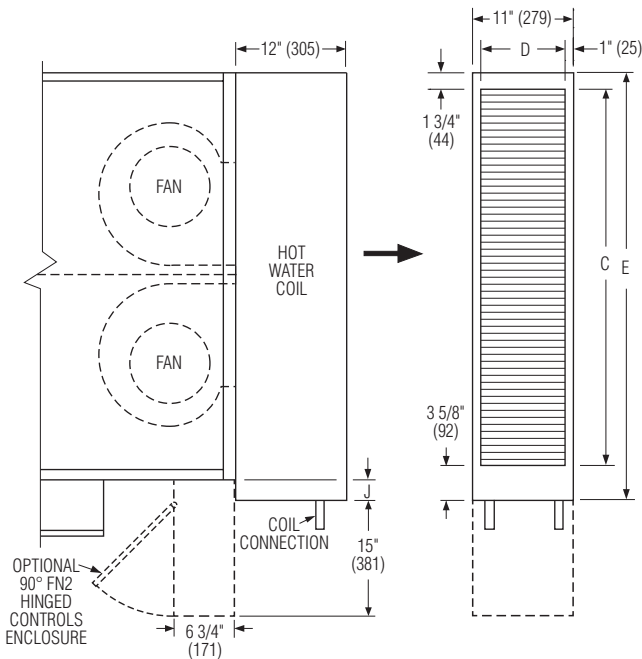

Unit Size 4 with FN2 Option

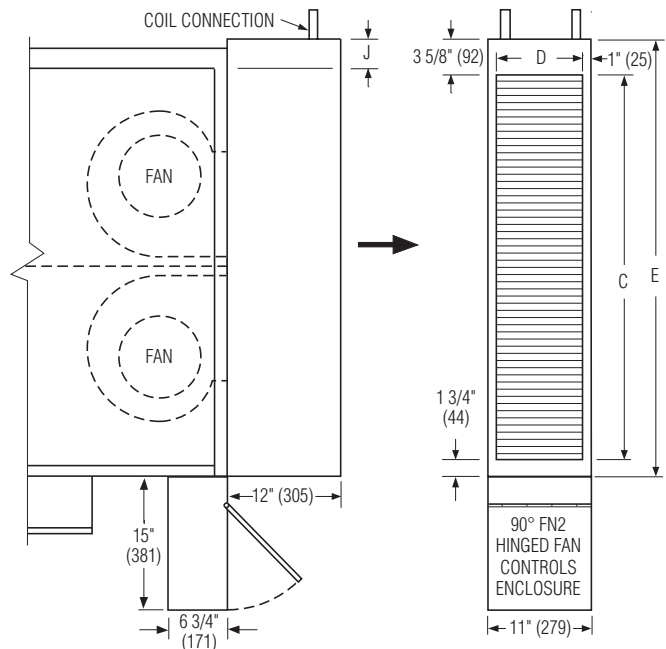

Unit Size	Outlet Duct Size C x D	IW	W3	E
1	14 5/8 x 8 3/4 (371 x 222)	9 (229)	29 (737)	20 (508)
2, 3	24 x 9 (610 x 229)	12 (305)	41 3/8 (1051)	29 3/8 (746)
4	41 x 9 (1041 x 229)	—	—	46 3/8 (1178)

Dimensions

Model Series 37SST Stealth™ • Low Profile • Series Flow

Electric Coil Section

Model 37SEST

Standard Features:

- Controls enclosure incorporates a hinged access door opening downstream that helps ensure NEC clearance requirements and reduces footprint.
- Coil installed on unit discharge.
- Insulated coil element wrapper.
- Automatic reset high limit cut-outs (one per element).
- Single point electrical connection for entire terminal unit.
- Positive pressure airflow switch.
- Magnetic contactors per stage.
- Class A 80/20 Ni/Cr wire.
- Flanged outlet duct connection.
- Terminal unit with coil is ETL Listed as an assembly.
- Controls mounted as standard on RH side as shown. Terminals ordered with LH controls (optional) are inverted.

Standard Supply Voltage (60 Hz):

- Single phase: 120, 208, 240 & 277V.
- Three phase: 208, 480 (4 wire wye) and 600V (dual point connection).

Options:

- Toggle disconnect switch (includes fan).
- Door interlock disconnect switch.
- Mercury contactors.
- Power circuit fusing.
- Dust tight construction.
- Manual reset secondary thermal cut out.
- SCR Control.

Unit Sizes 1 — 3

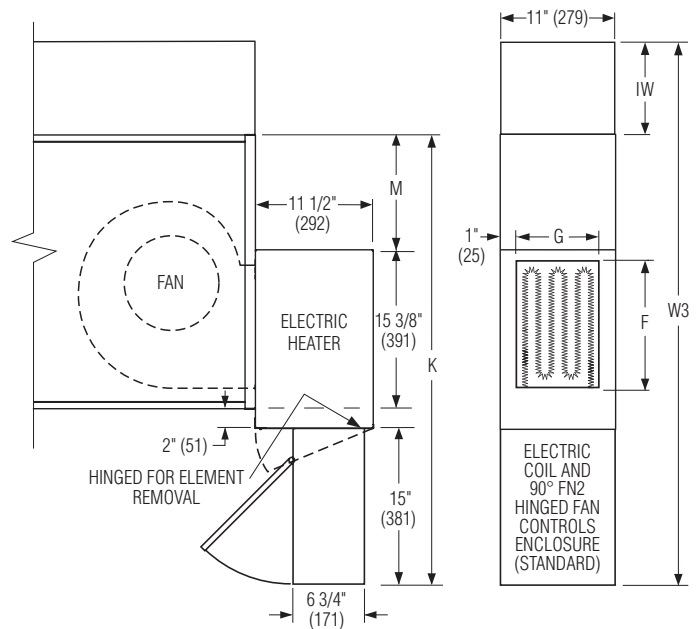

Unit Size 4

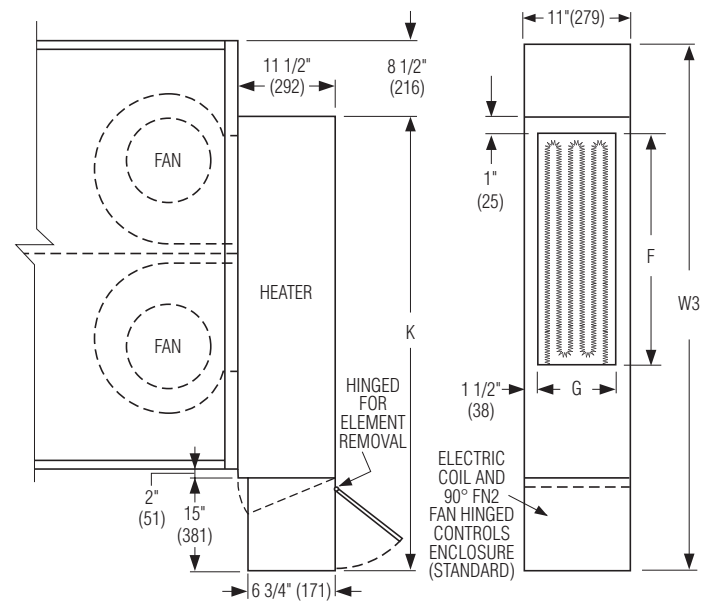

Unit Size	Outlet Duct Size F x G	IW	M	W3	K
1	12 3/8 x 9 (314 x 229)	9 (229)	3 5/8 (92)	44 7/8 (1140)	35 7/8 (911)
2			11 1/8 (283)	52 1/2 (1334)	43 1/2 (1105)
3			11 1/8 (283)	52 1/2 (1334)	43 1/2 (1105)
4	25 x 8 (635 x 203)	—	—	60 7/8 (1546)	52 3/8 (1330)

Performance Data

PSC Motor Fan Curves – Airflow vs. Downstream Static Pressure
37SST Stealth™ Series • Low Profile • Series Flow

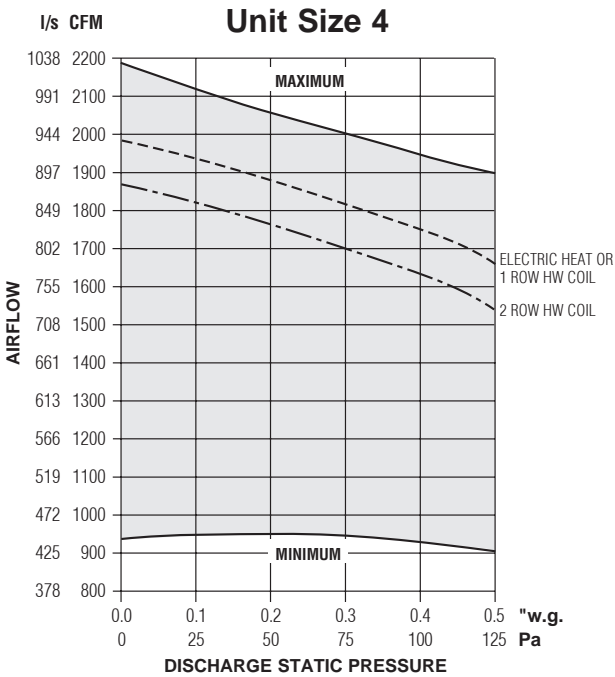
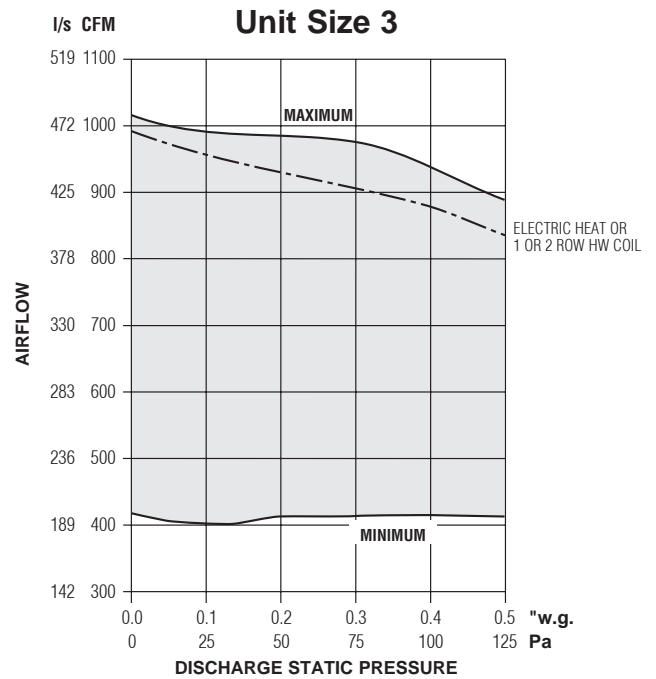
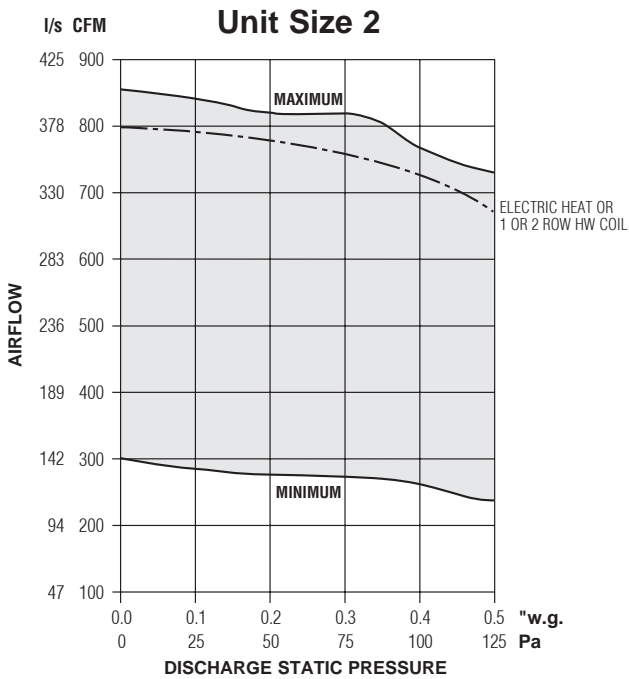

- Fan curves shown are applicable to 120, 208, 240 and 277 volt, single phase PSC motors.

Electrical Data

Unit Size	PSC Motor HP	PSC Motor FLA			
		120V	208V	240V	277V
2	1/6	4.8	1.8	1.8	1.5
3	1/4	5.3	3.6	3.6	1.8
4	2@1/4	10.6	7.2	7.2	3.7

FLA = Full load amperage.
All motors are single phase/60 Hz.

Performance Data

ECM Motor Fan Curves – Airflow vs. Downstream Static Pressure

37SST Stealth™ Series • Low Profile • Series Flow

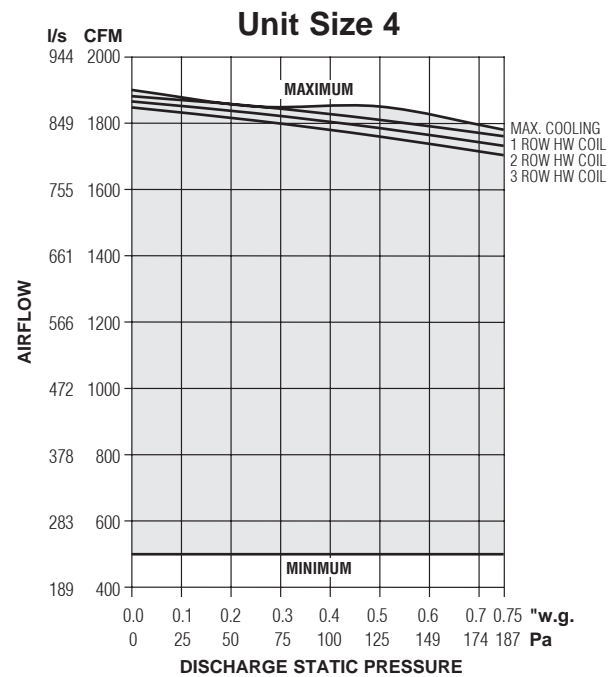
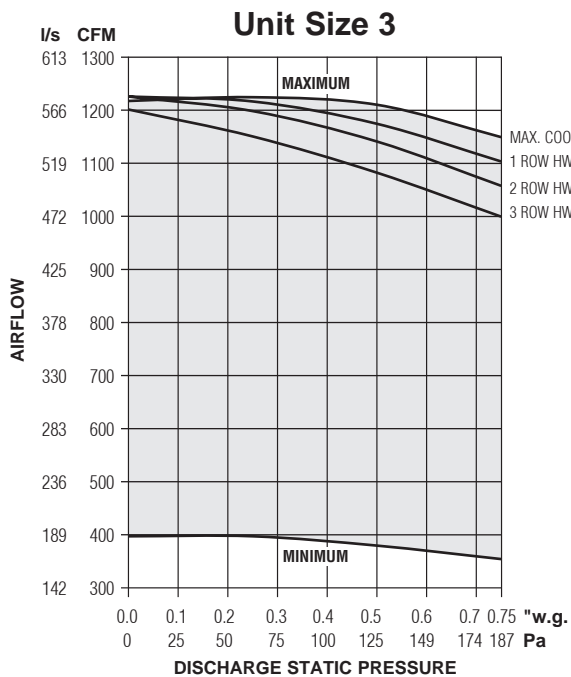
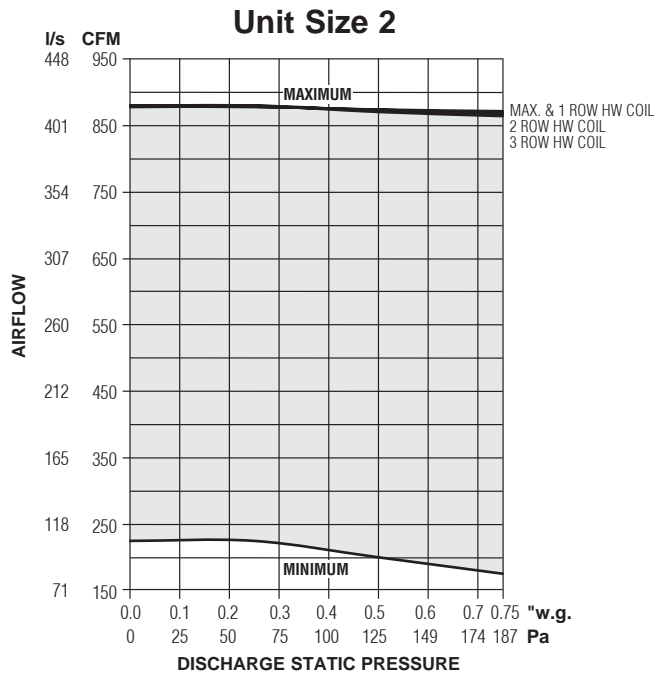
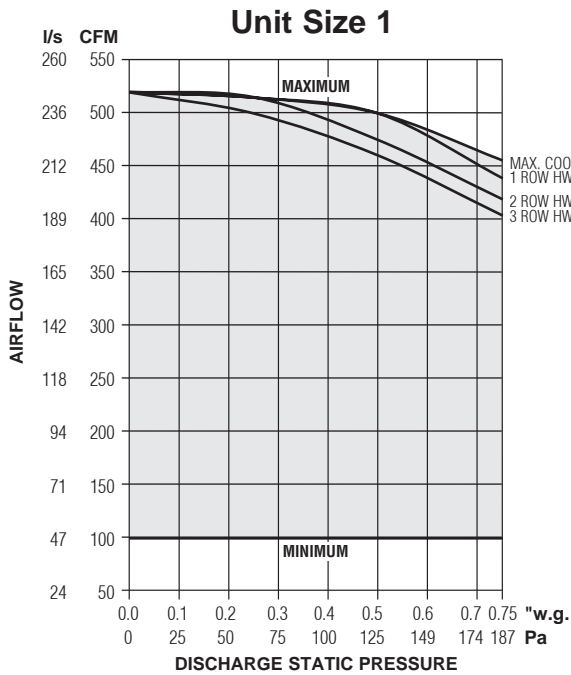

Electrical Data

Unit Size	EPIC ECM Motor FLA				
	Motor HP	120V	208V	240V	277V
1	*	1.9	1.3	1.3	1.3
2	*	3.3	2.2	2.2	2.2
3	*	6.9	4.7	4.4	4.4
4	*	8.0	5.4	5.2	4.9

* The EPIC ECM is a variable horsepower motor. Refer to Selectworks schedule for actual power consumption. FLA = Full load amperage. All motors are single phase/60 Hz.

NOTES:

- The ECM is pressure independent and constant volume in operation at factory or field set point within the shaded area. Airflow does not vary with changing static pressure conditions. The motor compensates for any changes in external static pressure or induced air conditions such as filter loading.
- Airflow can be set to operate on horizontal performance line at any point within shaded area using the solid state volume controller provided.
- Fan curves shown are applicable to 120, 208, 240 and 277 volt, single phase ECM's. ECM's, although DC in operation, include a built-in inverter.

Performance Data • NC Level Application Guide

Model Series 37SST Stealth™ • Low Profile • Series Flow

Fiberglass Liner

Unit Size	Inlet Size	Airflow		Min. inlet ΔPs		NC Levels @ Inlet Pressure (ΔPs) shown												
						DISCHARGE					RADIATED							
						Fan Only	Min. ΔPs	0.5" w.g. (125 Pa)	1.0" w.g. (250 Pa)	1.5" w.g. (375 Pa)	2.0" w.g. (500 Pa)	Fan Only	Min. ΔPs	0.5" w.g. (125 Pa)	1.0" w.g. (250 Pa)	1.5" w.g. (375 Pa)	2.0" w.g. (500 Pa)	
1	6	400	189	0.15	37	26	24	25	25	25	25	28	25	25	28	29	30	
		300	142	0.07	17	21	-	20	21	21	21	-	20	21	23	25	26	
		200	94	0.02	5	24	20	21	21	24	24	-	-	-	-	-	-	
		100	47	0.01	1	-	-	-	-	21	20	-	-	-	-	-	-	
	8	400	189	0.02	4	26	23	24	25	24	24	28	25	25	28	29	30	
		300	142	0.01	2	21	-	-	20	20	21	-	20	21	23	25	26	
		200	94	0.01	2	24	-	-	20	21	21	-	-	-	-	-	-	
		100	47	0.01	2	-	-	-	-	-	-	-	-	-	-	-	-	
2	6	550	260	0.21	52	20	-	20	-	20	20	22	22	23	24	26	29	
		400	189	0.08	20	-	-	-	-	20	20	-	-	20	22	24	28	
		275	130	0.01	2	-	-	20	-	20	23	-	-	-	-	24	28	
	8	800	378	0.11	27	28	24	21	21	23	23	29	28	26	29	31	34	
		700	330	0.08	19	25	23	20	21	21	23	26	25	26	28	30	33	
		550	260	0.04	10	20	-	-	-	-	-	22	21	22	24	26	29	
		400	189	0.02	4	-	-	-	-	-	-	-	-	-	21	23	26	
		275	130	0.01	2	-	-	-	-	-	20	-	-	-	-	23	27	
	10	800	378	0.03	7	28	24	20	20	21	21	29	28	26	29	31	34	
		700	330	0.02	4	25	21	-	20	21	21	26	24	25	28	30	33	
		550	260	0.01	2	20	-	-	-	-	-	22	21	22	24	26	29	
		400	189	0.01	2	-	-	-	-	-	-	-	-	-	21	23	25	
		275	130	0.01	2	-	-	-	-	-	-	-	-	-	-	21	25	
	3	6	550	260	0.22	55	21	25	26	28	29	30	24	23	23	24	28	30
			400	189	0.09	22	-	-	-	-	20	21	-	-	-	-	23	25
		8	1100	519	0.15	37	34	35	34	35	35	35	32	34	34	35	35	35
900			425	0.09	22	30	31	31	31	31	33	30	31	31	31	33	33	
650			307	0.04	10	21	23	24	25	26	28	24	23	23	24	28	30	
400			189	0.01	2	-	-	-	-	-	-	-	-	-	-	21	24	
10		1150	543	0.05	12	35	35	34	35	35	35	33	34	34	34	35	36	
		1100	519	0.05	12	34	34	33	34	34	35	32	34	34	35	35	35	
		900	425	0.04	9	30	30	30	30	31	31	30	31	31	31	33	33	
		650	307	0.02	4	21	21	21	23	24	25	24	23	23	24	28	30	
4	10	1950	920	0.20	50	35	34	35	36	37	38	38	39	39	40	41	43	
		1800	849	0.17	42	33	31	33	34	36	37	35	38	38	39	40	41	
		1450	684	0.12	29	26	25	28	30	31	33	31	33	34	35	36	38	
		1100	519	0.08	19	-	-	21	24	26	26	25	28	26	29	31	34	
		800	378	0.05	11	-	-	-	-	-	20	20	-	21	25	28	30	
	14 x 10	1950	920	0.13	32	35	33	34	35	36	37	38	39	39	40	41	43	
		1800	849	0.12	30	33	30	33	33	35	36	35	38	38	39	40	41	
		1450	684	0.08	20	26	25	26	29	30	31	31	33	34	35	36	38	
		1100	519	0.05	11	-	-	-	21	25	25	25	28	26	29	31	34	
		800	378	0.03	7	-	-	-	-	-	-	20	-	21	24	28	30	

Performance Notes:

1. NC Levels are calculated based on procedures as outlined on page C160.
2. Dash (-) in space indicates a NC less than 20.

Performance Data • Discharge Sound Power Levels

Model Series 37SST Stealth™ • Low Profile • Series Flow

Fiberglass Liner



Unit Size	Inlet Size	Airflow		Min. inlet ΔPs		Fan Only		Fan and 100% Primary Air – Sound Power Octave Bands @ Inlet pressure (ΔPs) shown																																		
								Minimum ΔPs							0.5" w.g. (125Pa) ΔPs							1.0" w.g. (249Pa) ΔPs							1.5" w.g. (375Pa) ΔPs							2.0" w.g. (500Pa) ΔPs						
								2	3	4	5	6	7	2	3	4	5	6	7	2	3	4	5	6	7	2	3	4	5	6	7	2	3	4	5	6	7					
1	6	400	189	0.15	37	72	67	62	58	54	50	70	64	59	51	47	41	71	64	58	51	47	42	71	66	59	52	49	44	71	65	57	46	39	31	70	66	58	46	40	32	
		300	142	0.07	17	68	62	57	52	47	41	66	58	53	45	39	33	67	59	53	45	39	33	67	63	55	46	41	36	68	62	54	40	31	22	68	63	56	42	33	24	
		200	94	0.02	5	67	60	54	49	43	36	64	52	45	37	30	22	65	54	45	36	29	20	65	58	48	33	24	-	67	62	56	42	34	28	67	63	57	44	35	28	
		100	47	0.01	1	63	56	50	44	37	29	60	47	38	30	23	-	61	49	39	29	-	-	62	54	43	25	-	-	65	61	55	39	31	24	64	61	56	41	32	24	
	8	400	189	0.02	4	72	67	62	58	54	50	69	63	58	51	47	41	70	64	58	51	47	42	70	66	58	52	49	44	70	65	56	46	39	31	70	65	58	46	40	32	
		300	142	0.01	2	68	62	57	52	47	41	65	57	52	44	39	33	66	58	52	45	39	33	66	62	54	46	41	36	67	62	53	40	31	22	67	63	55	42	33	24	
		200	94	0.01	2	67	60	54	49	43	36	62	51	44	37	30	22	63	53	44	36	29	20	64	57	47	33	24	-	65	61	55	42	34	28	65	61	56	43	35	28	
		100	47	0.01	2	63	56	50	44	37	29	58	45	37	29	22	-	59	48	38	29	-	-	60	52	42	24	-	-	63	60	54	39	30	24	62	59	55	41	32	24	
	2	6	550	260	0.21	52	63	62	59	56	53	48	65	60	58	54	49	43	67	58	57	52	47	41	65	60	58	53	47	41	67	61	58	53	47	41	67	62	58	53	47	41
			400	189	0.08	20	61	57	55	51	47	40	64	58	56	51	45	36	64	57	55	48	43	34	64	57	55	48	42	34	65	58	56	49	43	34	67	59	56	49	43	35
			275	130	0.01	2	59	52	50	46	40	30	62	58	51	46	40	29	64	53	49	43	36	24	63	55	51	43	36	25	64	56	52	44	37	26	66	56	53	45	38	28
		8	800	378	0.11	27	70	69	66	64	61	58	68	66	62	59	55	51	67	64	61	57	53	50	68	64	61	56	52	49	69	65	61	57	53	49	70	65	61	57	53	49
700			330	0.08	19	67	66	63	60	57	54	67	64	61	57	53	48	67	62	59	55	51	47	67	63	60	55	51	46	68	63	60	55	51	46	69	64	60	56	51	46	
550			260	0.04	10	63	62	59	56	53	48	64	60	58	54	49	43	65	58	56	52	47	41	64	60	57	52	47	41	65	60	57	52	47	41	66	61	58	52	47	41	
400			189	0.02	4	61	57	55	51	47	40	62	57	55	50	45	36	62	55	54	48	43	34	62	56	54	48	42	34	64	57	55	49	43	34	65	58	55	49	43	35	
10		275	130	0.01	2	59	52	50	46	40	30	60	56	50	45	39	28	62	52	49	43	36	24	61	53	50	43	36	25	62	54	51	44	37	26	64	55	52	44	37	28	
		800	378	0.03	7	70	69	66	64	61	58	68	66	61	59	55	51	66	63	60	57	53	50	67	63	61	56	52	49	68	64	60	57	53	49	69	64	61	57	53	49	
		700	330	0.02	4	67	66	63	60	57	54	66	63	60	57	53	48	66	61	59	55	51	47	66	62	59	55	51	46	67	63	59	55	51	46	68	63	59	55	51	46	
		550	260	0.01	2	63	62	59	56	53	48	63	59	57	53	49	43	64	57	56	51	47	41	63	59	57	52	47	41	64	60	57	51	47	41	65	61	57	52	47	41	
3		6	400	189	0.01	2	61	57	55	51	47	40	60	56	54	50	45	36	61	54	53	48	43	34	60	55	53	48	42	34	62	56	54	48	43	34	63	57	54	48	43	35
	275		130	0.01	2	59	52	50	46	40	30	58	54	49	45	39	28	60	50	48	42	35	24	60	51	49	43	36	24	60	53	50	44	36	26	62	53	51	44	37	27	
	550		260	0.22	55	68	63	60	59	55	51	71	65	61	58	53	49	72	66	61	58	53	49	73	66	61	58	53	49	74	67	62	58	54	49	75	68	62	59	54	49	
	8	400	189	0.09	22	63	58	56	53	49	44	62	59	56	51	47	41	64	59	56	52	47	41	65	61	56	52	47	41	67	62	57	52	47	41	68	63	57	52	47	41	
		1100	519	0.15	37	76	74	68	68	66	63	78	75	70	70	67	65	77	74	69	68	65	63	79	75	70	68	66	63	79	75	70	68	65	63	80	75	70	68	65	62	
		900	425	0.09	22	74	71	66	66	63	60	76	72	67	67	63	60	77	72	66	65	62	59	77	72	67	66	62	59	78	72	67	66	62	59	79	73	67	66	62	59	
		650	307	0.04	10	68	63	60	59	55	51	69	64	60	57	53	49	70	64	60	57	53	49	71	64	60	57	53	49	72	66	61	58	54	49	73	67	61	58	54	49	
	10	400	189	0.01	2	63	58	56	53	49	44	60	57	55	51	46	40	62	58	55	51	47	40	64	59	55	51	47	40	65	60	56	51	46	40	66	61	56	51	46	40	
		1150	543	0.05	12	77	75	69	68	66	64	77	75	70	70	68	65	77	74	69	68	66	63	78	75	69	68	66	63	79	75	69	68	66	63	80	75	69	68	66	63	
		1100	519	0.05	12	76	74	68	68	66	63	77	74	70	70	67	65	77	73	68	68	65	63	78	74	69	68	66	63	78	74	69	68	66	63	79	75	69	68	65	62	
		900	425	0.04	9	74	71	66	66	63	60	75	71	66	66	63	60	76	71	65	65	62	59	76	71	66	65	62	59	77	72	66	65	62	59	77	72	67	65	62	59	
	4	10	650	307	0.02	4	68	63	60	59	55	51	67	63	59	57	53	49	68	63	59	57	53	49	69	63	59	57	53	49	70	65	60	57	54	49	71	66	60	57	54	49
400			189	0.01	1	63	58	56	53	49	44	58	56	54	50	46	40	60	56	53	51	46	40	62	57	54	51	46	40	63	59	55	50	46	40	64	59	55	51	46	40	
1950			920	0.20	50	79	75	74	74	72	69	77	74	72	72	70	67	78	75	73	73	71	68	79	76	74	74	71	69	81	77	76	75	72	70	81	78	76	75	72	70	
1800			849	0.17	42	77	73	72	72	70	67	75	72	71	71	68	65	76	73	72	71	69	66	78	74	73	72	70	67	79	76	74	73	71	68	80	77	75	73	71	68	
14 x 10		1450	684	0.12	29	71	68	67	67	64	61	71	67	67	67	63	60	73	69	68	68	64	62	75	71	70	69	66	63	77	72	71	70	66	64	77	73	71	71	67	64	
		1100	519	0.08	19	64	60	62	61	58	54	65	61	63	60	56	52	68	64	64	62	59	55	70	66	66	64	60	56	72	68	67	65	61	57	73	68	68	65	61	58	
		800	378	0.05	11	59	57	59	58	54	48	59	56	59	56	52	45	63	58	60	58	54	48	64	60	61	58	55	49	66	62	62	59	56	50	67	63	63	60	56	51	
		1950	920	0.13	32	79	75	74	74	72	69	76	73	72	72	70	67	77	74	73	73	71	68	78	75	74	74	71	69	80	76	75	75	72	70	80	77	75	75	72	70	
10	1800	849	0.12	30	77	73	72	72	70	67	74	71	70	71	68	65	76	73	71	71	69	66	77	73	72	72	70	67	79	75	73	73	71	68	79	76	74	73	71	68		
	1450	684	0.08	20	71	68	67	67	64	61	70	67	66	66	63	60	72																									

Performance Data • Radiated Sound Power Levels

Model Series 37SST Stealth™ • Low Profile • Series Flow

Fiberglass Liner



Unit Size	Inlet Size	Airflow		Min. inlet ΔPs		Fan Only		Fan and 100% Primary Air – Sound Power Octave Bands @ Inlet pressure (ΔPs) shown																																		
								Minimum ΔPs							0.5" w.g. (125Pa) ΔPs							1.0" w.g. (249Pa) ΔPs							1.5" w.g. (375Pa) ΔPs							2.0" w.g. (500Pa) ΔPs						
								"w.g.	Pa	2	3	4	5	6	7	2	3	4	5	6	7	2	3	4	5	6	7	2	3	4	5	6	7	2	3	4	5	6	7			
1	6	400	189	0.15	37	63	58	52	47	42	36	60	56	49	44	39	33	60	56	49	45	40	34	61	58	50	46	42	37	62	59	50	46	44	40	63	60	51	47	45	43	
		300	142	0.07	17	55	51	44	38	33	26	56	52	46	41	35	29	58	53	47	41	36	30	58	54	47	42	38	34	58	56	48	43	40	37	59	57	49	43	41	40	
		200	94	0.02	5	50	45	41	34	27	19	-	43	39	33	25	-	49	45	40	34	28	21	50	47	41	36	32	28	51	50	43	38	36	34	51	51	44	40	39	39	
		100	47	0.01	1	-	40	36	30	22	-	-	40	36	29	21	-	-	41	36	30	23	18	-	41	37	32	27	25	-	42	37	34	31	31	-	42	37	35	34	36	
	8	400	189	0.02	4	63	58	52	47	42	36	60	56	49	44	39	32	60	56	49	45	39	33	61	58	50	45	41	37	62	59	50	46	43	40	63	60	51	46	45	42	
		300	142	0.01	2	55	51	44	38	33	26	56	52	46	40	35	28	58	53	46	41	36	30	58	54	47	42	38	33	58	56	48	42	40	37	59	57	48	43	41	39	
		200	94	0.01	2	50	45	41	34	27	19	-	43	39	32	25	-	49	45	39	34	27	20	50	47	41	35	31	27	51	50	42	37	35	33	51	51	43	39	38	38	
		100	47	0.01	2	-	40	36	30	22	-	-	39	36	29	21	-	-	41	36	30	23	18	-	41	36	31	26	24	-	41	37	33	30	30	-	42	37	34	33	35	
	2	6	550	260	0.21	52	57	51	48	43	35	28	56	50	48	43	34	27	57	51	49	45	37	32	60	54	50	48	43	40	62	57	52	51	50	48	64	59	53	53	55	53
			400	189	0.08	20	53	48	45	40	32	26	51	47	45	40	30	22	55	48	46	44	38	32	57	51	48	48	45	41	59	54	50	52	52	50	60	56	51	55	57	56
			275	130	0.01	2	49	45	43	38	30	23	49	45	43	36	28	20	53	47	44	44	42	33	55	49	45	46	48	43	56	51	47	49	54	54	57	52	48	51	58	62
			800	378	0.11	27	65	58	54	51	42	36	64	56	52	48	41	35	63	56	52	48	42	37	65	59	54	51	46	42	66	61	55	54	51	47	67	63	56	55	53	51
8		700	330	0.08	19	62	55	52	48	39	33	61	54	51	46	38	33	61	54	52	47	40	36	63	57	53	50	45	41	65	60	55	53	49	47	66	62	56	54	53	51	
		550	260	0.04	10	57	51	48	43	35	28	56	50	47	42	33	27	57	51	48	44	36	32	60	54	50	47	43	39	62	57	52	51	49	47	64	59	53	53	54	52	
		400	189	0.02	4	53	48	45	40	32	26	51	47	44	39	30	22	55	48	45	43	38	31	57	51	47	47	44	40	59	54	49	51	51	48	60	56	51	54	56	55	
		275	130	0.01	2	49	45	43	38	30	23	48	44	42	36	27	20	53	46	43	43	41	32	54	48	45	45	47	42	56	51	46	48	53	53	57	52	48	50	57	60	
10		800	378	0.03	7	65	58	54	51	42	36	64	56	52	48	41	35	63	56	52	48	42	37	65	59	54	51	46	42	66	61	55	53	50	47	67	63	56	55	53	51	
		700	330	0.02	4	62	55	52	48	39	33	61	54	50	46	38	32	61	54	51	47	40	35	63	57	53	50	45	41	65	60	54	52	49	46	66	62	55	54	52	50	
		550	260	0.01	2	57	51	48	43	35	28	56	50	47	42	33	26	57	51	48	44	36	31	60	54	50	47	43	39	62	57	51	50	49	46	64	59	52	52	54	51	
		400	189	0.01	2	53	48	45	40	32	26	51	47	44	38	29	21	55	48	45	42	37	30	57	51	47	46	44	39	59	54	49	50	50	47	60	56	50	53	55	53	
275	130	0.01	2	49	45	43	38	30	23	48	44	42	35	26	19	52	46	43	42	40	31	54	48	45	45	46	41	55	50	46	47	51	51	56	51	47	49	55	58			
3	6	550	260	0.22	55	59	52	50	44	34	26	60	52	49	44	35	27	60	52	49	45	37	33	61	55	50	47	40	38	63	58	52	48	43	43	63	60	53	49	45	46	
		400	189	0.09	22	53	46	43	37	27	-	51	45	43	37	27	-	53	47	43	39	33	27	55	50	45	41	37	33	57	54	47	44	41	39	59	56	49	46	44	43	
		1100	519	0.15	37	67	61	57	57	48	39	68	63	56	52	45	38	69	63	56	52	45	39	70	63	57	54	46	42	70	64	58	55	47	46	66	62	55	54	48	48	
		900	425	0.09	22	64	58	55	53	41	34	67	58	53	49	41	35	67	58	53	49	42	37	67	60	54	50	43	40	68	61	55	51	44	43	68	62	56	52	45	46	
	8	650	307	0.04	10	59	52	50	44	34	26	60	52	48	43	34	27	60	52	48	44	36	32	61	55	50	46	39	37	63	58	51	47	42	41	63	60	52	48	44	45	
		400	189	0.01	2	53	46	43	37	27	-	51	45	42	36	26	-	53	47	43	38	32	26	55	50	45	40	36	32	57	53	47	43	40	38	58	55	48	45	43	42	
		1150	543	0.05	12	68	62	58	58	50	41	69	62	56	52	45	39	69	63	56	52	45	40	69	63	57	53	46	42	70	64	58	54	47	45	70	65	58	55	47	47	
		1100	519	0.05	12	67	61	57	57	48	39	68	63	56	52	44	37	69	63	56	52	45	39	69	63	57	53	46	42	70	64	58	54	47	45	70	64	58	55	48	47	
	10	900	425	0.04	9	64	58	55	53	41	34	67	58	52	49	41	35	67	58	53	49	41	36	67	60	54	50	42	39	68	61	55	50	43	43	68	62	55	51	44	45	
		650	307	0.02	4	59	52	50	44	34	26	60	52	48	43	33	26	60	52	48	43	35	31	61	55	49	45	38	35	63	58	51	46	41	40	63	60	52	47	43	44	
		400	189	0.01	1	53	46	43	37	27	-	50	44	42	35	25	-	52	46	43	37	31	25	54	49	44	40	35	31	56	53	46	42	39	37	58	55	48	44	41	41	
		1950	920	0.20	50	72	64	57	54	49	44	73	65	57	54	48	42	73	65	58	54	49	44	74	66	59	55	52	49	75	68	60	56	54	54	76	68	61	57	56	57	
4	10	1800	849	0.17	42	70	62	56	52	47	42	72	63	56	52	46	40	72	63	57	53	48	43	73	65	58	54	51	48	74	67	59	56	53	53	75	68	60	57	55	57	
		1450	684	0.12	29	67	58	53	49	43	36	68	59	53	48	41	35	69	60	54	49	44	40	70	62	56	51	48	46	71	64	58	53	52</								

Performance Data • AHRI Certification and Performance Notes

Model Series 37SST Stealth™ • Low Profile • Series Flow • AHRI Certification Rating Points
Fiberglass Liner

Unit Size	Inlet Size	Fan Airflow		Fan ^Σ Watts	Fan Only* @ .25" w.g. (62 Pa) ΔPs												Primary Airflow	Min. Inlet ΔPs	Fan + 100% Primary @ 1.5" w.g. (375 Pa) ΔPs w/ .25" w.g. (62 Pa) Discharge ΔPs							
					Discharge						Radiated								Radiated							
		cfm	l/s		2	3	4	5	6	7	2	3	4	5	6	7	cfm		l/s	"w.g.	Pa	2	3	4	5	6
1	8	400	189	140	72	67	62	58	54	50	63	58	52	47	42	36	400	189	0.02	4	62	59	50	46	43	40
2	10	800	378	170	70	69	66	64	61	58	65	58	54	51	42	36	800	378	0.03	7	66	61	55	53	50	47
3	10	1100	519	400	76	74	68	68	66	63	67	61	57	57	48	39	1100	519	0.05	12	70	64	58	54	47	45
4	14 x 10	1800	849	600	77	73	72	72	70	67	70	62	56	52	47	42	1800	849	0.12	30	74	67	59	55	53	53

^Σ Motor = ECM.

* Primary air valve is closed and therefore primary cfm is zero.



Ratings are certified in accordance with AHRI Standards.

Performance Notes for Sound Power Levels:

- Discharge (external) static pressure is 0.25" w.g. (63 Pa) in all cases, which is the difference (ΔPs) in static pressure from terminal discharge to the room.
Discharge Sound Power Levels (SWL) now include duct end reflection energy as part of the standard rating. Including the duct end correction provides sound power levels that would normally be transmitted into an acoustically, non-reflective duct. The effect of including the energy correction to the discharge SWL, is higher sound power levels when compared to previous AHRI certified data. For more information on duct end reflection calculations see AHRI Standard 880.
- Radiated sound power is the breakout noise transmitted through the unit casing walls.
- Sound power levels are in decibels, dB re 10⁻¹² watts.
- All sound data listed by octave bands is raw data without any corrections for room absorption or duct attenuation. Dash (-) in space indicates sound power level is less than 20 dB or equal to background.
- Min. inlet ΔPs is the minimum operating pressure of the primary air valve section.
- Asterisk (*) in space indicates that the minimum inlet static pressure requirement is greater than 0.5" w.g. (125 Pa) at rated airflow.
- Data derived from independent tests conducted in accordance with ANSI / ASHRAE Standard 130 and AHRI Standard 880.

FAN POWERED TERMINAL UNITS

Performance Data • Hot Water Coil

Models: 37SW and 37SWST • Low Profile • Series Flow

Unit Size 1

1 Row (single circuit)

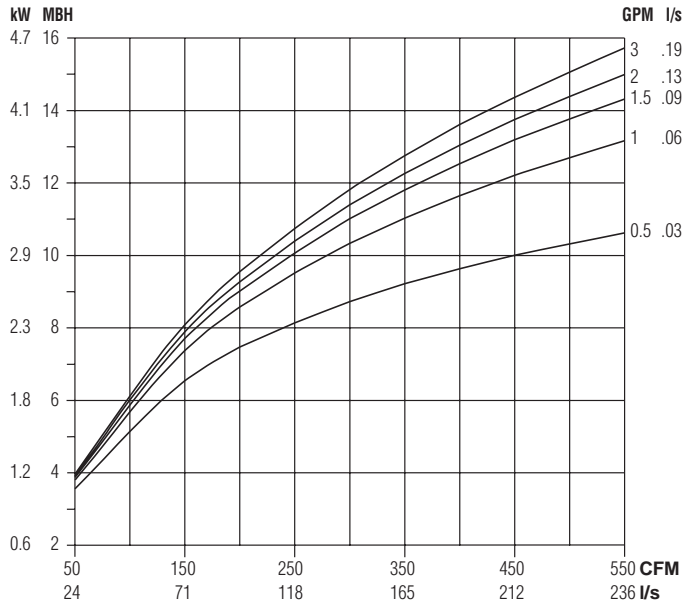

2 Row (multi-circuit)

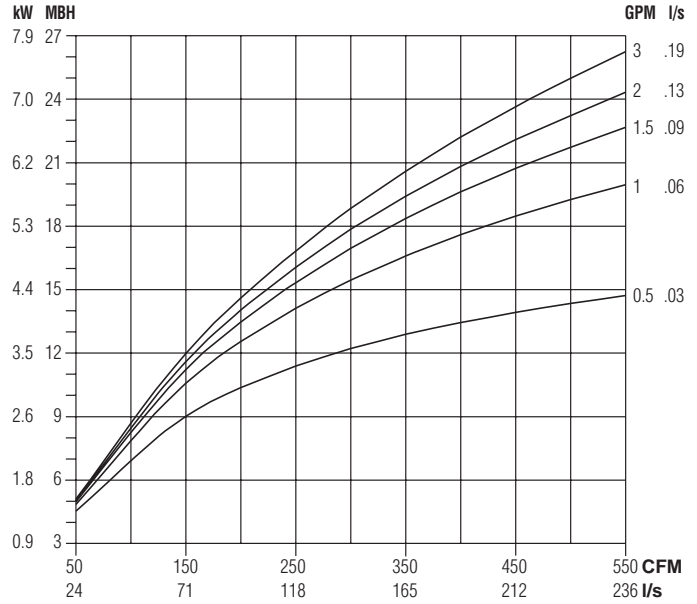

3 Row (multi-circuit)

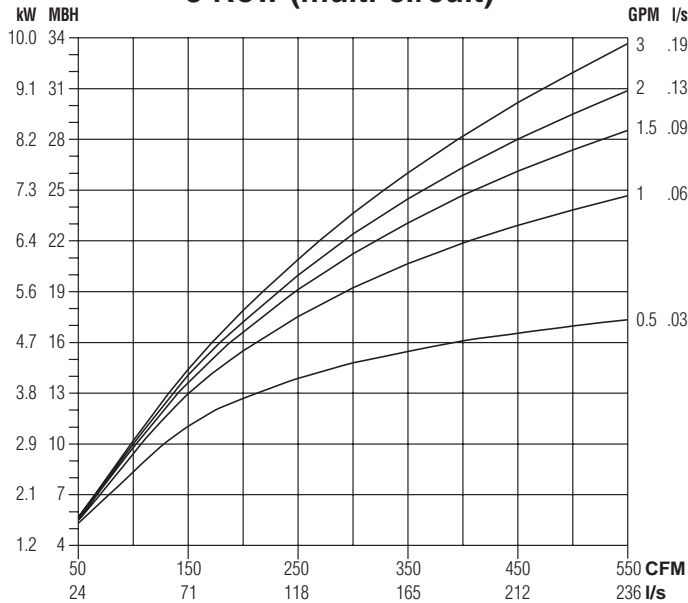

Water Pressure Drop

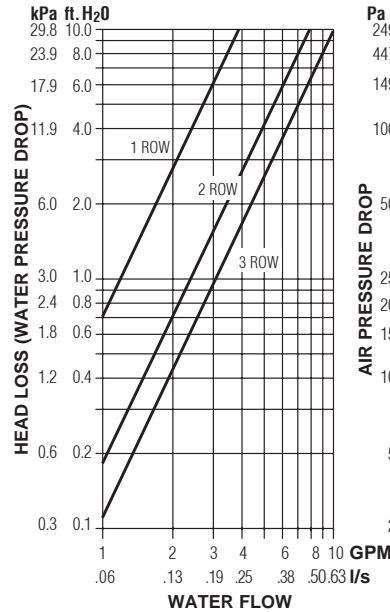

Air Pressure Drop

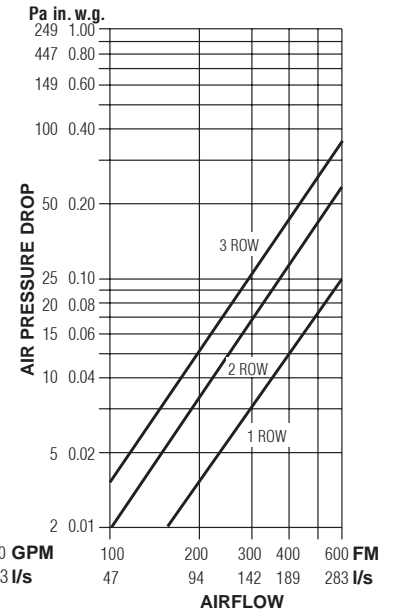

NOTES:

- Capacities are in MBH (kW), **thousands of Btu per hour (kiloWatts)**.
- MBH (kW) values are based on a Δt (temperature difference) of 110°F (61°C) between entering air and entering water. For other Δt 's; multiply the MBH (kW) values by the factors below.

- Air Temperature Rise.

$$\text{ATR (°F)} = 927 \times \frac{\text{MBH}}{\text{cfm}}, \quad \text{ATR (°C)} = 829 \times \frac{\text{kW}}{\text{l/s}}$$

- Water Temp. Drop.

$$\text{WTD (°F)} = 2.04 \times \frac{\text{MBH}}{\text{GPM}}, \quad \text{WTD (°C)} = .224 \times \frac{\text{kW}}{\text{l/s}}$$

- Connections: 1 Row 1/2" (13), 2 and 3 Row 7/8" (22); O.D. male solder.

Altitude Correction Factors:

Altitude ft. (m)	Sensible Heat Factor
0 (0)	1.00
2000 (610)	0.94
3000 (914)	0.90
4000 (1219)	0.87
5000 (1524)	0.84
6000 (1829)	0.81
7000 (2134)	0.78

Correction factors at other entering conditions:

Δt °F (°C)	50 (28)	60 (33)	70 (39)	80 (44)	90 (50)	100 (56)	110 (61)	120 (67)	130 (72)	140 (78)	150 (83)
Factor	.455 (.459)	.545 (.541)	.636 (.639)	.727 (.721)	.818 (.820)	.909 (.918)	1.00 (1.00)	1.09 (1.10)	1.18 (1.18)	1.27 (1.28)	1.36 (1.36)

Performance Data • Hot Water Coil

Models: 37SW and 37SWST • Low Profile • Series Flow

Unit Sizes 2 & 3

1 Row (single circuit)

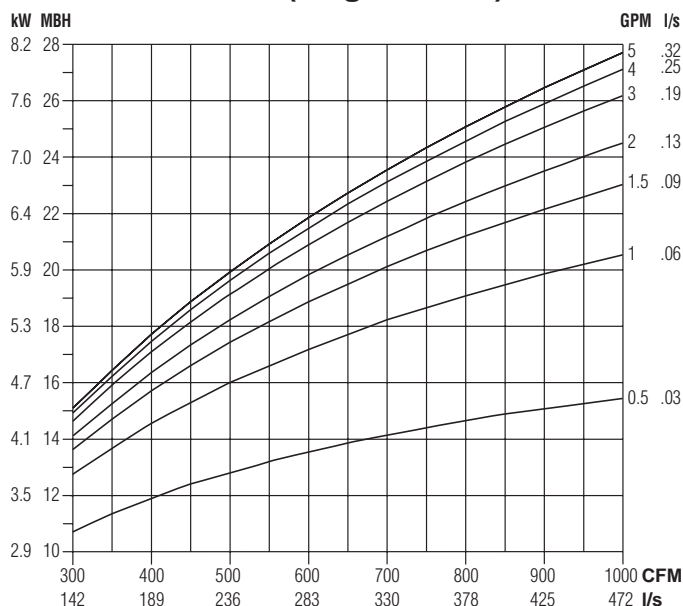

2 Row (multi-circuit)

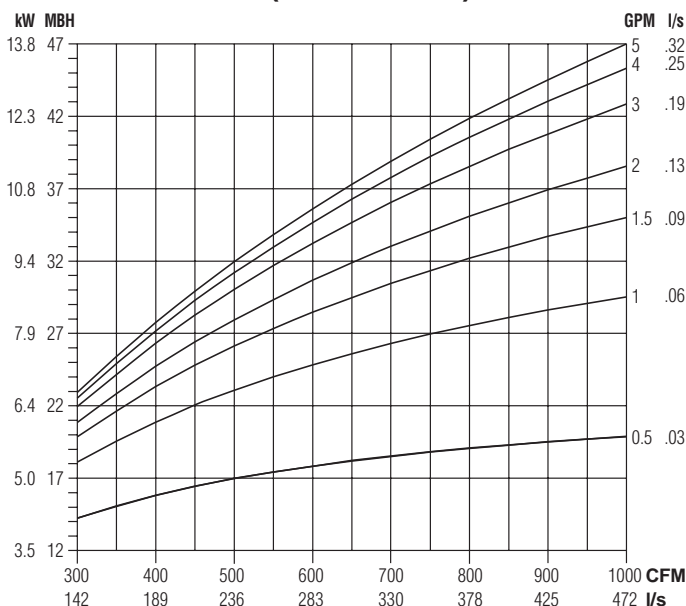

3 Row (multi-circuit)

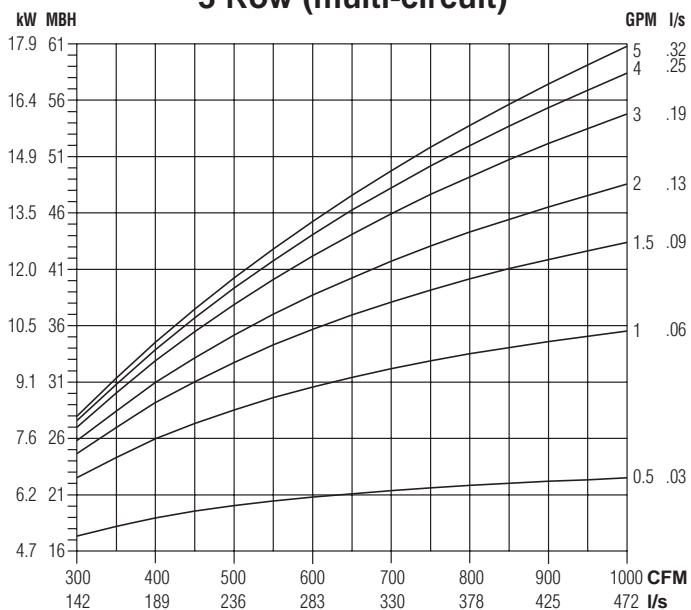

Water Pressure Drop

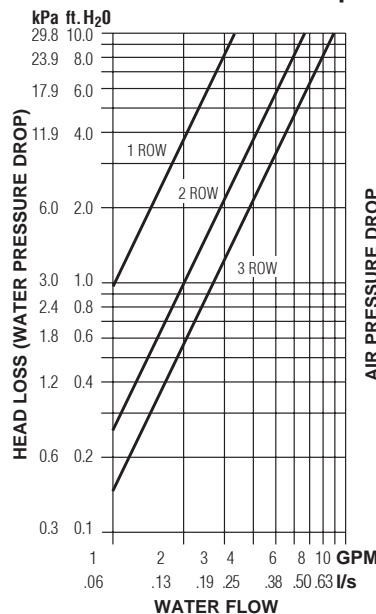

Air Pressure Drop

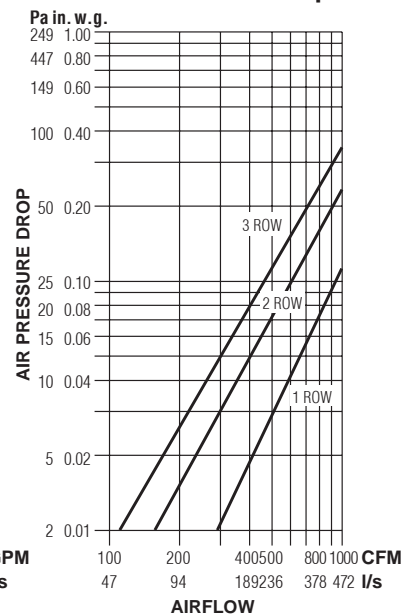

NOTES:

- Capacities are in MBH (kW), **thousands of Btu per hour (kiloWatts)**.
- MBH (kW) values are based on a Δt (temperature difference) of 110°F (61°C) between entering air and entering water. For other Δt 's; multiply the MBH (kW) values by the factors below.

- Air Temperature Rise.

$$\text{ATR (°F)} = 927 \times \frac{\text{MBH}}{\text{cfm}}, \quad \text{ATR (°C)} = 829 \times \frac{\text{kW}}{\text{l/s}}$$

- Water Temp. Drop.

$$\text{WTD (°F)} = 2.04 \times \frac{\text{MBH}}{\text{GPM}}, \quad \text{WTD (°C)} = .224 \times \frac{\text{kW}}{\text{l/s}}$$

- Connections: 1 Row 1/2" (13), 2 and 3 Row 7/8" (22); O.D. male solder.

Altitude Correction Factors:

Altitude ft. (m)	Sensible Heat Factor
0 (0)	1.00
2000 (610)	0.94
3000 (914)	0.90
4000 (1219)	0.87
5000 (1524)	0.84
6000 (1829)	0.81
7000 (2134)	0.78

Correction factors at other entering conditions:

Δt °F (°C)	50 (28)	60 (33)	70 (39)	80 (44)	90 (50)	100 (56)	110 (61)	120 (67)	130 (72)	140 (78)	150 (83)
Factor	.455 (.459)	.545 (.541)	.636 (.639)	.727 (.721)	.818 (.820)	.909 (.918)	1.00 (1.00)	1.09 (1.10)	1.18 (1.18)	1.27 (1.28)	1.36 (1.36)

Performance Data • Hot Water Coil

Models: 37SW and 37SWST • Low Profile • Series Flow

Unit Size 4

1 Row (single circuit)

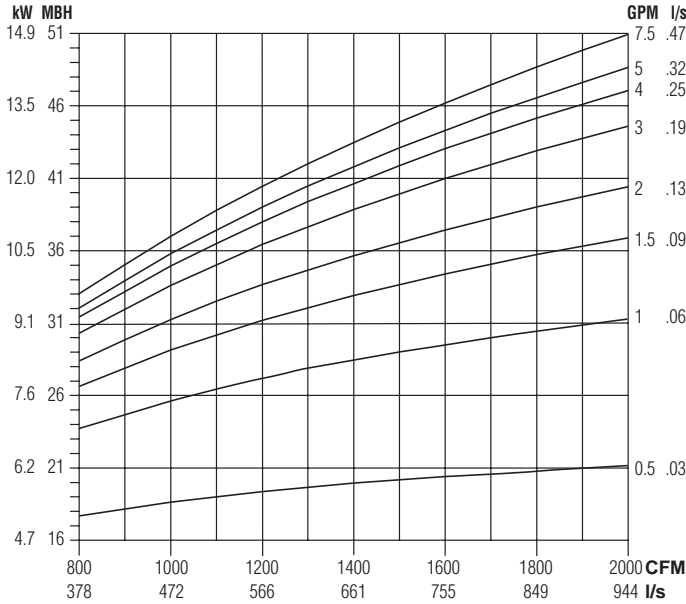

2 Row (multi-circuit)

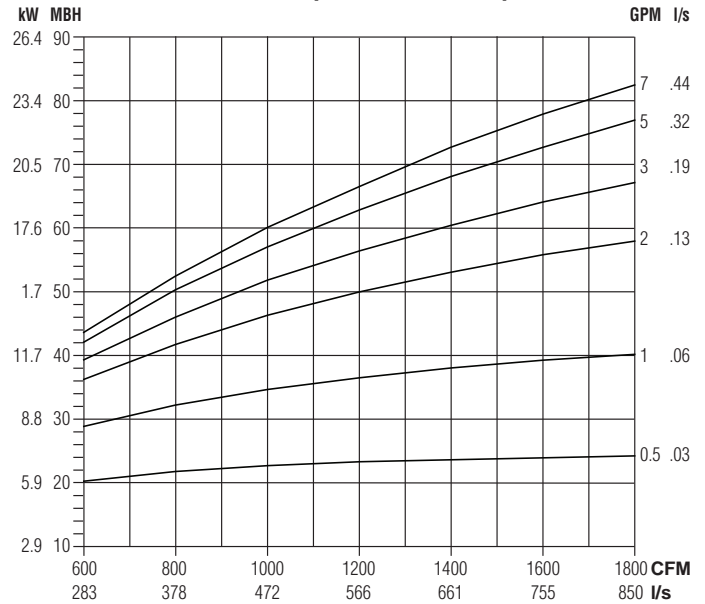

3 Row (multi-circuit)

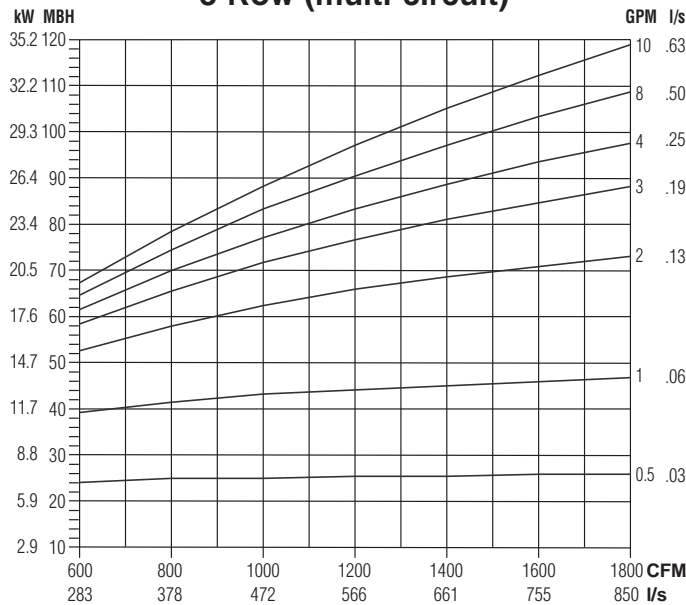

Water Pressure Drop

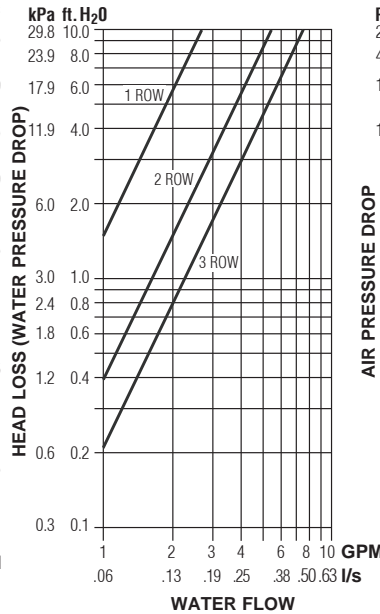

Air Pressure Drop

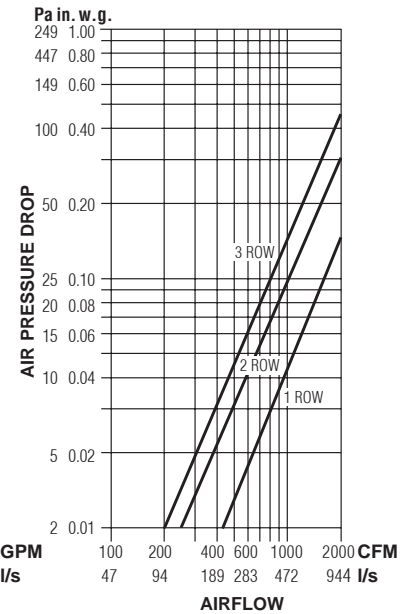

NOTES:

1. Capacities are in MBH (kW), *thousands of Btu per hour (kiloWatts)*.

2. MBH (kW) values are based on a Δt (temperature difference) of 110°F (61°C) between entering air and entering water. For other Δt 's; multiply the MBH (kW) values by the factors below.

3. Air Temperature Rise.

$$\text{ATR (}^\circ\text{F)} = 927 \times \frac{\text{MBH}}{\text{cfm}}, \text{ ATR (}^\circ\text{C)} = 829 \times \frac{\text{kW}}{\text{l/s}}$$

4. Water Temp. Drop.

$$\text{WTD (}^\circ\text{F)} = 2.04 \times \frac{\text{MBH}}{\text{GPM}}, \text{ WTD (}^\circ\text{C)} = .224 \times \frac{\text{kW}}{\text{l/s}}$$

5. Connections: 1 Row 1/2" (13), 2 and 3 Row 7/8" (22); O.D. male solder.

Altitude Correction Factors:

Altitude ft. (m)	Sensible Heat Factor
0 (0)	1.00
2000 (610)	0.94
3000 (914)	0.90
4000 (1219)	0.87
5000 (1524)	0.84
6000 (1829)	0.81
7000 (2134)	0.78

Correction factors at other entering conditions:

Δt °F (°C)	50 (28)	60 (33)	70 (39)	80 (44)	90 (50)	100 (56)	110 (61)	120 (67)	130 (72)	140 (78)	150 (83)
Factor	.455 (.459)	.545 (.541)	.636 (.639)	.727 (.721)	.818 (.820)	.909 (.918)	1.00 (1.00)	1.09 (1.10)	1.18 (1.18)	1.27 (1.28)	1.36 (1.36)

PARALLEL FLOW VARIABLE VOLUME

35N SERIES

Models:

35N No Heat

35NE Electric Heat

35NW Hot Water Heat



Model 35NW

The **35N Series** provides many standard design features and excellent sound performance when compared with other designs. The 35N offers a compact and economical design that provides excellent performance in the most demanding variable air volume/intermittent fan applications. The fan is mounted at ninety degrees to the primary airflow to provide optimum mixing.

STANDARD FEATURES:

- 20 ga. (1.0) galvanized steel construction.
- Round laminated 2 x 20 ga. (1.0) butterfly primary air damper with peripheral gasket. 90° rotation, CW to close. 1/2" (13) dia. plated steel drive shaft. An indicator mark on the end of the shaft shows damper-position. Damper leakage is less than 2% of nominal flow at 3" w.g. (750 Pa).
- Round minimum 6" (152) deep inlet collars for field duct connection.
- Pressure independent primary airflow control (also available in pressure dependent configuration).
- Multi-point averaging Diamond Flow sensor (pressure independent control only).
- Access panels on underside of terminal for ease of maintenance and service.
- Energy efficient PSC fan motor with thermal overload protection.
- Motor blower assembly mounted on special 16 ga. (1.61) angles and isolated from casing with rubber isolators.
- Adjustable PSC solid state fan speed controller with minimum voltage stop.
- Gasketed backdraft damper mounted on fan discharge restricts primary air escaping through the fan section into the ceiling plenum.

- Hinged door on fan controls enclosure.
- 3/4" (19) dual density insulation. Exposed edges coated to prevent air erosion. Meets requirements of NFPA 90A and UL 181.
- Available with electric or hot water supplementary heat.
- Hot water coils are mounted on discharge of 35NW unit with slip and drive duct connection.
- All controls are mounted on exterior of terminal providing ready access for field adjustment.
- Each terminal factory tested prior to shipment.
- Single point electrical and/or pneumatic main air connection.
- Discharge opening on 35N and 35NE designed for flanged duct connection.
- Full primary air valve low voltage NEMA 1 type enclosure for factory mounted DDC and analog electronic controls.

Controls:

- Nailor EZvav
- Analog electronic and pneumatic controls. Factory supplied, mounted and calibrated.
- Digital controls. Factory mounting and wiring of DDC controls supplied by BAS Controls Contractor.

Options:

- ECM/EPIC Fan Technology®.
- Induced air filter, 1" (25) thick, disposable type.
- Primary air valve enclosure for field mounted controls.
- Toggle disconnect switch units with electric heat, when disconnect is an electric heat option and includes fan).
- Various IAQ linings are available.
- Fan airflow switch for night shutdown.
- Night setback fan/heat cycle (pneumatic and analog).
- Fan unit fusing.
- Hanger brackets.
- Q option induced air attenuator.



Dimensions

Model Series 35N • Parallel Flow

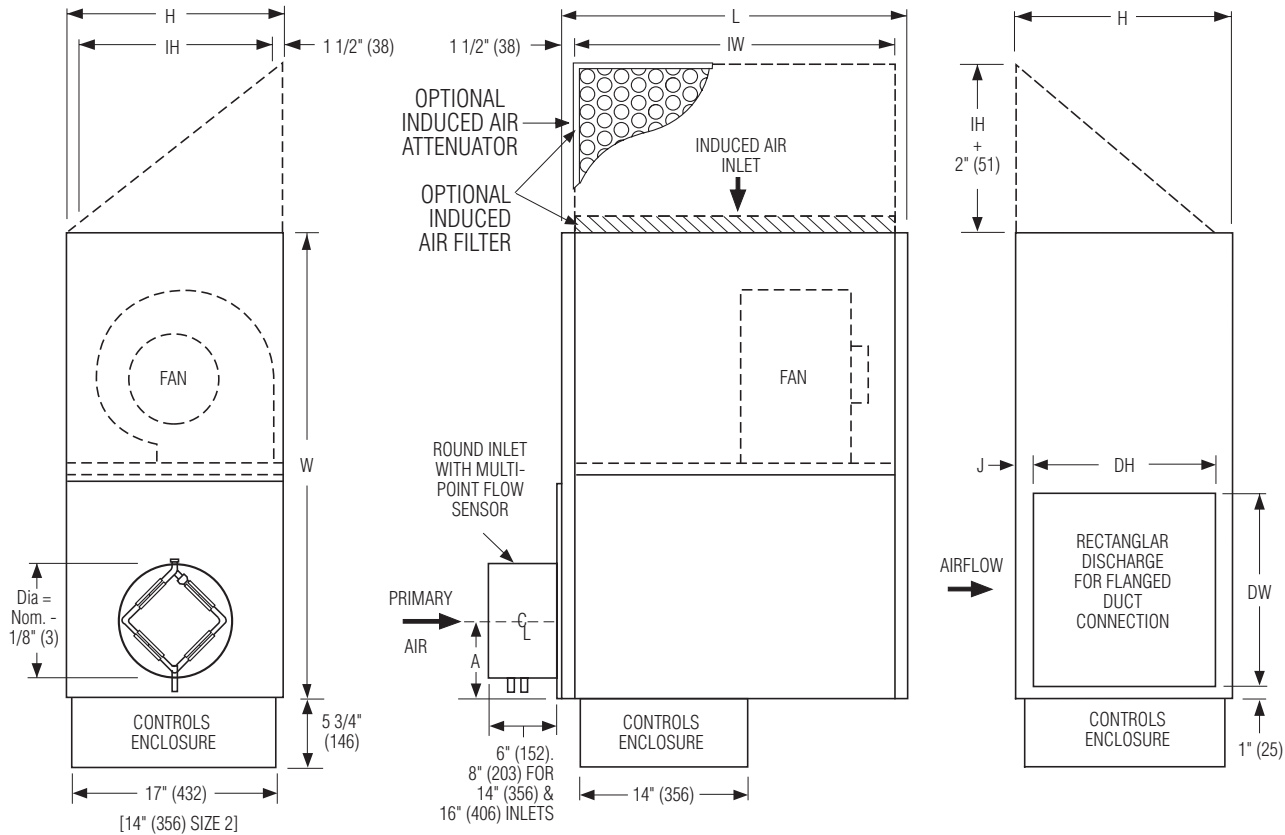

Right hand unit, top view illustrated. Controls mounted as standard on RH side as shown. Left hand units / terminals ordered with LH controls (optional), are built as mirror image. Inlet, discharge and control enclosure are opposite of the drawing.

Dimensional Data

Unit Size	Inlet Size	W	H	L	J	Induced Air Inlet IW x IH	Outlet Discharge DW x DH	Filter Size
2	6, 8, 10, 12 (152, 203, 254, 305)	34 3/4 (883)	14 (356)	27 9/16 (700)	1 (25)	24 9/16 x 10 3/4 (624 x 273)	16 x 12 (406 x 305)	26 x 13 (660 x 330)
3	8, 10, 12, 14 (203, 254, 305, 356)	38 1/4 (972)	18 (457)	28 9/16 (725)	1 1/2 (38)	25 9/16 x 14 3/4 (649 x 375)	16 x 15 (406 x 381)	27 x 17 (686 x 432)
5	10, 12, 14 (254, 305, 356)	45 5/8 (1159)	18 (457)	34 1/2 (876)	1 1/2 (38)	31 1/2 x 14 3/4 (800 x 375)	24 x 15 (610 x 381)	33 x 17 (838 x 432)
6	12, 14, 16 (305, 356, 406)	50 3/4 (1289)	20 (508)	36 (914)	1 1/4 (32)	33 x 16 3/4 (838 x 426)	28 x 17 1/2 (711 x 445)	35 x 19 (889 x 483)

Primary Inlet Dimensions

Inlet Size	Dim. A
6	5 (127)
8	6 (152)
10	7 (178)
12	8 (203)
14	9 (229)
16	10 (254)

Dimensions

Model Series 35N • Parallel Flow

Hot Water Coil Section

Model 35NW

Available in one, two or three row. Coil section installed on unit discharge. Right hand coil connection looking in direction of airflow standard (shown). Left hand is optional (terminals are inverted / built as mirror image). Connections must be selected same hand as controls enclosure location.

Standard Features:

- Coil is mounted on unit discharge.
- 1/2" (13) copper tubes.
- Aluminum ripple fins.
- Sweat Connections:
Size 2 and 3: 1 Row 1/2" (13); O.D. male solder.
All others: 7/8" (22); O.D. male solder.
- Bottom access panel for inspection and coil cleaning.
- Discharge opening for slip and drive connection.

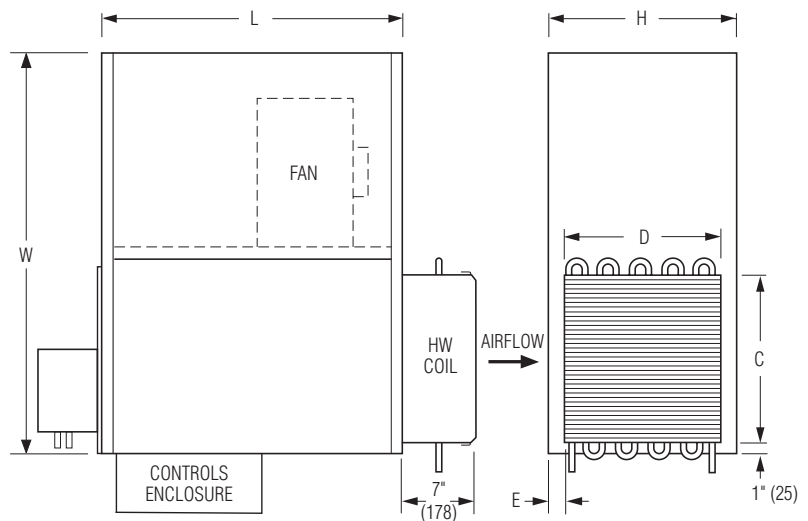

Unit Size	Outlet Duct Size C x D	W	H	L	E
2	16 x 12 1/2 (406 x 318)	34 3/4 (883)	14 (356)	27 9/16 (700)	3/4 (19)
3	16 x 15 (406 x 381)	38 1/4 (972)	18 (457)	28 9/16 (725)	1 1/2 (38)
5	24 x 15 (610 x 381)	45 5/8 (1159)	18 (457)	34 1/2 (876)	1 1/2 (38)
6	28 x 17 1/2 (737 x 445)	50 3/4 (1289)	20 (508)	36 (914)	1 1/4 (32)

Electric Coil Section

Model 35NE

Standard Features:

- Coil installed on unit discharge.
- Insulated coil element wrapper.
- Automatic reset high limit cut-outs (one per element).
- Single point electrical connection for entire terminal unit (except 600V/3 ph., which comes with 120V/1 ph. motor).
- Magnetic contactors per stage.
- Class A 80/20 Ni/Cr wire.
- Positive pressure airflow switch.
- Flanged outlet duct connection.
- Terminal unit with coil is ETL Listed as an assembly.
- Controls mounted as standard on RH side as shown. Terminals ordered with LH controls (optional) are built as mirror image.

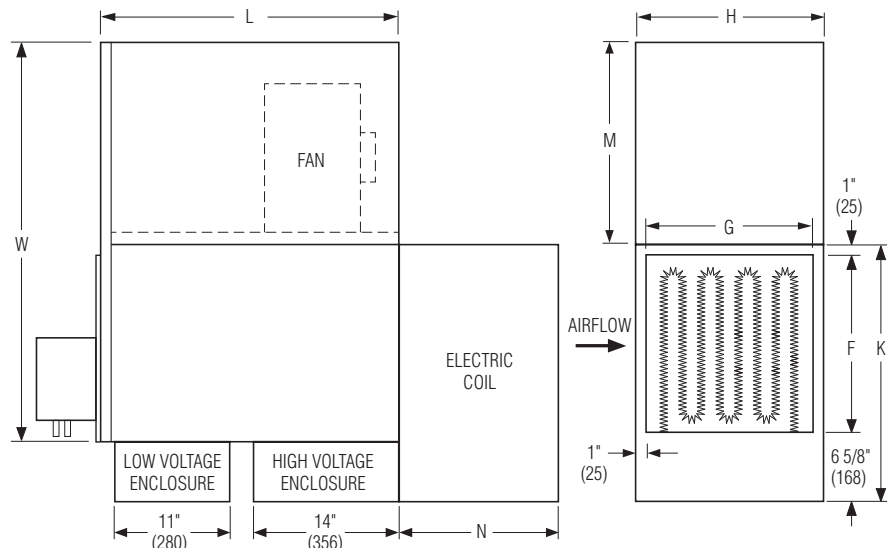

Standard Supply Voltage (60 Hz):

- Single phase: 120, 208, 240 & 277V.
- Three phase: 208, 480 (4 wire wye) and 600V (dual point connection).

Options:

- SCR control.
- SCR control with discharge temperature control.
- Toggle disconnect switch (includes fan).
- Door interlock disconnect switch.
- Mercury contactors.
- Power circuit fusing.
- Dust tight construction.
- Manual reset secondary thermal cut out.

Unit Size	Outlet Duct Size F x G	K	H	M	N
2	17 x 12 (432 x 305)	24 5/8 (626)	14 (356)	15 7/8 (403)	12 1/2 (318)
3	17 x 16 (432 x 406)	24 5/8 (626)	18 (457)	19 3/8 (492)	15 1/4 (387)
5	25 x 16 (635 x 406)	32 5/8 (829)	18 (457)	18 3/4 (476)	15 1/4 (387)
6	29 x 18 (737 x 457)	36 5/8 (930)	20 (508)	19 7/8 (505)	15 1/4 (387)

Performance Data

PSC Motor Fan Curves – Airflow vs. Downstream Static Pressure
35N Series • Parallel Flow

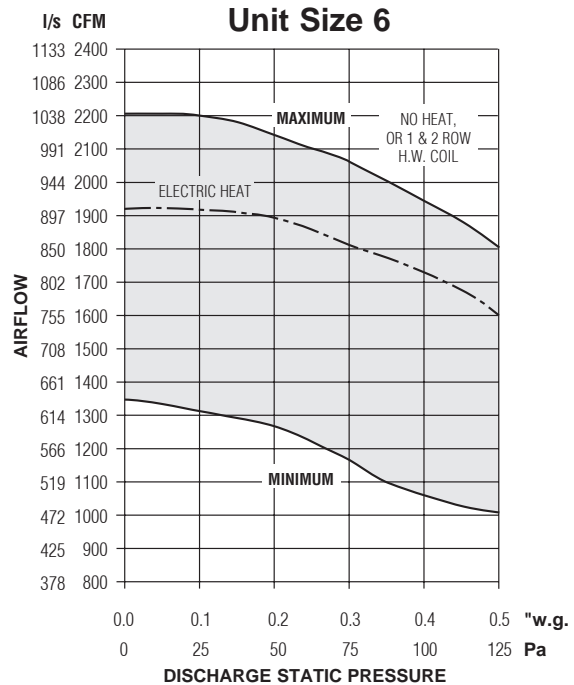
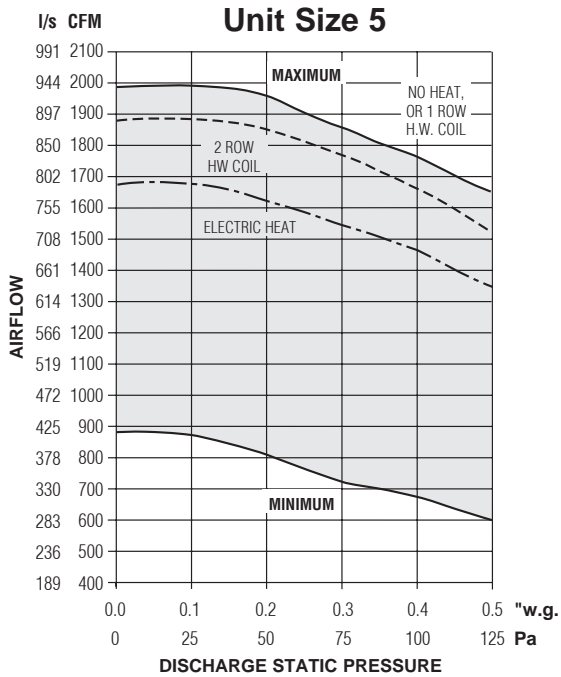
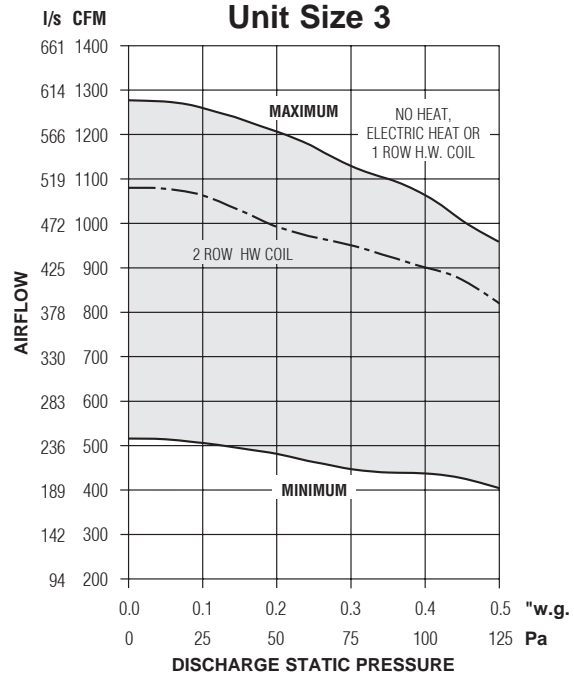
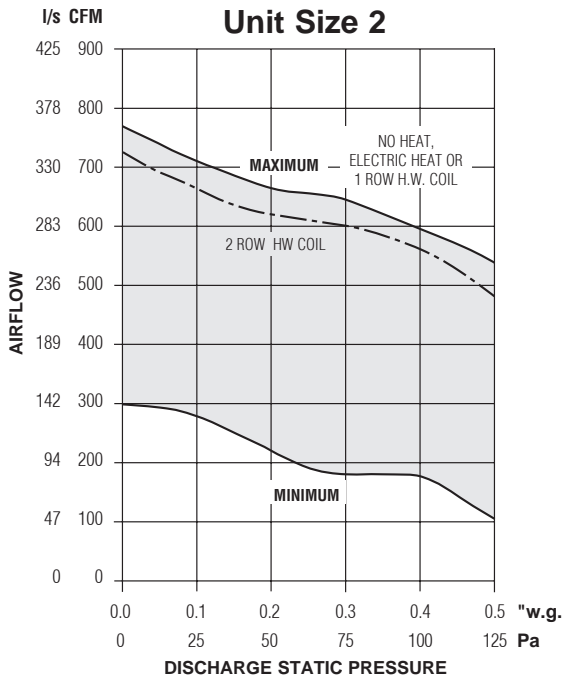

Electrical Data

Unit Size	Motor H.P.	PSC MOTOR FLA			
		120/1/60	208/1/60	240/1/60	277/1/60
2	1/10	2.8	1.4	1.4	1.2
3	1/4	4.7	2.0	2.0	1.7
5	1/2	9.9	4.1	4.1	3.5
6	3/4	8.4	3.8	3.8	3.7

FLA = Full load amperage

- Fan curves shown are applicable to 120, 208, 240 and 277 volt, single phase PSC motors.

Performance Data

ECM Motor Fan Curves – Airflow vs. Downstream Static Pressure

35N Series • Parallel Flow

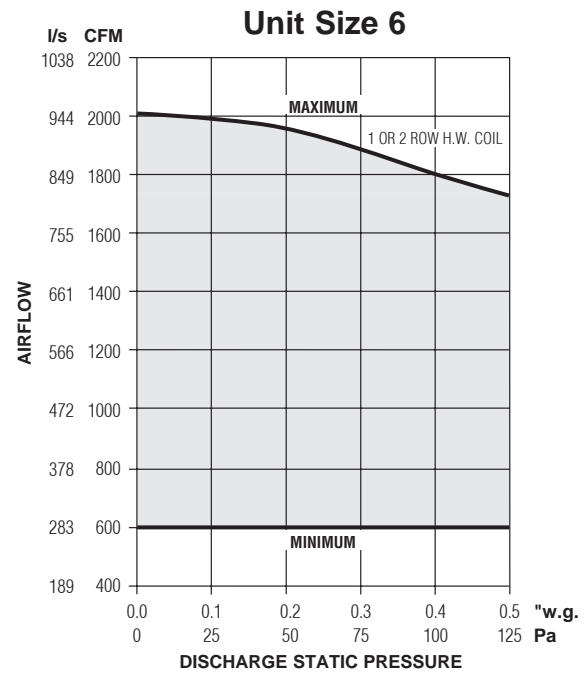
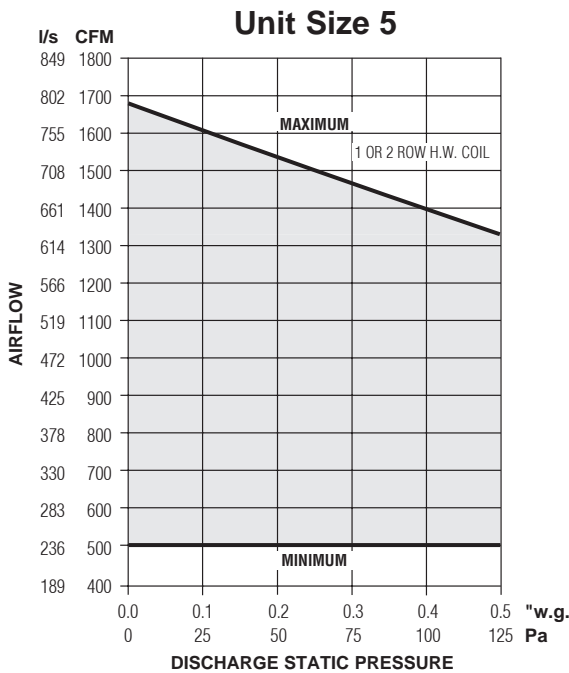
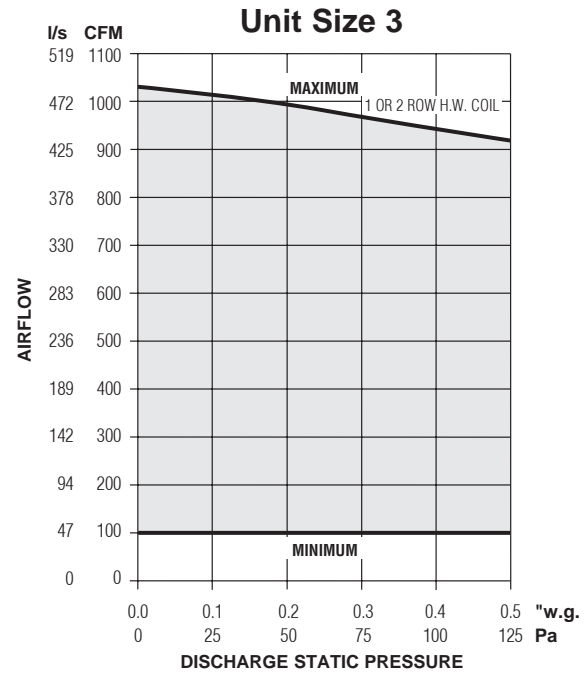
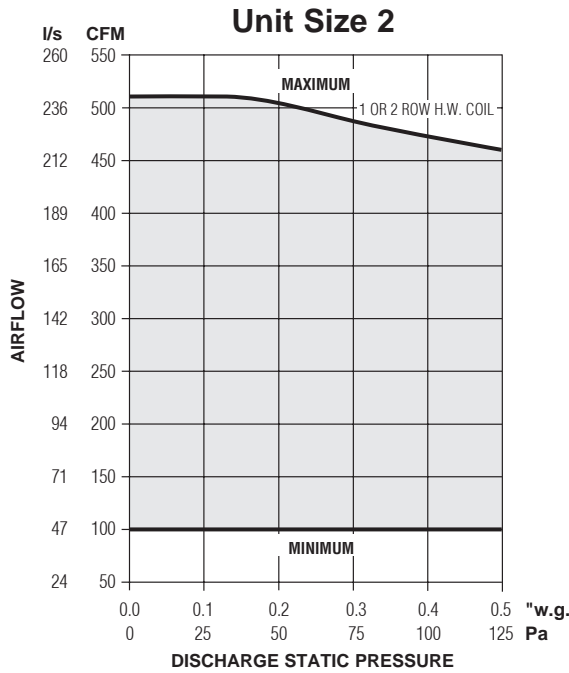

Electrical Data

Unit Size	EPIC ECM Motor FLA				
	Motor HP	120V	208V	240V	277V
2	*	3.9	2.2	2.2	1.8
3	*	6.9	3.9	3.9	3.5
5	*	11.9	6.8	6.8	6.1
6	*	13.7	7.9	7.9	6.7

* The ECM is a variable horsepower motor. Refer to Selectworks Schedule for actual power consumption.
 FLA = Full load amperage.
 All motors are single phase/60 Hz.

NOTES:

- The ECM is pressure independent and constant volume in operation at factory or field set point within the shaded area. Airflow does not vary with changing static pressure conditions. The motor compensates for any changes in external static pressure or induced air conditions such as filter loading.
- Airflow can be set to operate on horizontal performance line at any point within shaded area using the solid state volume controller provided.
- Fan curves shown are applicable to 120/240, 208 and 277 volt, single phase ECM's. ECM's, although DC in operation, include a built-in AC/DC converter.

Performance Data • NC Level Application Guide

Model Series 35N • Parallel Flow • 100% Primary Air • Cooling Cycle

Fiberglass Liner

Unit Size	Inlet Size	Airflow		Min. Inlet ΔPs		NC Levels @ Inlet pressure (ΔPs) shown									
						DISCHARGE					RADIATED				
						Min. ΔPs	0.5" w.g. (125 Pa)	1.0" w.g. (250 Pa)	1.5" w.g. (375 Pa)	2.0" w.g. (500 Pa)	Min. ΔPs	0.5" w.g. (125 Pa)	1.0" w.g. (250 Pa)	1.5" w.g. (375 Pa)	2.0" w.g. (500 Pa)
2	6	500	236	0.49	122	-	-	24	31	36	22	25	32	35	38
		400	189	0.15	37	-	-	24	30	33	20	24	30	33	34
		300	142	0.18	45	-	-	25	29	33	-	23	26	30	32
		200	94	0.08	20	-	-	23	25	26	-	20	23	28	30
		100	47	0.02	5	-	-	-	-	-	-	-	22	26	29
	8	875	413	0.30	75	-	-	25	30	36	-	-	29	31	35
		700	330	0.20	50	-	-	24	31	33	-	-	26	32	34
		525	248	0.11	27	-	-	23	29	33	-	-	23	30	32
		350	165	0.05	12	-	-	20	24	26	-	-	20	26	31
		175	83	0.01	2	-	-	-	-	27	-	-	22	26	28
	10	1375	649	0.40	99	-	-	25	33	36	21	24	29	34	37
		1100	519	0.24	60	-	-	24	30	33	-	20	26	33	36
		825	389	0.15	37	-	-	21	26	30	-	-	25	30	34
		550	260	0.06	15	-	-	20	21	23	-	-	23	26	30
		275	130	0.02	5	-	-	-	-	28	-	-	20	24	26
	12	2000	944	0.45	112	-	-	25	33	36	32	32	35	35	37
		1600	755	0.30	75	-	-	25	31	34	26	29	28	31	34
		1200	566	0.18	45	-	-	24	28	30	-	-	24	29	32
		800	378	0.08	20	-	-	-	24	24	-	-	20	22	25
		400	189	0.02	5	-	-	-	-	27	-	-	-	21	24
3	8	875	413	0.24	60	-	-	26	31	34	20	21	30	33	36
		700	330	0.15	37	-	-	24	30	31	-	20	28	33	34
		525	248	0.08	20	-	-	23	26	30	-	-	22	26	30
		350	165	0.04	10	-	-	-	24	23	-	-	-	23	28
		175	83	0.01	2	-	-	-	-	26	-	-	-	20	23
	10	1375	649	0.25	62	-	-	28	34	37	26	30	33	36	39
		1100	519	0.16	40	-	-	25	31	35	-	26	29	34	36
		825	389	0.09	22	-	-	23	29	31	-	22	26	30	32
		550	260	0.04	10	-	-	20	25	29	-	-	22	26	29
		275	130	0.01	2	-	-	-	-	22	-	-	21	22	23
	12	2000	944	0.34	85	-	-	28	31	36	-	23	29	33	36
		1600	755	0.22	55	-	-	24	31	34	-	-	25	33	35
		1200	566	0.12	30	-	-	23	28	29	-	-	25	29	33
		800	378	0.05	12	-	-	-	22	21	-	-	21	24	26
		400	189	0.01	2	-	-	-	20	29	-	-	-	20	23
14	2625	1239	0.39	97	21	21	28	33	36	22	23	30	33	37	
	2100	991	0.25	62	-	-	25	30	33	-	20	28	31	34	
	1575	743	0.14	35	-	-	21	26	29	-	-	22	29	32	
	1050	495	0.06	15	-	-	-	22	23	-	-	21	26	29	
	525	248	0.02	5	-	-	-	20	28	-	-	-	23	24	
5	10	1375	649	0.26	65	-	-	28	31	35	-	22	26	33	35
		1100	519	0.17	42	-	-	24	29	31	-	24	26	31	34
		825	389	0.11	27	-	-	21	26	29	-	-	23	26	29
		550	260	0.04	10	-	-	20	24	28	-	-	-	25	26
		275	130	0.01	2	-	-	-	-	28	-	-	-	-	21
	12	2000	944	0.24	60	-	-	26	33	35	23	26	35	36	39
		1600	755	0.15	37	-	-	25	30	33	20	26	31	34	36
		1200	566	0.08	20	-	-	21	26	26	-	23	26	30	33
		800	378	0.03	7	-	-	-	21	24	-	20	22	25	28
		400	189	0.01	2	-	-	-	-	21	-	-	21	23	23
	14	2625	1239	0.30	75	-	-	25	30	33	20	22	28	31	34
		2100	991	0.19	47	-	-	23	26	28	-	-	25	28	31
		1575	743	0.10	25	-	-	-	23	24	-	-	22	25	28
		1050	495	0.04	10	-	-	-	21	22	-	-	-	22	25
		525	248	0.01	2	-	-	-	20	28	-	-	-	-	23
6	12	2000	944	0.21	52	-	-	25	30	33	-	20	29	33	35
		1600	755	0.13	32	-	-	23	29	29	-	-	28	30	30
		1200	566	0.07	17	-	-	20	24	24	-	20	21	24	29
		800	378	0.04	10	-	-	-	21	22	-	-	-	21	24
		400	189	0.01	2	-	-	-	-	28	-	-	-	-	20
	14	2625	1239	0.22	55	-	23	29	34	37	28	35	39	40	41
		2100	991	0.14	35	-	-	26	31	35	22	31	35	36	38
		1575	743	0.07	17	-	-	24	30	30	-	26	30	33	34
		1050	495	0.03	7	-	-	20	25	28	-	22	25	28	29
		525	248	0.01	2	-	-	-	22	25	-	-	20	22	24
	16	3425	1616	0.25	62	25	25	28	30	34	25	26	30	31	35
		2750	1298	0.16	40	-	-	23	29	29	-	23	25	29	31
		2050	967	0.08	20	-	-	20	25	26	-	-	23	26	28
		1375	649	0.04	10	-	-	-	23	26	-	22	20	22	24
		700	330	0.01	2	-	-	-	22	26	-	-	-	-	21

Performance Notes:

1. NC Levels are calculated based on procedures as outlined on page C160.
2. Dash (-) in space indicates a NC less than 20.

Performance Data • Discharge Sound Power Levels

Model Series 35N • Parallel Flow • 100% Primary Air • Cooling Cycle

Fiberglass Liner



Unit Size	Inlet Size	Airflow		Min. inlet ΔPs "w.g. Pa	100% Primary Air – Sound Power Octave Bands @ Inlet pressure (ΔPs) shown																																		
					Minimum ΔPs							0.5" w.g. (125Pa) ΔPs							1.0" w.g. (249Pa) ΔPs							1.5" w.g. (375Pa) ΔPs							2.0" w.g. (500Pa) ΔPs						
					2	3	4	5	6	7	2	3	4	5	6	7	2	3	4	5	6	7	2	3	4	5	6	7	2	3	4	5	6	7					
2	6	500	236	0.45	133	61	57	52	49	46	47	62	58	53	50	47	48	69	65	59	55	52	54	72	71	64	58	55	58	74	75	69	60	57	61				
		400	189	0.15	37	57	52	48	45	41	40	61	56	51	48	45	44	67	65	58	53	50	51	72	70	63	56	54	57	72	72	67	58	56	60				
		300	142	0.17	42	52	46	43	40	34	30	61	57	50	47	44	43	66	65	57	51	50	51	67	68	62	55	53	56	69	71	66	57	55	59				
		200	94	0.08	19	-	42	37	30	20	-	59	56	49	45	43	43	62	63	56	50	49	50	63	65	60	54	52	54	63	66	64	57	54	57				
		100	47	0.01	3	-	-	-	-	-	-	50	53	48	44	40	38	53	57	56	50	44	43	52	56	60	54	47	47	52	57	61	57	50	50				
	8	875	413	0.30	75	56	54	50	48	45	45	62	60	54	52	49	49	71	67	61	57	53	55	77	71	65	59	56	60	79	76	69	57	57	61				
		700	330	0.20	50	55	51	45	44	40	38	65	60	53	50	48	48	70	66	59	54	52	54	74	72	65	56	56	59	75	73	67	56	57	60				
		525	248	0.11	27	-	44	38	38	32	29	61	57	49	46	45	43	67	64	57	50	51	52	71	69	64	54	55	57	71	72	66	54	56	58				
		350	165	0.05	12	-	38	31	29	20	-	58	54	47	44	43	41	62	62	55	48	50	50	64	65	60	52	54	55	64	67	64	54	54	55				
		175	83	0.01	2	-	-	-	-	-	-	55	52	46	43	42	39	55	59	54	47	48	47	56	57	60	50	53	51	58	59	60	50	59	64				
	10	1375	649	0.40	99	60	58	55	50	50	49	62	61	57	51	51	51	69	67	64	55	55	57	75	73	69	59	58	62	76	76	71	59	58	63				
		1100	519	0.24	60	56	52	50	45	44	41	61	59	56	49	49	48	68	66	62	53	54	55	72	71	67	57	57	61	73	73	67	57	58	62				
		825	389	0.15	37	51	46	43	39	36	32	60	57	53	46	47	45	65	64	59	50	52	53	68	68	65	54	56	62	68	71	68	54	56	59				
		550	260	0.06	15	-	38	34	29	23	-	56	53	48	43	43	40	60	62	57	48	51	51	63	63	62	52	54	57	62	64	64	53	53	56				
		275	130	0.02	5	-	-	-	-	-	-	51	51	47	42	42	38	53	56	55	46	47	47	55	58	61	50	51	52	55	60	63	62	61	65				
	12	2000	944	0.45	112	62	59	55	52	50	51	62	59	55	52	50	51	68	67	63	57	56	58	74	73	67	59	59	62	76	76	71	60	60	64				
		1600	755	0.30	75	57	54	49	46	44	43	61	59	55	50	50	49	69	67	62	54	55	57	72	72	66	58	58	61	73	74	69	58	58	63				
		1200	566	0.18	45	51	45	42	38	35	30	61	57	53	47	46	46	67	66	60	52	54	55	68	69	64	55	57	60	69	71	67	56	56	59				
		800	378	0.08	20	50	39	34	31	26	-	57	53	49	44	45	42	61	61	56	49	51	51	63	66	62	53	55	57	66	66	64	54	53	55				
		400	189	0.02	5	49	35	29	23	-	-	52	50	46	42	42	38	54	57	56	48	48	48	56	59	59	51	51	51	57	60	62	59	58	63				
3	8	875	413	0.24	60	59	55	50	48	46	46	64	59	53	52	49	50	72	68	61	57	55	57	76	72	64	59	57	61	75	74	66	59	58	62				
		700	330	0.15	37	55	50	44	44	41	39	67	58	52	51	49	49	70	66	58	54	53	55	73	71	62	56	56	59	75	72	65	56	57	61				
		525	248	0.08	20	-	41	36	35	31	27	62	57	49	46	46	45	66	64	56	50	52	53	68	67	60	53	54	57	68	70	63	54	56	58				
		350	165	0.04	10	-	-	28	25	-	-	57	52	44	42	43	41	62	61	53	47	50	51	64	65	58	51	53	56	64	64	61	53	52	53				
		175	83	0.01	2	-	-	-	-	-	-	52	48	44	40	41	38	54	54	52	46	47	47	55	56	56	49	50	51	55	61	59	59	59	63				
	10	1375	649	0.35	75	66	59	53	50	50	49	67	61	57	52	53	53	71	69	63	57	57	59	74	74	67	59	60	64	76	77	70	61	62	66				
		1100	519	0.16	40	60	53	48	45	44	41	64	59	54	50	50	50	69	67	60	54	56	57	71	72	65	57	59	62	74	75	68	60	61	65				
		825	389	0.10	25	53	47	44	42	37	31	62	57	52	48	47	47	67	65	58	52	55	56	69	70	63	55	58	61	71	72	66	58	60	64				
		550	260	0.04	11	-	42	42	39	33	27	58	54	49	45	49	45	63	62	56	50	53	54	64	66	61	54	57	59	65	69	65	56	59	62				
		275	130	0.01	2	-	39	40	35	26	18	53	53	49	44	45	44	55	58	56	49	51	52	57	60	58	53	55	56	58	62	60	55	57	59				
	12	2000	944	0.34	85	62	59	58	51	50	50	64	62	59	52	52	53	70	69	64	55	57	59	73	72	67	58	59	63	75	76	70	59	60	65				
		1600	755	0.22	55	57	53	52	45	44	41	62	60	56	49	51	50	68	66	61	53	56	57	71	72	65	56	59	62	72	74	69	57	59	64				
		1200	566	0.12	30	50	46	43	37	34	28	59	56	52	45	48	46	66	65	59	51	55	56	67	69	63	54	58	60	68	70	66	54	57	61				
		800	378	0.05	12	-	36	31	24	-	-	56	51	47	42	44	41	60	61	57	49	54	55	61	63	59	51	56	58	63	63	61	53	55	57				
		400	189	0.01	2	-	35	29	20	-	-	49	49	46	41	45	42	52	55	53	47	50	51	56	58	57	50	54	56	54	58	57	62	62	66				
	14	2625	1239	0.39	97	66	64	60	55	52	50	67	64	61	55	54	53	72	69	64	58	58	60	74	73	66	60	60	63	75	76	70	59	61	65				
		2100	991	0.25	62	62	59	54	49	47	43	64	61	56	51	52	50	69	67	61	55	57	58	70	71	64	57	59	62	73	73	68	57	60	63				
		1575	743	0.14	35	55	52	45	40	36	30	60	56	51	47	49	46	66	64	58	52	55	56	68	68	62	55	58	60	69	70	65	56	58	61				
		1050	495	0.06	15	48	41	34	29	22	-	56	52	47	44	47	44	60	60	56	49	53	54	62	64	60	52	56	58	64	65	63	54	56	59				
		525	248	0.02	5	-	-	24	-	-	-	49	49	45	42	44	42	54	57	53	48	51	52	55	59	57	51	53	56	58	62	61	59	60	64				
5	10	1375	649	0.26	65	59	55	55	50	49	49	65	61	59	52	52	53	71	69	64	56	56	59	73	72	66	57	58	61	72	75	70	57	59	63				
		1100	519	0.17	42	53	49	48	43	41	39	62	58	55	48	49	49	69	66	61	52	54	56	71	70	65	56	57	61	72	72	68	56	58	62				
		825	389	0.11	27	50	43	42	36	34	29	61	56	52	45	47	46	66	64	58	50	53	54	67	68	62	53	56	59	69	70	66	54	57	61				
		550	260	0.04	10	-	37	32	27	-	-	58	53	48	43	45	43	63	62	57	49	52	53	63	65	61	51	54	57	66	68	65	53	54	57				
		275	130	0.01	2	-	-	-	-	-	-	51	49	46	40	41	40	53	54	53	45	48	48	55	58	57	50	52	54	56	60	60	61	61	66				
	12	2000	944	0.28	71	63	58	56	51	50	50	67	61	58	53	52	53	71	68	63	56	56	58	74	73	67	58	59	62	76	75	70	60	61	64				
		1600	755	0.15	37	59	53	51	47	45	43	65	59	55	49	45	43	7																					

Performance Data • Radiated Sound Power Levels
 Model Series 35N • Parallel Flow • 100% Primary Air • Cooling Cycle
 Fiberglass Liner

Unit Size	Inlet Size	Airflow		Min. inlet ΔPs		100% Primary Air – Sound Power Octave Bands @ Inlet pressure (ΔPs) shown																																		
						Minimum ΔPs					0.5" w.g. (125Pa) ΔPs					1.0" w.g. (249Pa) ΔPs					1.5" w.g. (375Pa) ΔPs					2.0" w.g. (500Pa) ΔPs														
						2	3	4	5	6	7	2	3	4	5	6	7	2	3	4	5	6	7	2	3	4	5	6	7	2	3	4	5	6	7					
2	6	500	236	0.45	133	54	50	48	42	35	31	58	53	51	45	38	33	65	61	57	49	42	38	67	64	60	51	44	42	69	66	63	52	45	44					
		400	189	0.15	37	-	45	46	40	32	26	57	51	50	44	36	30	64	58	55	47	40	37	66	62	58	48	42	40	66	63	59	49	43	42					
		300	142	0.17	42	-	40	43	38	29	21	56	50	49	43	35	29	61	55	52	44	38	34	62	58	55	45	40	38	63	59	57	46	41	41					
		200	94	0.08	19	-	37	42	36	28	19	53	46	46	40	32	25	55	51	49	42	36	31	56	54	53	42	38	36	56	55	55	44	40	39					
		100	47	0.01	3	-	35	38	34	25	-	48	41	42	33	25	18	48	47	48	37	31	26	49	47	52	39	34	31	49	47	54	42	37	34					
	8	875	413	0.30	75	50	46	41	36	32	29	55	50	45	40	35	32	65	57	52	42	39	38	67	61	56	45	43	42	67	64	59	45	44	44					
		700	330	0.20	50	49	43	37	32	29	24	54	49	43	36	33	29	62	57	51	39	38	36	65	61	57	42	41	41	66	63	59	44	43	43					
		525	248	0.11	27	-	36	31	27	-	-	53	48	41	33	32	29	58	54	49	36	37	35	61	58	55	39	39	39	61	61	57	42	41	41					
		350	165	0.05	12	-	35	28	24	-	-	51	45	39	30	30	26	53	51	46	33	35	33	55	55	52	37	38	37	53	58	56	40	40	40					
		175	83	0.01	2	-	-	-	-	-	-	45	41	36	28	27	22	46	50	48	33	33	31	45	49	52	36	36	33	45	48	53	39	38	36					
	10	1375	649	0.40	99	56	51	47	39	37	36	57	53	50	41	39	38	64	58	54	43	42	43	67	63	58	46	44	47	69	66	61	48	46	49					
		1100	519	0.24	60	51	46	42	34	32	30	54	50	46	36	35	33	61	56	52	40	40	40	64	62	56	43	43	45	66	64	61	46	45	48					
		825	389	0.15	37	46	39	34	28	26	21	53	47	43	33	33	32	59	55	51	37	38	39	59	59	55	41	41	44	61	61	59	44	44	48					
		550	260	0.06	15	-	34	26	-	-	-	51	45	39	30	31	29	53	53	49	35	37	37	54	53	52	39	40	42	56	56	55	42	42	46					
		275	130	0.02	5	-	-	-	-	-	-	45	42	38	28	29	25	47	48	46	34	35	35	47	49	50	37	38	39	47	50	52	41	41	42					
	12	2000	944	0.45	112	62	59	57	49	42	38	62	59	57	49	42	38	68	63	60	49	43	40	69	64	60	49	45	44	69	66	61	50	47	47					
		1600	755	0.30	75	59	55	52	43	35	30	60	57	54	43	36	31	64	58	53	43	41	38	65	61	56	46	44	43	66	63	59	49	47	46					
		1200	566	0.18	45	52	48	45	35	27	-	55	49	44	34	32	26	59	54	50	40	39	35	60	58	54	43	43	42	62	60	57	45	44	45					
		800	378	0.08	20	44	38	33	22	-	-	50	44	38	32	32	26	52	49	46	36	38	35	54	50	48	38	40	41	56	53	51	42	42	46					
		400	189	0.02	5	42	34	26	-	-	-	41	37	34	28	30	21	46	44	44	34	37	34	47	46	47	37	39	41	48	48	50	40	41	48					
3	8	875	413	0.24	60	49	49	46	42	40	38	55	51	47	43	40	38	63	60	55	47	45	45	65	62	57	48	46	47	67	65	60	50	48	50					
		700	330	0.15	37	48	43	41	37	34	31	53	49	46	41	38	36	62	58	52	45	43	42	65	62	57	48	46	47	65	63	59	49	47	49					
		525	248	0.08	20	-	35	32	27	-	-	50	46	41	35	33	30	56	53	48	39	39	38	57	56	52	42	41	42	58	59	55	45	43	46					
		350	165	0.04	10	-	34	23	-	-	-	47	42	36	31	29	27	52	50	45	37	36	36	52	53	49	40	39	40	53	56	53	44	42	44					
		175	83	0.01	2	-	-	-	-	-	-	45	40	36	29	28	25	46	46	45	35	33	33	46	47	46	36	36	36	47	49	49	41	39	41					
	10	1375	649	0.35	75	63	51	48	42	37	32	66	58	53	46	41	37	68	62	57	49	43	40	70	65	60	51	45	44	71	68	62	52	47	46					
		1100	519	0.16	40	57	47	45	39	33	24	63	54	50	44	38	32	65	59	54	46	41	37	67	63	57	48	43	41	69	65	60	50	44	43					
		825	389	0.10	25	-	43	42	37	29	19	59	51	48	41	35	29	62	57	51	43	38	36	65	60	54	44	41	40	66	61	57	45	42	42					
		550	259	0.04	11	-	40	41	35	27	-	55	48	45	39	33	26	58	52	48	39	36	33	59	56	52	41	39	38	61	57	54	43	41	40					
		275	130	0.01	2	-	-	38	34	26	-	50	44	43	36	30	23	51	48	47	37	33	29	53	50	48	40	36	34	52	52	49	41	38	36					
	12	2000	944	0.34	85	53	49	45	40	38	34	54	53	49	43	40	38	60	58	54	45	44	44	64	62	57	48	48	48	65	65	60	50	50	51					
		1600	755	0.22	55	48	44	41	35	32	27	51	49	44	38	36	32	59	56	51	43	44	42	62	62	56	47	47	45	63	64	59	48	48	49					
		1200	566	0.12	30	42	37	33	27	21	-	52	48	43	37	37	33	56	56	49	41	42	41	58	59	54	44	45	45	59	61	58	47	47	48					
		800	378	0.05	12	-	-	23	-	-	-	48	44	37	33	33	28	51	50	47	38	40	38	53	53	50	41	43	43	52	54	52	44	45	46					
		400	189	0.01	2	-	-	-	-	-	-	43	40	35	30	31	27	45	45	43	36	38	37	47	47	46	40	41	42	50	50	49	43	44	45					
	14	2625	1239	0.39	97	55	51	48	42	38	34	55	52	49	44	39	36	63	59	55	46	44	44	64	62	57	48	47	48	66	66	61	51	49	51					
		2100	991	0.25	62	51	46	43	36	32	27	54	50	46	38	37	33	60	58	52	43	43	43	62	61	56	46	46	47	64	62	59	48	48	50					
		1575	743	0.14	35	46	40	35	28	22	-	52	46	42	35	35	31	56	53	48	40	41	40	60	58	54	44	45	46	61	59	57	47	48	47					
		1050	495	0.06	15	-	-	22	-	-	-	49	43	39	33	34	30	52	51	47	39	40	40	55	54	52	43	44	45	57	55	54	45	46	48					
		525	248	0.02	5	-	-	-	-	-	-	40	38	32	34	34	4	47	46	44	37	39	40	50	50	49	41	43	44	49	51	50	43	45	45					
5	10	1375	649	0.26	65	49	43	42	39	38	34	55	52	48	42	41	40	62	57	51	44	43	43	65	62	55	46	45	48	63	64	58	48	47	49					
		1100	519	0.17	42	45	40	39	36	34	29	59	54	50	43	39	37	60	57	50	42	42	42	61	61	54	44	44	47	63	63	57	46	46	49					
		825	389	0.11	27	45	36	33	30	26	-	51	47	39	33	33	31	56	54	47	39	40	40	58	57	51	41	42	44	57	59	54	44	43	46					
		550	260	0.04	10	-	33	28	21	-	-	48	44	37	31	31	30	52	50	44	36	37	37	56	56	50	40	41	43	55	56	52	42	42	45					
		275	130	0.01	2	-	-	-	-	-	-	40	35	28	29	28	-	43	42	33	35	35	-	44	45	37	38	39	47	47	47	40	41	42						
12	2000	943	0.28	71	60	52	49	44	40	37	63	56	51	45	42	39	70	62	55	47	45	44	71	65	58	49	47	47	73	67	61	51	49	49						
	1600	755	0.15	37	55	49	46	42	38	34	63	54	49	43	40	37	67	60	53	45	43	42	69	63	56	47	45	46	71	64	59	49	48	49						
	1200	566	0.10	24	53	46	44																																	

Performance Data • NC Level Application Guide

Model Series 35N • Parallel Flow • Fan Only • Heating Cycle
Fiberglass Liner

PSC Motor

Unit Size	Inlet Size	Airflow		Discharge ΔPs		NC Level	
		cfm	l/s	"w.g.	Pa	Discharge	Radiated
2	ALL	600	283	0.25	62	25	41
		500	236	0.25	62	20	35
		400	189	0.25	62	-	33
		300	142	0.25	62	-	32
3	ALL	1000	472	0.25	62	20	39
		850	401	0.25	62	-	36
		700	330	0.25	62	-	34
		550	260	0.25	62	-	33
5	ALL	1850	873	0.25	62	25	46
		1600	755	0.25	62	24	45
		1400	661	0.25	62	21	44
		1200	566	0.25	62	-	40
		1000	472	0.25	62	-	38
		800	378	0.25	62	-	34
6	ALL	2100	991	0.25	62	27	46
		1900	897	0.25	62	28	48
		1700	802	0.25	62	25	45
		1500	708	0.25	62	22	44
		1200	566	0.25	62	-	40

Performance Notes:

1. NC Levels are calculated based on procedures as outlined on page C160.
2. Dash (-) in space indicates a NC less than 20.

Performance Data • Sound Power Levels

Model Series 35N • Parallel Flow • Fan Only • Heating Cycle
Fiberglass Liner

Unit Size	Inlet Size	Airflow		Discharge ΔPs		Sound Power Octave Bands													
		cfm	l/s	"w.g.	Pa	Discharge							Radiated						
						2	3	4	5	6	7	2	3	4	5	6	7		
2	ALL	600	283	0.25	62	71	63	61	58	54	53	75	67	62	58	53	51		
		500	236	0.25	62	67	60	59	56	53	52	68	62	60	55	49	47		
		400	189	0.25	62	62	55	54	50	47	46	67	60	58	52	45	43		
		300	142	0.25	62	60	52	52	47	44	41	63	57	57	50	43	38		
3	ALL	1000	472	0.25	62	69	61	60	59	57	54	73	66	63	61	56	53		
		850	401	0.25	62	64	58	59	57	54	52	70	64	61	58	53	50		
		700	330	0.25	62	62	56	56	53	50	47	67	61	59	55	49	45		
		550	260	0.25	62	61	53	53	50	46	42	65	59	58	52	45	41		
5	ALL	1850	873	0.25	62	72	67	66	65	62	61	79	71	66	63	60	58		
		1600	755	0.25	62	72	66	64	63	60	59	78	70	64	61	58	56		
		1400	661	0.25	62	70	64	62	60	57	56	77	68	62	59	55	53		
		1200	566	0.25	62	68	60	59	56	54	52	74	65	60	56	52	49		
		1000	472	0.25	62	67	58	57	54	51	49	72	63	58	54	49	46		
		800	378	0.25	62	64	55	54	51	47	44	69	60	56	51	45	41		
6	ALL	2100	991	0.25	62	72	68	68	67	64	63	79	71	68	66	63	61		
		1900	897	0.25	62	72	69	67	67	64	63	80	71	66	65	62	60		
		1700	802	0.25	62	69	67	65	64	61	61	78	69	65	63	60	58		
		1500	708	0.25	62	67	64	63	62	59	58	77	67	63	61	58	55		
		1200	566	0.25	62	64	62	61	59	55	54	74	65	61	58	55	51		



For performance table notes, see page C142; highlighted numbers indicate embedded AHRI certification points.

Performance Data • AHRI Certification and Performance Notes

Model Series 35N • Parallel Flow • AHRI Certification Rating Points

Fiberglass Liner

Unit Size	Inlet Size	Primary Airflow		Min. Inlet ΔPs		100% Primary @ 1.5" w.g. (375 Pa) ΔPs w/ .25" w.g. (62 Pa) Discharge ΔPs														Fan Airflow		Fan† Watts	Fan Only* @ 25" w.g. (62 Pa) ΔPs													
						Discharge							Radiated										Discharge							Radiated						
		cfm	l/s	"w.g.	Pa	2	3	4	5	6	7	2	3	4	5	6	7	cfm	l/s	2	3	4	5	6	7	2	3	4	5	6	7					
2	6	400	189	0.15	37	72	70	63	56	54	57	66	62	58	48	42	40	600	283	254	71	63	61	58	54	53	75	67	62	58	53	51				
3	10	1100	519	0.16	40	71	72	65	57	59	62	67	63	57	48	43	41	1000	472	385	69	61	60	59	57	54	73	66	63	61	56	53				
5	12	1600	755	0.15	37	71	71	65	56	57	60	69	63	56	47	45	46	1850	873	995	72	67	66	65	62	61	79	71	66	63	60	58				
6	14	2100	991	0.14	35	75	72	66	59	61	65	71	65	60	51	48	49	2100	991	814	72	68	68	67	64	63	79	71	68	66	63	61				

† Motor = PSC.

*Primary air valve is closed and therefore primary cfm is zero.



Ratings are certified in accordance with AHRI Standards.

Performance Notes for Sound Power Levels:

- Discharge sound power is the noise emitted from the unit discharge into the downstream duct. Discharge Sound Power Levels (SWL) now include duct end reflection energy as part of the standard rating. Including the duct end correction provides sound power levels that would normally be transmitted into an acoustically, non-reflective duct. The effect of including the energy correction to the discharge SWL, is higher sound power levels when compared to previous AHRI certified data. For more information on duct end reflection calculations see AHRI Standard 880.
- Radiated sound power is the breakout noise transmitted through the unit casing walls.
- Sound power levels are in decibels, dB re 10⁻¹² watts.
- All sound data listed by octave bands is raw data without any corrections for room absorption or duct attenuation. Dash (-) in space indicates sound power level is less than 20 dB or equal to background.
- Minimum inlet ΔPs is the minimum operating pressure requirement of the unit (damper full open) to achieve rated primary CFM.
- Asterisk (*) in space indicates that the minimum inlet static pressure requirement is greater than 0.5" w.g. (125 Pa) at rated airflow.
- Data derived from independent tests conducted in accordance with ANSI/ASHRAE Standard 130 and AHRI Standard 880.
- 100% primary air sound power levels are cooling cycle (fan turned off).
- Fan airflow is rated fan volume at .25" w.g. (62 Pa) downstream static pressure.
- Fan only sound power levels are 100% recirculated air; fan only; in heating cycle.
- Fan Watts are the maximum electrical power input at rated fan volume.

Performance Data • Hot Water Coil

Model: 35NW • Parallel Flow

Unit Size 2

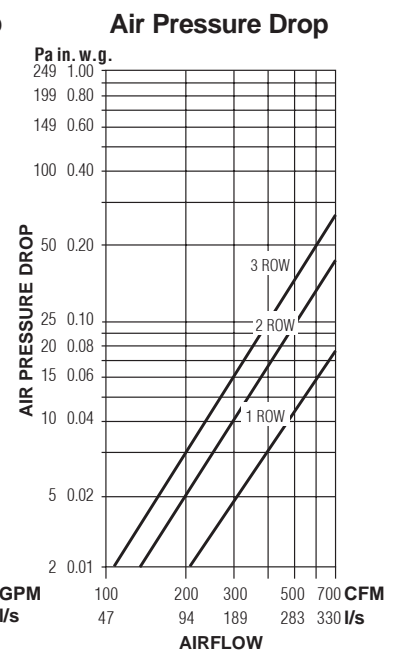
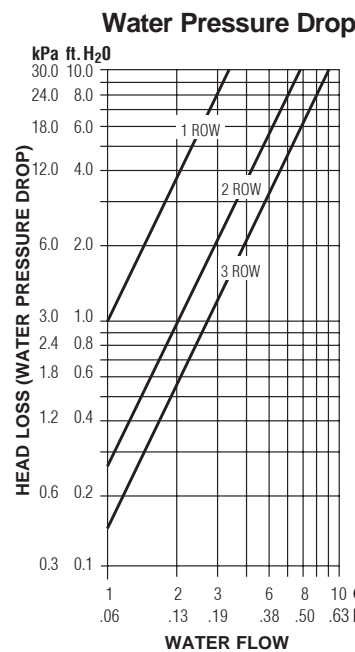
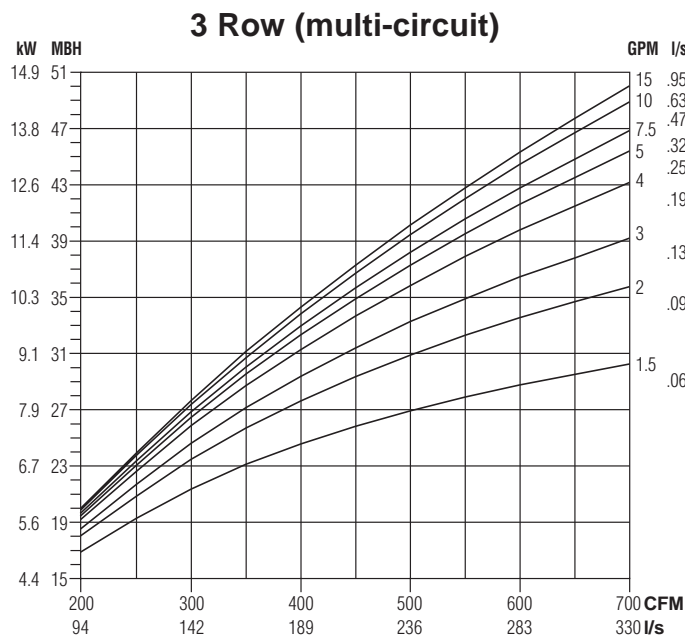
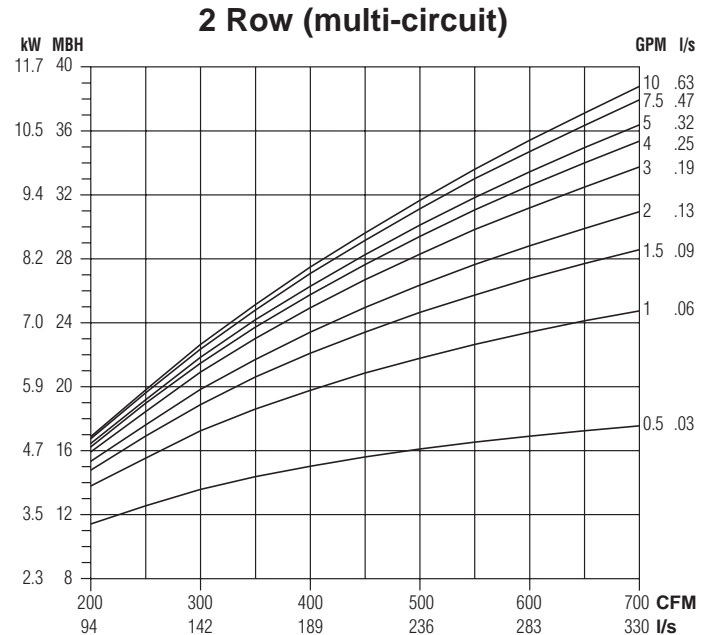
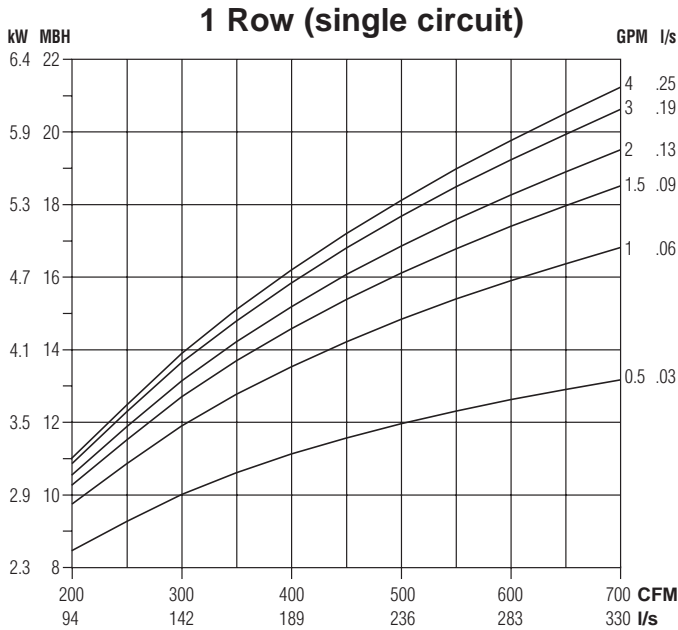

NOTES:

- Capacities are in MBH (kW), **thousands of Btu per hour (kiloWatts)**.
- MBH (kW) values are based on a Δt (temperature difference) of 110°F (61°C) between entering air and entering water. For other Δt's; multiply the MBH (kW) values by the factors below.

- Air Temperature Rise.

$$\text{ATR (°F)} = 927 \times \frac{\text{MBH}}{\text{cfm}}, \quad \text{ATR (°C)} = 829 \times \frac{\text{kW}}{\text{I/s}}$$

- Water Temp. Drop.

$$\text{WTD (°F)} = 2.04 \times \frac{\text{MBH}}{\text{GPM}}, \quad \text{WTD (°C)} = .224 \times \frac{\text{kW}}{\text{I/s}}$$

- Connections: 1 Row 1/2" (13), 2 and 3 Row 7/8" (22); O.D. male solder.

Altitude Correction Factors:

Altitude ft. (m)	Sensible Heat Factor
0 (0)	1.00
2000 (610)	0.94
3000 (914)	0.90
4000 (1219)	0.87
5000 (1524)	0.84
6000 (1829)	0.81
7000 (2134)	0.78

Correction factors at other entering conditions:

Δt °F (°C)	50 (28)	60 (33)	70 (39)	80 (44)	90 (50)	100 (56)	110 (61)	120 (67)	130 (72)	140 (78)	150 (83)
Factor	.455 (.459)	.545 (.541)	.636 (.639)	.727 (.721)	.818 (.820)	.909 (.918)	1.00 (1.00)	1.09 (1.10)	1.18 (1.18)	1.27 (1.28)	1.36 (1.36)

Performance Data • Hot Water Coil

Model: 35NW • Parallel Flow

Unit Size 3

1 Row (single circuit)

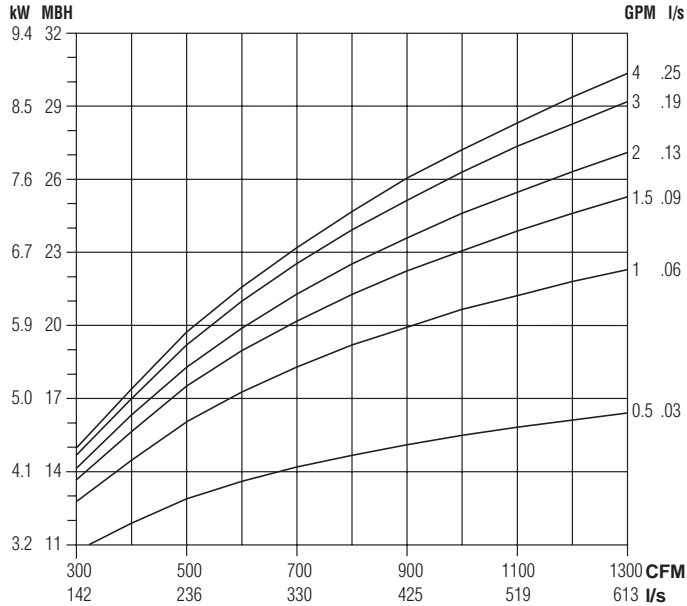

2 Row (multi-circuit)

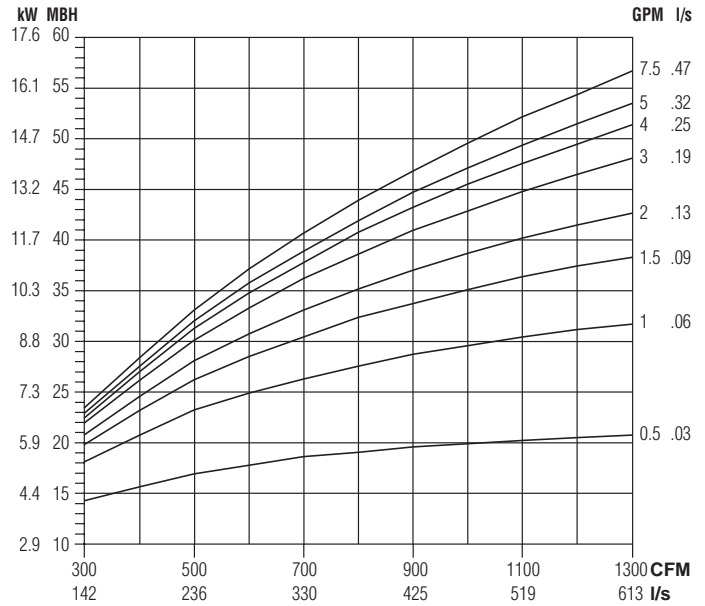

3 Row (multi-circuit)

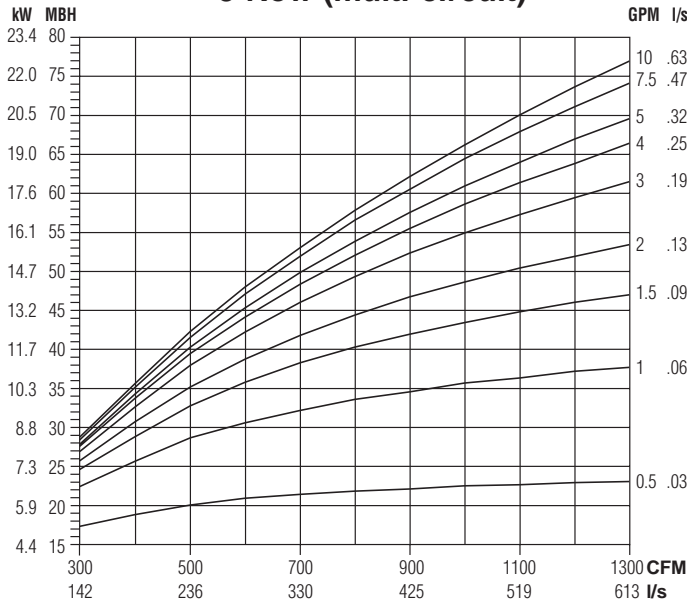

Water Pressure Drop

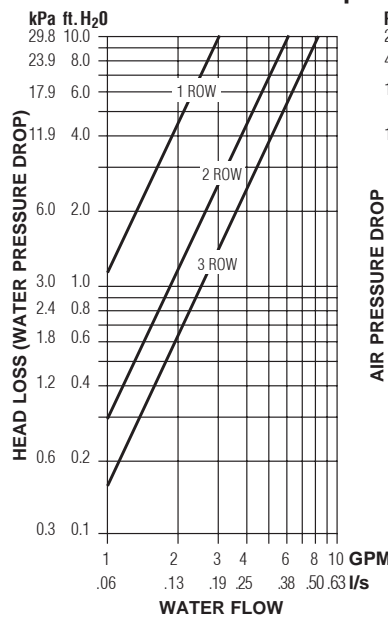

Air Pressure Drop

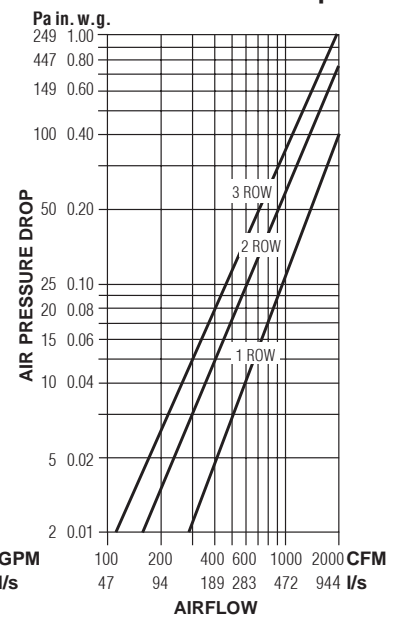

NOTES:

1. Capacities are in MBH (kW), *thousands of Btu per hour (kiloWatts)*.

2. MBH (kW) values are based on a Δt (temperature difference) of 110°F (61°C) between entering air and entering water. For other Δt 's; multiply the MBH (kW) values by the factors below.

3. Air Temperature Rise.

$$\text{ATR (°F)} = 927 \times \frac{\text{MBH}}{\text{cfm}}, \quad \text{ATR (°C)} = 829 \times \frac{\text{kW}}{\text{l/s}}$$

4. Water Temp. Drop.

$$\text{WTD (°F)} = 2.04 \times \frac{\text{MBH}}{\text{GPM}}, \quad \text{WTD (°C)} = .224 \times \frac{\text{kW}}{\text{l/s}}$$

5. Connections: 1 Row 1/2" (13), 2 and 3 Row 7/8" (22); O.D. male solder.

Altitude Correction Factors:

Altitude ft. (m)	Sensible Heat Factor
0 (0)	1.00
2000 (610)	0.94
3000 (914)	0.90
4000 (1219)	0.87
5000 (1524)	0.84
6000 (1829)	0.81
7000 (2134)	0.78

Correction factors at other entering conditions:

Δt °F (°C)	50 (28)	60 (33)	70 (39)	80 (44)	90 (50)	100 (56)	110 (61)	120 (67)	130 (72)	140 (78)	150 (83)
Factor	.455 (.459)	.545 (.541)	.636 (.639)	.727 (.721)	.818 (.820)	.909 (.918)	1.00 (1.00)	1.09 (1.10)	1.18 (1.18)	1.27 (1.28)	1.36 (1.36)

Performance Data • Hot Water Coil

Model: 35NW • Parallel Flow

Unit Size 5

1 Row (multi-circuit)

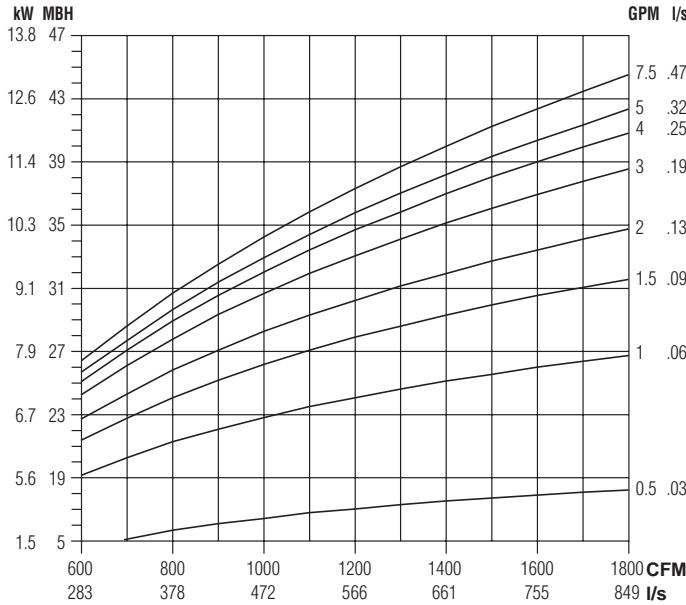

2 Row (multi-circuit)

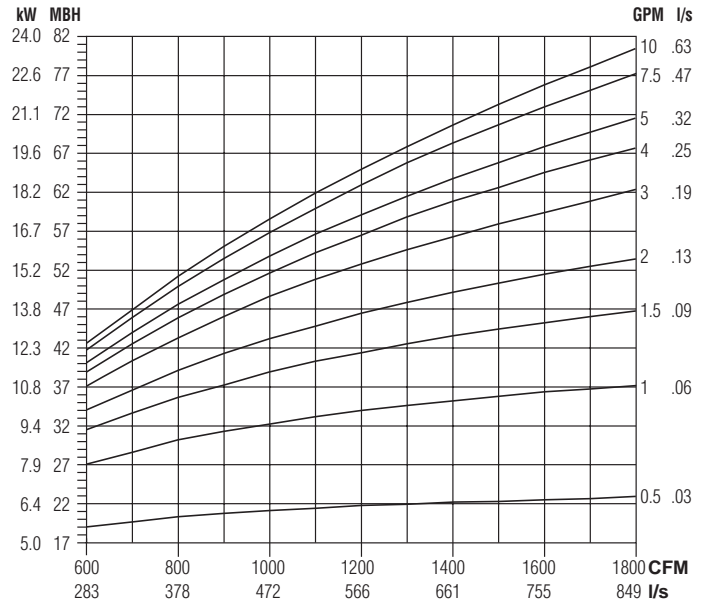

3 Row (multi-circuit)

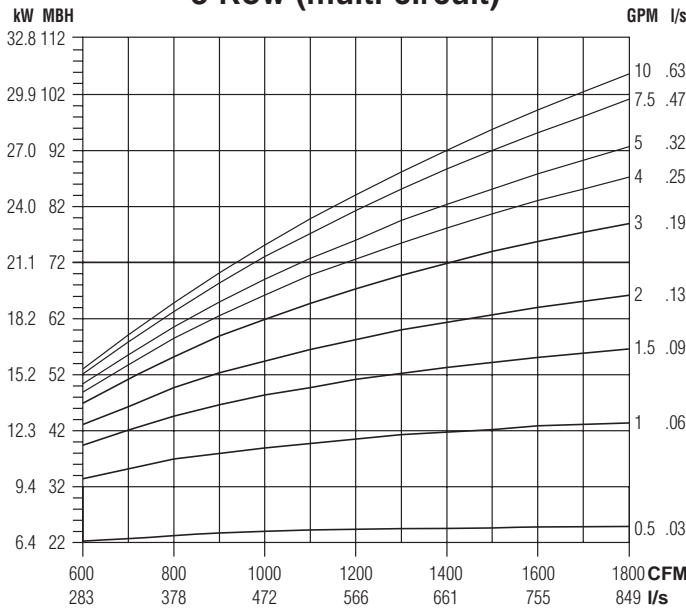

Water Pressure Drop

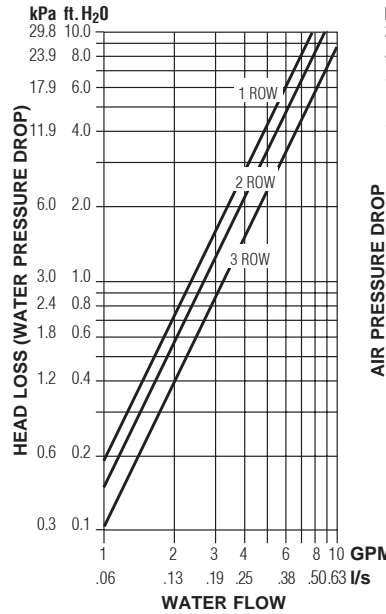

Air Pressure Drop

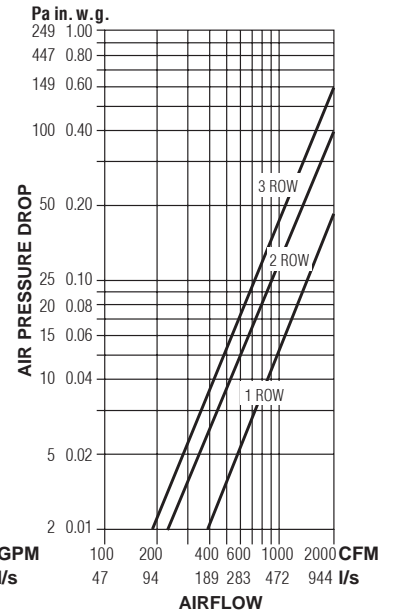

NOTES:

- Capacities are in MBH (kW), **thousands of Btu per hour (kiloWatts)**.
- MBH (kW) values are based on a Δt (temperature difference) of 110°F (61°C) between entering air and entering water. For other Δt 's; multiply the MBH (kW) values by the factors below.

- Air Temperature Rise.

$$\text{ATR (}^\circ\text{F)} = 927 \times \frac{\text{MBH}}{\text{cfm}}, \text{ ATR (}^\circ\text{C)} = 829 \times \frac{\text{kW}}{\text{I/s}}$$

- Water Temp. Drop.

$$\text{WTD (}^\circ\text{F)} = 2.04 \times \frac{\text{MBH}}{\text{GPM}}, \text{ WTD (}^\circ\text{C)} = .224 \times \frac{\text{kW}}{\text{I/s}}$$

- Connections: 1, 2 and 3 Row 7/8" (22); O.D. male solder.

Altitude Correction Factors:

Altitude ft. (m)	Sensible Heat Factor
0 (0)	1.00
2000 (610)	0.94
3000 (914)	0.90
4000 (1219)	0.87
5000 (1524)	0.84
6000 (1829)	0.81
7000 (2134)	0.78

Correction factors at other entering conditions:

Δt °F (°C)	50 (28)	60 (33)	70 (39)	80 (44)	90 (50)	100 (56)	110 (61)	120 (67)	130 (72)	140 (78)	150 (83)
Factor	.455 (.459)	.545 (.541)	.636 (.639)	.727 (.721)	.818 (.820)	.909 (.918)	1.00 (1.00)	1.09 (1.10)	1.18 (1.18)	1.27 (1.28)	1.36 (1.36)

Performance Data • Hot Water Coil

Model: 35NW • Parallel Flow

Unit Size 6

1 Row (multi-circuit)

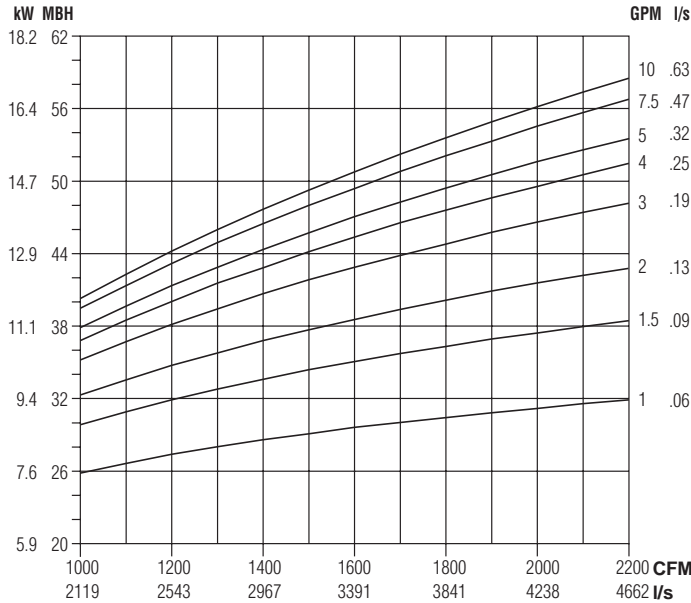

2 Row (multi-circuit)

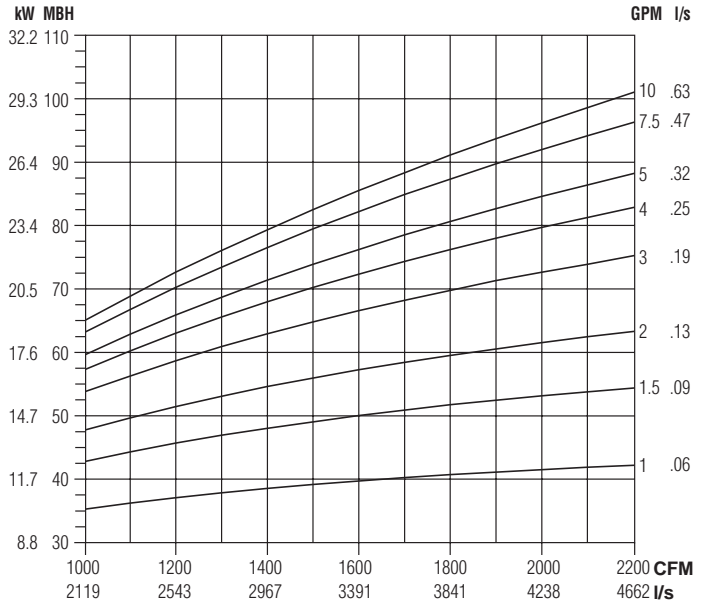

3 Row (multi-circuit)

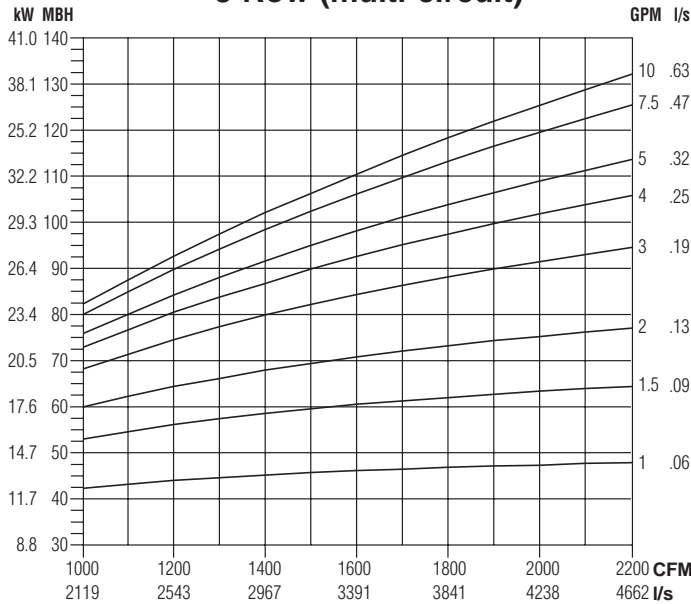

Water Pressure Drop

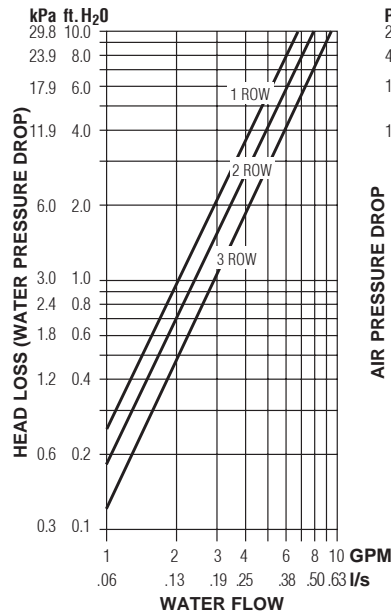

Air Pressure Drop

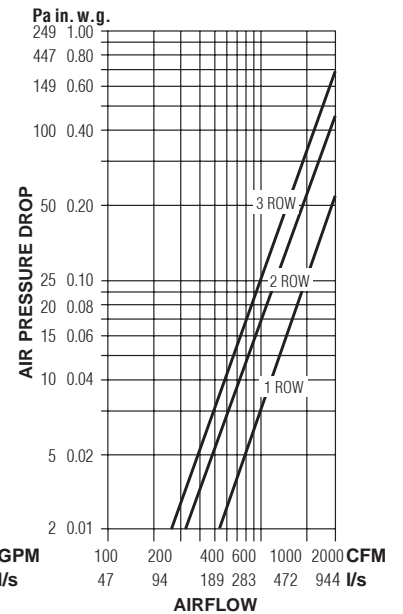

NOTES:

- Capacities are in MBH (kW), *thousands of Btu per hour (kiloWatts)*.
- MBH (kW) values are based on a Δt (temperature difference) of 110°F (61°C) between entering air and entering water. For other Δt 's; multiply the MBH (kW) values by the factors below.

- Air Temperature Rise.
 $ATR (^{\circ}F) = 927 \times \frac{MBH}{cfm}$, $ATR (^{\circ}C) = 829 \times \frac{kW}{l/s}$
- Water Temp. Drop.
 $WTD (^{\circ}F) = 2.04 \times \frac{MBH}{GPM}$, $WTD (^{\circ}C) = .224 \times \frac{kW}{l/s}$
- Connections: 1, 2 and 3 Row 7/8" (22); O.D. male solder.

Altitude Correction Factors:

Altitude ft. (m)	Sensible Heat Factor
0 (0)	1.00
2000 (610)	0.94
3000 (914)	0.90
4000 (1219)	0.87
5000 (1524)	0.84
6000 (1829)	0.81
7000 (2134)	0.78

Correction factors at other entering conditions:

Δt °F (°C)	50 (28)	60 (33)	70 (39)	80 (44)	90 (50)	100 (56)	110 (61)	120 (67)	130 (72)	140 (78)	150 (83)
Factor	.455 (.459)	.545 (.541)	.636 (.639)	.727 (.721)	.818 (.820)	.909 (.918)	1.00 (1.00)	1.09 (1.10)	1.18 (1.18)	1.27 (1.28)	1.36 (1.36)

**PARALLEL FLOW
VARIABLE VOLUME**

**37N SERIES
• LOW PROFILE**



Model 37NW

Models:

- 37N No Heat**
- 37NE Electric Heat**
- 37NW Hot Water Heat**

The **37N Low Profile Series** provides many standard design features and excellent sound performance when compared with other parallel designs. The 37N offers a compact and economical design that provides excellent performance in the most demanding variable air volume/intermittent fan applications. The fan is mounted at ninety degrees to the primary airflow to provide optimum mixing.

STANDARD FEATURES:

- Only 11" (279) to 12 1/2" (318) high.
- 20 ga. (1.0) galvanized steel construction.
- 2 x 20 ga. (1.0) round or rectangular primary air damper with a polyurethane peripheral gasket. 90° rotation, CW to close. 1/2" (13) dia. plated steel drive shaft. An indicator mark on the end of the shaft shows damper-position. Damper leakage is less than 2% of nominal flow at 3" w.g. (750 Pa).
- Round or rectangular 6" (152) deep inlet collars for field duct connection.
- Multi-point averaging Diamond Flow sensor (pressure independent control only).
- Access panels on underside of terminal for ease of maintenance and service.
- Energy efficient PSC fan motor with thermal overload protection.
- Solid state fan speed controller with minimum voltage stop.
- Motor blower assembly mounted on special 16 ga. (1.61) angles and isolated from casing with rubber isolators.
- Gasketed backdraft damper mounted on fan discharge restricts primary air escaping through the fan section into the ceiling plenum.

- Hinged door on fan controls enclosure.
- 1/2" (13) dual density insulation. Exposed edges coated to prevent air erosion. Meets requirements of NFPA 90A and UL 181.
- Available with electric or hot water supplementary heat.
- Hot water coils are mounted on induced air inlet of 37NW unit and are designed to accept flanged duct connection.
- Electric coils are mounted on unit discharge.
- Single point electrical and/or pneumatic main air connection.
- Discharge opening designed for flanged duct connection.
- Full primary air valve low voltage NEMA 1 type enclosure for factory mounted DDC and analog electronic controls.

Controls:

- Nailor EZvav
- Analog electronic and pneumatic controls. Factory supplied, mounted and calibrated.
- Digital controls. Factory mounting and wiring of DDC controls. Controls supplied by BAS controls contractor.

Options:

- ECM/EPIC Fan Technology®.
- Induced air filter, 1" (25) thick, disposable type.
- Primary air valve enclosure for field mounted controls.
- Toggle disconnect switch. Units with electric heat also offer door Interlocking type.
- Various IAQ linings are available.
- Fan airflow switch for night shutdown.
- Night setback fan/heat cycle (pneumatic and analog).
- Fan unit fusing.
- Hanger brackets.
- Induced air attenuator.



Dimensions

Model Series 37N • Parallel Flow • Low Profile

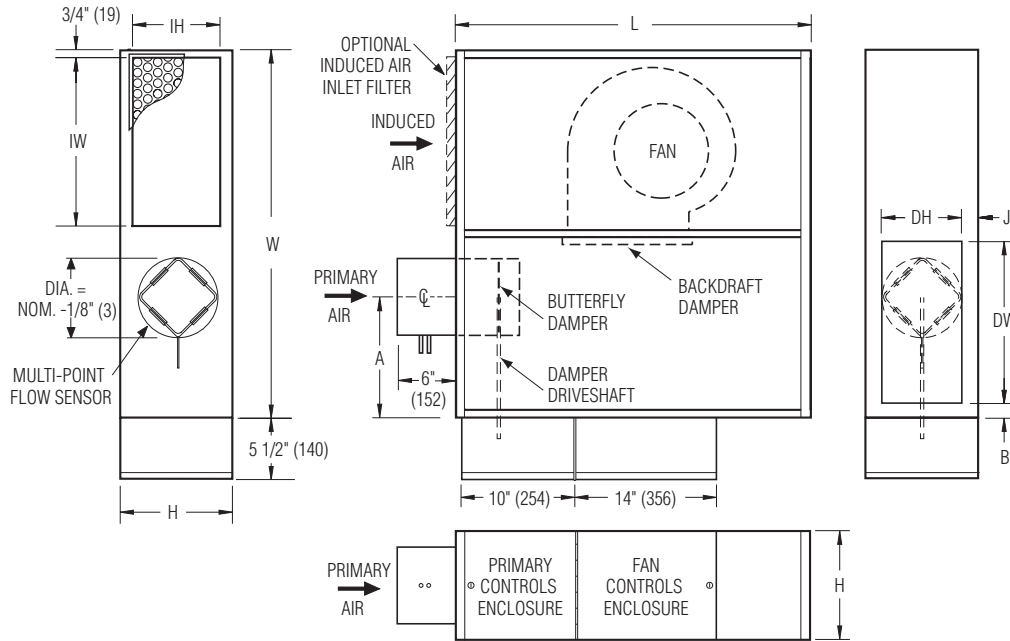

Right hand unit, top view illustrated. Controls mounted as standard on RH side as shown. Left hand terminals ordered with LH controls (optional), are built as mirror image. Inlet, discharge and control enclosure are opposite of the drawing.

Dimensional Data

Unit Size	Inlet Size	W	L	H	A	Induced Air Inlet IW x IH	Outlet Discharge DW x DH	B	J	Filter (Optional) Size
2	6 (152), 8 (203), 10 (254)	32 (813)	36 (914)	11 (279)	7 7/8 (200), 6 1/2 (165)	12 x 10 (305 x 254)	10 x 8 (254 x 203)	1 1/2 (38)	1 1/2 (38)	14 x 11 (356 x 279)
3	8 (203), 10 (254), 14 x 8 (356 x 203)	38 (965)	36 (914)	11 (279)	12 (305), 8 1/8 (206)	16 x 10 (406 x 254)	16 x 8 (406 x 203)	1 1/2 (38)	1 1/2 (38)	18 x 11 (457 x 279)
4*	14 x 8 (356 x 203), 14 x 10 (356 x 254)	43 (1092)	36 (914)	12 1/2 (318)	13 (330)	19 x 10 (483 x 254)	19 x 11 (483 x 279)	1 (25)	3/4 (19)	21 x 11 (533 x 279)

*Unit size 4 with rectangular damper, 90° rotation.

Options and Accessories:

Q option – Induced Air Attenuator

- 22 ga. (0.86) galvanized steel construction.
- Shipped loose for field attachment.
- Flanged connection.
- 1/2" (13) thick dual density fiberglass liner. Meets requirements of NFPA 90A & UL 181.

Without HW Coil

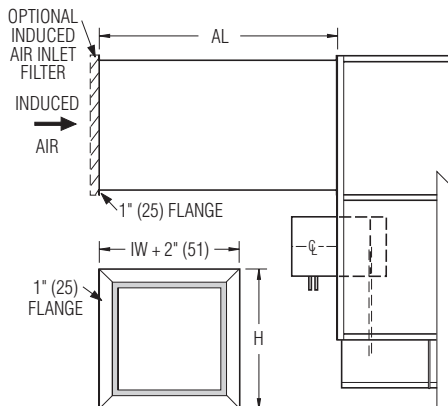

With HW Coil

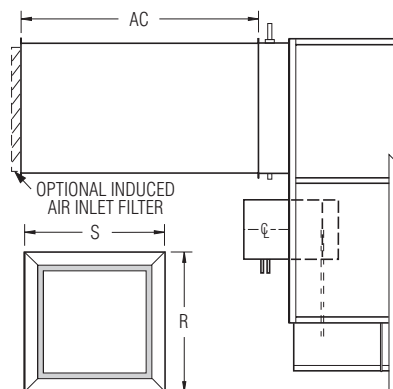

Unit Size	H	IW	S	R	AL	AC
2	11 (279)	12 (305)	13 (330)	11 (279)	36 (914)	36 (914)
3	11 (279)	16 (406)	17 (432)	11 (279)	36 (914)	36 (914)
4	12 1/2 (318)	19 (483)	22 (559)	11 (279)	36 (914)	36 (914)

Dimensions

Model Series 37N • Parallel Flow • Low Profile

Hot Water Coil Section

Model 37NW

Available in one or two row. Coil section mounted on induced air inlet.

Standard Features:

- 1/2" (13) copper tubes.
- Aluminum ripple fins.
- Sweat Connections: 1/2" (13); O. D. male solder.
- 2 Row 7/8" (22); O.D. male solder.

Coil Hand Connections:

(Looking in direction of airflow).

- Left hand (illustrated). Standard.
- Right hand (terminals are inverted. Built as mirror image) Optional.

Connections must be selected opposite hand to controls enclosure location.

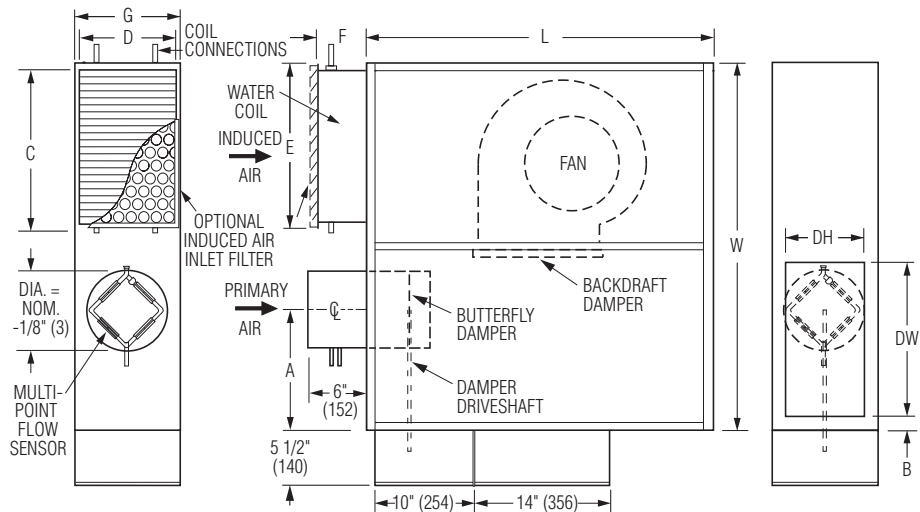

Unit Size	W	L	H	B	C x D	E	F	G	DW x DH
2	32 (813)	36 (914)	11 (279)	1 1/2 (38)	12 x 10 (305 x 254)	13 (330)	5 (127)	11 (279)	10 x 8 (254 x 203)
3	38 (965)	36 (914)	11 (279)	1 1/2 (38)	16 x 10 (406 x 254)	17 (432)	5 (127)	11 (279)	16 x 8 (406 x 203)
4	43 (1092)	36 (914)	12 1/2 (318)	1 (25)	21 x 10 (533 x 254)	22 (559)	5 (127)	11 (279)	19 x 11 (483 x 279)

Electric Coil Section

Model 37NE

Standard Features:

- Unique hinged heater design permits easy access, removal and replacement of heater element without disturbing ductwork.
- Coil installed on unit discharge.
- Insulated coil element wrapper.
- Automatic reset high limit cut-outs (one per element).
- Single point electrical connection (except 600V).
- Magnetic contactors per stage.
- Class A 80/20 Ni/Cr wire.
- Positive pressure airflow switch.
- Flanged outlet duct connection.
- Terminal unit with coil is ETL Listed as an assembly.
- Controls mounted as standard on RH side as shown. Terminals ordered with LH controls (optional) are built as mirror image.

Standard Supply Voltage (60 Hz):

- Single phase: 120, 208, 240 & 277V.
- Three phase: 208, 480 (4 wire wye) and 600V (dual point connection).

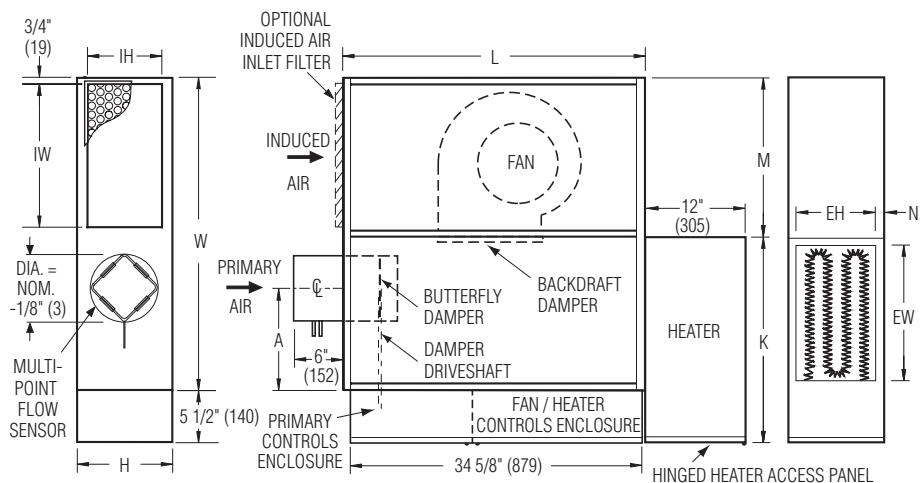

Options:

- Toggle disconnect switch (includes fan).
- Door interlock disconnect switch.
- Power circuit fusing.
- Dust tight construction.
- Manual reset secondary thermal cut out.

Unit Size	W	L	H	IW x IH	K	M	N	EW x EH
2	32 (813)	36 (914)	11 (279)	12 x 10 (305 x 254)	18 1/2 (470)	19 (483)	1 1/2 (38)	10 1/2 x 9 (267 x 229)
3	38 (965)	36 (914)	11 (279)	16 x 10 (406 x 254)	24 1/2 (622)	19 (483)	1 1/2 (38)	16 1/2 x 9 (419 x 229)
4	43 (1092)	36 (914)	12 1/2 (318)	19 x 10 (483 x 254)	27 (686)	22 (559)	3/4 (19)	19 x 10 1/2 (483 x 267)

Performance Data

PSC Motor Fan Curves – Airflow vs. Downstream Static Pressure
37N Series • Parallel Flow • Low Profile

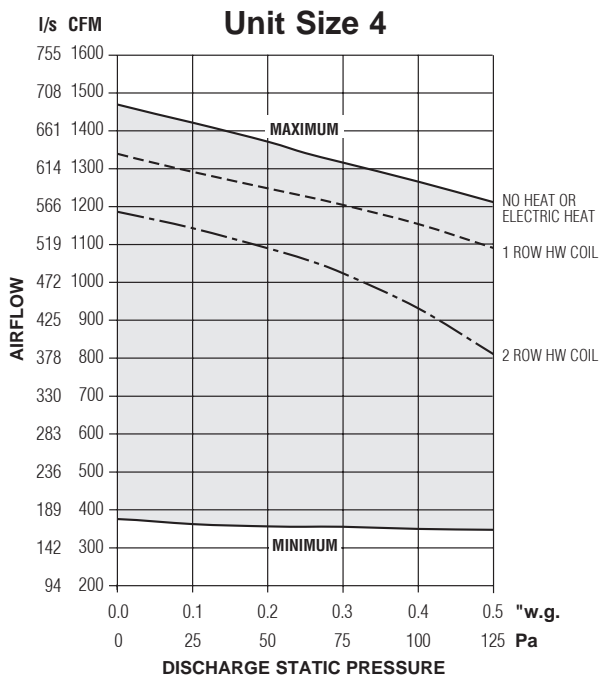
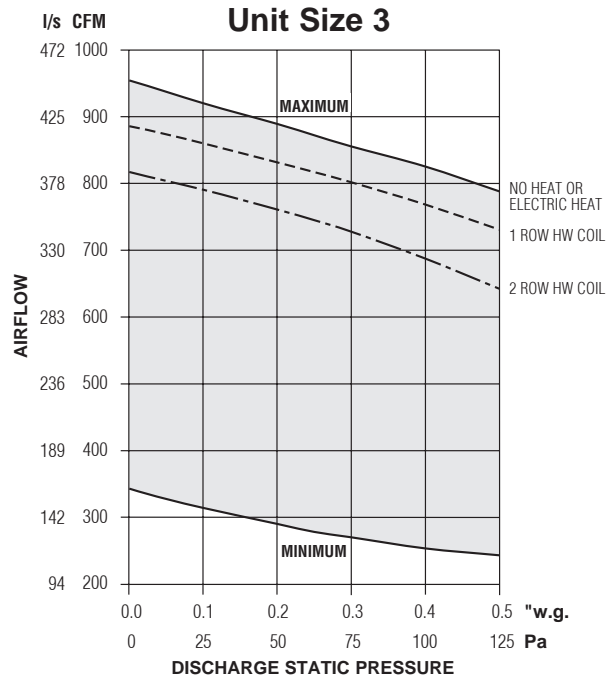
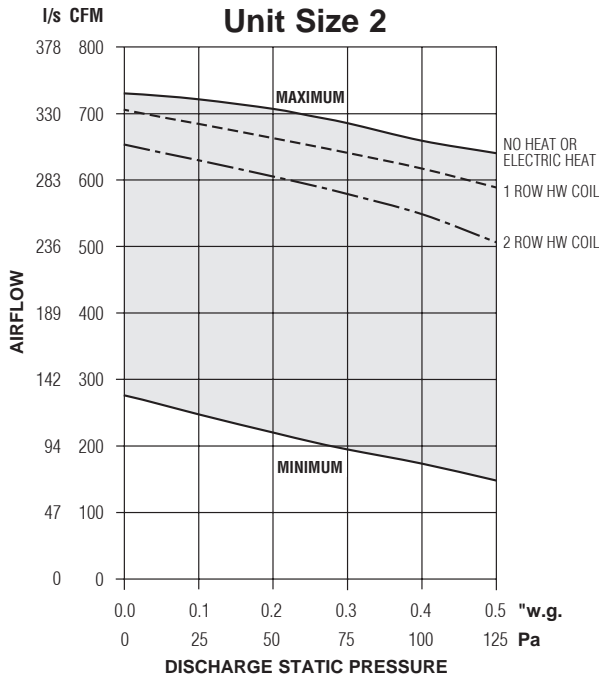

- Fan curves shown are applicable to 120, 208, 240 and 277 volt, single phase PSC motors.

Electrical Data

Unit Size	Motor H.P.	PSC MOTOR FLA			
		120/1/60	208/1/60	240/1/60	277/1/60
2	1/6	4.6	1.8	1.8	1.3
3	1/4	5.4	2.2	2.2	1.7
4	1/2	7.5	3.5	3.5	2.6

FLA = Full load amperage.

Performance Data

ECM Motor Fan Curves – Airflow vs. Downstream Static Pressure

37N Series • Parallel Flow • Low Profile

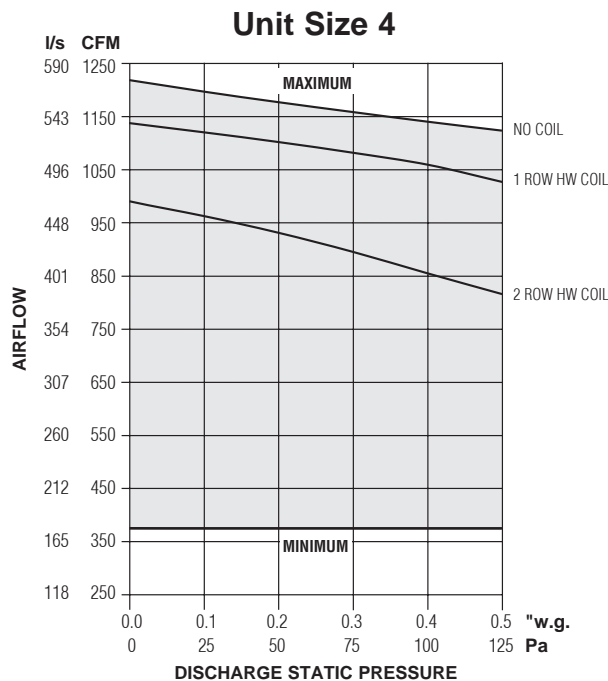
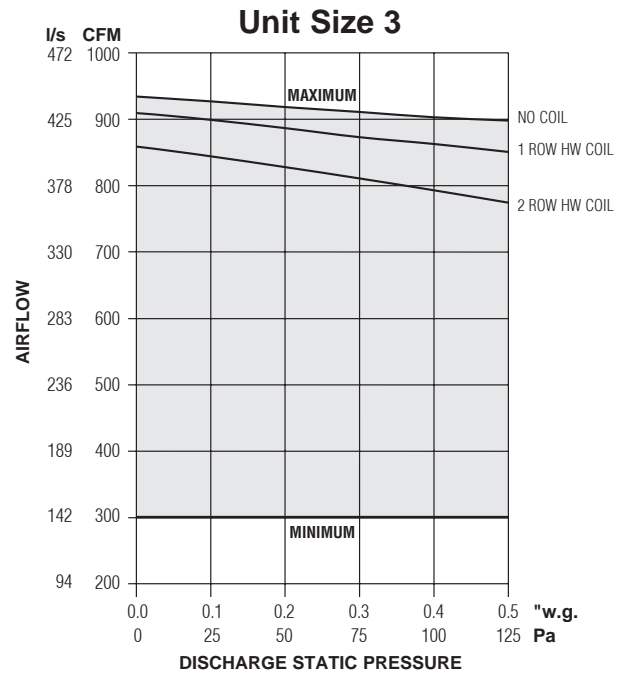
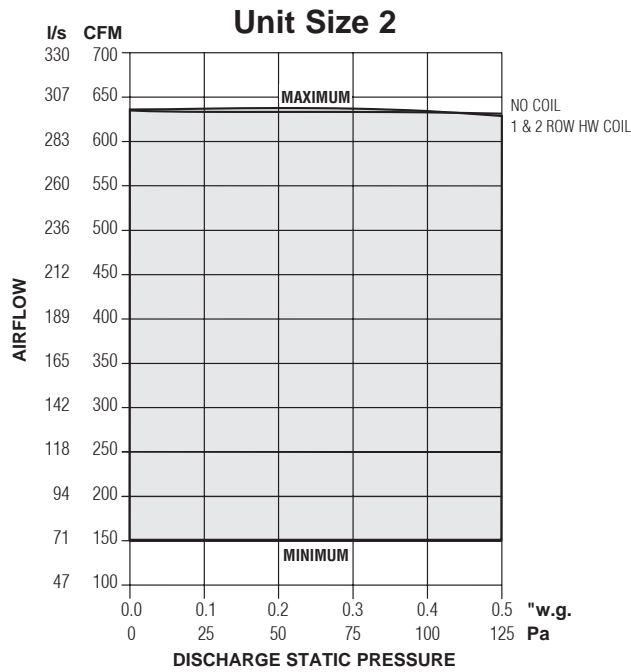

NOTES:

- The ECM is pressure independent and constant volume in operation at factory or field set point within the shaded area. Airflow does not vary with changing static pressure conditions. The motor compensates for any changes in external static pressure or induced air conditions such as filter loading.
- Airflow can be set to operate on horizontal performance line at any point within shaded area using the solid state volume controller provided.
- Fan curves shown are applicable to 120/240, 208 and 277 volt, single phase ECM's. ECM's, although DC in operation, include a built-in AC/DC converter.

Electrical Data

Unit Size	EPIC ECM Motor FLA				
	Motor HP	120V	208V	230V	277V
2	*	2.1	1.5	1.5	1.4
3	*	4.2	2.5	2.6	2.6
4	*	5.1	3.7	3.7	3.8

* The ECM is a variable horsepower motor.
 Refer to Selectworks Schedule for actual power consumption.
 FLA = Full load amperage.
 All motors are single phase/60 Hz.

Performance Data • NC Level Application Guide

Model Series 37N • Parallel Flow • 100% Primary Air • Cooling Cycle

Fiberglass Liner

Unit Size	Inlet Size	Airflow		Min. inlet ΔPs		NC Levels @ Inlet pressure (ΔPs) shown									
						DISCHARGE					RADIATED				
						Min. ΔPs	0.5" w.g. (125 Pa)	1.0" w.g. (250 Pa)	1.5" w.g. (375 Pa)	2.0" w.g. (500 Pa)	Min. ΔPs	0.5" w.g. (125 Pa)	1.0" w.g. (250 Pa)	1.5" w.g. (375 Pa)	2.0" w.g. (500 Pa)
2	6	450	212	0.19	47	-	-	26	31	35	-	25	31	35	36
		400	189	0.16	40	-	-	25	30	34	-	23	31	34	35
		300	142	0.10	25	-	-	21	28	30	-	21	28	30	31
		200	94	0.05	12	-	-	-	24	26	-	-	23	24	26
		100	47	0.02	5	-	-	-	-	-	-	-	-	-	-
	8	800	378	0.11	27	-	-	25	30	33	-	29	38	40	39
		700	330	0.08	20	-	-	24	29	31	-	29	36	38	39
		600	283	0.06	15	-	-	23	26	29	-	26	34	35	35
		400	189	0.03	7	-	-	-	20	20	-	21	26	26	26
		175	83	0.01	2	-	-	-	-	-	-	-	21	21	23
	10	1400	661	0.27	67	20	25	31	35	37	28	29	36	41	43
		1100	519	0.16	40	-	21	28	31	34	-	28	34	39	40
		825	389	0.09	22	-	-	24	29	31	-	24	33	35	36
		550	260	0.04	10	-	-	20	24	25	-	21	28	29	31
		275	130	0.01	2	-	-	-	-	-	-	-	20	24	25
3	8	800	378	0.14	35	-	21	25	29	31	-	28	34	36	38
		700	330	0.10	25	-	21	26	29	30	-	24	31	34	35
		600	283	0.07	17	-	-	24	26	29	-	21	29	31	33
		400	189	0.03	7	-	-	-	-	21	-	-	21	23	25
		175	83	0.01	2	-	-	-	-	-	-	-	-	21	24
	10	1400	661	0.30	75	23	26	31	36	38	28	33	38	41	44
		1100	519	0.17	42	-	23	28	33	35	20	29	34	38	40
		825	389	0.09	22	-	-	25	29	30	-	25	30	34	35
		550	260	0.04	10	-	-	23	24	25	-	20	25	28	29
		275	130	0.01	2	-	-	-	-	20	-	-	-	22	24
	14 x 8	2100	991	0.30	75	20	24	33	37	41	26	33	38	43	45
		1600	755	0.17	42	-	20	29	33	34	21	30	36	40	41
		1200	566	0.10	25	-	-	23	28	29	-	28	33	35	38
		800	378	0.04	10	-	-	-	21	24	-	-	26	29	30
		400	189	0.01	2	-	-	-	21	20	-	-	20	26	29
4	14 x 8	2100	991	0.08	20	20	29	33	38	39	24	34	38	41	44
		1600	755	0.04	10	-	23	28	33	34	-	30	35	40	43
		1200	566	0.02	5	-	-	23	28	29	-	24	30	34	35
		800	378	0.01	2	-	-	-	21	24	-	-	25	26	28
		400	189	0.01	2	-	-	-	21	21	-	-	-	26	29
	14 x 10	2700	1274	0.10	25	20	28	34	38	40	26	34	40	45	49
		1950	920	0.05	12	-	23	29	34	35	-	30	36	43	45
		1550	731	0.03	7	-	20	26	31	33	-	26	34	39	41
		1050	495	0.01	2	-	-	21	25	28	-	21	29	34	36
		525	248	0.01	2	-	-	-	-	20	-	-	-	24	26

Performance Notes:

1. NC Levels are calculated based on procedures as outlined on page C160.
2. Dash (-) in space indicates a NC less than 20.

Performance Data • Discharge Sound Power Levels
 Model Series 37N • Parallel Flow • 100% Primary Air • Cooling Cycle
 Fiberglass Liner



Unit Size	Inlet Size	Airflow		Min. inlet ΔPs		Fan and 100% Primary Air – Sound Power Octave Bands @ Inlet pressure (ΔPs) shown																																		
						Minimum ΔPs						0.5" w.g. (125Pa) ΔPs						1.0" w.g. (249Pa) ΔPs						1.5" w.g. (375Pa) ΔPs						2.0" w.g. (500Pa) ΔPs										
						2	3	4	5	6	7	2	3	4	5	6	7	2	3	4	5	6	7	2	3	4	5	6	7	2	3	4	5	6	7					
2	6	450	212	0.19	47	60	55	51	44	34	32	64	60	57	49	37	36	70	67	62	55	41	40	75	71	66	58	44	44	76	74	68	58	45	46					
		400	189	0.16	40	63	53	49	41	31	29	64	59	56	47	35	33	70	66	61	53	39	38	74	70	65	56	42	42	75	73	67	57	44	45					
		300	142	0.10	25	56	47	43	35	26	21	62	57	53	44	31	29	68	63	58	49	36	36	71	68	62	52	40	41	71	70	65	54	42	44					
		200	94	0.05	12	-	40	35	25	-	-	59	53	49	40	26	25	63	60	55	45	33	35	64	64	59	48	38	41	65	66	62	50	40	44					
		100	47	0.02	5	-	-	24	-	-	-	-	50	45	37	24	24	55	56	51	40	31	35	56	59	57	45	36	39	58	60	59	48	39	41					
	8	800	378	0.11	27	58	53	47	41	33	28	67	62	55	51	40	35	71	67	60	55	43	39	73	71	65	58	45	42	75	73	67	60	47	44					
		700	330	0.08	20	56	50	44	38	30	24	64	60	53	49	38	32	70	65	59	53	41	36	72	69	62	56	43	40	73	71	65	58	45	42					
		600	283	0.06	15	-	47	41	35	27	21	62	58	51	47	35	29	68	64	57	51	38	34	70	67	61	54	41	39	71	69	63	56	43	42					
		400	189	0.03	7	-	42	37	30	25	-	59	55	48	43	30	24	63	59	54	47	34	33	64	62	57	50	36	39	64	62	58	52	37	40					
		175	83	0.01	2	-	-	26	-	-	-	-	47	43	35	28	23	55	52	50	41	25	34	55	54	56	48	31	30	55	55	59	52	34	33					
	10	1400	661	0.27	67	69	63	56	51	48	44	71	67	60	53	49	44	75	72	65	57	52	47	77	75	69	60	54	49	79	77	71	62	55	50					
		1100	519	0.16	40	63	58	51	46	42	36	69	64	57	50	45	39	73	69	62	54	48	42	75	72	66	57	50	45	76	74	69	60	52	47					
		825	389	0.09	22	-	52	46	41	35	27	65	61	53	46	40	33	70	66	59	51	44	37	72	70	64	55	48	43	74	72	66	57	49	44					
		550	260	0.04	10	-	46	40	34	27	-	62	57	49	42	34	27	65	62	56	47	40	36	67	65	59	50	42	37	69	66	60	52	43	39					
		275	130	0.01	2	-	40	35	29	24	-	58	51	45	37	29	27	59	55	50	40	31	27	61	57	53	44	34	31	62	59	55	47	37	34					
3	8	800	378	0.14	35	63	56	49	43	37	31	70	63	55	50	40	35	73	67	60	54	43	39	76	70	64	57	46	42	77	72	65	59	47	44					
		700	330	0.10	25	61	53	46	40	33	27	68	60	53	48	38	32	72	65	59	52	41	37	74	68	62	55	44	40	75	70	64	57	46	43					
		600	283	0.07	17	57	49	43	38	30	23	65	58	52	47	36	30	70	64	58	51	40	37	72	66	61	54	42	39	74	69	63	56	44	41					
		400	189	0.03	7	-	42	37	32	27	-	60	53	48	45	32	25	65	58	54	47	35	35	66	61	57	51	38	36	68	63	59	53	40	37					
		175	83	0.01	2	-	-	-	23	-	-	-	47	43	34	-	-	55	53	53	43	28	25	57	55	57	48	33	31	56	55	59	52	36	35					
	10	1400	661	0.30	75	71	64	58	52	46	41	74	67	61	54	48	42	78	72	66	59	51	46	82	76	70	62	54	48	83	78	73	65	55	50					
		1100	519	0.17	42	65	57	52	46	40	34	71	64	58	51	44	38	75	69	63	55	47	41	79	73	68	60	51	46	81	75	70	63	53	48					
		825	389	0.09	22	58	52	47	41	35	28	68	60	55	48	40	33	73	66	60	53	44	38	76	70	65	57	47	44	77	71	66	59	49	45					
		550	260	0.04	10	-	45	40	35	29	-	63	56	51	45	36	28	69	62	56	49	40	37	70	64	59	51	42	39	71	65	60	52	43	41					
		275	130	0.01	2	-	-	32	30	26	-	56	49	46	38	34	25	60	53	50	41	32	36	62	56	54	45	36	33	64	58	56	48	38	36					
	14 x 8	2100	991	0.30	75	68	63	58	53	47	44	71	66	61	55	48	46	76	73	66	59	52	50	80	77	70	62	55	54	84	81	74	67	61	60					
		1600	755	0.17	42	62	56	51	47	41	35	69	63	58	51	44	41	75	70	63	56	48	48	78	73	66	59	51	51	79	74	68	61	53	53					
		1200	566	0.10	25	55	50	46	41	35	29	67	60	55	49	40	39	71	65	60	53	45	45	73	69	63	56	49	48	74	70	65	57	50	50					
		800	378	0.04	10	-	43	40	35	28	-	60	55	51	45	36	35	64	60	55	49	41	39	67	64	59	51	44	44	68	66	62	54	45	47					
		400	189	0.01	2	-	-	35	32	30	-	-	49	45	39	32	26	57	59	53	44	36	36	58	63	60	49	41	41	58	62	62	51	44	44					
4	14 x 8	2100	991	0.08	20	69	60	56	52	44	43	76	67	63	56	49	48	79	71	67	60	52	52	83	75	71	63	55	55	84	76	72	64	57	57					
		1600	755	0.04	10	61	53	49	44	36	33	71	63	59	52	44	43	75	68	64	56	49	49	79	72	67	59	52	53	80	74	70	61	55	55					
		1200	566	0.02	5	-	46	42	37	29	23	67	59	55	48	40	39	71	64	61	53	46	47	75	68	65	56	50	52	76	70	67	58	51	53					
		800	378	0.01	2	-	40	36	30	25	-	61	54	51	44	36	37	66	60	57	49	43	43	68	64	61	52	46	47	68	66	63	54	47	49					
		400	189	0.01	2	-	-	33	28	24	-	59	50	47	40	33	34	57	59	55	44	38	39	59	63	62	49	42	43	59	63	65	52	45	46					
	14 x 10	2700	1274	0.10	25	69	62	57	53	46	43	75	68	64	57	51	50	80	73	69	61	55	54	83	76	72	64	59	58	85	79	74	66	61	60					
		1950	920	0.05	12	61	53	49	43	36	32	71	64	60	52	46	44	76	69	65	57	52	50	80	73	69	61	56	54	81	75	70	63	58	56					
		1550	731	0.03	7	56	47	43	38	30	23	69	61	58	50	43	41	74	66	62	55	49	47	78	70	66	59	54	52	79	73	69	61	56	55					
		1050	495	0.01	2	-	41	36	30	25	-	65	57	53	46	39	37	70	63	59	52	47	44	73	67	64	55	50	51	75	69	65	57	50	52					
		525	248	0.01	2	-	-	32	29	25	-	58	50	46	40	33	28	61	56	52	44	39	37	63	60	56	48	43	42	64	62	60	51	45	46					

For performance table notes, see page C155; highlighted numbers indicate embedded AHRI certification points.

FAN POWERED TERMINAL UNITS

Performance Data • Radiated Sound Power Levels Model Series 37N • Parallel Flow • 100% Primary Air • Cooling Cycle Fiberglass Liner



Unit Size	Inlet Size	Airflow		Min. inlet ΔPs		Fan and 100% Primary Air – Sound Power Octave Bands @ Inlet pressure (ΔPs) shown																																		
						Minimum ΔPs							0.5" w.g. (125Pa) ΔPs							1.0" w.g. (249Pa) ΔPs							1.5" w.g. (375Pa) ΔPs							2.0" w.g. (500Pa) ΔPs						
						2	3	4	5	6	7	2	3	4	5	6	7	2	3	4	5	6	7	2	3	4	5	6	7	2	3	4	5	6	7					
2	6	450	212	0.19	47	55	48	40	36	32	25	62	53	46	40	35	31	67	59	52	43	36	32	70	63	56	46	38	35	71	65	58	48	39	37					
		400	189	0.16	40	52	45	38	35	31	-	60	51	44	38	33	25	67	58	51	42	35	30	69	62	55	45	37	34	70	64	57	46	38	36					
		300	142	0.10	25	-	-	36	34	32	-	59	49	42	36	33	-	64	55	48	40	35	27	66	58	52	42	35	31	67	61	55	44	37	35					
		200	94	0.05	12	-	-	33	31	29	-	55	46	40	36	34	-	60	52	46	38	35	26	59	54	50	40	36	31	59	55	52	41	35	33					
		100	47	0.02	5	-	-	29	26	-	-	-	40	35	29	-	-	-	44	41	31	26	-	-	45	45	34	29	27	-	46	45	36	31	31					
	8	800	378	0.11	27	56	46	39	37	36	27	65	54	46	42	39	32	72	59	51	44	41	35	74	63	55	45	41	35	73	65	57	47	42	37					
		700	330	0.08	20	56	44	38	36	36	26	65	52	45	40	38	30	71	59	50	43	40	32	72	62	54	44	40	34	73	63	56	45	41	35					
		600	283	0.06	15	52	41	36	34	36	25	63	50	43	38	38	29	69	55	48	40	38	31	70	59	52	42	39	33	70	61	53	44	40	34					
		400	189	0.03	7	50	39	35	33	34	23	59	47	40	36	37	27	63	51	44	37	37	28	63	53	48	39	37	31	63	55	50	41	37	32					
		175	83	0.01	2	-	-	33	30	25	-	49	43	38	32	22	-	52	45	42	33	31	22	53	47	47	37	33	25	54	47	49	40	33	27					
	10	1400	661	0.27	67	64	54	47	43	45	38	65	55	48	43	44	37	71	61	53	45	44	37	75	65	57	47	44	39	76	68	59	48	44	40					
		1100	519	0.16	40	57	49	43	41	42	35	64	54	46	41	42	34	69	59	50	43	42	35	73	64	55	45	42	37	74	66	57	46	42	38					
		825	389	0.09	22	50	44	38	38	41	32	61	52	44	40	41	32	68	57	49	41	40	33	70	60	52	42	39	35	71	62	54	44	39	36					
		550	260	0.04	10	-	42	38	38	39	31	59	50	42	39	40	31	64	53	45	39	38	31	65	56	48	40	38	32	67	58	51	42	39	34					
		275	130	0.01	2	-	41	35	37	37	25	54	46	39	38	38	27	58	49	42	38	37	28	61	52	45	39	37	30	62	54	46	40	38	33					
3	8	800	378	0.14	35	57	48	43	37	31	26	64	53	46	41	34	29	69	57	50	43	37	33	71	60	53	44	39	36	72	63	55	46	41	37					
		700	330	0.10	25	52	46	42	36	29	22	61	51	45	38	31	26	67	55	48	41	35	31	69	59	52	43	37	35	70	61	54	45	39	37					
		600	283	0.07	17	-	44	41	34	28	20	59	49	43	37	30	24	65	54	47	39	33	30	67	57	50	41	36	33	68	59	52	43	38	36					
		400	189	0.03	7	-	41	41	34	27	18	53	46	41	34	28	21	59	50	44	36	30	27	60	52	47	38	32	31	62	53	49	41	34	32					
		175	83	0.01	2	-	41	42	37	30	19	-	44	41	33	28	19	-	46	44	33	27	22	-	47	47	37	30	27	-	47	50	41	32	30					
	10	1400	661	0.30	75	64	54	49	43	40	35	68	58	51	44	41	37	72	63	56	47	42	39	75	68	60	50	44	42	77	69	62	52	46	44					
		1100	519	0.17	42	58	48	46	40	34	27	65	55	49	43	36	32	69	61	54	46	39	35	72	65	58	48	41	39	74	67	60	50	42	40					
		825	389	0.09	22	-	45	44	38	28	18	62	53	48	41	33	26	66	58	51	43	36	31	69	62	54	45	37	36	70	63	56	46	39	38					
		550	260	0.04	10	-	43	43	36	25	-	58	50	45	38	30	21	62	54	47	39	32	29	64	57	50	41	34	33	65	58	51	42	35	35					
		275	130	0.01	2	-	42	42	36	26	-	52	46	43	35	28	19	54	48	45	37	28	22	57	51	48	40	31	26	58	53	50	42	34	30					
	14 x 8	2100	991	0.30	75	63	54	51	46	40	36	68	58	53	48	43	39	72	63	56	51	47	45	76	68	59	53	49	48	78	69	60	55	51	50					
		1600	755	0.17	42	56	50	47	41	34	28	66	55	49	44	39	36	71	60	52	47	44	42	74	63	55	49	47	46	75	65	57	51	49	49					
		1200	566	0.10	25	52	46	44	37	28	17	64	51	45	40	37	36	68	56	49	44	42	41	70	60	52	46	46	45	72	62	55	48	48	48					
		800	378	0.04	10	-	43	43	34	25	-	57	47	42	37	35	35	63	53	46	41	41	41	65	57	49	44	45	45	66	59	53	46	47	47					
		400	189	0.01	2	-	39	42	35	27	-	-	45	41	35	33	35	56	52	46	39	40	40	57	56	52	43	44	44	56	55	54	46	46	47					
4	14 x 8	2100	991	0.08	20	61	53	50	45	40	35	69	59	54	49	44	40	72	62	57	51	47	44	75	65	59	53	49	47	77	67	61	55	52	50					
		1600	755	0.04	10	56	45	44	38	32	26	66	54	49	44	40	36	70	59	53	48	44	41	74	62	56	50	47	46	76	64	58	52	49	49					
		1200	566	0.02	5	50	41	38	32	27	17	61	50	46	41	36	32	66	56	50	45	42	40	69	59	53	47	45	47	70	62	56	49	47	50					
		800	378	0.01	2	-	-	34	27	24	-	56	46	42	37	32	27	62	52	46	40	37	34	63	56	50	44	41	39	64	58	52	46	43	42					
		400	189	0.01	2	-	-	34	27	21	-	49	41	38	32	28	22	53	49	44	36	32	30	55	54	52	42	37	36	54	53	54	45	40	39					
	14 x 10	2700	1274	0.10	25	62	55	52	47	44	36	69	61	56	50	47	42	74	65	60	54	51	48	78	68	62	56	53	50	81	71	64	58	55	55					
		1950	920	0.05	12	54	48	45	39	35	26	66	56	51	45	41	37	71	60	54	48	45	41	76	64	57	51	48	46	78	67	60	53	50	48					
		1550	731	0.03	7	52	44	41	35	31	23	63	53	49	44	40	35	69	58	52	47	45	42	73	62	56	50	48	47	75	65	59	53	51	51					
		1050	495	0.01	2	-	43	37	32	28	18	59	49	45	41	38	35	65	54	49	44	43	44	69	59	53	47	45	47	71	62	56	50	48	49					
		525	248	0.01	2	-	40	36	30	25	-	52	45	40	37	35	32	57	49	44	41	40	39	59	53	50	45	44	43	60	55	52	47	46	46					

For performance table notes, see page C155; highlighted numbers indicate embedded AHRI certification points.

Performance Data • NC Level Application Guide

Model Series 37N • Parallel Flow • Fan Only • Heating Cycle
Fiberglass Liner

PSC Motor

Unit Size	Inlet Size	Airflow		Discharge ΔPs		NC Level	
		cfm	l/s	"w.g.	Pa	Discharge	Radiated
2	ALL	700	330	0.25	62	23	34
		550	259	0.25	62	24	34
		400	189	0.25	62	-	31
		250	118	0.25	62	-	26
3	ALL	850	401	0.25	62	26	38
		700	330	0.25	62	25	35
		550	259	0.25	62	24	32
		350	165	0.25	62	-	28
4	ALL	1350	637	0.25	62	33	45
		1100	519	0.25	62	28	41
		825	389	0.25	62	21	36
		450	212	0.25	62	-	31

Performance Notes:

1. NC Levels are calculated based on procedures as outlined on page C160.
2. Dash (-) in space indicates a NC less than 20.

Performance Data • Sound Power Levels

Model Series 37N • Low Profile • Parallel Flow • Fan Only • Heating Cycle
Fiberglass Liner

PSC Motor

Unit Size	Inlet Size	Airflow		Discharge ΔPs		Sound Power Octave Bands													
		cfm	l/s	"w.g.	Pa	Discharge							Radiated						
						2	3	4	5	6	7	2	3	4	5	6	7		
2	ALL	700	330	0.25	62	68	64	60	55	46	48	67	60	59	54	49	42		
		550	260	0.25	62	70	60	56	51	41	43	69	59	56	50	46	38		
		400	189	0.25	62	61	57	54	47	37	38	63	57	56	48	44	36		
		250	118	0.25	62	-	53	49	41	30	26	59	54	52	43	38	29		
3	ALL	850	401	0.25	62	74	65	63	58	52	55	72	65	63	59	51	43		
		700	330	0.25	62	71	61	60	54	47	50	68	60	60	55	47	38		
		550	260	0.25	62	70	56	56	50	42	45	67	57	57	51	43	33		
		350	165	0.25	62	66	52	51	44	36	35	62	53	53	46	38	26		
4	ALL	1350	637	0.25	62	79	71	70	68	62	63	77	72	69	66	59	51		
		1100	519	0.25	62	75	66	67	62	56	57	73	67	66	62	54	46		
		825	389	0.25	62	70	60	62	56	49	50	69	61	61	56	47	39		
		450	212	0.25	62	63	52	53	46	38	36	64	55	56	49	40	30		



For performance table notes, see page C155; highlighted numbers indicate embedded AHRI certification points.

Performance Data • AHRI Certification and Performance Notes

Model Series 37N • Low Profile • Parallel Flow • AHRI Certification Rating Points

Fiberglass Liner

Unit Size	Inlet Size	Primary Airflow		Min. Inlet ΔPs		100% Primary @ 1.5" w.g. (375 Pa) ΔPs w/ .25" w.g. (62 Pa) Discharge ΔPs														Fan Airflow	Fan† Watts	Fan Only* @ 25" w.g. (62 Pa) ΔPs													
						Discharge							Radiated									Discharge							Radiated						
						2	3	4	5	6	7	2	3	4	5	6	7	2	3			4	5	6	7	2	3	4	5	6	7				
2	10	1100	519	0.16	40	75	72	66	57	50	45	73	64	55	45	42	37	550	260	275	70	60	56	51	41	43	69	59	56	50	46	38			
3	14 x 8	1600	755	0.17	42	78	73	66	59	51	51	74	63	55	49	47	46	700	330	355	71	61	60	54	47	50	68	60	60	55	47	38			
4	14 x 10	1950	920	0.05	12	80	73	69	61	56	54	76	64	57	51	48	46	1100	519	570	75	66	67	62	56	57	73	67	66	62	54	46			

Motor = PSC

* Primary air valve is closed and therefore primary cfm is zero.



Ratings are certified in accordance with AHRI Standards.

Performance Notes for Sound Power Levels:

- Discharge sound power is the noise emitted from the unit discharge into the downstream duct. Discharge Sound Power Levels (SWL) now include duct end reflection energy as part of the standard rating. Including the duct end correction provides sound power levels that would normally be transmitted into an acoustically, non-reflective duct. The effect of including the energy correction to the discharge SWL, is higher sound power levels when compared to previous AHRI certified data. For more information on duct end reflection calculations see AHRI Standard 880.
- Radiated sound power is the breakout noise transmitted through the unit casing walls.
- Sound power levels are in decibels, dB re 10⁻¹² watts.
- All sound data listed by octave bands is raw data without any corrections for room absorption or duct attenuation. Dash (-) in space indicates sound power level is less than 20 dB or equal to background.
- Minimum inlet ΔPs is the minimum operating pressure requirement of the unit (damper full open) to achieve rated primary CFM.
- Asterisk (*) in space indicates that the minimum inlet static pressure requirement is greater than 0.5" w.g. (125 Pa) at rated airflow.
- Data derived from independent tests conducted in accordance with ANSI/ASHRAE Standard 130 and AHRI Standard 880.
- 100% primary air sound power levels are cooling cycle (fan turned off).
- Fan airflow is rated fan volume at .25" w.g. (62 Pa) downstream static pressure.
- Fan only sound power levels are 100% recirculated air; fan only; in heating cycle.
- Fan Watts are the maximum electrical power input at rated fan volume.

Performance Data • Hot Water Coil

Model: 37NW • Parallel Flow • Low Profile

Unit Size 2

1 Row (single circuit)

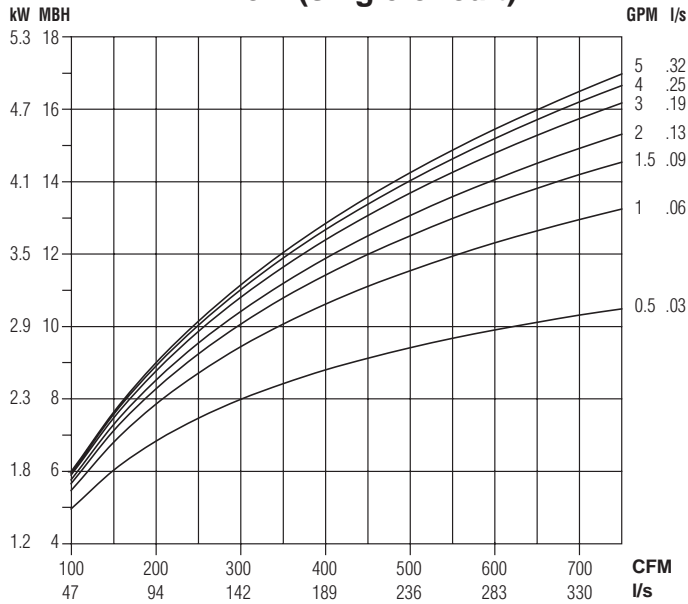

2 Row (multi-circuit)

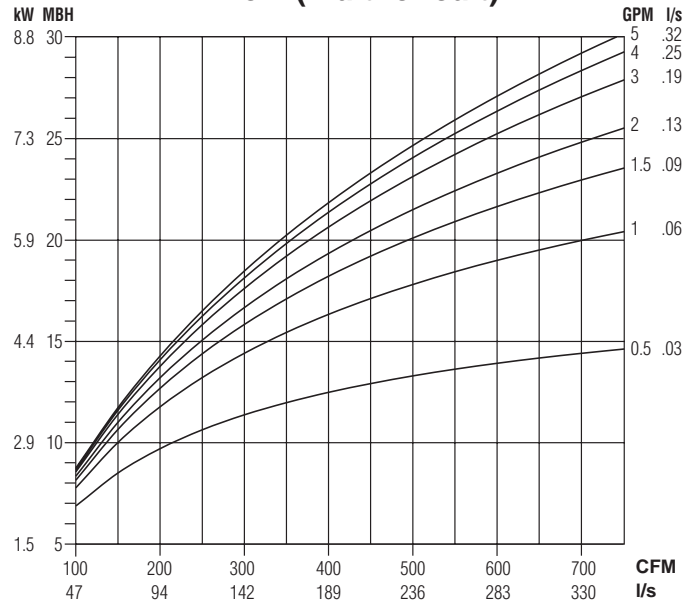

Water Pressure Drop

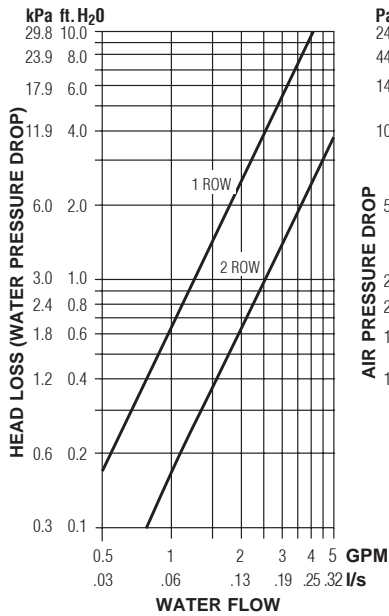

Air Pressure Drop

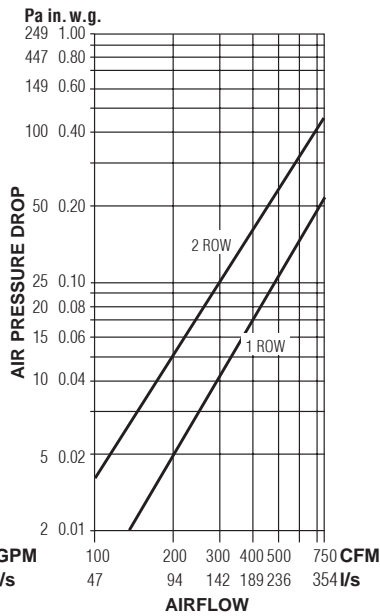

NOTES:

- Capacities are in MBH (kW), **thousands of Btu per hour (kiloWatts)**.
- MBH (kW) values are based on a Δt (temperature difference) of 110°F (61°C) between entering air and entering water. For other Δt 's; multiply the MBH (kW) values by the factors below.

- Air Temperature Rise.
 $ATR (^\circ F) = 927 \times \frac{MBH}{cfm}$, $ATR (^\circ C) = 829 \times \frac{kW}{I/s}$
- Water Temp. Drop.
 $WTD (^\circ F) = 2.04 \times \frac{MBH}{GPM}$, $WTD (^\circ C) = .224 \times \frac{kW}{I/s}$
- Connections: 1 Row 1/2" (13) and 2 Row 7/8" (22); O.D. male solder.

Altitude Correction Factors:

Altitude ft. (m)	Sensible Heat Factor
0 (0)	1.00
2000 (610)	0.94
3000 (914)	0.90
4000 (1219)	0.87
5000 (1524)	0.84
6000 (1829)	0.81
7000 (2134)	0.78

Correction factors at other entering conditions:

Δt °F (°C)	50 (28)	60 (33)	70 (39)	80 (44)	90 (50)	100 (56)	110 (61)	120 (67)	130 (72)	140 (78)	150 (83)
Factor	.455 (.459)	.545 (.541)	.636 (.639)	.727 (.721)	.818 (.820)	.909 (.918)	1.00 (1.00)	1.09 (1.10)	1.18 (1.18)	1.27 (1.28)	1.36 (1.36)

Performance Data • Hot Water Coil Model: 37NW • Parallel Flow • Low Profile

Unit Size 3

1 Row (single circuit)

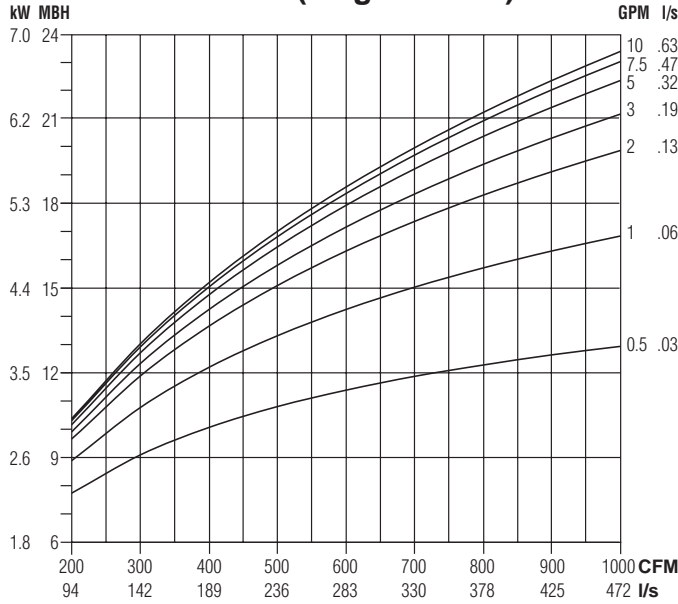

2 Row (multi-circuit)

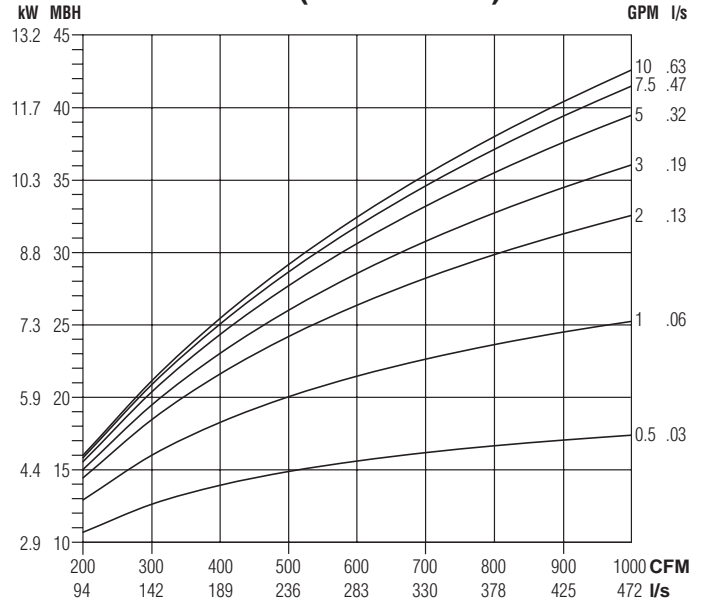

Water Pressure Drop

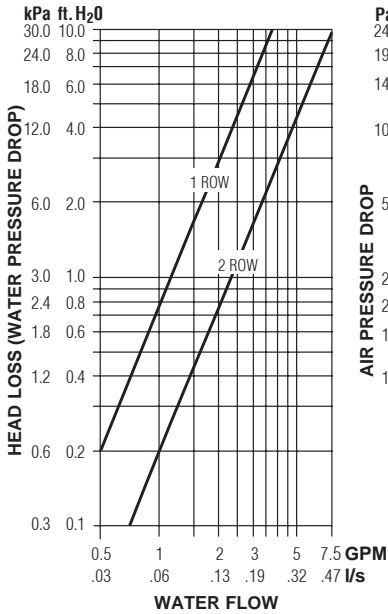

Air Pressure Drop

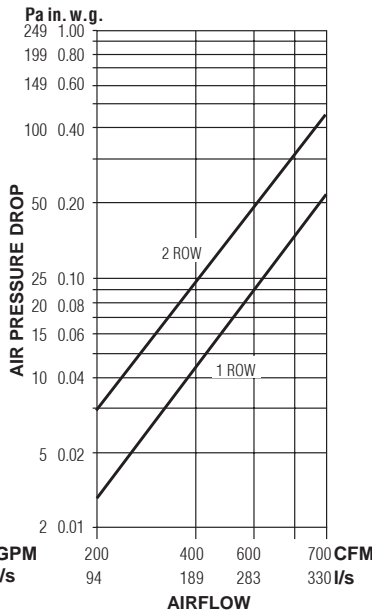

NOTES:

- Capacities are in MBH (kW), **thousands of Btu per hour (kiloWatts)**.
- MBH (kW) values are based on a Δt (temperature difference) of 110°F (61°C) between entering air and entering water. For other Δt 's; multiply the MBH (kW) values by the factors below.
- Air Temperature Rise.
 $ATR (^{\circ}F) = 927 \times \frac{MBH}{cfm}$, $ATR (^{\circ}C) = 829 \times \frac{kW}{l/s}$
- Water Temp. Drop.
 $WTD (^{\circ}F) = 2.04 \times \frac{MBH}{GPM}$, $WTD (^{\circ}C) = .224 \times \frac{kW}{l/s}$
- Connections: 1 Row 1/2" (13) and 2 Row 7/8" (22); O.D. male solder.

Altitude Correction Factors:

Altitude ft. (m)	Sensible Heat Factor
0 (0)	1.00
2000 (610)	0.94
3000 (914)	0.90
4000 (1219)	0.87
5000 (1524)	0.84
6000 (1829)	0.81
7000 (2134)	0.78

Correction factors at other entering conditions:

Δt °F (°C)	50 (28)	60 (33)	70 (39)	80 (44)	90 (50)	100 (56)	110 (61)	120 (67)	130 (72)	140 (78)	150 (83)
Factor	.455 (.459)	.545 (.541)	.636 (.639)	.727 (.721)	.818 (.820)	.909 (.918)	1.00 (1.00)	1.09 (1.10)	1.18 (1.18)	1.27 (1.28)	1.36 (1.36)

Performance Data • Hot Water Coil

Model: 37NW • Parallel Flow • Low Profile

Unit Size 4

1 Row (single circuit)

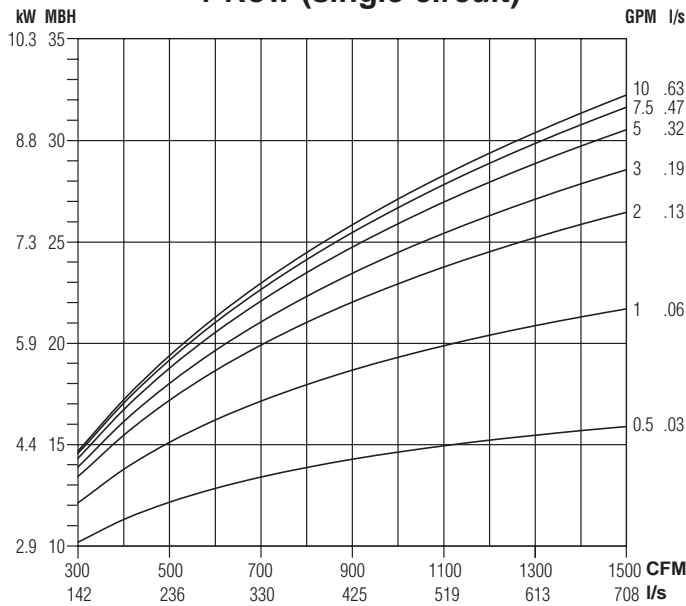

2 Row (multi-circuit)

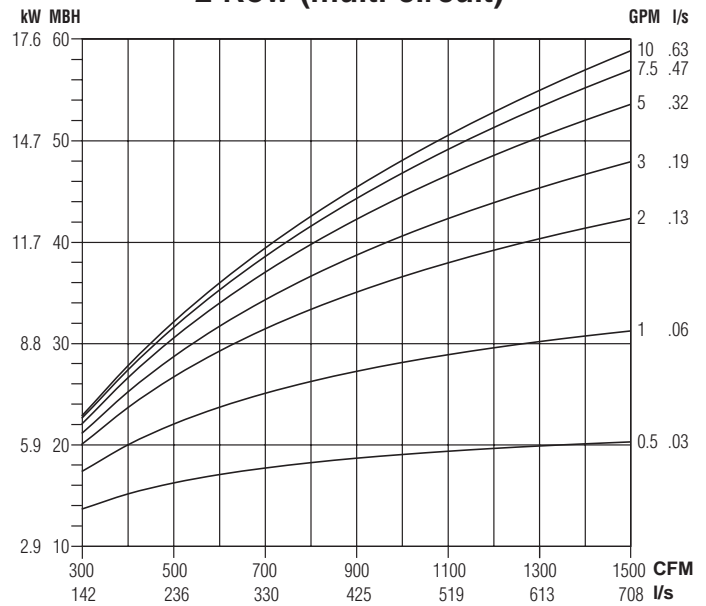

Water Pressure Drop

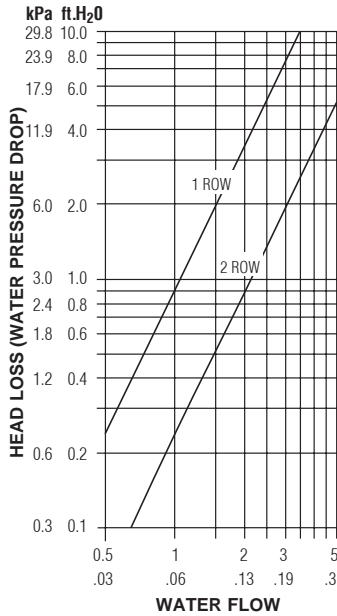

Air Pressure Drop

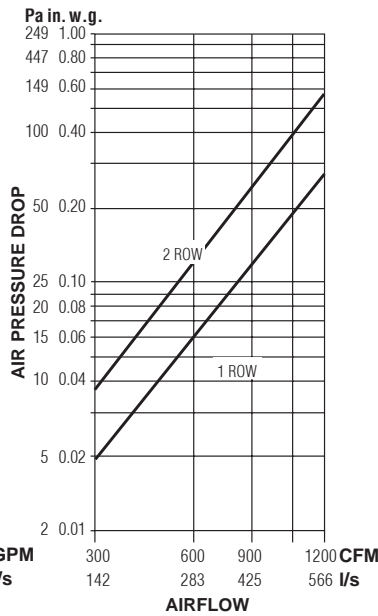

NOTES:

- Capacities are in MBH (kW), *thousands of Btu per hour (kiloWatts)*.
- MBH (kW) values are based on a Δt (temperature difference) of 110°F (61°C) between entering air and entering water. For other Δt's; multiply the MBH (kW) values by the factors below.

- Air Temperature Rise.
 $ATR (°F) = 927 \times \frac{MBH}{cfm}$, $ATR (°C) = 829 \times \frac{kW}{l/s}$
- Water Temp. Drop.
 $WTD (°F) = 2.04 \times \frac{MBH}{GPM}$, $WTD (°C) = .224 \times \frac{kW}{l/s}$
- Connections: 1 Row 1/2" (13) and 2 Row 7/8" (22); O.D. male solder.

Altitude Correction Factors:

Altitude ft. (m)	Sensible Heat Factor
0 (0)	1.00
2000 (610)	0.94
3000 (914)	0.90
4000 (1219)	0.87
5000 (1524)	0.84
6000 (1829)	0.81
7000 (2134)	0.78

Correction factors at other entering conditions:

Δt °F (°C)	50 (28)	60 (33)	70 (39)	80 (44)	90 (50)	100 (56)	110 (61)	120 (67)	130 (72)	140 (78)	150 (83)
Factor	.455 (.459)	.545 (.541)	.636 (.639)	.727 (.721)	.818 (.820)	.909 (.918)	1.00 (1.00)	1.09 (1.10)	1.18 (1.18)	1.27 (1.28)	1.36 (1.36)

Performance Data Explanation

Sound Power Levels vs. NC Levels

The **Nailor Model Series: 35S, 35SST, 37S, 37SST, 35N and 37N** fan powered terminal unit performance data is presented in two forms.

The laboratory obtained discharge and radiated sound power levels in octave bands 2 through 7 (125 through 4000 Hz) center frequency for each unit size at various flow rates and inlet static pressures is presented. This data is derived in accordance with ANSI/ASHRAE Standard 130 and AHRI Standard 880. This data is raw with no attenuation deductions and includes AHRI Certification standard rating points.

Nailor also provides an "NC Level" table as an application aid in terminal selection, which include attenuation allowances as explained below. The suggested attenuation allowances are typical and are not representative of specific job site conditions. It is recommended that the sound power level data be used and a detailed NC calculation be performed using the procedures outlined in AHRI Standard 885, Appendix E for accurate space sound levels.

Explanation of NC Levels

Tabulated NC levels are based on attenuation values as outlined in AHRI Standard 885 Procedure for Estimating Occupied Space Sound Levels in the Application of Air Terminals and Air Outlets". AHRI Standard 885, Appendix E provides typical sound attenuation values for air terminal discharge sound and air terminal radiated sound.

As stated in AHRI Standard 885, Appendix E, These values can be used as a quick method of estimating space sound levels when a detailed evaluation is not available. The attenuation values are required for use by manufacturers to catalog application sound levels. In product catalogs, the end user environments are not known and the following factors are provided as typical attenuation values. Use of these values will allow better comparison between manufacturers and give the end user a value which will be expected to be applicable for many types of space.

Radiated Sound

Table E1 of Appendix E provides typical radiated sound attenuation values for three types of ceiling: Type 1 – Glass Fiber; Type 2 – Mineral Fiber; Type 3 – Solid Gypsum Board.

Since Mineral Fiber tile ceilings are the most common construction used in commercial buildings, these values have been used to tabulate Radiated NC levels.

The following table provides the calculation method for the radiated sound total attenuation values based on AHRI Standard 885.

	Octave Band					
	2	3	4	5	6	7
Environmental Effect	2	1	0	0	0	0
Ceiling/Space Effect	16	18	20	26	31	36
Total Attenuation Deduction	18	19	20	26	31	36

The ceiling/space effect assumes the following conditions:

1. 5/8" (16) tile, 20 lb/ft³ (320 kg/m³) density.
2. The plenum is at least 3 feet (914) deep.
3. The plenum space is either wide [over 30 feet (9 m)] or lined with insulation.
4. The ceiling has no significant penetration directly under the unit.

Discharge Sound

Table E1 of Appendix E provides typical discharge sound attenuation values for three sizes of terminal unit.

1. Small box; Less than 300 cfm (142 l/s)
[Discharge Duct 8" x 8" (203 x 203)].
2. Medium box; 300 – 700 cfm (142 - 330 l/s)
[Discharge Duct 12" x 12" (305 x 305)].
3. Large box; Greater than 700 cfm (330 l/s)
[Discharge Duct 15" x 15" (381 x 381)].

These attenuation values have been used to tabulate Discharge NC levels applied against the terminal airflow volume and not terminal unit size.

The following tables provide the calculation method for the discharge sound total attenuation values based on AHRI Standard 885.

Small Box <300 cfm	Octave Band					
	2	3	4	5	6	7
Environmental Effect	2	1	0	0	0	0
5 ft. (1.5 m) 1" (25) Duct Lining	2	6	12	25	29	18
Branch Power Division (1 outlet)	0	0	0	0	0	0
5 ft. (1.5 m), 8 in. dia. (203) Flex Duct	5	10	18	19	21	12
End Reflection	10	5	2	1	0	0
Space Effect	5	6	7	8	9	10
Total Attenuation Deduction	24	28	39	53	59	40

Medium Box 300 – 700 cfm	Octave Band					
	2	3	4	5	6	7
Environmental Effect	2	1	0	0	0	0
5 ft. (1.5 m) 1" (25) Duct Lining	2	4	10	20	20	14
Branch Power Division (2 outlets)	3	3	3	3	3	3
5 ft. (1.5 m), 8 in. dia. (203) Flex Duct	5	10	18	19	21	12
End Reflection	10	5	2	1	0	0
Space Effect	5	6	7	8	9	10
Total Attenuation Deduction	27	29	40	51	53	39

Large Box >700 cfm	Octave Band					
	2	3	4	5	6	7
Environmental Effect	2	1	0	0	0	0
5 ft. (1.5 m) 1" (25) Duct Lining	2	3	9	18	17	12
Branch Power Division (3 outlets)	5	5	5	5	5	5
5 ft. (1.5 m), 8 in. dia. (203) Flex Duct	5	10	18	19	21	12
End Reflection	10	5	2	1	0	0
Space Effect	5	6	7	8	9	10
Total Attenuation Deduction	29	30	41	51	52	39

1. Flexible duct is non-metallic with 1" (25) insulation.
2. Space effect (room size and receiver location) 2500 ft.³ (69 m³) and 5 ft. (1.5 m) distance from source.

For a complete explanation of the attenuation factors and the procedures for calculating room NC levels, please refer to the acoustical engineering guidelines at the back of this catalog and AHRI Standard 885.

Electric Heating Coils

Features, Selection and Capacities

Nailor Electric Coils are tested with terminal units in accordance with UL Standard 1995 and meet all requirements of the NEC (National Electric Code) and CSA (Canadian Standards Association). Units are listed and labeled by the ETL Testing Laboratory as a total package. All controls are enclosed in a NEMA 1 electrical enclosure on the side of the fan package for easy access.

All wiring for the motor and heater terminates in the enclosure for single point electrical connection in the field. Each unit is supplied with a wiring diagram. Note: NEC requires a means to disconnect the heater power supply within sight or on the terminal.

Standard Features:

- Automatic reset high limit thermal cut-outs.
- Magnetic contactors per stage on terminals with DDC or analog electronic controls.
- P.E. switch per stage to carry load or pilot duty with magnetic contactors as required with pneumatic control.
- Positive pressure airflow safety switch.
- P.E. switch for fan on parallel terminals (P35NE) with pneumatic control.
- Fan relay for DDC fan terminals.
- Control voltage transformer (Class II) for DDC or analog electronic terminals.
- Class A 80/20 Ni/Cr wire.

Options:

- Toggle disconnect switch.
- Door interlocking disconnect switch.
- Mercury contactors.
- Power circuit fusing.
- Dust tight control enclosure.
- Manual reset high limits.
- SCR Control.

SCR Control Option:

The SCR (Silicon Controlled Rectifier) option provides infinite solid state heater control using a proportional signal (0 – 10 Vdc or 4 – 20 mA). This option may be specified compatible with pneumatic, analog electronic or digital (DDC) controls.

Time proportional control of the electric heater provides superior comfort and energy savings. The SCR controller modulates the heater to supply the exact amount of heat based upon the zone requirement. Room set points are maintained more accurately, undershoot and overshoot as associated with staged heat are eliminated, reducing operation costs.

SCR controllers provide silent operation, as mechanical staged contactors are eliminated. Zero cross switching of the thyristor prevents electrical noise.



Models	Unit Size	Maximum KiloWatts - 1 Stage Heat				
		120 Volt 1 phase	208/240 Volt 1 phase	277 Volt 1 phase	208 Volt 3 phase	480 & 600 Volt 3 phase
33SZE	30	4.5	10*	11.5	14.5	15
	40	4.5	10*	11.5	14.5	18
	50	4.5	10*	11.5	14.5	25
35SE 35SEST	1	–	8	8	10	8
	2	–	8	8	10	8
	3	–	8	11.5	10	14
	4	–	8	11.5	10	16
	5	–	8	11.5	14.5	20.5
	6	–	8	11.5	14.5	26
	7	–	8	11.5	14.5	30
37SE 37SEST	1	–	5.5	5.5	5.5	5.5
	2	–	10.5**	12	12	12
	3	–	10***	12	15.5	17
	4	–	8	11.5	14.5	27
35NE	2	–	8	8	10	8
	3	–	8	11.5	10	14
	5	–	8	11.5	14.5	20.5
	6	–	8	11.5	14.5	26
37NE	2	–	8	11.5	11.5	11.5
	3	–	8	11.5	13.5	16
	4	–	8	11.5	14.5	27

*208V max is 8.5
 **208V max is 9.0
 ***208V max is 8.5

Recommended Selection:

The table above is a quick reference guide, to illustrate the relationship between electrical power supply, heater capacity in kiloWatts and terminal unit size that are available for fan powered units.

- Digital and pneumatic control terminals are available with up to 3 stages of heat. Analog electronic control terminals are available with 1 or 2 stages of heat only. A minimum of 0.5 kW per stage is required.

- Voltage and kilowatt ratings are sized so as not to exceed 48 amps, in order to avoid the NEC code requirement for circuit fusing.

- A minimum airflow of 70 cfm (33 l/s) per kW is required for any given terminal in order to avoid possible nuisance tripping of the thermal cutouts.

- Discharge air temperature should not exceed 120°F (49°C).



Tested and approved to the following standards:
ANSI/UL 1995, 1st ed.
CSA C22.2 No. 236.

Electric Heating Coils (continued)

Application Guidelines

Discharge Air Temperature

When considering the capacity and airflow for the heater, discharge air temperature can be an important factor. Rooms use different types of diffusers and they are intended to perform different functions. Slots that blend the air at the glass and set up air curtains within the room, must be able to blow the air very low in the room. Hot air will be too buoyant to be effective in this case. Discharge air temperatures for this application should be in the 85 – 90°F (29 – 32°C) range.

Diffusers in the center of the room blend their discharge air as it crosses the ceiling. Discharge air temperatures in this application can be as high as 105°F (41°C) and still be effective. However, if the return air grilles are in the discharge air pattern, the warm air will be returned to the plenum before it heats the room. Again, the air temperature needs to be blended down to an acceptable temperature that can be forced down into the occupied space by the time the air gets to the walls. Discharging warm air into the room at temperatures above 105°F (41°C) usually will set up stratification layers and will not keep the occupants warm if there is a ceiling return because only the top 12" – 24" (300 – 600 mm) of the room will be heated.

The maximum approved discharge air temperature for any Nailor Fan Powered Terminal Unit with supplemental heat is 120°F (49°C). No heater should be applied to exceed this temperature.

Electric Heater Selection

To properly select an electric heater, three things must be determined: the heat requirement for the room, the entering air temperature and the desired discharge air temperature. The heat requirement for the room is the sum of the heat loss calculation and the amount of heat required to raise the entering air temperature to the desired room temperature. Usually, the second item is small compared to the first for fan powered terminal units in a return air plenum. MBH can be converted to kW by using the chart or by calculation. There are 3.413 MBH in 1 kW. If using the chart, find the MBH on the left scale, then move horizontally to the right and read kW.

Next, the desired discharge air temperature should be ascertained. This will depend on the type of diffusers that are in the room.

The desired heating airflow for the room can then be calculated using the following equation:

$$cfm = \frac{kW \times 3160}{\Delta t \text{ (discharge air temp - inlet air temp.) } ^\circ F}$$

Assuming 70°F (21°C) supply air temperature to the heater, the room airflow can be selected directly from the chart. Start at the left at the design kW. Move horizontally to the desired discharge air temperature. Then, move vertically down to the cfm at the bottom of the chart.

The kW can be selected directly from the chart. Start at the bottom with the design cfm into the room. Move vertically up to the line that represents the desired discharge air temperature. Then, move left to the kW.

The discharge air temperature can also be selected directly from the chart. Start at the bottom with the design cfm into the room. Move to the left side of the chart and find the design kW. Move horizontally and vertically into the chart until the lines intersect. The intersection will be the desired discharge air temperature. Interpolation between the curves is linear.

Heater Selection Chart

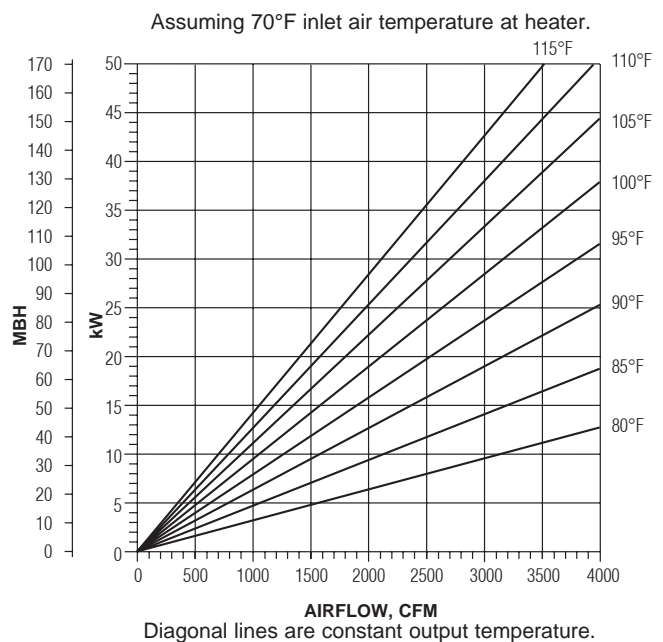

Optional Terminal Unit Liners For IAQ Sensitive Applications

Nailor offers several options for terminal unit applications where the maintenance of an high Indoor Air Quality is a primary concern. Specific IAQ liners are designed to address applications where the issue of fiberglass insulation eroding and entering the airstream is a concern and/or to reduce the risk of microbial growth.

The sound power levels published in this catalog for fan powered terminal units are based upon testing with standard dual density fiberglass insulation. Dual density insulation is surface treated to prevent erosion and was developed to optimize attenuation for terminal unit applications. Cataloged discharge sound levels for series terminals are not significantly affected by the different liner options, as the fan is mounted on the discharge, however radiated sound levels may escalate depending on the terminal model and liner selection. Contact your Nailor representative for further information.

Fiber-Free Liner

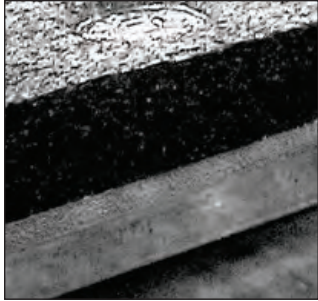

Fiber-Free liner.

Nailor's Fiber-Free liner is 3/4" (19) thick, closed cell elastomeric foam which totally eliminates fiberglass. The liner has excellent thermal insulating characteristics. The foam does not absorb water, reducing the likelihood of mold or bacterial growth.

The Fiber-Free liner surface is smooth, so that dirt and debris won't accumulate, durable, erosion resistant and washable.

Complies with the following standards and tests:

- NFPA 90A Supplementary materials for air distribution systems.
- ASTM E84 and UL 181 (25/50) Smoke and Flame spread.
- ASTM C1071, G21 and G22 (No bacterial or fungal growth).
- Acoustical attenuation of radiated sound is reduced compared with standard dual density fiberglass insulation.

Steri-Liner

Steri-Liner is an internal insulation designed to reduce the risk of microbial growth within the terminal. A smooth non-porous facing provides a vapor barrier to moisture and reduces the risk of micro-organisms becoming trapped. It also facilitates cleaning and prevents insulating material erosion. Damage to the liner though, will expose fiberglass particles to the airstream. Acoustic absorption of aluminum foil lined insulation is reduced for discharge sound levels and somewhat increased for radiated sound levels when compared to standard fiberglass insulation.

- 13/16" (21) thick, 4 lb./sq. ft. (64 kg/m³) density rigid fiberglass with a fire resistant reinforced aluminum foil-scrim-kraft (FSK) facing on all panels in the mixing chamber.
- Meets the requirements of NFPA 90A and UL 181 for smoke and flame spread and the bacteriological requirements of ASTM C665. Will not support the growth of fungi or bacteria, G21 and G22.
- No exposed edges. All Steri-Liner panels feature full length steel angle inserts and end caps to encapsulate the edges. Nailor's Stealth™ models with Steri-Liner are unique and have been especially designed, utilizing a low density foil back insulation with perforated metal covering in the tuned induction port that maintains cataloged radiated sound levels. No other manufacturer can maintain their cataloged sound levels like Nailor with a foil face liner option.

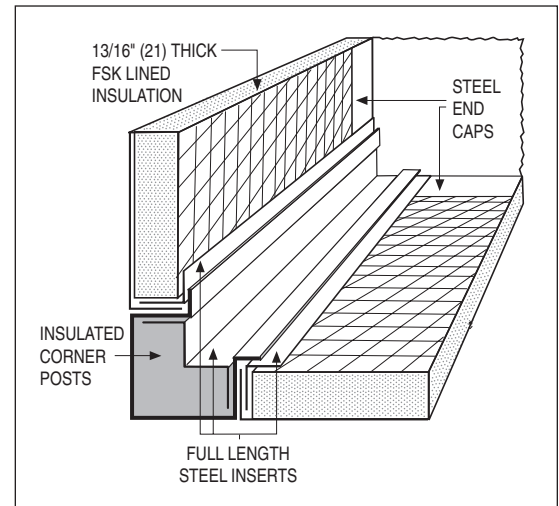

Steri-Liner detail on single duct terminal unit.

Solid Metal Liner

Nailor also offers a solid inner metal liner that completely isolates the standard insulation from the airstream within the terminal mixing chamber. Solid metal liners offer the ultimate protection against exposure of fiberglass particles to the airstream, all but eliminating the possibility of punctures exposing fiberglass. This option is also resistant to moisture. Fully performance tested for our clients, the Stealth™ series terminals with solid metal liner feature the tuned induction attenuation design described above for Steri-Liner and reduce cataloged radiated sound level ratings. No other terminal manufacturer can make that claim.

Perforated Metal Liner

Provides additional security and retains standard dual density fiberglass insulation or optional Steri-Liner insulation reducing possibility of long term erosion or breakdown.

Line Voltage Enclosure Options

- Help ensure NEC clearance requirements

90° Option (Code FN2)

The most universal problem encountered on nearly every job is finding adequate space in the ceiling plenum for mounting the mechanical equipment. That is why Nailor researched at length to develop the narrowest series fan powered terminal units available in the industry today. Making the units narrow, increases the chance that they will physically fit between floor joists or into coffers. Unfortunately, the width of the unit is not the only limiting factor. The National Electrical Code calls for a working clearance in front of the controls enclosure. The required clearance is 36" (914) for 0 – 150 VAC and 42" (1067) for 151 – 600 VAC. It is a common practice to mount the controls enclosure flat against the side of the unit; however, that causes the terminal unit footprint to be effectively 42" (1067) wider in order to meet this NEC clearance requirement.

Nailor offers a unique mounting option for the controls enclosure on several models of the series fan powered terminal units. The enclosure can be mounted at 90° on the discharge end of the basic terminal as shown in the photograph. This FN2 option allows the 42" (1067) clearance requirement to run along the side of the unit or along the discharge duct where there is a good chance of clear areas already. This again serves to keep the equipment narrow to fit in the tightest of locations within the ceiling cavity.

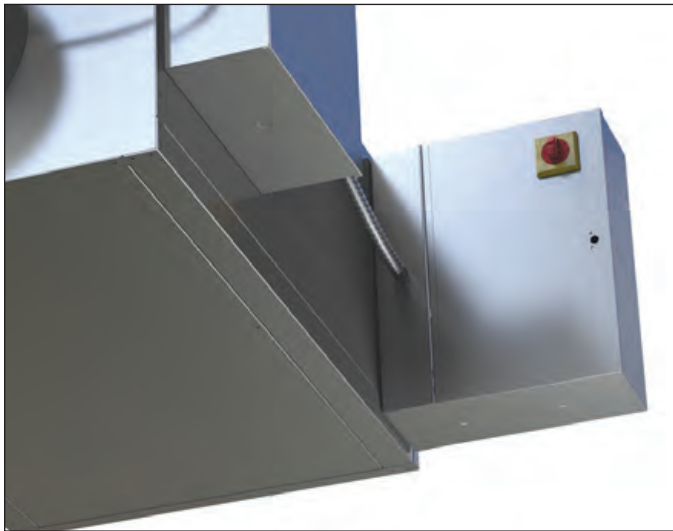

90° Line Voltage Enclosure Option

Remote Option (Code FN3)

The FN3 line voltage enclosure is an ETL listed option. The FN3 was developed for Nailor fan powered terminal units in order to help meet NEC clearance requirements. Standard enclosures are mounted on the side of the unit and effectively add 42" (1067) to the terminals width footprint. Very often there is insufficient clearance in the ceiling plenum due to physical obstructions to accommodate this. The FN3 provides flexibility in that it may be field positioned in any orientation that provides the NEC clearance requirement. The FN3 enclosure is shipped loose with a 48" (1219) flexible conduit connection to the terminal unit.

Low Temperature Construction Option (35S Series)

Nailor offers series flow (constant volume) fan powered terminal units with low temperature construction for applications involving low temperature/cold air distribution systems. The fan powered terminal unit is ideal for use with low temperature primary air 40°–48°F (4°–9°C) supplied to the terminal from chilled water/ice storage systems. These low temperature system designs are feasible where off-peak utility rates encourage their use. For instance, ice can be made at night using cheaper power and then used during occupied hours to produce cold air.

The terminal is designed to both handle the low temperature primary air without condensation and effectively mix the cold supply air with warm induced plenum air, resulting in a uniform discharge air temperature. It is common practice to set the fan airflow higher than the maximum primary airflow setting in order to temper the air when used with conventional diffusers in order to optimize performance and eliminate any risk of dumping.

Construction Features:

- Thermally isolated inlet collar eliminates the risk of condensation forming on the terminal casing inlet.
- Integral perforated mixing baffle on the damper discharge improves mixing efficiency, reduces stratification and improves discharge temperature equalization in the discharge duct.
- Steri-Liner insulation construction provides a foil vapor/thermal barrier, which reduces the risk of moisture damaging the internal insulation and helps eliminate condensation forming on the outside of the terminal unit, which could cause damage in the ceiling space.

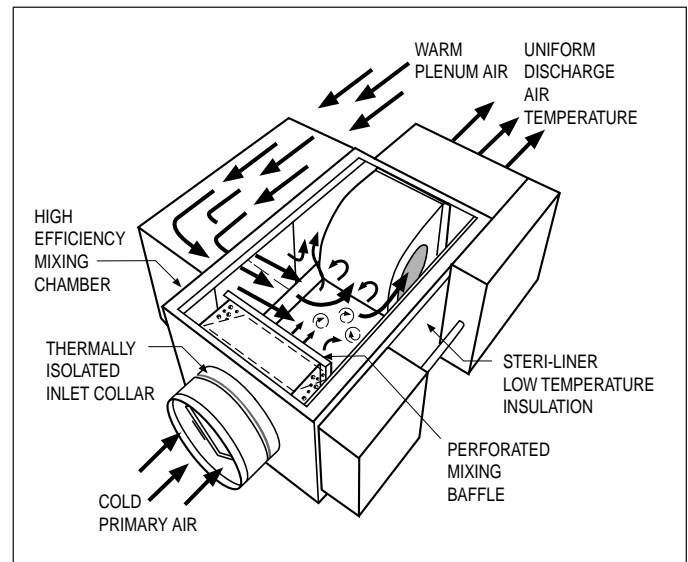

RETROFIT TERMINAL UNITS

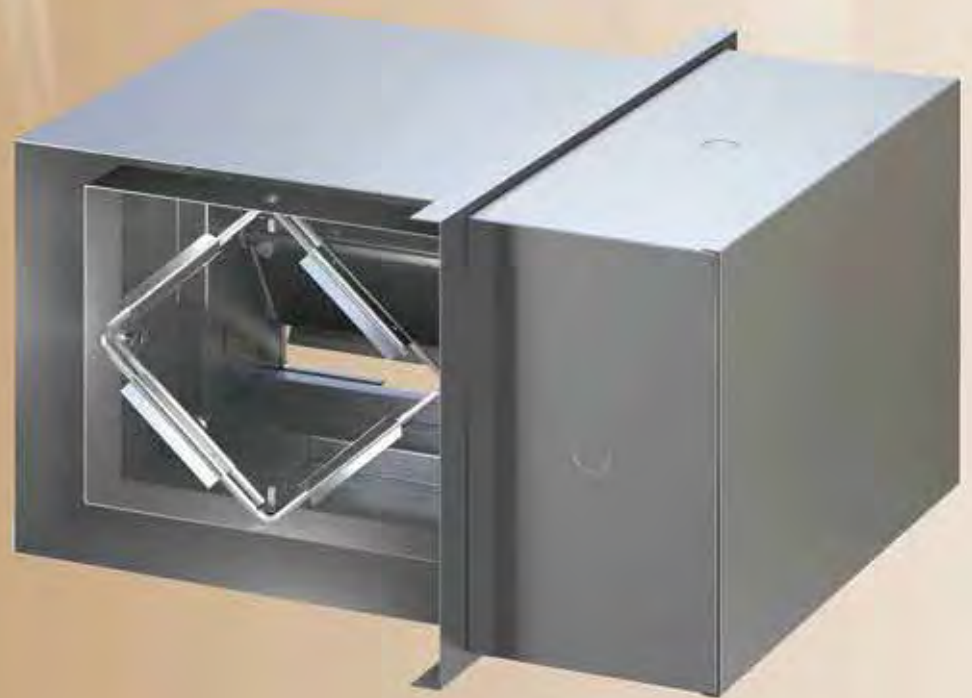

TABLE OF CONTENTS

	Page No.
Product Overview	D3
Applications	D4
Model 36VRR • Round External Duct	
Features, Options and Dimensional Data	D5
Recommended Airflow Ranges	D6
Performance Data	D7
Model 36VRS • Slide-in Rectangular or Square	
Features, Options and Dimensional Data	D10
Recommended Airflow Ranges	D11
Performance Data	D12
Models 36FMI, 36FMS and 36FMSD • Round Duct Flow Measuring Stations	
Features and Dimensional Data	D14

GENERAL PRODUCT OVERVIEW

Retrofit Terminal Units

- Convert Constant Air Volume Systems to Variable Air Volume.
 - Convert Constant Volume Dual Duct Systems to Variable Air Volume.
 - Convert Multizone Systems to Variable Air Volume.
 - Convert Mechanical Constant Volume Regulators to Low Pressure Digital, Analog Electronic or Pneumatic Controls.
- Nailor manufactures a range of standard and custom design retrofit terminal units for all applications.

Round Duct External Retrofit Terminal Unit

Convert existing constant volume systems or old "system powered" mechanical regulator terminals to energy efficient variable volume operation.

- Available in 10 sizes to suit and install simply in round ductwork. 0 – 4050 cfm (0 – 1911 l/s).
- Various configurations custom fabricated to suit individual applications.
- Pressure dependent or independent airflow control.
- Diamond Flow multi-point averaging flow sensor on pressure independent models.
- Digital, electric, analog electronic or pneumatic control.

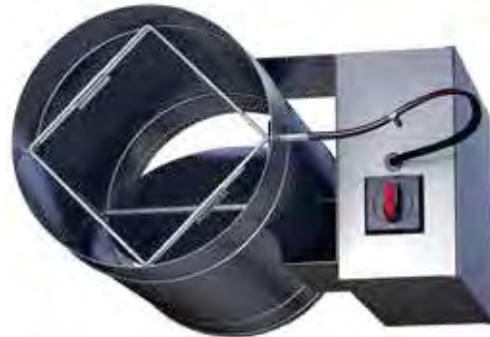

Model 36VRR

Model 36VRR

See page D5



Model 36VRS

Rectangular Slide-in Retrofit Terminal Unit

Convert existing constant volume systems to energy efficient variable volume operation.

- Available in 15 valve sizes to handle a large range of air volumes. 0 – 15000 cfm (0 – 7079 l/s).
- Custom fabricated to suit any duct size from 5" x 5" (127 x 127) up to 52" x 26" (1321 x 660).
- Diamond Flow multi-point averaging sensor.
- Pressure independent airflow control.
- Digital, analog electronic or pneumatic control.

Model 36VRS

See Page D10

Internal Retrofit Terminal Units

Designed to replace the mechanical regulators in old system powered terminal units in order to substantially lower the operational static pressure requirement. The air valves include a damper, flow sensor and actuator and make use of state-of-the-art controls in order to reduce operating cost.

- Custom built on a specific project basis.
- Variable or constant volume pressure independent airflow control.
- Diamond Flow multi-point averaging flow sensor.
- Models available to retrofit most brand name mechanical regulator design terminal units.
- Digital, analog electronic or pneumatic control.

Model 36VRTR

Contact your Nailor Sales Rep.

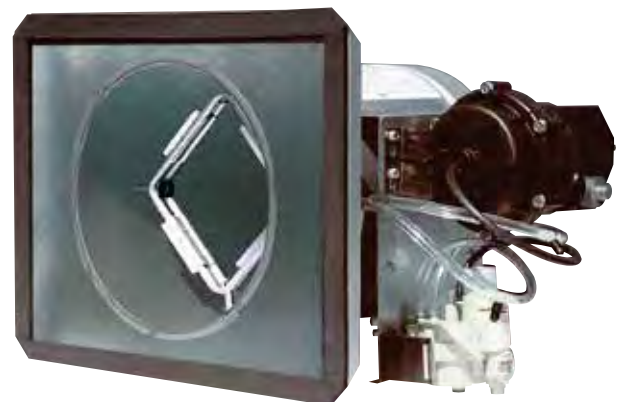

Model 36VRTR

Some Typical Applications for the Model Series 36VR Retrofit Terminal Units

Dual Duct System

Hot and cold air from the central station is distributed through the existing supply ducts and terminals. The **Series 36VR Retrofit Terminals** will convert the constant volume system to variable air volume pressure independent operation.

Remove the mechanical constant volume regulator from the existing terminal, while a **Model 36VRS** is installed in the discharge box or duct. A direct acting thermostat controls both the **36VRS** unit and the modulating tandem damper in the existing box. On a rise in room temperature, the **36VRS** reduces the hot airflow. At the minimum setting, the damper in the existing terminal begins to modulate, and mixing occurs. A further temperature rise increases the cold airflow to the maximum.

The fan capacity may be reduced down since the total air volume is reduced.

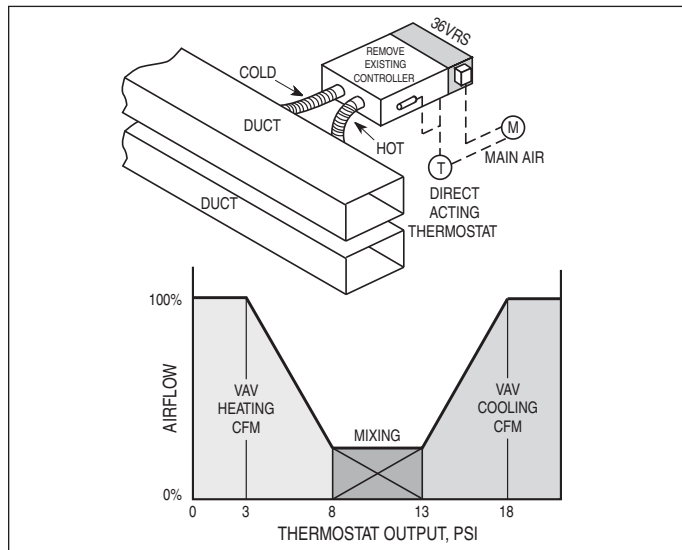

Constant Volume Reheat System

Cold air from the central station is distributed through the existing main trunk and branch ducts. The **Model 36VRS Retrofit Terminals** will convert the constant volume system to pressure independent variable air volume operation.

Each **36VRS** terminal is signaled by a direct acting thermostat. The pressure independent minimum airflow is set at a thermostat output pressure of 8 psi or less, while the maximum is set at 13 psi or greater.

The existing reheat coil in each zone is actuated on a fall in room temperature, as the thermostat output decreases from 8 to 3 psi.

The fan capacity must be reduced since the total air volume is reduced.

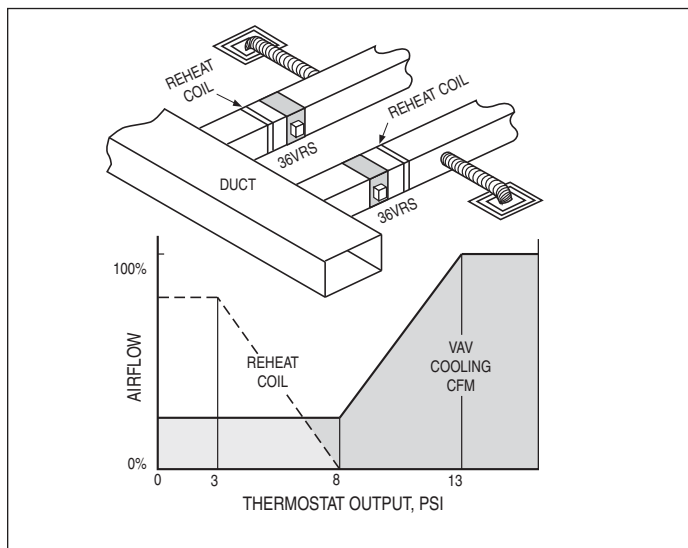

Multizone System

Hot or cold air from the central station multizone air handler is distributed through the existing zone system. The **Series 36VR Retrofit Terminals** will convert the multizone system to variable air volume operation.

The zone dampers in the central station air handler are made with two-position actuators; each zone is fully open, either heating or cooling. There is no mixing. (Controls may be selected for an outdoor thermostat, a manual selector or changeover signal.)

A dual function thermostat in each zone is direct acting for cooling, reverse acting for heating. In response to the room temperature, the thermostat resets the velocity controller for pressure independent control of the **Series 36VR**.

The fan capacity may be reduced since the total air volume is reduced.

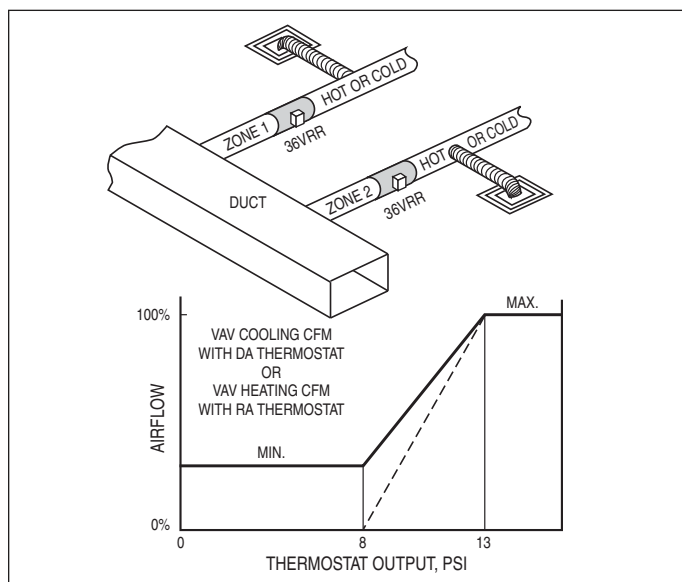

ROUND EXTERNAL DUCT RETROFIT TERMINAL UNITS

MODEL 36VRR

- VARIABLE AIR VOLUME CONVERSION

Model 36VRR is designed for round ductwork retrofit application. Terminals are available in 10 sizes and are nominally undersized to ensure a good fit.

Easy, low-cost installation into existing ductwork. The installer cuts out a section in the round duct and replaces the duct section with the conversion unit.

STANDARD FEATURES:

- Casing 22 ga. (0.86), corrosion-resistant steel with stiffening beads. Sizes 14 and 16 are 20 ga. (1.0).
- Blade: Two layers of 22 ga. (0.86), corrosion-resistant steel laminated together (equivalent to 16 gauge) with a cross-linked polyurethane peripheral gasket for tight shut-off, 90° rotation, CW to close. Damper leakage is less than 1% of terminal rated airflow 3" w.g. (750 Pa) as tested in accordance with ANSI/ASHRAE Standard 130.
- Bearing: Self-lubricating oilite bronze and less than 2% at 6" w.g. (1500 Pa).
- Drive Shaft/Axles: 1/2" (13) diameter plated steel, double-bolted to blades. Indicator mark on the end of the shaft to show damper position.
- Full electrical controls enclosure for factory mounted DDC and analog electronic controls.

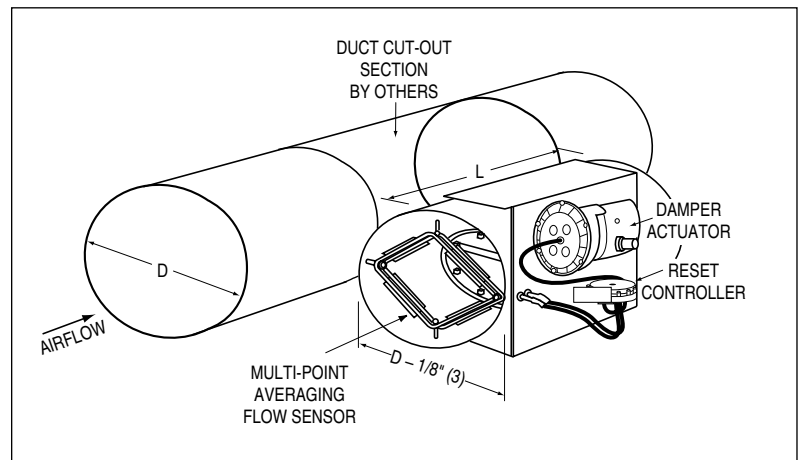

- Multi-point averaging 'Diamond Flow' sensor. Aluminum construction. Gauge taps are provided for field balancing when controls are factory mounted.
- Right-hand control location is standard (as shown). Left-hand is optional.

Options:

- FMI Removable Flow Sensor
- Available in Type 304 and 316 stainless steel construction for laboratory/fume hood exhaust applications.
- Controls enclosure for field mounted controls.
- 24 volt control transformer.
- Toggle disconnect switch.
- Pneumatic or Analog Electronic Pressure Independent controls by Nailor. Factory mounted and calibrated.
- Digital controls by BMS Contractor. Factory mounted by Nailor.

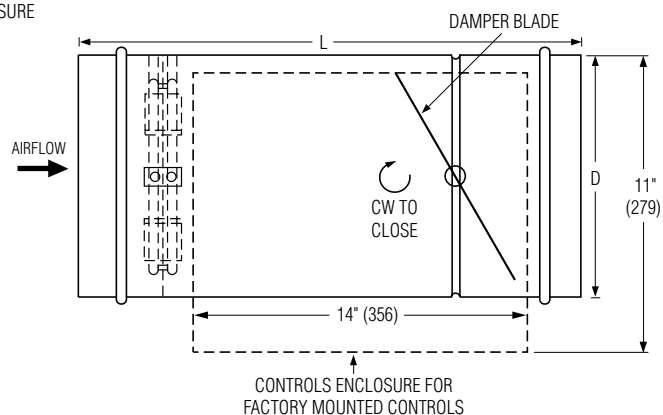
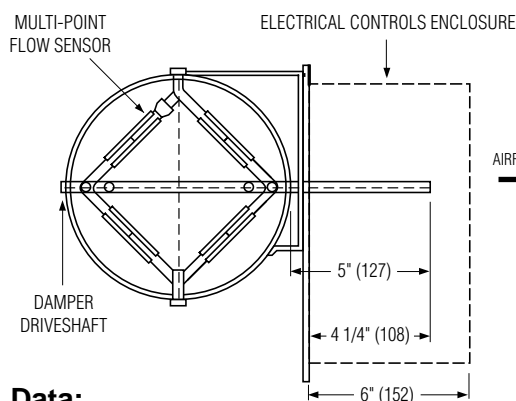

Dimensional Data:

Unit Size	D	L
4	3 7/8 (98)	18 (457)
5	4 7/8 (124)	18 (457)
6	5 7/8 (149)	18 (457)
7	6 7/8 (157)	18 (457)
8	7 7/8 (200)	18 (457)
9	8 7/8 (225)	20 (508)
10	9 7/8 (251)	20 (508)
12	11 7/8 (302)	20 (508)
14	13 7/8 (352)	22 (559)
16	15 7/8 (403)	22 (559)

Recommended Airflow Ranges For Model 36VRR Round Retrofit Terminal Units

The recommended airflow ranges below are for Round Duct Retrofit Terminal Units with pressure independent controls and are presented as ranges for total and controller specific minimum and maximum airflow. Airflow ranges are based upon maintaining reasonable sound levels and controller limits using Nailor's Diamond Flow Sensor as the airflow measuring device. For a given unit size, the minimum, auxiliary minimum (where applicable) and the maximum flow setting must be within the range limits to ensure pressure independent operation, accuracy and repeatability.

Minimum airflow limits are based upon .02" w.g. (5 Pa) differential pressure signal from Diamond Flow Sensor on analog/digital controls and .03" (7.5) for pneumatic controllers. This is a realistic low limit for many transducers used in the digital controls industry. Check with your controls supplier for minimum limits. Setting airflow minimums lower, may cause hunting and failure to meet minimum ventilation requirements. Factory settings will therefore not be made outside these ranges. A minimum setting of zero (shut-off) is also available. Where an auxiliary setting is specified, the value must be greater than the minimum setting.

The high end of the tabulated Total Airflow Range on pneumatic and analog electronic controls represents the Diamond Flow Sensor's differential pressure reading at 1" w.g. (250 Pa). The high end airflow range for digital controls is represented by the indicated transducer differential pressure.



Model 36VRR

ASHRAE 130 "Performance Rating of Air Terminals" is the method of test for the certification program. The "standard rating condition" (certification rating point) airflow volumes for each terminal unit primary valve size are tabulated below per AHRI Standard 880. These air volumes equate to an approximate inlet velocity of 2000 fpm (10.2 m/s).

When digital or other controls are mounted by Nailor, but supplied by others, these values are guidelines only, based upon experience with the majority of controls currently available. Controls supplied by others for factory mounting are configured and calibrated in the field. Airflow settings on pneumatic and analog controls supplied by Nailor are factory preset when provided.

Imperial Units, Cubic Feet per Minute

Unit Size	Inlet Type	Total Airflow Range, cfm	Airflow at 2000 fpm Inlet Velocity (nom.), cfm	Range of Minimum and Maximum Settings, cfm							
				Pneumatic 3000 Controller		Analog Electronic Controls		Digital Controls			
				Transducer Differential Pressure ("w.g.)							
				Min.	Max.	Min.	Max.	Min.	Max.		
4	Round	0 – 225	150	30	180	25	180	25	180	200	225
5		0 – 400	250	55	325	45	325	45	325	350	400
6		0 – 550	400	80	450	65	450	65	450	500	550
7		0 – 800	550	115	650	95	650	95	650	725	800
8		0 – 1100	700	155	900	125	900	125	900	1000	1100
9		0 – 1400	900	200	1150	165	1150	165	1150	1285	1400
10		0 – 1840	1100	260	1500	215	1500	215	1500	1675	1840
12		0 – 2500	1600	350	2050	290	2050	290	2050	2290	2500
14		0 – 3370	2100	475	2750	390	2750	390	2750	3075	3370
16		0 – 4525	2800	640	3700	520	3700	520	3700	4140	4525

Metric Units, Liters per Second

Unit Size	Inlet Type	Total Airflow Range, l/s	Airflow at 10.2 m/s Inlet Velocity (nom.), l/s	Range of Minimum and Maximum Settings, l/s							
				Pneumatic 3000 Controller		Analog Electronic Controls		Digital Controls			
				Transducer Differential Pressure (Pa)							
				Min.	Max.	Min.	Max.	Min.	Max.		
4	Round	0 – 106	71	14	85	12	85	12	85	94	106
5		0 – 189	118	26	153	21	153	21	170	165	189
6		0 – 260	189	38	212	31	212	31	212	236	260
7		0 – 378	260	54	307	45	307	45	342	307	378
8		0 – 579	330	73	425	59	425	59	472	425	579
9		0 – 661	425	94	543	78	543	78	606	495	661
10		0 – 868	519	123	708	101	708	101	790	637	868
12		0 – 1081	755	165	967	137	967	137	1081	1015	1081
14		0 – 1590	991	224	1298	184	1298	184	1451	1444	1590
16		0 – 2135	1321	302	1746	245	1746	245	1954	1911	2135

RETROFIT TERMINAL UNITS

Performance Data • NC Level Application Guide

Model 36VRR

Inlet Size	Airflow		Min. inlet ΔPs		NC Levels @ Inlet Pressure (ΔPs) shown							
					DISCHARGE				RADIATED			
					0.5" w.g. (125 Pa)	1.0" w.g. (250 Pa)	1.5" w.g. (375 Pa)	3.0" w.g. (750 Pa)	0.5" w.g. (125 Pa)	1.0" w.g. (250 Pa)	1.5" w.g. (375 Pa)	3.0" w.g. (750 Pa)
cfm	l/s	"w.g.	Pa									
4	225	106	0.25	62	30	35	39	44	-	21	24	30
	200	94	0.20	50	28	34	38	43	-	-	-	22
	150	71	0.10	25	23	29	33	38	-	-	-	-
	100	47	0.05	12	-	23	26	31	-	-	-	-
5	350	165	0.32	80	26	33	34	41	-	26	26	33
	300	142	0.23	57	24	30	34	39	-	21	23	30
	200	94	0.11	27	20	28	30	38	-	-	-	20
	100	47	0.03	7	-	-	21	28	-	-	-	-
6	450	212	0.22	55	26	31	35	40	20	24	28	32
	400	189	0.18	45	24	30	33	38	-	22	24	30
	300	142	0.10	25	20	25	29	34	-	-	-	23
	200	94	0.04	10	-	23	26	31	-	-	-	-
7	650	307	0.21	52	-	20	24	30	-	26	28	33
	550	260	0.14	35	-	-	20	28	-	22	24	28
	450	212	0.10	25	-	-	-	23	-	-	-	25
	350	165	0.06	15	-	-	-	-	-	-	-	-
8	800	378	0.17	42	23	28	31	38	-	26	26	33
	700	330	0.13	32	23	29	31	38	-	24	24	28
	600	283	0.10	25	21	26	30	35	-	-	21	26
	400	189	0.04	10	-	21	25	30	-	-	-	-
9	1050	496	0.17	42	24	29	33	39	-	25	29	35
	850	401	0.11	27	20	23	29	36	-	21	24	32
	650	307	0.07	17	-	25	29	35	-	-	-	26
	450	212	0.03	7	-	-	24	29	-	-	-	21
10	1350	637	0.16	40	24	30	34	40	21	28	31	36
	1150	543	0.12	30	21	28	31	35	-	24	28	33
	950	448	0.09	22	-	25	29	35	-	20	23	30
	750	354	0.05	12	-	21	24	31	-	-	-	24
12	2100	991	0.19	47	25	33	36	43	29	33	36	40
	1700	802	0.12	30	23	29	33	39	23	29	31	35
	1300	614	0.07	17	-	25	29	35	-	22	25	30
	900	425	0.03	7	-	-	23	30	-	-	-	21
14	3200	1510	0.25	62	28	35	39	45	30	35	38	43
	2700	1274	0.19	47	27	31	35	41	26	31	33	38
	2200	1038	0.12	30	23	28	31	38	21	26	29	34
	1700	802	0.06	15	-	24	28	34	-	21	23	28
16	4000	1888	0.21	52	26	33	36	44	31	36	39	45
	3500	1652	0.15	37	25	31	35	41	29	33	35	41
	3000	1416	0.11	27	23	29	31	38	24	30	32	37
	2000	944	0.04	10	-	23	28	31	-	-	23	28

Performance Notes:

1. NC levels are calculated from the published raw data and based on procedures outlined in AHRI Standard 885, Appendix E.
2. Discharge sound attenuation deductions are based on environmental effect, duct lining, branch power division, insulated flex duct, end reflection and space effect and are as follows:

Discharge attenuation	Octave Band						
	2	3	4	5	6	7	
< 300 cfm	24	28	39	53	59	40	
300 – 700 cfm	27	29	40	51	53	39	
> 700 cfm	29	30	41	51	52	39	

3. Radiated sound attenuation deductions are based on a mineral tile ceiling and environmental effect and are as follows:

Radiation attenuation	Octave Band						
	2	3	4	5	6	7	
Total dB reduction	18	19	20	26	31	36	

4. Min. inlet ΔPs is the minimum static pressure required to achieve rated airflow (damper full open).
5. Dash (–) in space denotes an NC level of less than 20.

Performance Data • Discharge Sound Power Levels

Model 36VRR

Unit Size	Airflow cfm l/s		Min. inlet ΔPs "w.g. Pa		Sound Power Octave Bands Center @ Inlet Pressure ΔPs shown																											
					0.5" w.g. (125 Pa) ΔPs							1.0" w.g. (375 Pa) ΔPs							1.5" w.g. (375 Pa) ΔPs							3.0" w.g. (750 Pa) ΔPs						
					2	3	4	5	6	7	2	3	4	5	6	7	2	3	4	5	6	7	2	3	4	5	6	7				
4	225	106	0.25	62	72	61	56	53	47	45	76	67	65	58	53	51	79	68	65	60	55	56	83	72	71	64	60	62				
	200	94	0.20	50	70	60	55	51	46	44	75	65	60	56	52	50	78	67	63	58	54	54	82	71	67	63	59	60				
	150	71	0.10	25	66	56	51	47	43	43	71	60	56	52	48	45	74	63	59	54	51	50	78	67	63	57	55	55				
	100	47	0.05	12	61	50	47	37	38	38	66	54	51	46	42	40	69	57	54	49	45	46	73	61	59	52	45	48				
5	350	165	0.32	80	72	60	55	53	49	50	77	65	60	56	54	56	78	69	64	59	57	60	84	74	69	64	62	66				
	300	142	0.23	57	70	63	54	51	48	49	75	63	58	54	52	54	78	62	61	57	55	58	82	72	67	62	60	62				
	200	94	0.11	27	64	53	49	46	42	44	70	58	54	50	47	49	72	61	57	52	50	53	78	67	62	57	55	58				
	100	47	0.03	7	58	44	41	37	33	35	62	49	46	41	39	43	65	52	49	44	42	46	70	58	55	48	46	48				
6	450	212	0.22	55	72	60	56	53	52	46	76	65	61	59	57	51	79	68	64	61	59	54	83	73	68	64	63	56				
	400	189	0.18	45	70	58	54	53	51	44	75	63	59	58	56	49	77	72	62	59	57	52	81	71	66	63	61	55				
	300	142	0.10	25	67	54	51	50	46	42	71	59	55	53	51	45	74	62	58	55	53	48	78	66	63	59	57	52				
	200	94	0.04	10	62	48	46	45	42	40	66	53	50	43	46	41	69	56	53	50	48	44	73	61	58	53	53	49				
7	650	307	0.21	52	61	57	57	58	56	49	66	62	61	61	59	53	69	65	64	63	62	58	74	70	68	66	66	62				
	550	260	0.14	35	59	54	54	56	53	47	64	60	60	58	57	51	67	62	63	62	60	56	71	68	66	63	63	60				
	450	212	0.10	25	57	52	52	53	51	45	61	57	56	51	54	48	64	60	59	58	57	54	69	64	64	61	60	56				
	350	165	0.06	15	54	58	49	49	47	40	59	53	53	52	51	45	61	56	56	55	53	50	66	61	60	57	57	54				
8	800	378	0.17	42	71	60	57	57	55	53	75	66	62	61	59	58	78	68	64	63	61	60	83	73	68	66	65	62				
	700	330	0.13	32	69	59	56	56	54	51	74	64	60	59	58	56	76	67	63	62	60	58	81	71	67	65	64	60				
	600	283	0.10	25	68	57	55	53	52	49	72	62	58	57	56	54	75	64	61	59	58	56	79	69	66	64	61	58				
	400	189	0.04	10	65	52	49	48	46	42	68	58	54	53	52	47	71	60	57	54	52	50	75	65	61	58	56	55				
9	1050	496	0.17	42	72	62	61	58	57	52	76	67	65	62	61	57	79	69	68	65	63	62	84	75	72	68	65	65				
	850	401	0.11	27	69	59	59	56	53	50	71	64	63	60	58	54	76	67	65	62	61	59	82	71	69	66	65	62				
	650	307	0.07	17	66	56	55	53	50	46	71	61	59	56	55	51	74	64	62	59	58	55	79	69	66	62	62	60				
	450	212	0.03	7	62	52	51	48	46	41	66	56	55	52	51	44	70	59	58	54	53	50	74	64	62	59	58	57				
10	1350	637	0.16	40	72	62	60	57	57	53	77	67	64	61	61	57	80	71	67	64	64	62	85	76	72	69	68	65				
	1150	543	0.12	30	70	60	58	56	55	51	75	65	62	60	59	55	78	69	66	62	62	61	81	73	69	66	66	63				
	950	448	0.09	22	68	57	56	53	52	49	73	63	60	58	57	54	76	66	64	60	59	60	81	71	67	64	64	62				
	750	354	0.05	12	65	54	53	50	50	47	70	59	57	54	54	51	72	63	60	51	56	54	78	68	64	62	60	61				
12	2100	991	0.19	47	73	65	63	61	60	55	79	70	67	66	64	59	82	73	70	67	67	64	87	76	74	72	72	69				
	1700	802	0.12	30	71	62	60	58	57	53	76	67	65	62	61	58	79	70	67	64	64	62	84	75	72	69	68	67				
	1300	614	0.07	17	67	58	57	54	53	50	73	64	61	58	58	55	76	67	64	61	60	60	81	71	68	65	64	64				
	900	425	0.03	7	63	54	52	50	49	47	68	59	57	53	52	52	71	62	59	56	55	57	77	67	63	60	59	60				
14	3200	1510	0.25	62	75	68	66	64	63	65	81	73	71	67	66	69	84	76	73	70	69	71	89	81	77	74	73	73				
	2700	1274	0.19	47	73	65	64	61	61	63	78	70	68	65	65	67	81	73	71	68	67	69	86	78	75	71	71	72				
	2200	1038	0.12	30	70	62	61	58	58	59	75	67	66	63	63	64	78	70	68	65	64	67	83	75	72	70	68	69				
	1700	802	0.06	15	67	58	58	55	55	53	72	63	62	59	59	57	75	66	65	61	61	59	80	71	69	66	64	62				
16	4000	1888	0.21	52	74	66	66	63	62	61	79	72	71	67	67	66	82	75	73	70	70	72	88	80	78	74	73	75				
	3500	1652	0.15	37	73	65	64	62	61	60	78	70	69	66	65	62	81	74	72	68	67	68	86	79	76	72	71	72				
	3000	1416	0.11	27	71	62	63	60	59	58	76	67	67	63	63	59	78	71	70	66	66	67	83	76	74	70	68	70				
	2000	944	0.04	10	66	56	57	54	53	53	70	61	61	58	58	59	73	65	64	61	60	65	78	71	68	65	65	68				

Performance Notes:

- Discharge sound power is the noise emitted from the unit discharge into the downstream duct.
- Sound power levels are in decibels, dB re 10⁻¹² watts.
- All sound data listed by octave bands is raw data without any corrections for room absorption or duct attenuation.
- Min. inlet ΔPs is the minimum operating pressure requirement (damper full open).
- Data derived from tests conducted in accordance with ANSI/ASHRAE Standard 130 and AHRI Standard 880.

Performance Data • Radiated Sound Power Levels

Model 36VRR

Unit Size	Airflow		Min. inlet ΔPs		Sound Power Octave Bands Center @ Inlet Pressure ΔPs shown																							
					0.5" w.g. (125 Pa) ΔPs					1.0" w.g. (375 Pa) ΔPs					1.5" w.g. (375 Pa) ΔPs					3.0" w.g. (750 Pa) ΔPs								
					2	3	4	5	6	7	2	3	4	5	6	7	2	3	4	5	6	7	2	3	4	5	6	7
4	225	106	0.25	62	50	42	42	44	47	40	53	44	45	49	51	44	55	48	48	50	54	49	60	54	55	55	58	52
	200	94	0.20	50	49	37	38	40	44	38	48	40	42	45	47	40	50	43	45	46	49	41	53	45	47	49	52	45
	150	71	0.10	25	24	26	27	33	35	27	40	31	35	38	39	33	46	35	37	40	45	38	49	43	43	45	48	40
	100	47	0.05	12	-	-	-	24	28	-	-	-	26	29	34	26	-	21	26	30	37	31	42	33	34	36	40	34
5	350	165	0.32	80	54	45	45	46	47	41	55	51	52	52	54	46	60	52	52	53	55	50	65	57	58	58	60	55
	300	142	0.23	57	49	41	41	42	46	37	50	47	47	48	50	43	58	49	49	51	52	46	60	53	55	57	59	52
	200	94	0.11	27	43	26	35	38	40	27	42	38	39	41	44	33	48	40	41	43	45	36	53	45	46	46	48	42
	100	47	0.03	7	-	-	21	23	25	-	-	-	21	29	32	-	-	-	22	33	36	21	41	31	35	36	40	26
6	450	212	0.22	55	53	45	44	48	49	42	57	50	49	52	53	48	59	51	51	55	55	51	63	57	57	59	59	56
	400	189	0.18	45	51	42	42	46	41	39	55	47	47	50	51	45	57	50	50	52	53	48	61	52	54	57	58	53
	300	142	0.10	25	46	37	37	40	41	32	50	42	42	44	46	37	52	44	44	47	48	41	56	49	48	51	52	46
	200	94	0.04	10	30	25	28	32	34	22	43	23	34	37	39	27	45	36	37	39	41	30	49	41	41	44	45	36
7	650	307	0.21	52	53	44	44	42	48	45	59	52	52	53	54	51	61	52	53	52	54	54	64	58	58	57	59	64
	550	260	0.14	35	49	42	42	43	46	41	56	49	48	49	52	47	58	50	50	51	52	50	59	54	53	54	56	60
	450	212	0.10	25	45	38	37	39	43	36	51	43	43	44	46	42	52	44	45	45	47	45	55	50	51	52	54	53
	350	165	0.06	15	40	34	34	32	36	30	44	35	36	38	41	35	50	41	42	43	44	39	52	44	45	45	47	49
8	800	378	0.17	42	54	45	45	44	47	44	58	51	52	50	52	50	62	53	52	53	54	54	65	58	58	57	60	59
	700	330	0.13	32	52	43	43	41	45	41	57	50	50	51	51	46	59	50	50	49	53	51	60	54	53	54	57	56
	600	283	0.10	25	48	39	38	37	43	37	53	44	44	46	49	42	55	46	47	48	49	47	58	51	52	52	55	52
	400	189	0.04	10	44	32	30	29	35	27	43	34	35	35	40	32	49	40	42	43	44	37	51	43	44	43	46	42
9	1050	496	0.17	42	56	47	45	45	48	47	60	52	51	51	52	53	63	55	54	54	55	56	67	61	60	59	62	62
	850	401	0.11	27	53	43	43	43	44	42	56	47	47	46	49	47	59	51	50	48	53	51	63	56	57	56	58	56
	650	307	0.07	17	46	36	35	34	42	35	51	42	41	41	43	41	54	45	44	45	47	44	59	53	52	52	54	50
	450	212	0.03	7	42	29	27	26	30	26	47	34	33	32	37	32	49	35	36	35	45	35	51	46	47	45	49	41
10	1350	637	0.16	40	58	49	47	47	49	48	62	54	53	52	53	53	64	57	56	56	57	60	69	63	61	61	63	62
	1150	543	0.12	30	56	46	45	44	46	45	59	51	50	49	52	50	61	54	53	53	55	53	65	59	58	58	60	58
	950	448	0.09	22	52	42	41	41	43	41	56	48	46	46	48	45	58	51	49	49	51	48	62	55	55	54	56	55
	750	354	0.05	12	48	38	37	36	38	35	53	43	42	41	44	40	54	47	45	44	47	44	58	52	50	49	52	49
12	2100	991	0.19	47	63	55	54	53	53	52	66	59	58	57	58	58	68	62	61	59	62	61	72	66	65	64	65	66
	1700	802	0.12	30	57	51	49	48	49	48	61	55	54	51	54	53	64	57	56	55	57	57	68	61	60	59	61	61
	1300	614	0.07	17	52	45	44	43	44	41	56	48	48	47	48	47	58	51	51	50	52	50	62	54	55	51	56	55
	900	425	0.03	7	45	37	36	36	37	32	48	40	40	39	42	38	51	42	42	42	44	41	55	46	47	46	49	47
14	3200	1510	0.25	62	66	57	55	53	55	59	70	62	58	57	59	63	72	67	63	61	62	65	75	68	67	65	66	70
	2700	1274	0.19	47	63	54	52	50	52	51	66	58	56	54	56	57	68	61	58	56	58	61	72	65	63	61	63	67
	2200	1038	0.12	30	58	50	47	46	47	46	62	53	52	50	52	52	64	56	54	53	55	56	67	60	59	58	60	62
	1700	802	0.06	15	53	44	42	41	43	41	56	48	47	45	47	46	58	50	49	48	46	50	62	55	53	52	55	55
16	4000	1888	0.21	52	67	58	56	53	56	57	71	62	60	59	61	62	73	64	64	61	63	66	76	70	69	66	68	71
	3500	1652	0.15	37	65	55	52	51	54	54	68	60	58	56	58	59	70	62	60	58	59	61	73	67	66	64	65	67
	3000	1416	0.11	27	61	51	49	47	50	50	65	56	55	53	54	55	67	58	57	55	58	58	70	63	62	60	62	63
	2000	944	0.04	10	52	42	40	39	42	40	56	47	45	44	47	45	58	49	49	46	49	48	62	53	53	52	54	53

Performance Notes:

- Radiated sound power is the breakout noise transmitted through the unit casing walls.
- Sound power levels are in decibels, dB re 10⁻¹² watts.
- All sound data listed by octave bands is raw data without any corrections for room absorption or duct attenuation.
- Min. inlet ΔPs is the minimum operating pressure requirement (damper full open).
- Data derived from tests conducted in accordance with ANSI/ASHRAE Standard 130 and AHRI Standard 880.

SLIDE-IN RETROFIT TERMINAL UNITS MODEL 36VRS

- SQUARE OR RECTANGULAR
- VARIABLE AIR VOLUME CONVERSION

A slide-in type Retrofit Air Terminal Unit for square or rectangular ductwork. Converts constant volume systems to variable air volume. Available in 15 individual valve sizes up to 15,000 cfm (7079 l/s). Nominal valve size is the same as smallest available duct size in table. Each unit (valve) size is available to suit various duct sizes as shown in the table. Top, bottom and/or side blank-off plates are used to bring valve up to the required nominal ductwork dimension. Airflow ranges are based on valve size and acoustical considerations for duct velocity. Model 36VRS is available to suit duct sizes within the tabulated range in 1" (25) increments.

Simple, low cost installation into existing ductwork. The installer cuts a rectangular hole in the side of the duct, cuts away the insulation (where present), slides the unit into the duct and screws the mounting plate to the side of the duct.

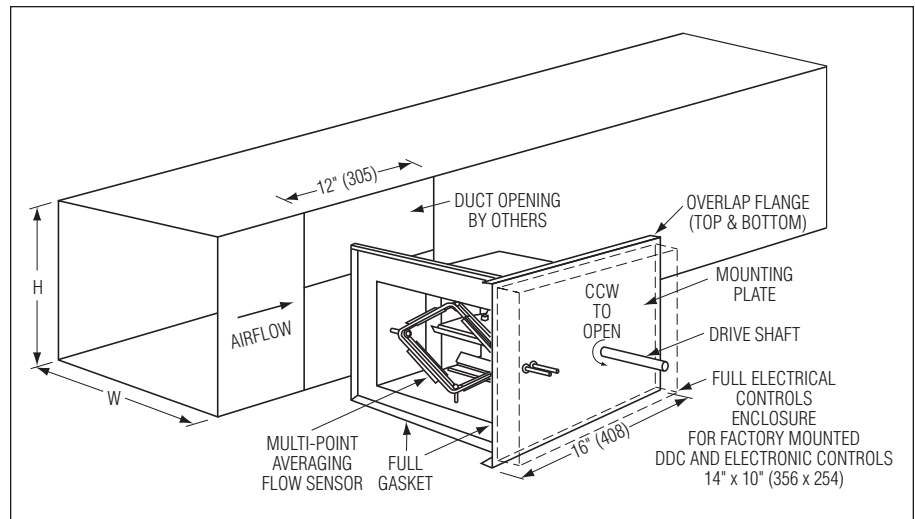

STANDARD FEATURES:

- Damper: 16 ga. (1.6) galvanized steel blade and frame construction with extruded PVC blade seals and metallic side jamb seals. Leakage is less than 2% of nominal CFM @ 3.0" w.g. (746 Pa) as tested in accordance with ASHRAE Standard 130.
- Bearings: Celcon[®].
- Drive Shaft: 1/2" (13) dia. plated steel, double-bolted to blade. Indicator mark on the end of the shaft to show damper position. 90° rotation. CW to close.
- Full electrical controls enclosure for factory mounted DDC and analog electronic controls.
- Multi-point averaging 'Diamond Flow' sensor: Aluminum. Gauge taps are provided for field balancing when controls are factory mounted.

- Gasket under the mounting plate and around periphery of terminal insert seal the unit to the sides of the duct.

Options:

- Controls enclosure for field mounted controls.
- 24 volt control transformer.
- Toggle disconnect switch.
- Pneumatic or Analog Electronic Pressure Independent controls by Nailor. Factory mounted and calibrated.
- Digital controls by BMS Contractor. Factory mounted by Nailor.

Dimensional Data:

Unit (valve) Size	Available Duct Size Width x Height	
	inches	mm
7	5 x 5 to 12 x 8	127 x 127 to 305 x 203
8	6 x 6 to 12 x 10	152 x 152 to 305 x 254
9	8 x 6 to 16 x 10	203 x 152 to 406 x 254
10	10 x 8 to 18 x 12	254 x 203 to 457 x 305
11	14 x 8 to 22 x 12	356 x 203 to 559 x 305
11A	18 x 6 to 26 x 10	457 x 152 to 660 x 254
12	12 x 10 to 22 x 14	305 x 254 to 559 x 356
13	18 x 10 to 28 x 14	457 x 254 to 711 x 356
14	18 x 12 to 28 x 16	457 x 305 to 711 x 406
15	20 x 14 to 30 x 18	508 x 356 to 762 x 457
15A	30 x 12 to 36 x 16	762 x 305 to 914 x 406
16	22 x 16 to 36 x 20	559 x 406 to 914 x 508
17	24 x 18 to 36 x 26	610 x 457 to 914 x 660
18	30 x 20 to 46 x 26	762 x 508 to 1168 x 660
19	40 x 20 to 52 x 26	1016 x 508 to 1321 x 660

Recommended Airflow Ranges For Model 36VRS Slide-in Retrofit Terminal Units

The recommended airflow ranges below are for terminal units with pressure independent controls and are based upon controller sensitivity limits as shown for each control type and acoustical consideration for duct velocity. For a given unit size, the minimum, auxiliary minimum (where applicable) and the maximum flow settings must be within the range limits to ensure pressure independent operation, accuracy and repeatability. For these reasons, factory settings will not be made outside these ranges. A minimum setting of zero (shut-off) is also available. Where an auxiliary setting is specified, the value must be greater than the minimum setting.

When digital or other controls are mounted by Nailor, but supplied by others, these values are guidelines only, based upon experience with the majority of controls currently available. Controls supplied by others for factory mounting are configured and calibrated in the field.



Model 36VRS

Model 36VRS Square or Rectangular

Unit Size	Nom. Valve Size	Min. – Max. Airflow Range				Available Duct Size Width x Height	
		Pneumatic		Digital/Analog			
		cfm	l/s	cfm	l/s	inches	mm
7	5 x 5	70 – 200	33 – 94	60 – 200	28 – 94	5 x 5 to 12 x 8	127 x 127 to 305 x 203
8	6 x 6	110 – 300	52 – 142	85 – 300	40 – 142	6 x 6 to 14 x 10	152 x 152 to 356 x 254
9	8 x 6	140 – 400	66 – 189	110 – 400	52 – 189	8 x 6 to 16 x 10	203 x 152 to 406 x 254
10	10 x 8	240 – 700	113 – 330	180 – 700	85 – 330	10 x 8 to 18 x 12	254 x 203 to 457 x 305
11	14 x 8	320 – 1000	151 – 472	260 – 1000	123 – 472	14 x 8 to 24 x 12	356 x 203 to 610 x 305
11A	18 x 6	310 – 1000	146 – 472	250 – 1000	118 – 472	18 x 6 to 26 x 10	457 x 152 to 660 x 254
12	12 x 10	350 – 1100	165 – 519	280 – 1100	132 – 519	12 x 10 to 22 x 14	305 x 254 to 559 x 356
13	18 x 10	500 – 1900	236 – 897	435 – 1900	205 – 897	18 x 10 to 30 x 14	457 x 254 to 762 x 356
14	18 x 12	650 – 2400	307 – 1133	540 – 2400	255 – 1133	18 x 12 to 28 x 16	457 x 305 to 711 x 406
15	20 x 14	850 – 3800	401 – 1794	700 – 3800	330 – 1794	20 x 14 to 30 x 18	508 x 356 to 762 x 457
15A	30 x 12	1020 – 5400	481 – 2549	870 – 5400	411 – 2549	30 x 12 to 36 x 16	762 x 305 to 914 x 406
16	22 x 16	1000 – 5400	472 – 2549	850 – 5400	401 – 2549	22 x 16 to 36 x 20	559 x 406 to 914 x 508
17	24 x 18	1250 – 6700	590 – 3162	1100 – 6700	519 – 3162	24 x 18 to 36 x 26	610 x 457 to 914 x 660
18	30 x 20	1750 – 10000	826 – 4720	1500 – 10000	708 – 4720	30 x 20 to 46 x 26	762 x 508 to 1168 x 660
19	40 x 20	2300 – 15000	1085 – 7080	1900 – 15000	897 – 7080	40 x 20 to 52 x 26	1016 x 508 to 1321 x 660

Performance Data • NC Level Application Guide

Model 36VRS

Inlet Size	Valve Size	Duct W x H	Airflow		Min. inlet ΔPs		NC Levels @ Inlet Pressure (ΔPs) shown							
							DISCHARGE				RADIATED			
							0.5" w.g. (125 Pa)	1.0" w.g. (250 Pa)	2.0" w.g. (500 Pa)	3.0" w.g. (750 Pa)	0.5" w.g. (125 Pa)	1.0" w.g. (250 Pa)	2.0" w.g. (500 Pa)	3.0" w.g. (750 Pa)
cfm	l/s	"w.g.	Pa											
7	5 x 5	5 x 5	70	33	0.004	1	-	23	31	36	22	30	36	40
			140	66	0.016	4	-	24	33	38	23	31	37	41
			200	94	0.033	8	-	25	34	39	24	32	38	42
		8 x 8	70	33	0.024	6	-	-	22	27	-	21	28	32
			140	66	0.094	23	-	-	24	29	-	23	29	33
			200	94	0.191	47	-	-	25	30	-	24	30	34
		12 x 8	70	33	0.043	11	-	-	-	22	-	-	23	27
			140	66	0.172	43	-	-	-	24	-	-	25	28
			200	94	0.350	87	-	-	20	25	-	20	26	29
8	6 x 6	6 x 6	110	52	0.004	1	-	24	33	38	25	31	38	42
			200	94	0.013	3	-	24	32	37	24	31	37	41
			300	142	0.030	7	-	25	34	39	25	32	38	42
		10 x 8	110	52	0.019	5	-	-	25	30	-	25	31	35
			200	94	0.064	16	-	-	25	30	-	24	30	34
			300	142	0.145	36	-	-	26	31	-	25	31	35
		14 x 10	110	52	0.039	10	-	-	20	25	-	20	26	30
			200	94	0.128	32	-	-	20	24	-	-	25	29
			300	142	0.288	72	-	-	20	26	-	20	26	30
9	8 x 6	8 x 6	140	66	0.004	1	-	23	31	36	23	30	36	40
			270	127	0.014	3	-	23	32	37	24	30	36	40
			400	189	0.031	8	-	24	32	37	24	31	37	41
		12 x 8	140	66	0.019	5	-	-	24	29	-	23	29	33
			270	127	0.070	17	-	-	25	30	-	24	30	34
			400	189	0.153	38	-	-	26	31	-	25	31	35
		16 x 10	140	66	0.031	8	-	-	20	25	-	-	26	29
			270	127	0.114	28	-	-	20	25	-	20	26	30
			400	189	0.251	62	-	-	21	26	-	20	27	30
10	10 x 8	10 x 8	240	113	0.007	2	-	23	32	37	24	30	36	40
			480	227	0.027	7	-	25	33	38	25	32	38	42
			700	330	0.057	14	-	26	34	39	26	32	39	43
		14 x 10	240	113	0.023	6	-	-	26	31	-	25	32	35
			480	227	0.091	23	-	-	28	33	20	27	33	37
			700	330	0.193	48	-	20	29	34	21	28	34	38
		18 x 12	240	113	0.050	12	-	-	21	26	-	20	26	30
			480	227	0.200	50	-	-	23	28	-	23	29	33
			700	330	0.426	106	-	-	24	29	-	24	30	34
11	14 x 8	14 x 8	320	151	0.006	1	-	-	28	33	20	26	33	36
			650	307	0.024	6	-	24	33	38	24	31	37	41
			1000	472	0.057	14	-	25	34	39	25	32	38	42
		18 x 10	320	151	0.017	4	-	-	23	28	-	22	29	32
			650	307	0.072	18	-	-	25	33	20	27	33	37
			1000	472	0.170	42	-	20	29	34	21	28	34	38
		24 x 14	320	151	0.042	10	-	-	-	33	-	-	23	27
			650	307	0.172	43	-	-	22	27	-	21	28	31
			1000	472	0.406	101	-	-	23	28	-	22	29	32
11A	18 x 6	18 x 6	310	146	0.007	2	-	-	28	33	20	26	33	36
			650	307	0.030	7	-	23	32	37	24	30	36	40
			1000	472	0.070	17	17	26	34	39	26	32	39	43
		22 x 8	310	146	0.025	6	-	-	22	27	-	21	27	31
			650	307	0.109	27	-	-	26	31	-	25	31	35
			1000	472	0.258	64	-	20	29	34	21	27	34	37
		26 x 10	310	146	0.037	9	-	-	20	25	-	-	25	29
			650	307	0.161	40	-	-	23	28	-	22	29	33
			1000	472	0.380	94	-	-	26	31	-	25	31	35
12	12 x 10	12 x 10	350	165	0.006	1	-	20	28	33	20	27	33	37
			725	342	0.025	6	-	24	33	38	25	31	37	41
			1100	519	0.057	14	-	26	34	39	26	32	39	43
		18 x 12	350	165	0.026	6	-	-	22	27	-	21	28	31
			725	342	0.110	27	-	-	26	31	-	25	31	35
			1100	519	0.253	63	-	-	27	32	20	26	32	36
		24 x 14	350	165	0.044	11	-	-	-	23	-	-	24	28
			725	342	0.188	47	-	-	23	28	-	22	28	32
			1100	519	0.433	108	-	-	24	29	-	23	30	34
13	18 x 10	18 x 10	500	236	0.006	1	-	21	30	35	22	28	35	38
			1200	566	0.034	8	-	25	34	39	26	32	38	42
			1900	897	0.084	21	-	25	34	39	25	32	38	42
		24 x 12	500	236	0.017	4	-	-	25	31	-	24	31	34
			1200	566	0.098	24	-	21	29	34	21	28	34	38
			1900	897	0.246	61	-	21	29	34	21	28	34	38
		30 x 14	500	236	0.030	7	-	-	22	27	-	21	27	31
			1200	566	0.173	43	-	-	26	31	-	25	31	35
			1900	897	0.434	108	-	-	26	31	-	25	31	35

RETROFIT TERMINAL UNITS

D

Performance Data • NC Level Application Guide

Model 36VRS

Inlet Size	Valve Size	Duct W x H	Airflow		Min. inlet Δ Ps		NC Levels @ Inlet Pressure (Δ Ps) shown							
							DISCHARGE				RADIATED			
							0.5" w.g. (125 Pa)	1.0" w.g. (250 Pa)	2.0" w.g. (500 Pa)	3.0" w.g. (750 Pa)	0.5" w.g. (125 Pa)	1.0" w.g. (250 Pa)	2.0" w.g. (500 Pa)	3.0" w.g. (750 Pa)
cfm	l/s	"w.g.	Pa											
14	18 x 12	18 x 12	650	307	0.003	1	-	21	29	34	21	28	34	38
			1525	720	0.019	5	-	22	31	36	23	29	36	39
			2400	1133	0.048	12	-	24	33	38	25	31	37	41
		24 x 14	650	307	0.010	2	-	-	25	30	-	24	30	34
			1525	720	0.054	13	-	-	27	32	-	25	32	36
			2400	1133	0.134	33	-	20	29	34	21	27	34	37
		28 x 16	650	307	0.015	4	-	-	22	27	-	21	28	31
			1525	720	0.085	21	-	-	24	29	-	23	29	33
			2400	1133	0.210	52	-	-	26	31	-	25	31	35
15	20 x 14	20 x 14	850	401	0.004	1	-	20	29	34	21	27	33	37
			2325	1097	0.027	7	-	24	32	37	24	30	37	41
			3800	1793	0.073	18	-	25	34	39	26	32	39	42
		26 x 16	850	401	0.009	2	-	-	25	30	-	24	30	34
			2325	1097	0.071	18	-	20	29	34	21	27	33	37
			3800	1793	0.190	47	-	22	30	35	22	29	35	39
		30 x 18	850	401	0.041	10	-	-	23	28	-	21	28	32
			2325	1097	0.109	27	-	-	26	31	-	25	31	35
			3800	1793	0.290	72	-	-	28	33	20	26	33	37
15A	30 x 12	30 x 12	1020	481	0.003	1	-	21	29	34	21	27	34	37
			3200	1510	0.034	8	-	24	33	38	24	31	37	41
			5400	2548	0.098	24	-	26	34	39	26	32	39	43
		34 x 14	1020	481	0.007	2	-	-	27	32	-	25	31	35
			3200	1510	0.072	18	-	21	30	35	22	28	35	38
			5400	2548	0.204	51	-	23	32	37	24	30	36	40
		36 x 16	1020	481	0.010	2	-	-	25	30	-	23	30	33
			3200	1510	0.102	25	-	20	28	33	20	27	33	37
			5400	2548	0.290	72	-	21	30	35	22	28	35	38
16	22 x 16	22 x 16	1000	472	0.003	1	-	21	29	38	21	27	34	37
			3200	1510	0.026	6	-	24	33	38	24	31	37	41
			5400	2548	0.074	18	-	28	36	41	28	34	41	44
		28 x 18	1000	472	0.006	1	-	-	26	35	-	24	31	34
			3200	1510	0.063	16	-	20	29	34	21	28	34	38
			5400	2548	0.179	44	-	24	33	38	25	31	38	41
		36 x 20	1000	472	0.011	3	-	-	22	31	-	21	28	31
			3200	1510	0.112	28	-	-	26	31	-	24	31	35
			5400	2548	0.320	80	-	21	29	35	22	28	35	38
17	24 x 18	24 x 18	1250	590	0.003	1	-	21	29	34	21	27	34	37
			4000	1888	0.033	8	-	25	34	39	25	32	38	42
			6700	3162	0.092	23	-	28	36	41	28	34	41	44
		30 x 24	1250	590	0.010	2	-	-	24	29	-	23	29	33
			4000	1888	0.103	26	-	20	29	34	21	27	34	37
			6700	3162	0.290	72	-	23	31	36	23	30	36	40
		36 x 26	1250	590	0.015	4	-	-	22	27	-	21	27	31
			4000	1888	0.153	38	-	-	26	31	-	25	31	35
			6700	3162	0.430	107	-	20	29	34	21	28	34	38
18	30 x 20	30 x 20	1750	826	0.003	1	-	20	29	34	21	27	33	37
			5875	2773	0.030	7	-	28	36	41	28	34	41	45
			10000	4719	0.086	21	-	28	36	41	28	34	41	44
		38 x 24	1750	826	0.007	2	-	-	25	30	-	23	30	33
			5875	2773	0.080	20	-	24	32	37	24	31	37	41
			10000	4719	0.233	58	-	24	32	37	24	31	37	41
		46 x 26	1750	826	0.011	3	-	-	22	27	-	21	27	31
			5875	2773	0.124	31	-	21	30	35	22	28	35	39
			10000	4719	0.360	89	-	21	30	35	22	28	35	39
19	40 x 20	40 x 20	2300	1085	0.003	1	-	20	28	33	20	26	33	37
			8650	4082	0.038	9	-	26	35	40	26	33	39	43
			15000	7079	0.115	29	20	29	38	43	29	36	42	46
		46 x 24	2300	1085	0.006	1	-	-	25	35	-	24	30	34
			8650	4082	0.086	21	-	26	35	36	26	33	39	43
			15000	7079	0.258	64	-	26	34	37	26	33	39	43
		52 x 26	2300	1085	0.009	2	-	-	23	33	-	22	28	32
			8650	4082	0.123	31	-	26	35	34	26	33	39	43
			15000	7079	0.370	92	-	24	33	35	25	31	37	41

For full performance table notes, see page D7.

ROUND DUCT FLOW MEASURING STATIONS

MODEL 36FMI, INSERT TYPE
 MODEL 36FMS, SLEEVE TYPE
 MODEL 36FMSD, WITH BALANCING DAMPER

- MULTI-POINT AVERAGING FLOW SENSOR

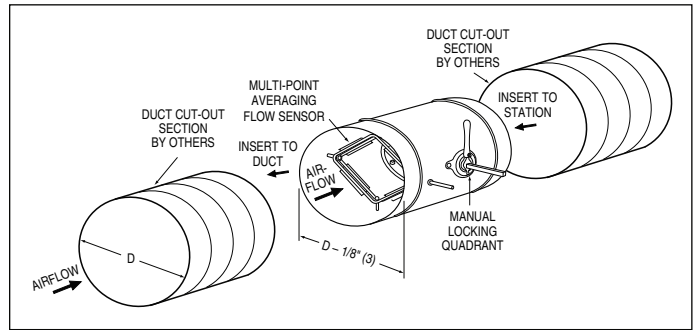

The Model 36FMSD Flow Measuring Station is a multi-point averaging airflow sensor combined with integral balancing damper. The 36FMSD allows the field balancer to measure and adjust the airflow to a diffuser or other air terminal device located downstream.

The 36FMSD is an especially useful option for balancing individual displacement ventilation diffusers.

A chart is provided on the unit which gives airflow vs. signal differential pressure for direct reading of airflow.

STANDARD FEATURES:

- 22 ga. (0.86) corrosion-resistant steel casing with stiffening beads and corrosion-resistant steel blade up to 12" (305) dia., 20 ga. (1.00) over 12" (305) dia.
- Sized to fit nominal round duct sizes.
- Inlet and outlet stiffening beads provide a means for secure flexible duct connection.
- Balancing damper with hand locking quadrant.
- Multi-point averaging Diamond Flow Sensor: Aluminum construction.
- Sensor design minimizes pressure drop and regenerated noise.

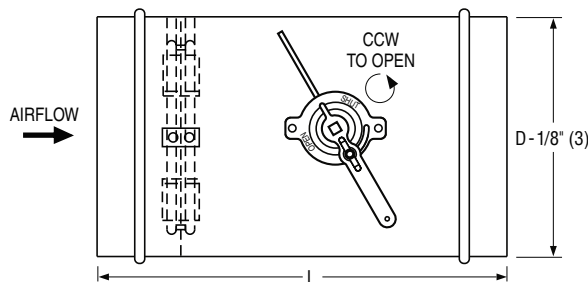
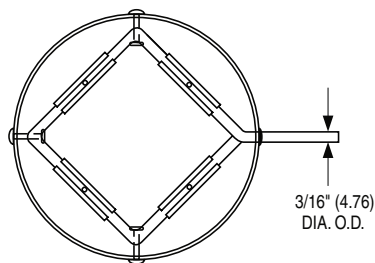
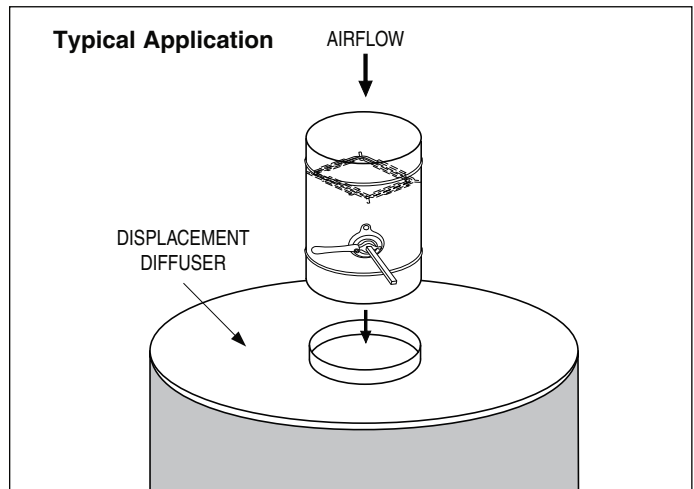

Dimensional Data – 36MSFD

Unit Size	Airflow Range cfm (l/s)	Duct Size D	Length L
4	0 – 225 (0 – 106)	4 (102)	13 (330)
5	0 – 400 (0 – 189)	5 (127)	13 (330)
6	0 – 550 (0 – 260)	6 (152)	13 (330)
7	0 – 800 (0 – 378)	7 (178)	13 (330)
8	0 – 1100 (0 – 519)	8 (203)	13 (330)
9	0 – 1400 (0 – 661)	9 (229)	13 (330)
10	0 – 1840 (0 – 868)	10 (254)	13 (330)
12	0 – 2500 (0 – 1180)	12 (305)	13 (330)
14	0 – 3125 (0 – 1475)	14 (356)	15 (381)
16	0 – 3725 (0 – 1758)	16 (406)	15 (381)
18	0 – 5880 (0 – 2775)	18 (457)	16 (406)



BYPASS TERMINAL UNITS



TABLE OF CONTENTS

	Page No.
Introduction and Features	E3
Model 3400 • Cooling	
Model 34RW • Cooling • Hot Water Reheat	
Model 34RE • Cooling • Electric Reheat	
Flow Diverter Valve and Electronic Modulating Controls	E4
Dimensional Data	
Model 3400 • Basic Unit with Controls	E5
• Integral Sound Attenuator	E6
Model 34RW • Hot Water Reheat	E7
• Integral Attenuator plus Hot Water Reheat	E8
Model 34RE • Integral Electric Reheat	E8
Options • Access Door	E9
• FF Round Discharge Collar	
Accessories • MOA Multi-Outlet Attenuator	E10
Performance Data	
3400 Series • NC Level Application Guide	E11
• Sound Power Levels	E12
• AHRI Certification and Performance Data	E13
Performance Data Explanation	E14
Performance Data • Hot Water Coil	E15
Electric Heating Coils Selection, Capacities and Features	E20
Balancing Procedure	E21

BYPASS TERMINAL UNITS 3400 SERIES

- "DUMP BOX"
- UNIQUE "FLOW DIVERTER" VALVE

Models:

- 3400** **Cooling**
- 34RW** **Cooling with
Hot Water Reheat**
- 34RE** **Cooling with
Electric Reheat**

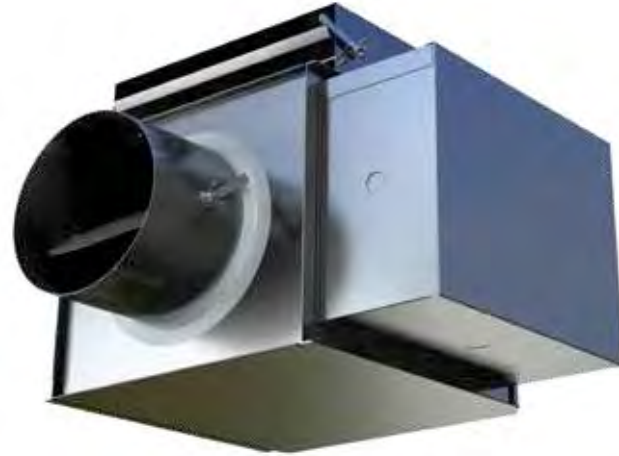

Model 3400

The **3400 Series – Bypass Terminal Unit** is a single duct pressure dependent air terminal unit, designed for use with popular constant volume low and medium pressure packaged air handling systems or roof top air conditioning units at low prime cost. Units may be used with cooling and heating/cooling systems. Temperature control is achieved by supplying only enough conditioned air to the space to satisfy room thermostat demand. Excess air is diverted (bypassed) directly to the return air ceiling plenum for free or ducted return. Airflow to each occupied zone will vary on thermostat demand, from full flow to shut-off or to a mechanically set minimum air volume.

A bypass box, commonly referred to also as a "dump box" handles a constant supply of primary air through its inlet and uses a diverting damper to bypass part of the supply air into the plenum return. The damper is directly controlled by the room thermostat in the occupied space to provide the volume of air required to meet the thermal demand. The pressure requirement through the supply air path to the conditioned space is set with an inlet balancing damper. A second manual balancing damper in the bypass is field adjusted to match the resistance in the discharge duct in order to maintain minimum airflow to the space, maintain supply air from the primary system at a constant volume and ensure smooth modulation of the supply airflow volume.

Bypass terminals can be added to a single-zone constant volume system to provide zoning without the energy penalty of a conventional reheat system, providing low first cost with minimum fan controls. Although variable volume to the space in operation, total airflow of the fan remains constant, so the fan power and associated energy cost are not reduced. This method is therefore energy inefficient as compared to a VAV fan system. Its most frequent application is on small systems.

FEATURES:

- Casing – 22 ga. galvanized steel with round or flat oval inlets. Outlets are rectangular with slip and drive connections.
- Damper – Heavy gauge steel cylindrical Flow Diverter valve design for reliable long term operation. Eliminates any internal damper linkage. 90° rotation. CW to close.
- 1/2" (13) dia. plated steel drive shaft. An indicator mark on the end of the shaft shows damper position.
- 3/4" (19) dual density insulation. Exposed edges are coated to prevent airflow erosion. Material meets requirement of NFPA 90A and UL 181 standards.
- Inlet balancing damper.
- Easily adjustable bypass port balancing dampers.

- Sizes range from 6" (152) to 16" (406) with capacities from 100 to 2750 cfm. Tested in accordance with ANSI / ASHRAE Standard 130 and AHRI Standard 880, in an independent test laboratory.

- Compact low profile design is ideally suited for installation in tight spaces.

- Minimum air volume stop on electric actuator. It cannot be factory set and must be field adjusted as required for the application.

Controls:

- Pressure dependent pneumatic or analog electronic control. Factory supplied and mounted.
- Variety of control options available, based on applications.
- Electronic thermostat and actuator provide accurate modulating control.

Options:

- Hot water and electric reheat coil sections.
- Multi-outlet plenum.
- Round/Oval discharge collar.



Intertek



Unique "Flow Diverter" Valve

Nailor's 3400 Series Mark II bypass terminal units utilize a unique cylindrical flow diverter valve for superior control and performance. A common problem with standard pivoted single blade damper designs is objectionable noise and loss of modulation due to pulsating and/or a snap-closing action of the valve. This is caused by a poor valve design, which struggles to modulate turbulent airflow and requires excessive torque.

The Nailor flow diverter valve eliminates these problems. The rugged cylindrical damper design smoothly modulates between supply and bypass conditions and when installed under airflow is essentially self-balancing, requiring only a negligible torque requirement. The result is superior reliable long-term performance and quiet operation.

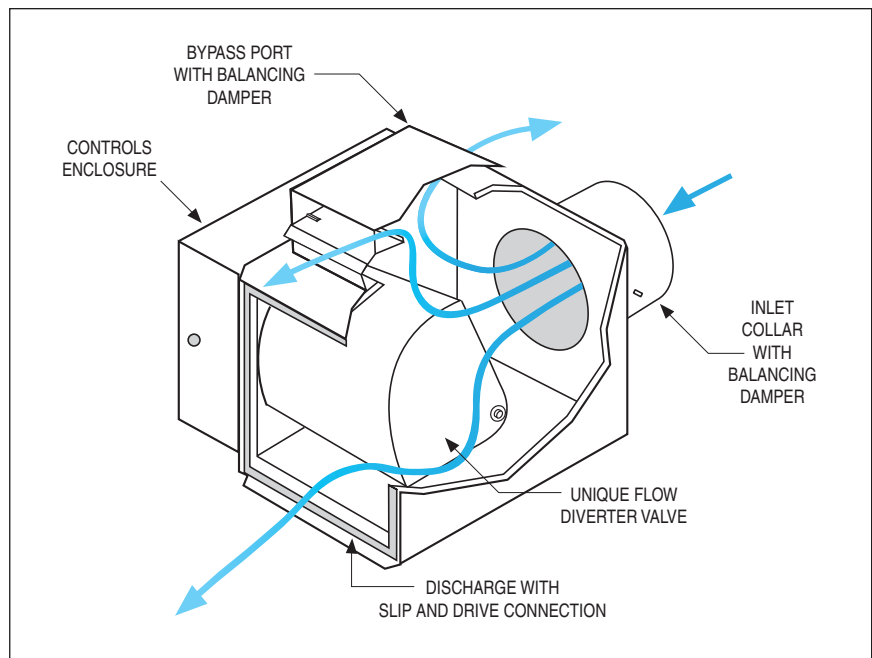

Analog Electronic Modulating Controls

Nailor offers a series of analog electronic control packages which provide true modulating control and superior performance over conventional electric controls. These older packages essentially provide on/off control of the bypass terminal. Commonly, the damper is driven to the full supply or full bypass position before a change in space temperature is sensed by the room thermostat. Low speed actuators are often used to slow the damper response, but result in sluggish control and large swings in occupied space temperature which waste energy and provide poor comfort.



Digital display room thermostat (VT7200C5000), Floating actuator (MEP-4003) and Auto changeover duct temperature sensor.

Nailor's analog electronic packages feature advanced microcomputer electronics and proportional plus integral (P + I) control algorithms to provide precise temperature control. The digital display thermostat provides a true multi-position modulating output to a conventional 24 VAC tri-state floating actuator. The thermostat output cycles the actuator with shorter or longer "on times" proportional to the temperature offset, preventing temperature overshoot. The thermostat also tracks how long the room temperature has varied from set point and adjusts the output accordingly. This eliminates wasted energy caused by typical on/off cycling with conventional SPDT thermostats, resulting in significant energy savings and superior comfort. Control deadband accuracy is +/- 0.4°F (+/- 0.2°C) around set point. When an electric reheat stage is required, depending on the control sequence selected, the electronic thermostat can provide a time proportional output signal (10 second time base) to a SSR/SCR that proportionately modulates the reheat coil, adjusting the amount of "on time" in accordance with room temperature offset.

Options:

- 24 VAC Control transformer.
- Toggle disconnect switch.

BYPASS TERMINAL UNITS

Dimensions

Model 3400 • Basic Unit with Controls

Digital and Analog Electronic Controls

- A full NEMA1 controls enclosure is provided for factory mounted controls. Optional for field mounted controls.

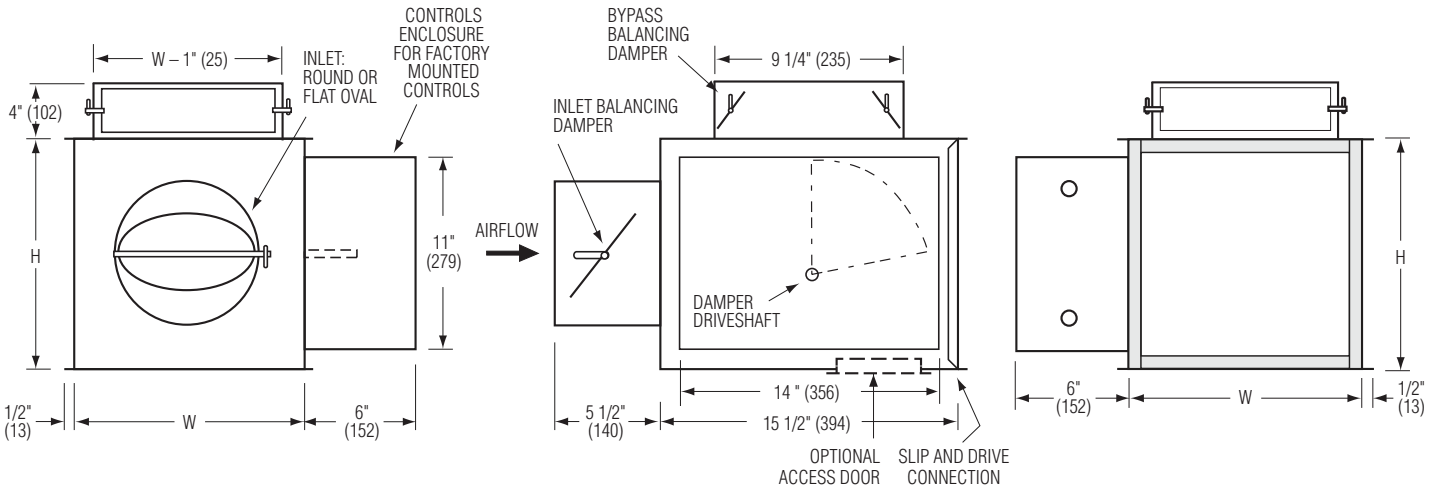

Pneumatic Controls

- Direct drive rotary pneumatic actuator. MCP-3631 Series. Minimum damper position must be field set.

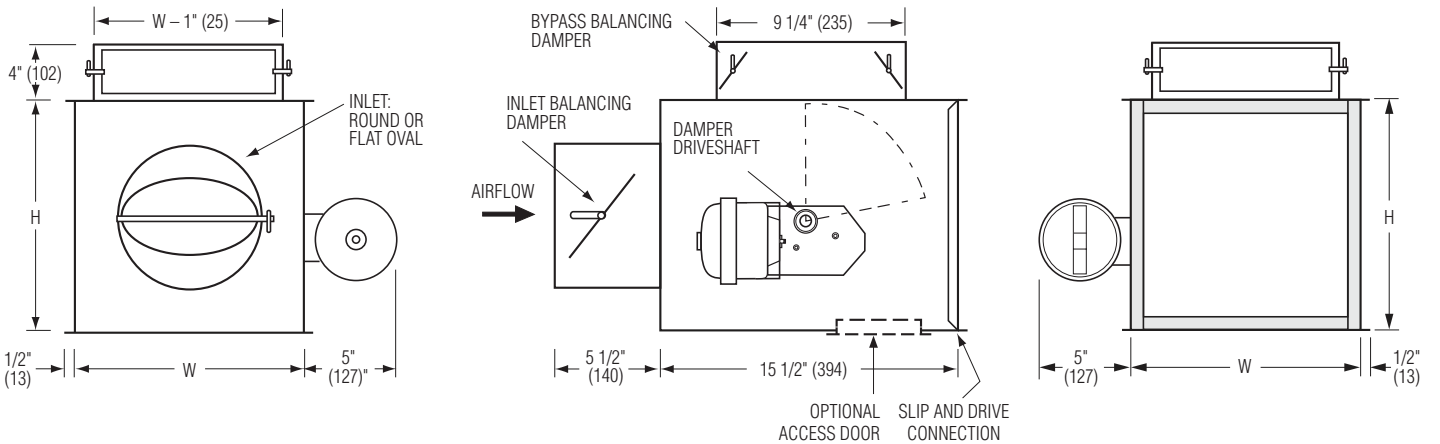

Dimensional Data

Unit Size	W	H	Inlet Size
6	10 (254)	12 1/2 (318)	5 7/8 (149) Round
8	12 (305)	12 1/2 (318)	7 7/8 (200) Round
10	14 (356)	12 1/2 (318)	9 7/8 (251) Round
12	18 (457)	12 1/2 (318)	12 15/16 x 9 13/16 (329 x 249) Oval
14	24 (610)	12 1/2 (318)	16 1/16 x 9 13/16 (408 x 249) Oval
16	28 (711)	12 1/2 (318)	19 3/16 x 9 13/16 (487 x 249) Oval

Dimensions

Model 3400 • Integral Sound Attenuator

- Single continuous length terminal construction minimizes casing leakage.
- Continuous internal insulation reduces insulation seams and minimizes airflow disturbance.
- Supplied with same liner as basic unit.

Analog Electronic and Digital Controls

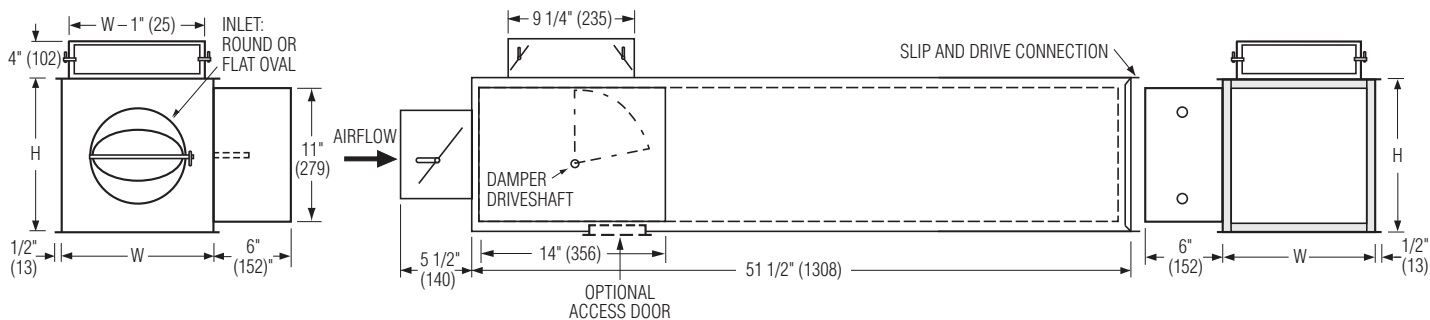

Pneumatic Controls

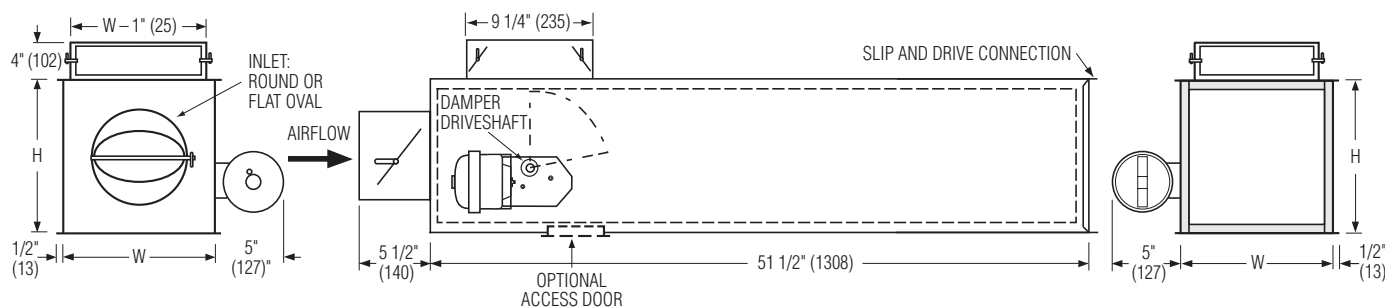

Dimensional Data

Unit Size	W	H	Inlet Size
6	10 (254)	12 1/2 (318)	5 7/8 (149) Round
8	12 (305)	12 1/2 (318)	7 7/8 (200) Round
10	14 (356)	12 1/2 (318)	9 7/8 (251) Round
12	18 (457)	12 1/2 (318)	12 15/16 x 9 13/16 (329 x 249) Oval
14	24 (610)	12 1/2 (318)	16 1/16 x 9 13/16 (408 x 249) Oval
16	28 (711)	12 1/2 (318)	19 3/16 x 9 13/16 (487 x 249) Oval

Dimensions

Model 34RW • Hot Water Reheat Coils

- One, two, three and four row available.
- Hot water coils have copper tubes and aluminum ripple fins. Coils have 1/2" (13) or 7/8" (22) O.D. sweat connections. Right or left hand coil connection is determined by looking through the terminal inlet in the direction of airflow.
- Galvanized steel casing with slip and drive discharge duct connection.
- AHRI Certified.
- Optional low leakage gasketed access door is recommended for coil access and cleaning.
- Performance data on page E15.

Analog Electronic and Digital Controls

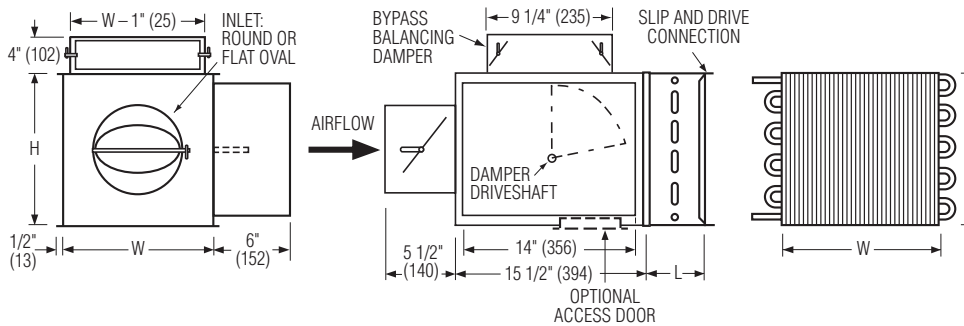

Pneumatic Controls

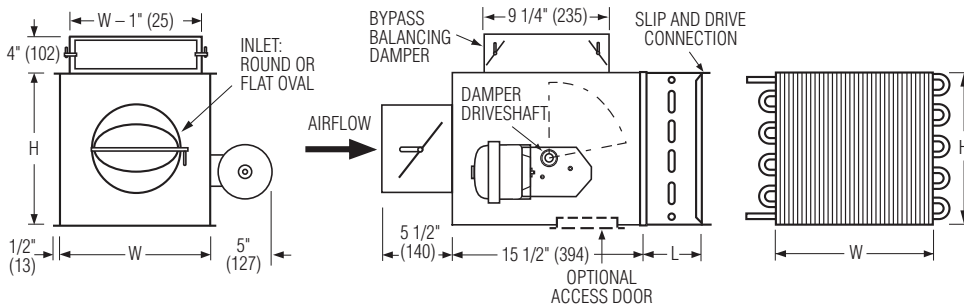

Dimensional Data

Unit Size	W	H	Hot Water Coil	
			L (1 & 2 row)	L (3 & 4 row)
6	10 (254)	12 1/2 (318)	5 (127)	7 1/2 (191)
8	12 (305)	12 1/2 (318)	5 (127)	7 1/2 (191)
10	14 (356)	12 1/2 (318)	5 (127)	7 1/2 (191)
12	18 (457)	12 1/2 (318)	5 (127)	7 1/2 (191)
14	24 (610)	12 1/2 (318)	5 (127)	7 1/2 (191)
16	28 (711)	12 1/2 (318)	5 (127)	7 1/2 (191)

Dimensions

Model 34RW • Integral Sound Attenuator plus Hot Water Reheat Coil

Analog Electronic and Digital Controls

- All the benefits of both the Integral Sound Attenuator and the Hot Water Coils shown on previous page in one.
- Full details and selection guide on Controls section of this catalog.

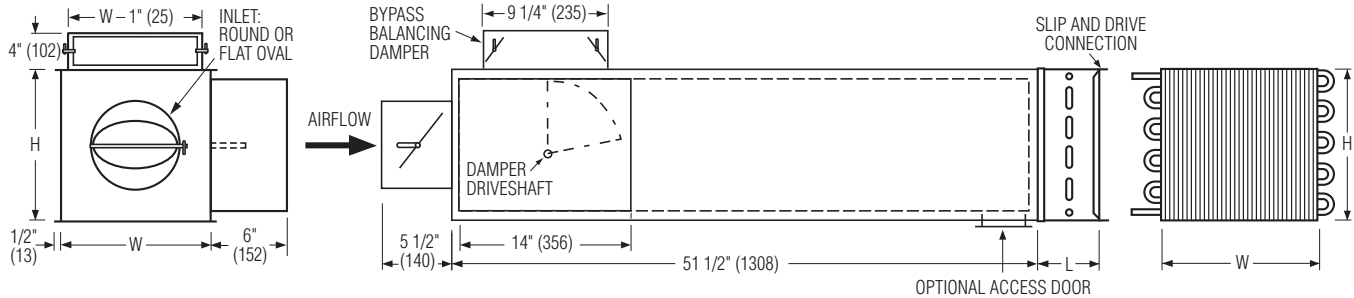

Model 34RE • Integral Electric Reheat

- Electric coil is factory mounted in an integral extended plenum section.
- Full details and selection guide on Controls section of this catalog.

Analog Electronic and Digital Controls

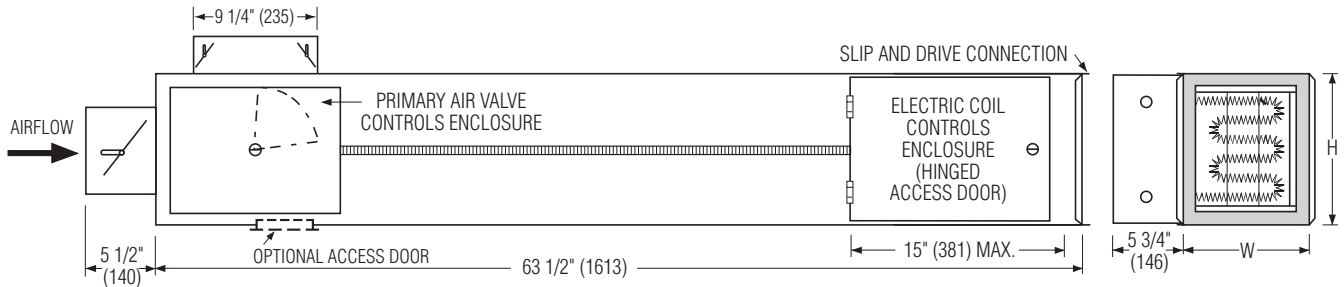

Pneumatic Controls

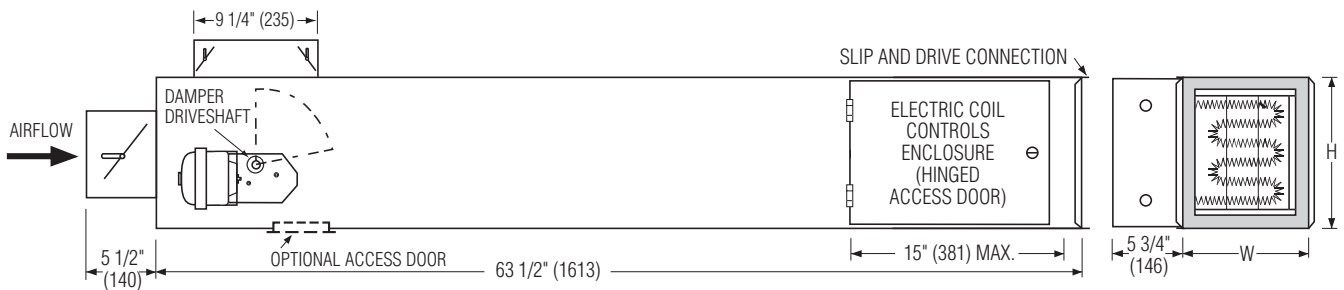

Dimensional Data

Unit Size	W	H	Inlet Size	Hot Water Coil	
				L (1 & 2 row)	L (3 & 4 row)
6	10 (254)	12 1/2 (318)	5 7/8 (149) Round	5 (127)	7 1/2 (191)
8	12 (305)	12 1/2 (318)	7 7/8 (200) Round	5 (127)	7 1/2 (191)
10	14 (356)	12 1/2 (318)	9 7/8 (251) Round	5 (127)	7 1/2 (191)
12	18 (457)	12 1/2 (318)	12 15/16 x 9 13/16 (329 x 249) Oval	5 (127)	7 1/2 (191)
14	24 (610)	12 1/2 (318)	16 1/16 x 9 13/16 (408 x 249) Oval	5 (127)	7 1/2 (191)
16	28 (711)	12 1/2 (318)	19 3/16 x 9 13/16 (487 x 249) Oval	5 (127)	7 1/2 (191)

BYPASS TERMINAL UNITS

Options:

Access Door

Ultra-low leakage, premium quality and performance. Flat oval design.

- Die formed 22 ga. (0.85) galvanized steel flanged frame and door panel.
- Positive bulb door seal.
- Plated steel camlock fasteners.
- 1" (25) insulation with 22 ga. (0.85) galvanized backing plate.
- Leakage tested in conformance with British Standard DW/142 Class C.
- See 0800-1 submittal for more detailed information.

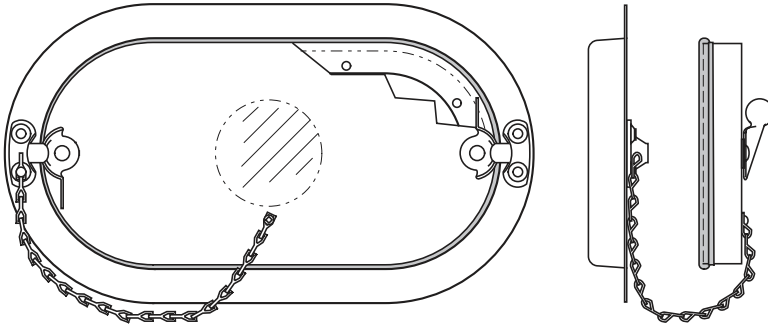

Terminal Unit Size	Nominal Door Size	Max. Leakage 8" w.g. (2 kPa) cfm
6, 8, 10, 12	8" x 5" (203 x 127)	0.036 cfm (1.02 l/min.)
14, 16	12" x 6" (305 x 152)	0.064 cfm (1.8 l/min.)

FF Round/Flat Oval Discharge Collar

- Same size as unit inlet.

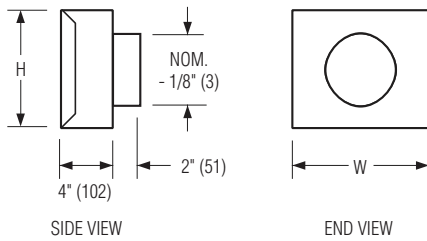

Unit Size	FF Nomonal Outlet Size	W	H
6	6" (152) Round	10" (254)	12 1/2" (318)
8	8" (203) Round	12" (305)	12 1/2" (318)
10	10" (254) Round	14" (356)	12 1/2" (318)
12	12" (305) Flat Oval	16" (406)	12 1/2" (318)
14	14" (356) Flat Oval	18" (457)	12 1/2" (318)
16	16" (406) Flat Oval	24" (610)	12 1/2" (318)

Accessories

Accessories ordered as separate models.

MOA Multi-Outlet Attenuator

MOA303 3' (916) Long

MOA305 5' (1524) Long

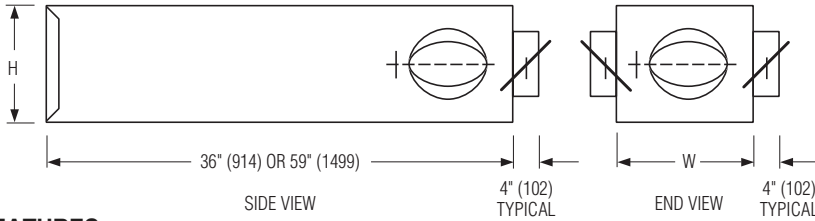

FEATURES:

- 22 ga. (0.86) galvanized steel construction, mechanically sealed, low leakage construction.
- All are supplied with slip and drive cleat duct connection.
- Shipped loose for field attachment.
- 3/4" (19) dual density insulation. Exposed edges coated to prevent erosion. Meets requirements of NFPA 90A and UL 181 standards.
- Denotes inlet airflow direction. →
- Only one outlet size to be specified per M.O.A. No mixing of outlet sizes on the same unit.
- Number and size of outlets on M.O.A. not to exceed the limits listed in table, both maximum quantity of outlets and maximum size of outlet.
- All round outlets include manual dampers with hand locking quadrant.
- For special outlet sizes and arrangements, consult your Nailor representative.

Unit Size	No. of Outlets	Outlet Size
6	1, 2, or 3	6 (152)
8	2, 3, 4 or 5	6, 8 (152, 203)
10	3, 4 or 5	8 (203)
	2, 3 or 4	10 (254)
12	4 or 5	8 (203)
	3, 4 or 5	10 (254)
14, 16	4 or 5	10 (254)

Unit Size	W	H
6	10" (254)	12 1/2" (318)
8	12" (305)	12 1/2" (318)
10	14" (356)	12 1/2" (318)
12	18" (457)	12 1/2" (318)
14	24" (610)	12 1/2" (318)
16	28" (711)	12 1/2" (318)

OPTIONS:

- Steri-Liner.
- Fiber-Free Liner.
- 1" (25) Fiberglass Liner.

Standard Outlet Arrangements

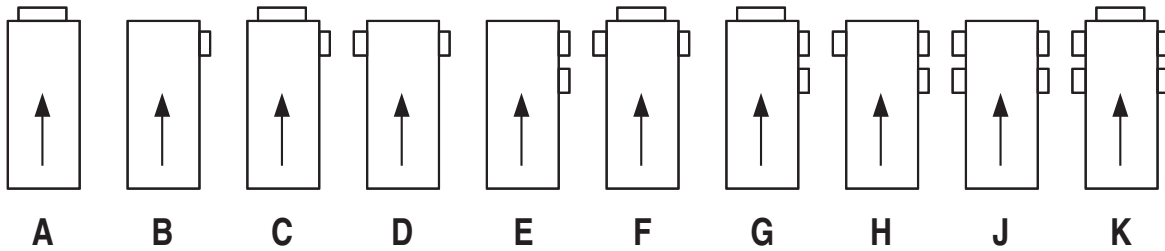

BYPASS TERMINAL UNITS

Performance Data • NC Level Application Guide
3400 Series

Inlet Size	Airflow		Min. Discharge ΔPs		Min. Bypass ΔPs		NC Levels		
							DISCHARGE	RADIATED	
								Bypass Closed	Bypass Open
cfm	l/s	"w.g.	Pa	"w.g.	Pa				
6	400	189	0.01	2	0.14	35	-	-	26
	300	142	0.01	2	0.08	20	-	-	-
	200	94	0.01	2	0.04	10	-	-	-
	100	47	0.01	2	0.01	2	-	-	-
8	700	330	0.01	2	0.21	52	-	-	30
	500	236	0.01	2	0.11	27	-	-	20
	350	165	0.01	2	0.05	12	-	-	-
	200	94	0.01	2	0.02	5	-	-	-
10	1100	519	0.01	2	0.43	107	-	20	37
	800	378	0.01	2	0.23	57	-	-	26
	500	236	0.01	2	0.09	22	-	-	-
	200	94	0.01	2	0.01	3	-	-	-
12	1600	755	0.01	2	0.50	124	-	21	41
	1200	566	0.01	2	0.28	70	-	-	33
	800	378	0.01	2	0.13	32	-	-	23
	400	189	0.01	2	0.03	7	-	-	-
14	2100	991	0.20	50	0.50	124	21	31	43
	1550	731	0.10	25	0.27	68	-	23	35
	1000	472	0.04	10	0.11	28	-	-	24
	450	212	0.01	2	0.02	5	-	-	-
16	2750	1298	0.12	29	0.50	124	21	34	47
	2050	967	0.06	16	0.28	70	-	24	38
	1350	637	0.03	8	0.12	30	-	-	28
	650	307	0.01	2	0.03	7	-	-	-

Performance Notes:

1. NC levels are calculated from the published raw data and based on procedures outlined in Appendix E, AHRI Standard 885.
2. Discharge sound attenuation deductions are based on environmental effect, duct lining, branch power division, insulated flex duct, end reflection and space effect and are as follows:

Discharge attenuation	Octave Band						
	2	3	4	5	6	7	
< 300 cfm	24	28	39	53	59	40	
300 – 700 cfm	27	29	40	51	53	39	
> 700 cfm	29	30	40	51	52	39	

3. Radiated sound attenuation deductions are based on a mineral tile ceiling and environmental effect and are as follows:

Radiated attenuation	Octave Band						
	2	3	4	5	6	7	
Total dB reduction	18	19	20	26	31	36	

4. Minimum discharge ΔPs is the static pressure loss through the unit with 100% airflow through discharge outlet.

5. Minimum bypass ΔPs is the static pressure loss through the unit with 100% airflow through the bypass outlet.
6. Dash (–) in space denotes an NC level of less than 20.
7. For a complete explanation and details on NC calculations, refer to page E14 and the engineering section of this catalog.

Performance Data • Sound Power Levels
3400 Series • Bypass
Fiberglass Liner



Inlet Size	Airflow		Min. Discharge ΔPs		Min Bypass ΔPs		Sound Power Octave Bands																	
							Discharge							Radiated										
														Bypass Closed							Bypass Open			
							cfm	l/s	"w.g.	Pa	"w.g.	Pa	2	3	4	5	6	7	2	3	4	5	6	7
6	400	189	0.01	2	0.14	35	63	59	55	50	42	40	42	37	33	24	20	20	54	55	52	52	51	37
	300	142	0.01	2	0.08	20	58	52	48	43	34	31	-	34	25	-	-	-	47	48	45	47	37	26
	200	94	0.01	2	0.04	10	56	46	41	34	23	20	-	-	-	-	-	-	-	38	34	32	-	-
	100	47	0.01	2	0.01	2	55	43	27	-	-	-	-	-	-	-	-	-	-	34	29	-	-	-
8	700	330	0.01	2	0.21	52	61	58	52	48	38	32	47	41	34	28	26	20	60	59	55	53	48	41
	500	236	0.01	2	0.11	27	57	49	43	38	27	20	43	34	27	-	-	-	52	50	46	43	30	28
	350	165	0.01	2	0.05	12	56	44	34	28	-	-	-	32	-	-	-	-	47	40	37	32	25	-
	200	94	0.01	2	0.02	5	56	43	-	-	-	-	-	-	-	-	-	-	43	30	-	-	-	-
10	1100	519	0.01	2	0.43	107	63	57	50	48	43	42	52	49	46	37	32	23	65	64	62	60	56	52
	800	378	0.01	2	0.23	57	59	50	44	40	35	33	49	43	39	28	26	-	56	55	52	50	46	41
	500	236	0.01	2	0.09	22	55	43	33	23	-	-	43	35	29	-	-	-	47	45	43	41	34	-
	200	94	0.01	2	0.01	3	53	42	-	-	-	-	-	-	-	-	-	-	42	30	-	-	-	-
12	1600	755	0.01	2	0.50	124	64	58	53	49	44	36	48	51	47	37	35	29	69	69	66	63	60	56
	1200	566	0.01	2	0.28	70	58	52	44	41	34	24	43	41	38	29	25	-	61	60	58	56	52	46
	800	378	0.01	2	0.13	32	54	44	33	28	-	-	40	33	29	-	-	-	50	49	49	46	39	31
	400	189	0.01	2	0.03	7	51	40	-	-	-	-	-	-	25	-	-	-	44	40	41	35	28	-
14	2100	991	0.20	49	0.50	124	70	64	58	53	50	45	54	58	56	49	49	41	69	69	67	65	61	57
	1550	731	0.10	25	0.27	68	62	55	50	45	41	33	48	50	49	42	40	29	62	62	60	57	53	48
	1000	472	0.04	10	0.11	28	56	45	37	32	26	-	44	40	38	29	-	-	51	50	50	45	40	31
	450	212	0.01	2	0.02	5	53	42	-	-	-	-	-	31	26	-	-	-	-	37	36	29	-	-
16	2750	1298	0.12	29	0.50	124	69	64	60	56	52	45	64	63	59	49	46	37	73	73	71	69	65	61
	2050	967	0.06	16	0.28	70	64	57	51	47	42	33	57	54	50	41	36	25	65	65	63	61	56	50
	1350	637	0.03	8	0.12	30	57	48	40	35	27	-	45	41	38	27	-	-	54	53	53	50	44	34
	650	307	0.01	2	0.03	7	54	44	32	28	22	-	-	-	-	-	-	-	40	35	33	25	-	-

For performance table notes, see page E13; highlighted numbers indicate embedded AHRI certification points.

Performance Data • AHRI Certification and Performance Notes
3400 Series • Bypass • AHRI Certification Rating Points
Fiberglass Liner

Inlet Size	Airflow		Min. Inlet ΔPs		Discharge Sound Power Levels						Radiated Sound Power Levels					
					@ 1.5" w.g. (375 Pa) ΔPs						@ 1.5" w.g. (375 Pa) ΔPs					
	cfm	l/s	"w.g.	Pa	Octave Band						Octave Band					
				2	3	4	5	6	7	2	3	4	5	6	7	
6	400	189	0.01	2	63	59	55	50	42	40	42	37	33	24	20	20
8	700	330	0.01	2	61	58	52	48	38	32	47	41	34	28	26	20
10	1100	519	0.01	2	63	57	50	48	43	42	52	49	46	37	32	23
12	1600	755	0.01	2	64	58	53	49	44	36	48	51	47	37	35	29
14	2100	991	0.20	50	70	64	58	53	50	45	54	58	56	49	49	41
16	2750	1298	0.12	29	69	64	60	56	52	45	64	63	59	49	46	37



Ratings are certified in accordance with AHRI Standards.

Performance Notes for Sound Power Levels:

1. Discharge sound power is the noise emitted from the unit discharge into the downstream duct. Discharge Sound Power Levels (SWL) now include duct end reflection energy as part of the standard rating. Including the duct end correction provides sound power levels that would normally be transmitted into an acoustically, non-reflective duct. The effect of including the energy correction to the discharge SWL, is higher sound power levels when compared to previous AHRI certified data. For more information on duct end reflection calculations see AHRI Standard 880.
2. Radiated sound power is the breakout noise transmitted through the unit casing walls.
3. Sound power levels are in decibels, dB re 10⁻¹² watts.
4. All sound data listed by octave bands is raw data without any corrections for room absorption or duct attenuation. Dash (-) in space indicates sound power level is less than 20 dB or equal to background.
5. Data derived from independent tests conducted in accordance with ANSI/ASHRAE Standard 130 and AHRI Standard 880.
6. Minimum discharge ΔPs is the static pressure loss through the unit with 100% airflow through discharge outlet.
7. Minimum bypass ΔPs is the static pressure loss through the unit with 100% airflow through the bypass outlet.

Performance Data Explanation

Sound Power Levels vs. NC Levels

The **Nailor Models: 3400, 34RW and 34RE** bypass terminal unit performance data is presented in two forms.

The laboratory obtained discharge and radiated sound power levels in octave bands 2 through 7 (125 through 4000 Hz) center frequency for each unit size at various flow rates and inlet static pressures is presented. This data is derived in accordance with ANSI/ASHRAE Standard 130 and AHRI Standard 880. This data is raw with no attenuation deductions and includes AHRI Certification standard rating points.

Nailor also provides an NC Level table as an application aid in terminal selection, which includes attenuation allowances as explained below. The suggested attenuation allowances are typical not representative of specific job site conditions. It is recommended that the sound power level data be used and a detailed NC calculation be performed using the procedures outlined in AHRI Standard 885, Appendix E for accurate space sound levels.

Explanation of NC Levels

Tabulated NC levels are based on attenuation values as outlined in AHRI Standard 885 "Procedure for Estimating Occupied Space Sound Levels in the Application of Air Terminals and Air Outlets". AHRI Standard 885, Appendix E provides typical sound attenuation values for air terminal discharge sound and air terminal radiated sound.

As stated in AHRI Standard 885, Appendix E, "These values can be used as a quick method of estimating space sound levels when a detailed evaluation is not available. The attenuation values are required for use by manufacturers to catalog application sound levels. In product catalogs, the end user environments are not known and the following factors are provided as typical attenuation values. Use of these values will allow better comparison between manufacturers and give the end user a value which will be expected to be applicable for many types of space."

Radiated Sound

Table E1 of Appendix E provides radiated sound attenuation values for three types of ceiling: Type 1 – Glass Fiber; Type 2 – Mineral Fiber; Type 3 – Solid Gypsum Board.

Since Mineral Fiber tile ceilings are the most common construction used in commercial buildings, these values have been used to tabulate Radiated NC levels.

The following table provides the calculation method for the radiated sound total attenuation values based on AHRI Standard 885.

	Octave Band					
	2	3	4	5	6	7
Environmental Effect	2	1	0	0	0	0
Ceiling/Space Effect	16	18	20	26	31	36
Total Attenuation Deduction	18	19	20	26	31	36

The ceiling/space effect assumes the following conditions:

1. 5/8" (16) tile, 20 lb/ft³ (320 kg/m³) density.
2. The plenum is at least 3 feet (914) deep.
3. The plenum space is either wide (over 30 feet [9 m]) or lined with insulation.
4. The ceiling has no significant penetration directly under the unit.

Discharge Sound

Table E1 of Appendix E provides typical discharge sound attenuation values for three sizes of terminal unit.

1. Small box; Less than 300 cfm (142 l/s)
(Discharge Duct 8" x 8" [203 x 203]).
2. Medium box; 300 – 700 cfm (142 - 330 l/s)
(Discharge Duct 12" x 12" [305 x 305]).
3. Large box; Greater than 700 cfm (330 l/s)
(Discharge Duct 15" x 15" [381 x 381]).

These attenuation values have been used to tabulate Discharge NC levels applied against the terminal airflow volume and not terminal unit size.

The following tables provide the calculation method for the discharge sound total attenuation values based on AHRI Standard 885.

Small Box <300 cfm	Octave Band					
	2	3	4	5	6	7
Environmental Effect	2	1	0	0	0	0
5 ft. (1.5 m) 1" (25) Duct Lining	2	6	12	25	29	18
Branch Power Division (1 outlet)	0	0	0	0	0	0
5 ft. (1.5 m), 8 in. dia. (203) Flex Duct	5	10	18	19	21	12
End Reflection	10	5	2	1	0	0
Space Effect	5	6	7	8	9	10
Total Attenuation Deduction	24	28	39	53	59	40

Medium Box 300 – 700 cfm	Octave Band					
	2	3	4	5	6	7
Environmental Effect	2	1	0	0	0	0
5 ft. (1.5 m) 1" (25) Duct Lining	2	4	10	20	20	14
Branch Power Division (2 outlets)	3	3	3	3	3	3
5 ft. (1.5 m), 8 in. dia. (203) Flex Duct	5	10	18	19	21	12
End Reflection	10	5	2	1	0	0
Space Effect	5	6	7	8	9	10
Total Attenuation Deduction	27	29	40	51	53	39

Large Box >700 cfm	Octave Band					
	2	3	4	5	6	7
Environmental Effect	2	1	0	0	0	0
5 ft. (1.5 m) 1" (25) Duct Lining	2	3	9	18	17	12
Branch Power Division (3 outlets)	5	5	5	5	5	5
5 ft. (1.5 m), 8 in. dia. (203) Flex Duct	5	10	18	19	21	12
End Reflection	10	5	2	1	0	0
Space Effect	5	6	7	8	9	10
Total Attenuation Deduction	29	30	41	51	52	39

1. Flexible duct is non-metallic with 1" (25) insulation.
2. Space effect (room size and receiver location) 2500 ft.³ (69 m³) and 5 ft. (1.5 m) distance from source.

For a complete explanation of the attenuation factors and the procedures for calculating room NC levels, please refer to the acoustical engineering guidelines at the back of this catalog and AHRI Standard 885.

Performance Data • Hot Water Coil

Model: 34RW

Unit Size 6

1 Row (single circuit)

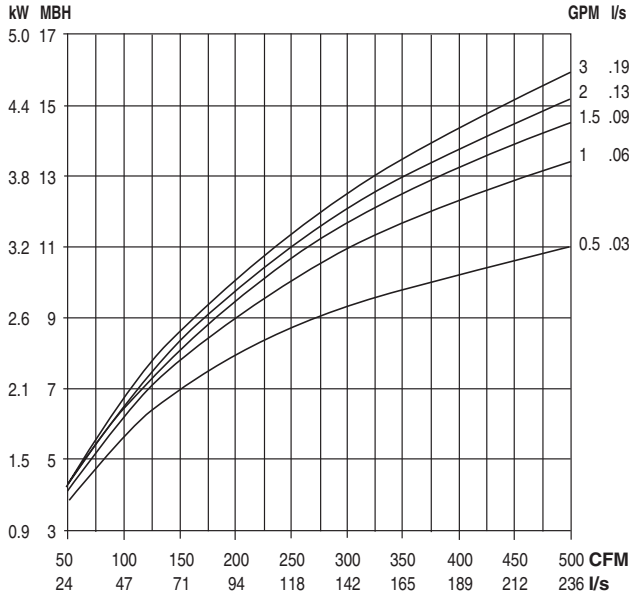

2 Row (multi-circuit)

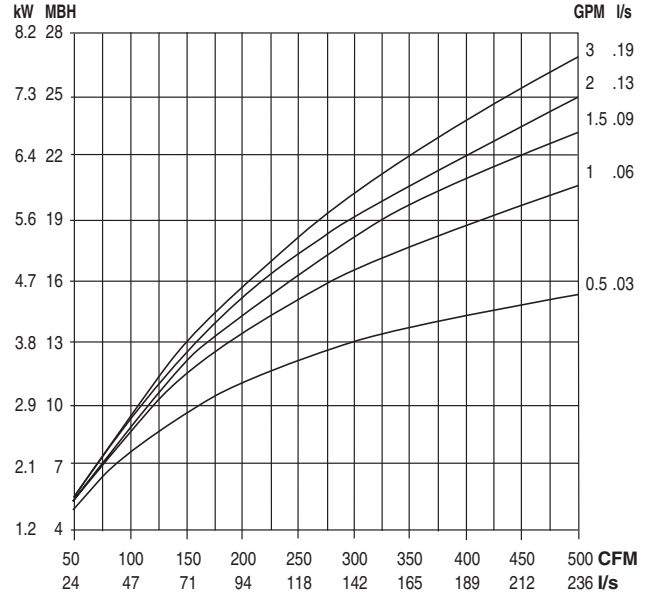

Unit Size 8

1 Row (single circuit)

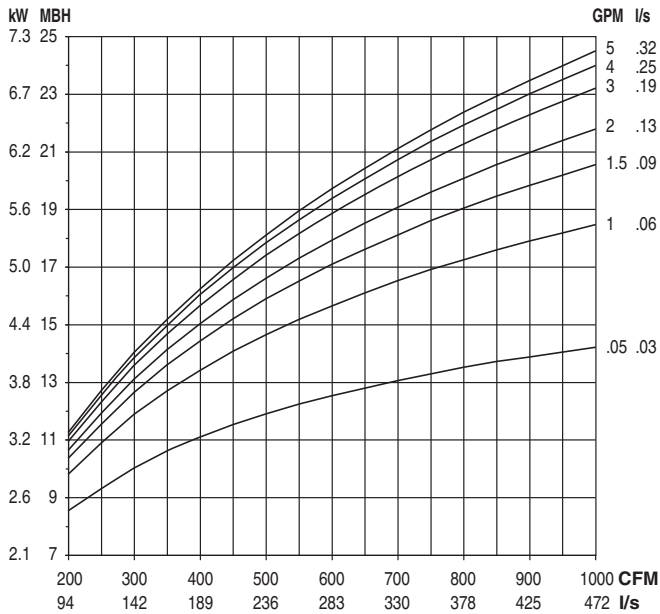

2 Row (multi-circuit)

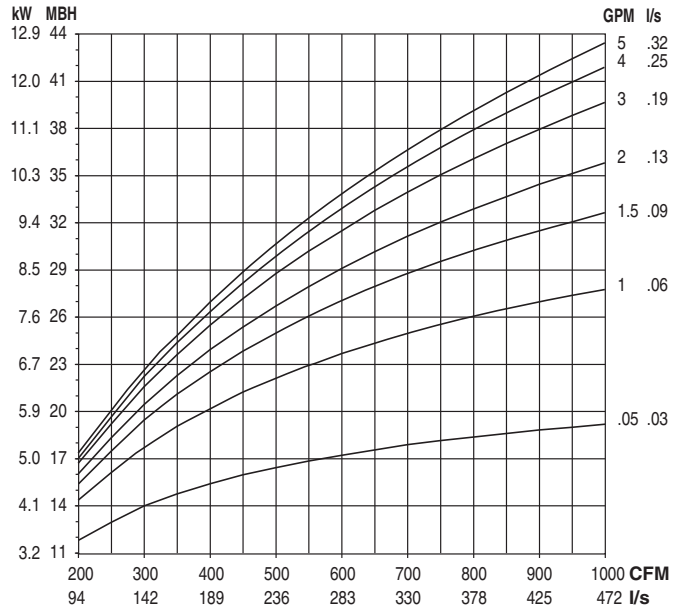

NOTES:

- Capacities are in MBH (kW), *thousands of Btu per hour (kiloWatts)*.
- MBH (kW) values are based on a Δt (temperature difference) of 125°F (69°C) between entering air and entering water. For other Δt 's; multiply the MBH (kW) values by the factors below.

- Air Temperature Rise.

$$\text{ATR (°F)} = 927 \times \frac{\text{MBH}}{\text{cfm}}, \text{ ATR (°C)} = 829 \times \frac{\text{kW}}{\text{l/s}}$$

- Water Temp. Drop.

$$\text{WTD (°F)} = 2.04 \times \frac{\text{MBH}}{\text{GPM}}, \text{ WTD (°C)} = .224 \times \frac{\text{kW}}{\text{l/s}}$$

- Connections: 1 Row 1/2" (13), 2, 3 and 4 Row 7/8" (22); O.D. male solder.

Altitude Correction Factors:

Altitude ft. (m)	Sensible Heat Factor
0 (0)	1.00
2000 (610)	0.94
3000 (914)	0.90
4000 (1219)	0.87
5000 (1524)	0.84
6000 (1829)	0.81
7000 (2134)	0.78

Correction factors at other entering conditions:

Δt °F (°C)	40 (22)	50 (28)	60 (33)	70 (39)	80 (44)	90 (50)	100 (56)	110 (61)	125 (69)	140 (78)	160 (89)	180 (100)
Factor	.320 (.319)	.400 (.406)	.480 (.478)	.560 (.565)	.640 (.638)	.720 (.725)	.800 (.812)	.880 (.884)	1.00 (1.00)	1.12 (1.13)	1.28 (1.29)	1.44 (1.45)

Performance Data • Hot Water Coil

Model: 34RW

Unit Size 10

1 Row (single circuit)

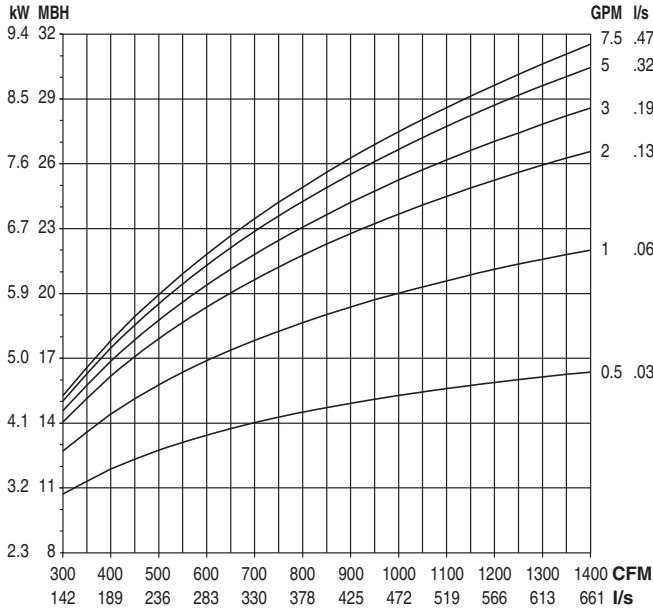

2 Row (multi-circuit)

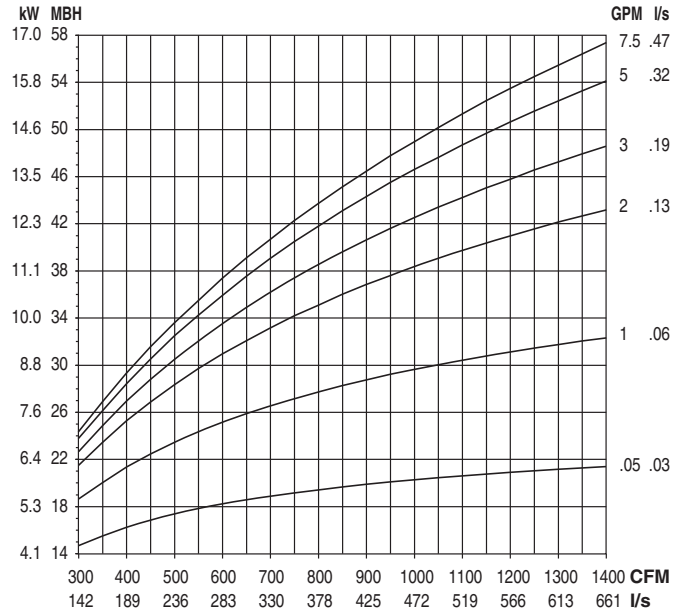

Unit Size 12

1 Row (single circuit)

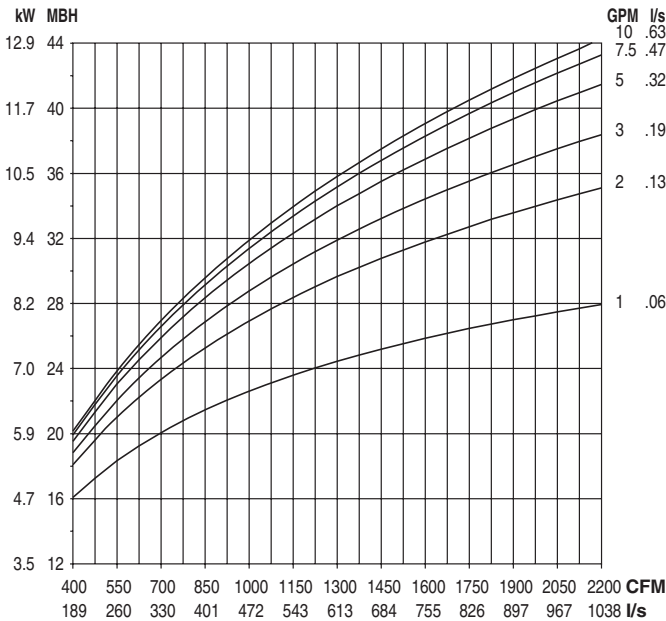

2 Row (multi-circuit)

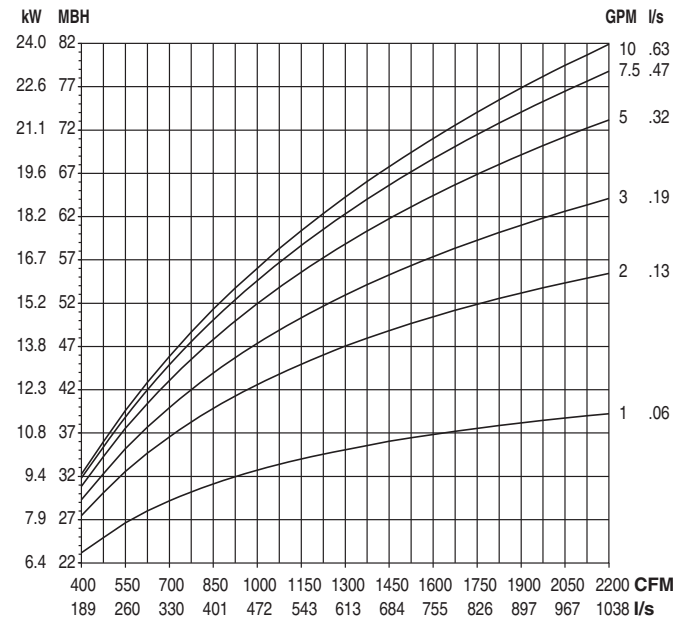

NOTES:

- Capacities are in MBH (kW), *thousands of Btu per hour (kiloWatts)*.
- MBH (kW) values are based on a Δt (temperature difference) of 125°F (69°C) between entering air and entering water. For other Δt 's; multiply the MBH (kW) values by the factors below.

- Air Temperature Rise.
 $ATR (^\circ F) = 927 \times \frac{MBH}{cfm}$, $ATR (^\circ C) = 829 \times \frac{kW}{l/s}$
- Water Temp. Drop.
 $WTD (^\circ F) = 2.04 \times \frac{MBH}{GPM}$, $WTD (^\circ C) = .224 \times \frac{kW}{l/s}$
- Connections: 1 Row 1/2" (13), 2, 3 and 4 Row 7/8" (22); O.D. male solder.

Altitude Correction Factors:

Altitude ft. (m)	Sensible Heat Factor
0 (0)	1.00
2000 (610)	0.94
3000 (914)	0.90
4000 (1219)	0.87
5000 (1524)	0.84
6000 (1829)	0.81
7000 (2134)	0.78

Correction factors at other entering conditions:

Δt °F (°C)	40 (22)	50 (28)	60 (33)	70 (39)	80 (44)	90 (50)	100 (56)	110 (61)	125 (69)	140 (78)	160 (89)	180 (100)
Factor	.320 (.319)	.400 (.406)	.480 (.478)	.560 (.565)	.640 (.638)	.720 (.725)	.800 (.812)	.880 (.884)	1.00 (1.00)	1.12 (1.13)	1.28 (1.29)	1.44 (1.45)

BYPASS TERMINAL UNITS

Performance Data • Hot Water Coil

Model: 34RW

Unit Size 14

1 Row (single circuit)

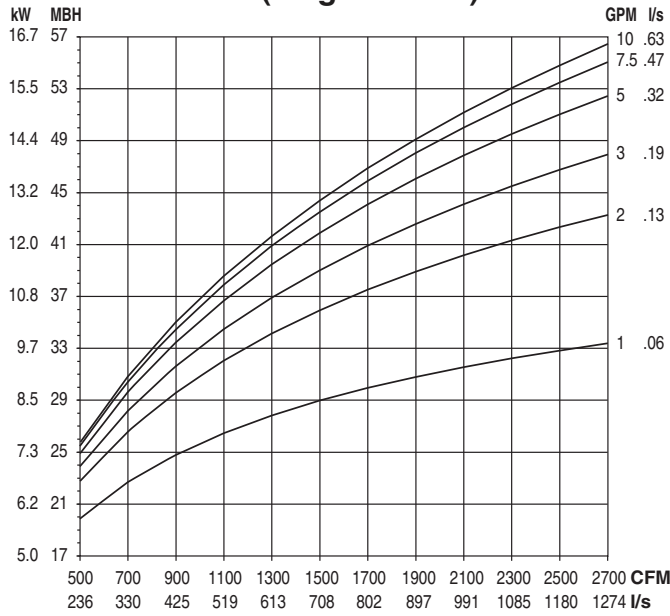

2 Row (multi-circuit)

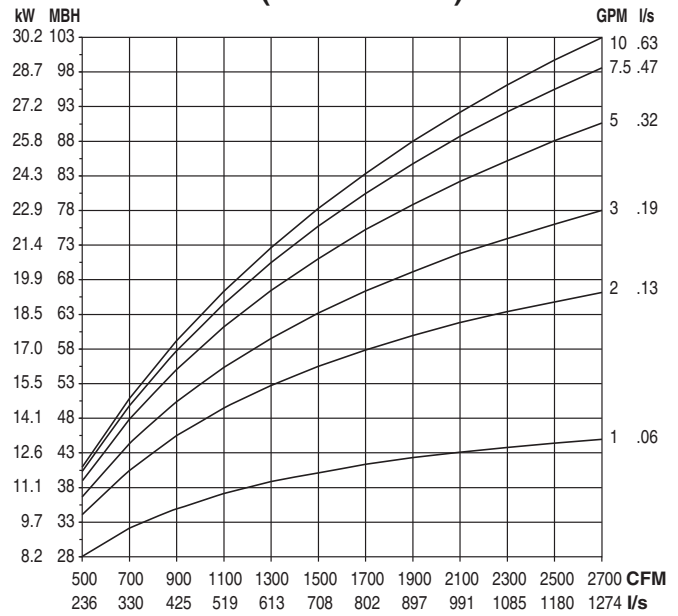

Unit Size 16

1 Row (single circuit)

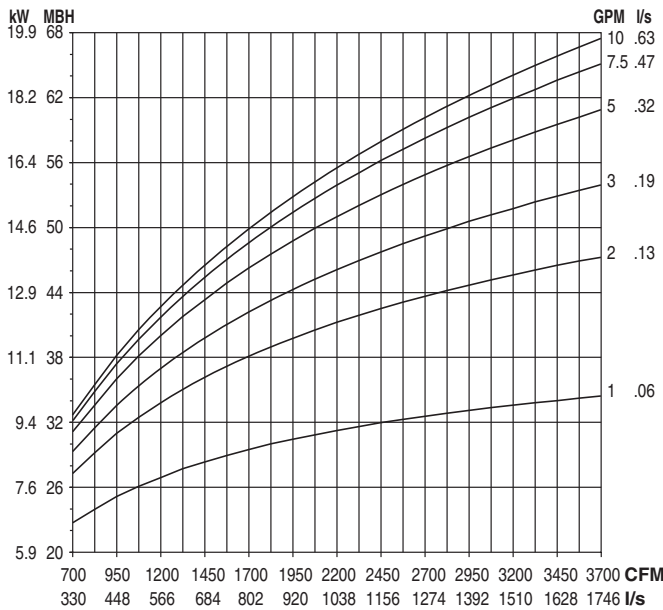

2 Row (multi-circuit)

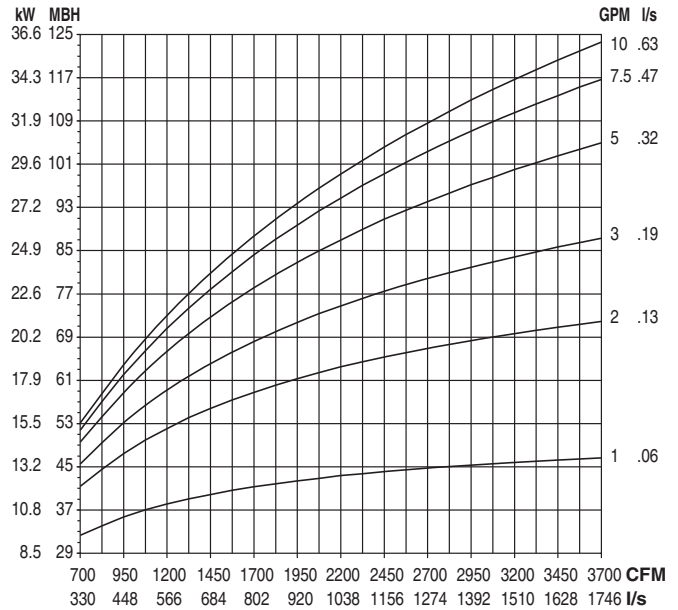

NOTES:

- Capacities are in MBH (kW), **thousands of Btu per hour (kiloWatts)**.
- MBH (kW) values are based on a Δt (temperature difference) of 125°F (69°C) between entering air and entering water. For other Δt 's; multiply the MBH (kW) values by the factors below.

- Air Temperature Rise.

$$\text{ATR (}^\circ\text{F)} = 927 \times \frac{\text{MBH}}{\text{cfm}}, \text{ ATR (}^\circ\text{C)} = 829 \times \frac{\text{kW}}{\text{l/s}}$$

- Water Temp. Drop.

$$\text{WTD (}^\circ\text{F)} = 2.04 \times \frac{\text{MBH}}{\text{GPM}}, \text{ WTD (}^\circ\text{C)} = .224 \times \frac{\text{kW}}{\text{l/s}}$$

- Connections: 1 Row 1/2" (13), 2, 3 and 4 Row 7/8" (22); O.D. male solder (Unit Size 14). 1, 2, 3 and 4 Row 7/8" (22); O.D. male solder (Unit Size 16)

Altitude Correction Factors:

Altitude ft. (m)	Sensible Heat Factor
0 (0)	1.00
2000 (610)	0.94
3000 (914)	0.90
4000 (1219)	0.87
5000 (1524)	0.84
6000 (1829)	0.81
7000 (2134)	0.78

Correction factors at other entering conditions:

Δt °F (°C)	40 (22)	50 (28)	60 (33)	70 (39)	80 (44)	90 (50)	100 (56)	110 (61)	125 (69)	140 (78)	160 (89)	180 (100)
Factor	.320 (.319)	.400 (.406)	.480 (.478)	.560 (.565)	.640 (.638)	.720 (.725)	.800 (.812)	.880 (.884)	1.00 (1.00)	1.12 (1.13)	1.28 (1.29)	1.44 (1.45)

Performance Data • Hot Water Coil • Pressure Drops

Model: 34RW

Unit Size 6

Unit Size 8

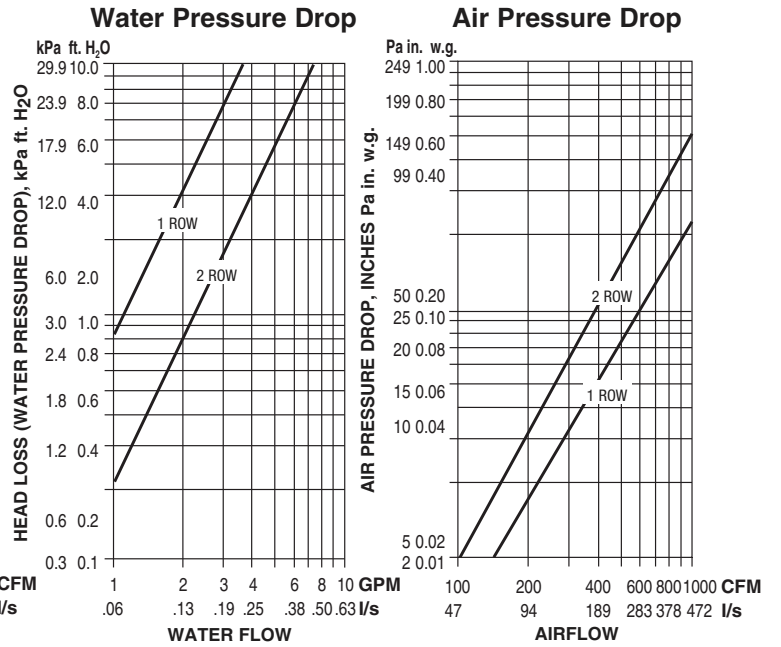
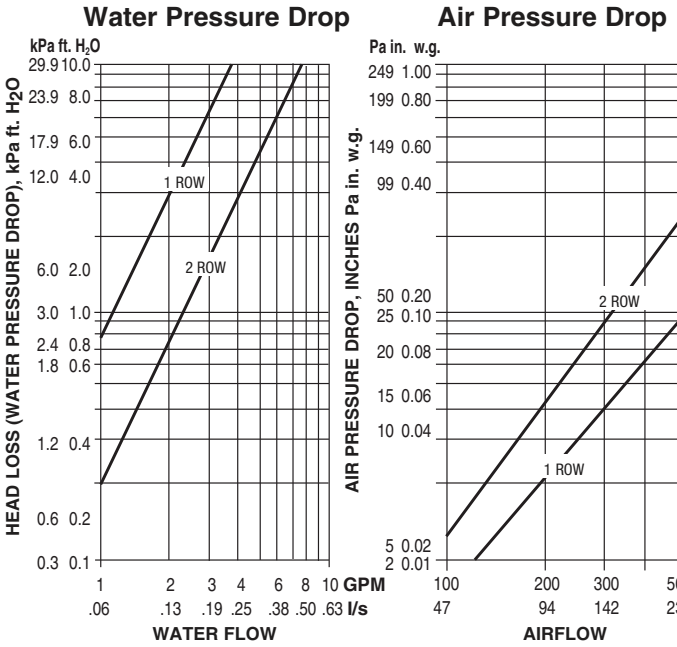

Unit Size 10

Unit Size 12

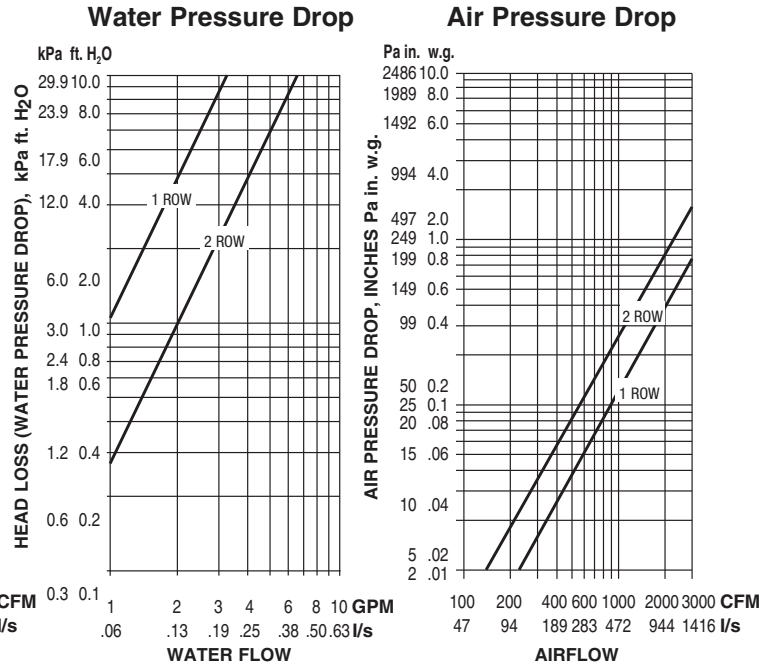
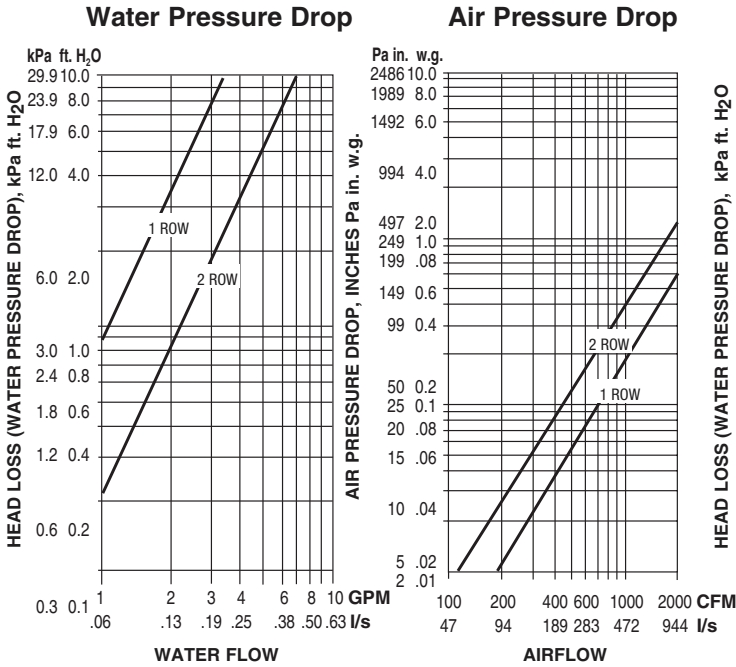

BYPASS TERMINAL UNITS

Performance Data • Hot Water Coil • Pressure Drops

Models: 34RW

Unit Size 14

Unit Size 16

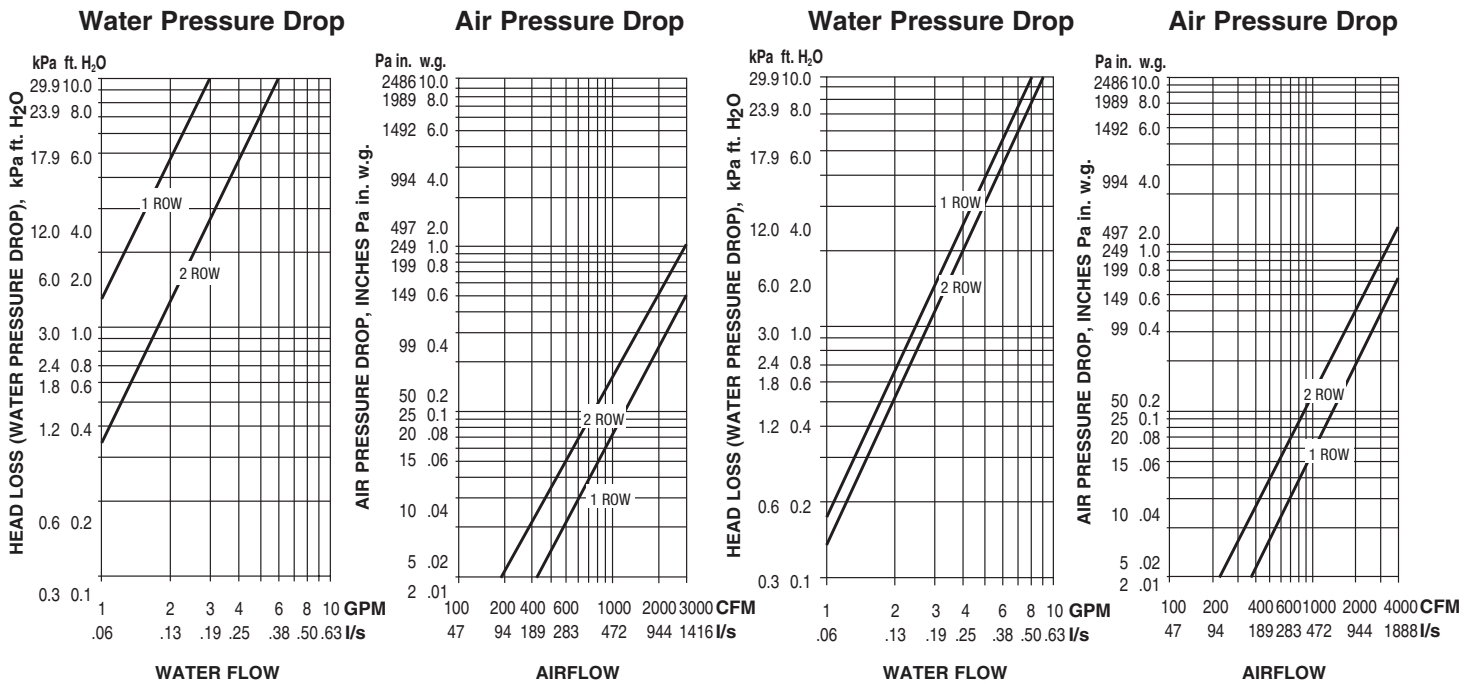

Metric Conversion Factors:

1. Water Flow (liters per second)
l/s = gpm x 0.6309
2. Water Head Loss (kilopascals):
kPa = ft. w.g. x 2.9837
3. Airflow Volume (liters per second)
l/s = cfm x 0.472
4. Air Pressure Drop (Pascals):
Pa = in. w.g. x 248.6
5. Heat (kiloWatts):
kW = MBH x 0.293

Electric Heating Coils Selection, Capacities and Features

Model: 34RE

Nailor manufactures its own electric heating coils. They have been specifically designed and tested for use with pressure dependent, single duct bypass units.

Nailor electric coils are factory mounted as an integral part of the terminal unit in an insulated extended plenum section, located sufficiently downstream to ensure even airflow over the coil elements. Total length of the casing including heater terminal is only 31" (787), providing a compact, easy to handle unit. Freight costs are therefore also reduced. The unique inclined opposed blade damper design provides improved and more even airflow over the coil elements compared with round butterfly damper designs, which helps to minimize air stratification, avoid nuisance tripping of the thermal cut-outs and maximize heat pick-up.

For dimensional data, see page E8.

Selection Guidelines:

The table below provides a general guideline as to the voltages and maximum kiloWatts available for each terminal unit size. Up to three stages of heat are available. A minimum of 0.5 kW/ stage is required.

For optimum diffuser performance and maximum thermal comfort, ASHRAE recommends that discharge temperatures do not exceed 15°F (8°C) above room set point, as stratification and short circuiting may occur. ASHRAE Standard 62.1 limits discharge temperatures to 90°F (32°C) or increasing the ventilation rate when heating from the ceiling. Never select kW to exceed a discharge temperatures of 115°F (46°C).

$$\Delta T \text{ (Air Temp. Rise, } ^\circ\text{F)} = \frac{\text{kW} \times 3160}{\text{cfm}}$$

The coil ranges listed are restricted to a maximum of 48 amps and do not require circuit fusing to meet NEC code requirements. Total pressure at the airflow switch should be at least 0.07" w.g. (17 Pa) to ensure correct coil operation and avoid possible nuisance tripping of the thermal cutouts due to insufficient airflow over the coil elements. Check that desired minimum airflow is within recommended operating range.

Standard Features:

- Primary auto-reset high limit thermal cut-out (one per coil in control circuit).
- Secondary manual reset high limit thermal cut-outs (one per element).
- Positive pressure airflow switch.
- Class A 80/20 nickel-chrome alloy heating elements.
- Magnetic or safety contactors and/or PE switches as required.
- Control transformer. Class II, 24 Vac for digital and analog controls.
- Line terminal block.
- Hinged door control enclosure.
- High grade rib type ceramic insulator.
- Slip and drive discharge connection.
- Class A 80/20 wire.



Electric Heater

Options:

- Quiet contactors.
- Mercury contactors.
- Toggle type disconnect switch.
- Door interlock disconnect switch.
- Power circuit fusing.
- Dust tight construction.
- SCR control.

Electric Coil Limitations

Unit Size	Heating Range* cfm	Maximum kW						
		Single Phase				Three phase		
		120V	208V	277V	377V	208V	480V	600V
6	Min - 400	5.5	7.5	7.5	7.5	7.5	7.5	7.5
8	Min - 700	5.5	9.5	13.0	13.0	13.0	13.0	13.0
10	Min - 1100	5.5	9.5	13.0	16.5	17.0	21.0	21.0
12	Min - 1600	5.5	9.5	13.0	16.5	17.0	30.0	30.0
14	Min - 2100	5.5	9.5	13.0	16.5	17.0	31.0	38.5
16	Min - 2750	5.5	9.5	13.0	16.5	17.0	31.0	38.5

* Minimum required airflow is 70 cfm per kilowatt (33 l/s/kW)
The minimum airflow requires field setting using the mechanical minimum stop on the damper actuator.



Intertek

Tested and approved to the following standards:

ANSI/UL
1996, 4th ed.
CSA C22.2
No. 155-M1986.

Balancing Procedure

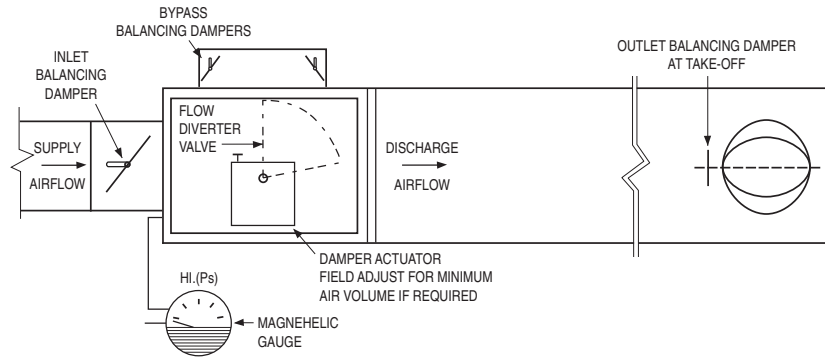

This balancing procedure assumes that the fan supplying the system maintains a constant static pressure in the supply duct to the terminal unit. Bypass terminal units are pressure dependent and will need rebalancing if system duct static pressure changes.

The 3400 series are shipped with both inlet and bypass balancing dampers as standard to permit ease of field balancing and to ensure accurate adjustment and optimum operation.

1. Fully open the dampers of all supply outlets on the discharge duct from the terminal unit.
2. Place terminal in the full open position, supplying 100% air to the occupied space by adjusting the thermostat to full cooling.
3. Adjust the balancing damper located in the terminal inlet to provide the required total airflow.
4. Starting with the outlet furthest downstream, adjust the damper of each air outlet to the required air volume.
5. Take a static pressure reading at the terminal unit after the inlet damper, using a magnehelic gauge or equivalent.
6. Adjust the room thermostat to full heating to provide 100% bypass airflow or the minimum air volume to the room, if a mechanical minimum air volume stop is utilized. An indicator mark on the end of the driveshaft shows damper position, 90° rotation CW to close.
7. Adjust the bypass outlet damper(s) on the terminal until the static pressure reading equals that obtained in step 5.
8. Re-adjust the room thermostat to the desired setpoint temperature. The terminal is now balanced.

1. Direct acting/normally closed damper connection: Disconnect control air to actuator. Ensure damper and actuator are in alignment. Damper should be fully closed.

- (a) Using mechanical minimum stop. Adjust screw to back-off damper to required minimum airflow position.
- (b) Using damper end stops (no mech. minimum stop provided). Loosen collar set and bushing on damper shaft. Rotate damper shaft CCW to desired minimum airflow position and re-tighten actuator connection.

2. Reverse acting/normally open damper connection:

- (a) Using stroke stop screw. Apply 20 psi main air to actuator. Insert screw (by others) and back-off damper to required minimum airflow position.
- (b) Using damper end stops (no built-in stroke stop screw). Loosen damper/actuator collar set and bushing coupling. Apply 20 psi main air to actuator. When actuator reaches the end of its rotation, rotate damper shaft CCW to desired minimum airflow position and re-tighten on shaft.

Electric Actuators

KMC MEP-4003 (standard). Position damper to the full open position. Depress the gear disengagement button and position the drive collar so the indicator mark is at the "90" mark. Tighten setscrews on shaft. Loosen lower travel stop one-half turn and slide to desired position. Tighten stop screw.

Mechanical Minimum Stop Field Setting Procedure Pneumatic Actuator (MCP-3631 Series)

Actuator rotation is 100°. Angle of rotation can be limited by inserting a 1/4" – 20 stroke stop screw into front end of actuator and securing with a lock nut (field supplied by user). Length of screw is unimportant as long as it has adequate thread length. Damper rotates 90°, CW to close and has built in end stops.

Desired Rotation	Insertion of Stop Screw
95°	0.520" (13.2)
85°	0.700" (17.8)
75°	0.875" (22.2)
65°	1.050" (26.7)
55°	1.220" (40.0)
45°	1.400" (35.6)

NOTES:



BYPASS TERMINAL UNITS

CONTROLS



TABLE OF CONTENTS

	Page No.
Direct Digital Controls (DDC)	
Direct Digital Controls	F3
Nailor EZvav	F3
Factory Mounting Authorization Program	F5
Standard Control Sequences	
• Single Duct Terminal Units	F6
• Dual Duct Terminal Units	F8
• Fan Powered Terminal Units	F9
Analog Electronic Controls	
Pressure Dependent Control	F15
Pressure Independent Control	F15
Standard Control Sequences	
• Single Duct Terminal Units	F17
• Dual Duct Terminal Units	F19
• Fan Powered Terminal Units	F20
• Bypass Terminal Units	F23
Pneumatic Controls	
Pressure Dependent Control	F27
Pressure Independent Control	F27
Standard Control Sequences	
• Single Duct Terminal Units	F29
• Dual Duct Terminal Units	F31
• Fan Powered Terminal Units	F32
• Bypass Terminal Units	F34
Electric Heater Controls	F35
Electric Heating Coils	F36

Direct Digital Controls (DDC)

Microprocessor based technology is now commonplace in HVAC building management systems, particularly in larger building applications. Most controls companies have therefore developed DDC controllers and software programs for terminal units, to enhance energy efficient VAV systems and the well proven associated control strategies. VAV digital controllers are only one part of a much larger fully integrated building management system and the common availability and specification of terminal unit DDC controllers from control companies ensures compatibility and common protocol for trouble-free systems communication, maintenance support and trouble shooting. Digital VAV controls offer all the advantages of accurate, pressure independent operation plus the additional benefits of a networking capability and two-way communication. Parameters can be loaded and downloaded via communication with a remote PC.

Nailor has extensive experience factory mounting digital controls supplied by the temperature control contractor. Nailor has developed individual factory mounting programs for most manufacturers currently offering digital controls, providing the assurance of a high quality, professional installation and minimizing start-up problems.

Nailor has designed its terminal units to be generic in nature and compatible with all DDC controllers.

- Nailor supplies as standard a NEMA 1 full controls enclosure for protection of the controls during shipment, installation and for the life of the building HVAC system. Dust tight construction is an option.
- The vast majority of digital controls require a flow sensor. Nailor's Diamond Flow multi-point averaging sensor is compatible with all such controls. Nailor will mount its own sensor as standard, whether the digital controls are to be factory or field mounted, ensuring accurate measurement regardless of inlet conditions. Factors have been developed for loading into the flow control algorithm.
- UL Class 2 control transformers and disconnect switches are available from Nailor factory installed. All components carrying 120 VAC or higher should be supplied and installed by Nailor in order to maintain ETL listings.
- Separate isolation control transformers are available on fan terminal units to protect digital components from potentially harmful voltage spikes.
- An economical factory approved tri-state 24 VAC, 40 in. - lb. (4.5 Nm) torque direct drive actuator is available from Nailor when the DDC controller being mounted is available for use with a separate actuator.

Models: MEP-4003 60°/minute
MEP-5061 18°/minute



Optional Nailor supplied and mounted 'Tri-state' Series Actuator.

Nailor EZvav Digital Controls

The EZvav Digital Controls by Nailor bring simplicity to the Variable Air Volume (VAV) terminal unit market. Designed for both stand-alone applications and for integration with BACnet building automation systems, EZvav are precise P+I pressure independent VAV controllers that are pre-configured for standard control sequences that cover the vast majority of terminal unit applications.

All terminal units with electric or hot water heating coils are supplied as standard with a DAT Discharge Air Temperature control sensor that can limit the discharge air temperature to a maximum of 15°F above room set point, helping compliance with ASHRAE Standard 62.1 and 55.

Field commissioning and balancing can all be performed using the standard digital display room temperature sensor, which has an intuitive menu driven setup. No laptop, expansion modules, communication interface or software is required.



EZvav Digital Controls

Nailor EZvav Digital Controls (continued)

Features & Benefits:

- Integrated controller/actuator/transducer.
- Factory mounted and wired for new building applications.
- Ideal for retrofitting and upgrading pneumatic and analog controls to a digital solution.
- Room temperature sensor (thermostat) options include Digital Display, Occupancy Sensor and compact Rotary Dial models.
- Remote fan volume adjustment from 0 – 100% for EPIC ECM fan powered terminals.
- Simple menu driven setup.
- BACnet BMS network integration ready.

Application Control Sequences Include:

- Single Duct VAV or CAV Cooling only and Heat/Cool Changeover.
- Single Duct VAV Cooling with reheat.
- Dual Duct Variable Volume or Constant Volume control.
- Series Fan Powered Constant Volume with/without supplementary heat.
- Parallel Fan Powered Variable Volume with/without supplementary heat.

Heating Control Options:

Binary (up to 3 stages of electric heat), Modulating (0 – 10 Vdc analog) or Floating heat control.

Native BACnet

All models are BACnet Applications Specific Controllers that are ready to connect to a BACnet MS/TP network. Device instance, MAC address and baud rate are set from an STE-8001W36 without special software.

EZ to order

Nailor Representatives' Automated Pricing Program (RAPP) features EZ quick select options for control sequences and room temperature sensor options based on terminal unit type and application requirement.

EZ to install

For field retrofit applications, the EZvav controller is mounted within a terminal unit controls enclosure and directly coupled to the damper shaft. The flow sensor, power supply, heat and temperature sensors are then connected. The EZvav controller automatically detects them without programming or software tools.

EZ to setup, commission and balance

All options can be set by using an STE-8001W36 sensor as a technician's service tool or installed as a permanent room sensor. The EZvav Controller can be stocked by representatives to provide a simple digital solution to their customers that wish to upgrade their pneumatic or analog inventory to a new digital solution, perfect for retrofit applications!

EZvav Digital Controllers:

Model Number Application

BAC-8001-36	Single Duct Cooling and Heat/Cool changeover
BAC-8005-36	Single Duct with Reheat and Fan Powered Applications
BAC-8007-36	Dual Duct Master
TSP-8001-36	Dual Duct Secondary Actuator

Room Temperature Sensor (Thermostat) Options:



STE-8001W36 Digital Display

- Temperature readout in deg F or C. (and time of day when networked). User Set point adjustment.
- Field Commissioning Tool.
- Password Capable.



STE-8201W36 Digital Display with Occupancy Sensor

- Same Features as STE-8001W36 with Occupancy Motion Sensor that provides unoccupied, setback and standby control.



STE-6014W36 Rotary Dial

- Small, compact and discreet.
- Economical.
- Set point Adjustable Only.

CONTROLS
F

Nailor EZvav Digital Controls (continued)

Technical Specifications:

Inputs and Outputs

All inputs and outputs for EZvav controllers are set up at the factory and do not require field programming.

Inputs

- Sensors are automatically detected.
- Inputs accept industry-standard 10K ohm thermistor sensors.
- Input over voltage protection up to 24 volts AC, continuous.
- 12-bit analog-to-digital conversion.

Triac outputs

- Optically isolated triac output.
- Maximum switching 24 volts AC at 1.0 ampere for each output.
- Maximum for controller is 3.0 amperes.

Analog outputs

- Short-circuit protected.
- Output voltage 0–10 volts DC.
- 30 mA per output, 30 mA total for all analog outputs.
- 12-bit digital-to-analog conversion.

Airflow sensor

CMOS differential pressure 0–2 inches of water (0–500 Pa) measurement range. Internally linearized and temperature compensated.

- Configured as BACnet analog input object.
- Span accuracy 4.5% of reading.
- Zero point accuracy 0.0008 in. H₂O/0.2 Pa at 77° F (25° C).
- Barbed connections for 1/4 inch FR tubing.

Actuator

Torque 40 in-lb. (4.5 N.m)

Angular Rotation 0 to 95°

Adjustable end stops at 45 and 60° rotation

Motor Timing

90 sec./90° at 60 Hz. 108 sec./90° at 50 Hz.

Shaft size

Directly mounts on 3/8 to 5/8 inch (9.5 to 16 mm) round or 3/8 to 7/16 inch (9.5 to 11 mm) square damper shafts.

BACnet communication

- Integrated peer-to-peer BACnet MS/TP network communications.
- Network speed from 9600 to 76,800 baud.
- Meets or exceeds ANSI/ASHRAE BACnet Standard 135-2008 for Application Specific Controllers.

Installation:

Supply voltage 24 volts AC (–15%, +20%),
50–60 Hz, 5 VA, Class 2 only

Weight 13.2 ounces (376 grams)

Case material Gray and black flame retardant plastic

Environmental limits

Operating 32 to 120° F (0 to 49° C)

Shipping –40 to 140° F (–40 to 60° C)

Humidity 0–95% relative humidity (non-condensing)

Regulatory

- UL 916 Energy Management Equipment.
- BACnet Testing Laboratory listed as Application Specific Controller (ASC).
- CE compliant.
- SASO PCP Registration KSA R-103263.
- FCC Class B, Part 15, Subpart B and complies with Canadian ICES-003 Class B.

Digital Controls Factory Mounting Authorization Program

Nailor Industries Terminal Units are generic in nature and compatible with all DDC controls currently available.

Nailor usually supplies and mounts its own Diamond Flow multi-point averaging flow sensor.

Controls may be factory mounted and wired by **Nailor** or field installed by the controls contractor. Nailor has a wealth of experience supplying terminal units with digital controls supplied by the Air Temperature Control (ATC) contractor, a very common requirement in today's VAV marketplace.

We have worked with all major controls companies in recent years and have developed standard factory mounting programs to ensure the highest professional, quality installation. Nailor provides custom wiring diagrams in color for each individual project.

A 24 volt Class 2 control transformer and fan relay are provided by Nailor as standard on all fan powered terminals intended for use with digital controls in order to comply with UL and ETL requirements.

Standard Control Sequences • Single Duct Terminal Units

Nailor EZvav • Pressure Independent

Control Sequence N100

Models: 3001, 3001Q and 30HQ
Cooling Only

1. As space temperature rises above the cooling setpoint, the controller increases airflow. At a space temperature of 2°F (1.1°C) above the cooling setpoint, maximum cooling airflow is maintained. On a decrease in space temperature, the controller reduces airflow. Below cooling setpoint, minimum cooling airflow is maintained.

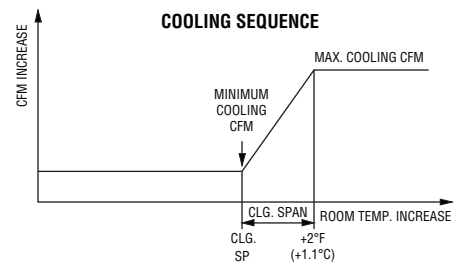

Control Sequence N101

Models: 3001, 3001Q and 30HQ
Cooling/Heating with Auto Change Over

1. Changeover/Morning Warm-up (Central AHU Heat/Cool): If supply air as measured by the discharge air temperature (DAT) sensor is below 72°F (22.2°C), cool air is said to be available. If supply air is above 76°F (24.4°C), warm air is said to be available.

2. Cool Air Available: As the space temperature rises above the cooling setpoint, the controller increases airflow. At a space temperature of 2°F (1.1°C) above the cooling setpoint, maximum cooling airflow is maintained. On a decrease in space temperature, the controller reduces airflow. Below cooling setpoint, minimum cooling airflow is maintained.

3. Warm Air Available: As the space temperature drops below the heating setpoint, the controller increases airflow. At a space temperature of 2°F (1.1°C) below the heating setpoint, maximum heating airflow is maintained. On an increase in space temperature, airflow decreases. As space temperature rises above the heating setpoint, minimum heating airflow is maintained.

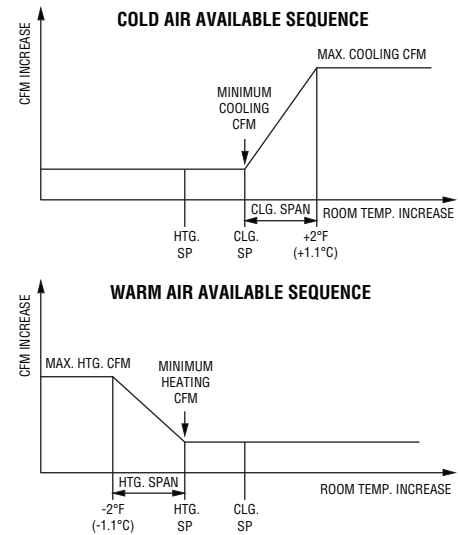

Control Sequence N102

Models: 30RE, 30REQ, 30HQE, 30RW, 30RWQ and 30HQW
Cooling with Modulating Reheat

1. Changeover/Morning Warm-up (Central AHU Heat/Cool): If supply air as measured by the discharge air temperature (DAT) sensor is below 72°F (22.2°C), cool air is said to be available. If supply air is above 76°F (24.4°C), warm air is said to be available. Any time warm air is available, auxiliary heat is locked out.

2. Cool Air Available: As the space temperature rises above the cooling setpoint, the controller increases airflow. At a space temperature of 2°F (1.1°C) above the cooling setpoint, maximum cooling airflow is maintained. On a decrease in space temperature, the controller reduces airflow. From cooling setpoint to heating setpoint, minimum cooling airflow is maintained. If the temperature drops further and reheat is required, the auxiliary flow rate is maintained.

3. Reheat: As the space temperature drops below the heating setpoint, the heating output modulates open. As the space temperature rises toward the heating setpoint, the heating output modulates closed. If the heating loop is less than 10%, the heating output remains at 0%.

4. If DAT Discharge Air Temperature limiting is enabled and a DAT sensor is detected, the discharge air reheat setpoint is determined based on the heating loop. The discharge temperature is limited to 15°F (8.3°C) above space temperature up to a maximum of 90°F (32.2°C).

5. Warm Air Available: As the space temperature drops below the heating setpoint, the controller increases airflow. At a space temperature of 2°F (1.1°C) below the heating setpoint, maximum heating airflow is maintained. On an increase in space temperature, airflow decreases. As space temperature rises above the heating setpoint, minimum heating airflow is maintained.

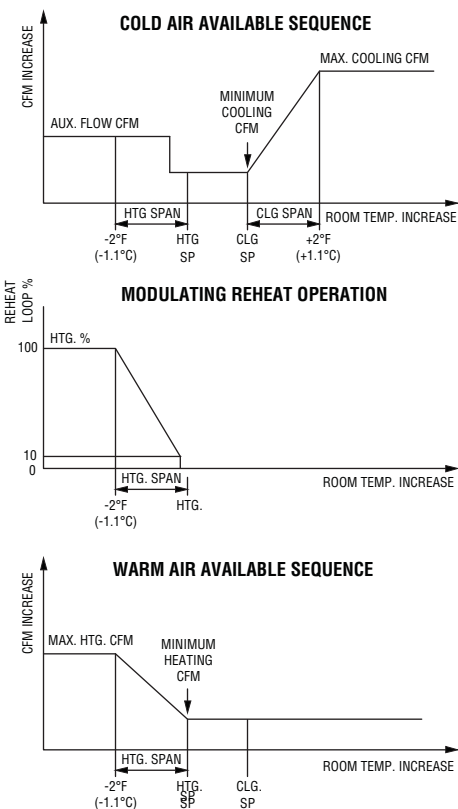

Standard Control Sequences • Single Duct Terminal Units

Nailor EZvav • Pressure Independent

Control Sequence N103

Models: 30RW, 30RWQ and 30HQW
Cooling with Floating Reheat

1. Changeover/Morning Warm-up (Central AHU Heat/Cool): If supply air as measured by the discharge air temperature (DAT) sensor is below 72°F (22.2°C), cool air is said to be available. If supply air is above 76°F (24.4°C), warm air is said to be available. Any time warm air is available, auxiliary heat is locked out.
2. Cool Air Available: As the space temperature rises above the cooling setpoint, the controller increases airflow. At a space temperature of 2°F (1.1°C) above the cooling setpoint, maximum cooling airflow is maintained. On a decrease in space temperature, the controller reduces airflow. From cooling setpoint to heating setpoint, minimum cooling airflow is maintained. If the temperature drops further and reheat is required, the auxiliary flow rate is maintained.
3. Reheat: As the space temperature drops below the heating setpoint (heating loop is greater than 70%), the valve is driven open. As the space temperature rises back toward the heating setpoint, (heating loop is less than 30%), the valve is driven closed. If the loop is in between, there is no valve action.
4. If DAT Discharge Air Temperature limiting is enabled and a DAT sensor is detected, the discharge air reheat setpoint is determined based on the heating loop. The discharge temperature is limited to 15°F (8.3°C) above space temperature up to a maximum of 90°F (32.2°C).
5. Warm Air Available: As the space temperature drops below the heating setpoint, the controller increases airflow. At a space temperature of 2°F (1.1°C) below the heating setpoint, maximum heating airflow is maintained. On an increase in space temperature, airflow decreases. As space temperature rises above the heating setpoint, minimum heating airflow is maintained.

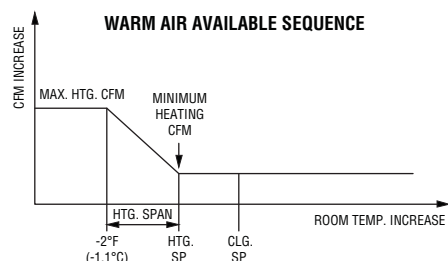
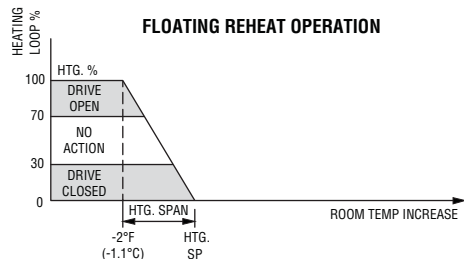
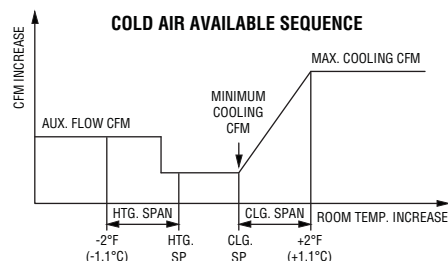

Control Sequence N104

Models: 30RE, 30REQ and 30HQE, 30RW, 30RWQ and 30HQW
Cooling with Binary Reheat (Staged Electric On/Off Hot Water)

1. Changeover/Morning Warm-up (Central AHU Heat/Cool): If supply air as measured by the discharge air temperature (DAT) sensor is below 72°F (22.2°C), cool air is said to be available. If supply air is above 76°F (24.4°C), warm air is said to be available. Any time warm air is available, auxiliary heat is locked out.
 2. Cool Air Available: As the space temperature rises above the cooling setpoint, the controller increases airflow. At a space temperature of 2°F (1.1°C) above the cooling setpoint, maximum cooling airflow is maintained. On a decrease in space temperature, the controller reduces airflow. From cooling setpoint to heating setpoint, minimum cooling airflow is maintained. If the temperature drops further and reheat is required, the auxiliary flow rate is maintained.
 3. Reheat: As the space temperature drops below the heating setpoint, up to 3 stages of electric reheat are energized respectively. As the space temperature rises back toward the heating setpoint, heating stages 3, 2 and 1 turn off respectively (Alternatively, an on/off two position spring return hot water valve can be controlled).
 4. Warm Air Available: As the space temperature drops below the heating setpoint, the controller increases airflow. At a space temperature of 2°F (1.1°C) below the heating setpoint, maximum heating airflow is maintained. On an increase in space temperature, airflow decreases. As space temperature rises above the heating setpoint, minimum heating airflow is maintained.
- Note: **DO NOT** enable the DAT Discharge Air Temperature limiting feature for binary staged or on/off reheat as short cycling will occur.

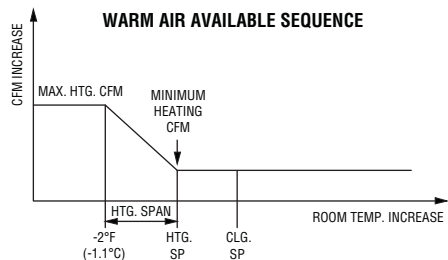
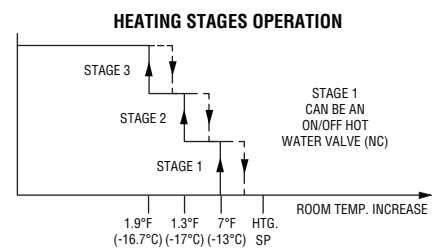
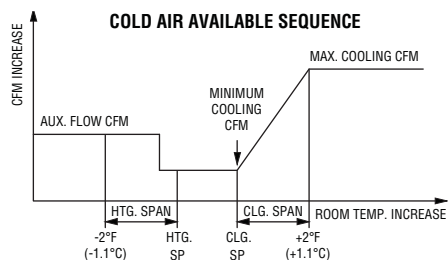

Standard Control Sequences • Single Duct Terminal Units

Nailor EZvav • Pressure Independent

Control Sequence N110

Models: 3001, 3001Q and 30HQ
Cooling Only, Constant Volume

1. Airflow setpoint is maintained.

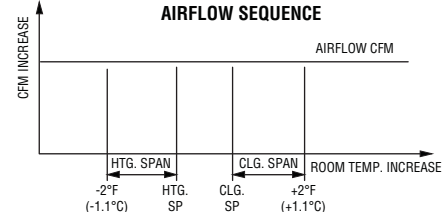

Standard Control Sequences • Dual Duct Terminal Units

Nailor EZvav • Pressure Independent

Control Sequence N200

Models: 3230 and 3240
Variable Volume

1. As the space temperature rises above the cooling setpoint, the primary airflow is modulated from the cooling minimum flow to the cooling maximum flow.
2. As the space temperature falls below the heating setpoint, the secondary airflow is modulated from the heating minimum flow to the heating maximum flow.
3. Between the heating and cooling setpoints, both the primary airflow and secondary airflow are modulated to maintain the dual mixing minimum.

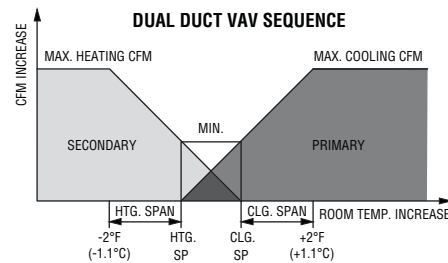

Control Sequence N201

Models: 3230 and 3240
Constant Volume

1. As the space temperature rises above the cooling setpoint, the primary airflow is modulated from the cooling minimum flow to the cooling maximum flow.
2. As the space temperature falls below the heating setpoint, the secondary airflow is modulated from the heating minimum flow to the heating maximum flow.
3. Between the heating and cooling setpoints, both the primary airflow and secondary airflow are modulated to maintain the dual mixing minimum.

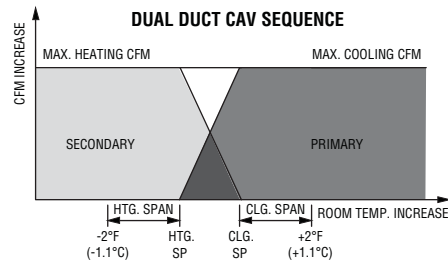

Standard Control Sequences • Fan Powered Terminal Units • Series Flow

Nailor EZvav • Pressure Independent

Control Sequence N300

Models: 35S, 35SST, 37S and 37SST

Cooling (Plenum Heat Only), Constant Volume

1. Changeover/Morning Warm-up (Central AHU Heat/Cool): If supply air as measured by the discharge air temperature (DAT) sensor is below 72°F (22.2°C), cool air is said to be available. If supply air is above 76°F (24.4°C), warm air is said to be available.

2. Cool Air Available: As space temperature rises above the cooling setpoint, the controller increases primary airflow. At a space temperature of 2°F (1.1°C) above the cooling setpoint, maximum cooling airflow is maintained. On a decrease in space temperature, the controller reduces airflow. Below cooling setpoint, minimum airflow is maintained.

3. The fan is started during occupied and standby modes and runs continuously at maximum fan speed. The fan induces warm ceiling plenum air as the primary airflow varies and maintains a constant volume to the space. During unoccupied mode, the fan starts on a call for heat only. The fan stops only during unoccupied mode when there is no call for heat. EPIC ECM Motor Only: During standby and unoccupied modes, the fan runs at minimum fan speed.

4. As the space temperature drops below the heating setpoint, the fan continues to recirculate warm ceiling plenum air.

5. Warm Air Available: As space temperature drops below the heating setpoint, the controller increases primary airflow. At a space temperature of 2°F (1.1°C) below the heating setpoint, maximum heating airflow is maintained. On an increase in space temperature, airflow decreases. As space temperature rises above the heating setpoint, minimum heating airflow is maintained.

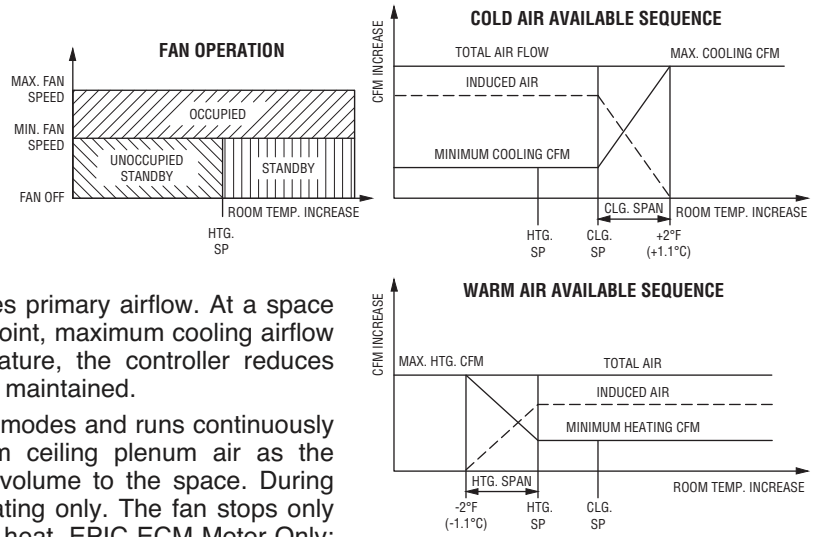

Control Sequence N302

Models: 35SE, 35SEST, 35SW, 35SWST, 37SE, 37SEST, 37SW and 37SWST

Cooling with Modulating Heat, Constant Volume

1. Changeover/Morning Warm-up (Central AHU Heat/Cool): If supply air as measured by the discharge air temperature (DAT) sensor is below 72°F (22.2°C), cool air is said to be available. If supply air is above 76°F (24.4°C), warm air is said to be available. Any time warm air is available, auxiliary heat is locked out.

2. Cool Air Available: As space temperature rises above the cooling setpoint, the controller increases primary airflow. At a space temperature of 2°F (1.1°C) above the cooling setpoint, maximum cooling airflow is maintained. On a decrease in space temperature, the controller reduces airflow. Below cooling setpoint, minimum airflow is maintained.

3. The fan is started during occupied and standby modes and runs continuously at maximum fan speed. The fan induces warm ceiling plenum air as the primary airflow varies and maintains a constant volume to the space. During unoccupied mode, the fan starts on a call for heating only. The fan stops only during unoccupied mode when there is no call for heat. EPIC ECM Motor Only: During standby and unoccupied modes, the fan runs at minimum fan speed.

4. Supplemental Heat: As the space temperature drops below the heating setpoint, the heating output modulates open. As the space temperature rises towards the heating setpoint, the heating modulates closed. If the heating loop is less than 10%, the heating output remains at 0%.

5. If DAT limiting is enabled and a DAT sensor is detected, the discharge air heating setpoint is determined based on the heating loop. The discharge temperature is limited to 15°F (8.3°C) above space temperature up to a maximum of 90°F (32.2°C).

6. Warm Air Available: As space temperature drops below the heating setpoint, the controller increases primary airflow. At a space temperature of 2°F (1.1°C) below the heating setpoint, maximum heating airflow is maintained. On an increase in space temperature, airflow decreases. As space temperature rises above the heating setpoint, minimum heating airflow is maintained.

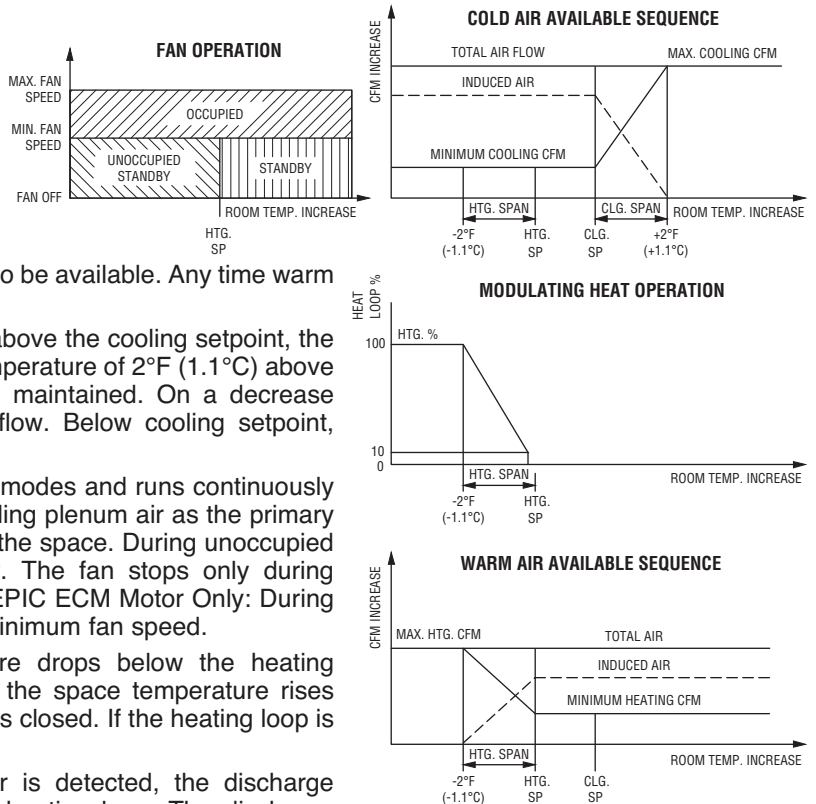

Standard Control Sequences • Fan Powered Terminal Units • Series Flow

Nailor EZvav • Pressure Independent

Control Sequence N303

Models: 35SE, 35SEST, 35SW, 35SWST, 37SE, 37SEST, 37SW and 37SWST

Cooling with Floating Heat, Constant Volume

1. Changeover/Morning Warm-up (Central AHU Heat/Cool): If supply air as measured by the discharge air temperature (DAT) sensor is below 72°F (22.2°C), cool air is said to be available. If supply air is above 76°F (24.4°C), warm air is said to be available. Any time warm air is available, auxiliary heat is locked out.

2. Cool Air Available: As space temperature rises above the cooling setpoint, the controller increases primary airflow. At a space temperature of 2°F (1.1°C) above the cooling setpoint, maximum cooling airflow is maintained. On a decrease in space temperature, the controller reduces airflow. Below cooling setpoint, minimum airflow is maintained.

3. The fan is started during occupied and standby modes and runs continuously at maximum fan speed. The fan induces warm ceiling plenum air as the primary airflow varies and maintains a constant volume to the space. During unoccupied mode, the fan starts on a call for heating only. The fan stops only during unoccupied mode when there is no call for heat. EPIC ECM Motor Only: During standby and unoccupied modes, the fan runs at minimum fan speed.

4. Supplemental Heat: As the space temperature drops below the heating setpoint (heating loop is greater than 70%), the valve is driven open. As the space temperature rises back toward the heating setpoint (heating loop is less than 30%), the valve is driven closed. If the loop is in between, there is no valve action.

5. If DAT limiting is enabled and a DAT sensor is detected, the discharge air heating setpoint is determined based on the heating loop. The discharge temperature is limited to 15°F (8.3°C) above space temperature up to a maximum of 90°F (32.2°C).

6. Warm Air Available: As space temperature drops below the heating setpoint, the controller increases primary airflow. At a space temperature of 2°F (1.1°C) below the heating setpoint, maximum heating airflow is maintained. On an increase in space temperature, airflow decreases. As space temperature rises above the heating setpoint, minimum heating airflow is maintained.

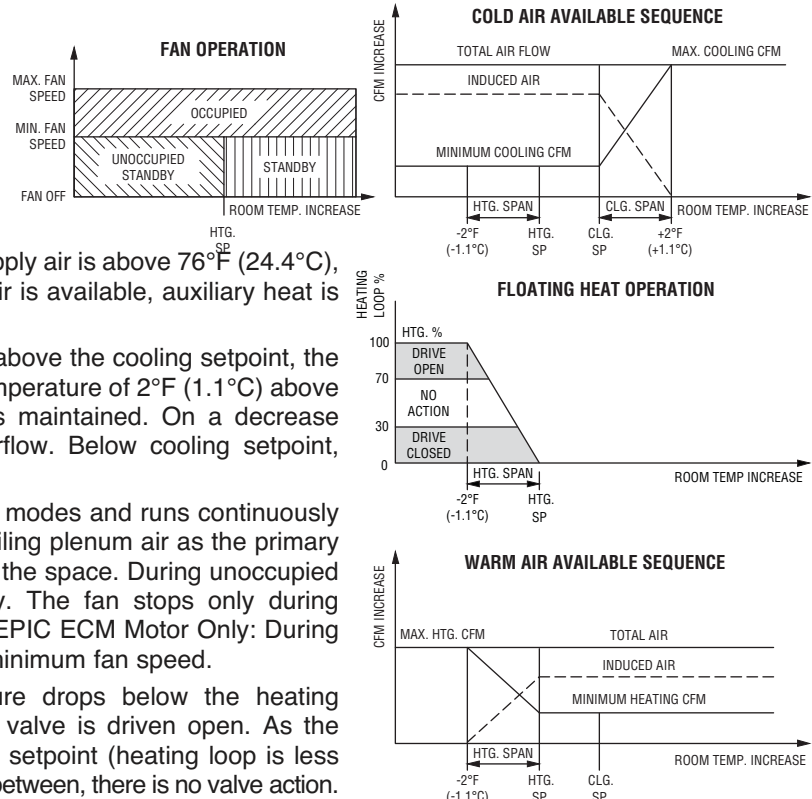

CONTROLS

F

Standard Control Sequences • Fan Powered Terminal Units • Series Flow

Nailor EZvav • Pressure Independent

Control Sequence N304

Models: 35SE, 35SEST, 35SW, 35SWST, 37SE, 37SEST, 37SW and 37SWST

Cooling with Binary Heat (Staged Electric or On/Off Hot Water)

1. Changeover/Morning Warm-up (Central AHU Heat/Cool): If supply air as measured by the discharge air temperature (DAT) sensor is below 72°F (22.2°C), cool air is said to be available. If supply air is above 76°F (24.4°C), warm air is said to be available. Any time warm air is available, auxiliary heat is locked out.

2. Cool Air Available: As space temperature rises above the cooling setpoint, the controller increases primary airflow. At a space temperature of 2°F (1.1°C) above the cooling setpoint, maximum cooling airflow is maintained. On a decrease in space temperature, the controller reduces airflow. Below cooling setpoint, minimum airflow is maintained.

3. The fan is started during occupied and standby modes and runs continuously at maximum fan speed. The fan induces warm ceiling plenum air as the primary airflow varies and maintains a constant volume to the space. During unoccupied mode, the fan starts on a call for heating only. The fan stops only during unoccupied mode when there is no call for heat. EPIC ECM Motor Only: During standby and unoccupied modes, the fan runs at minimum fan speed.

4. Supplemental Heat: As the space temperature drops below the heating setpoint, up to 3 stages of electric heat are energized respectively. As the space temperature rises back toward the heating setpoint, heating stages 3, 2 and 1 turn off respectively (Alternatively, an on/off two position spring return hot water valve can be controlled).

5. Warm Air Available: At a space temperature of 2°F (1.1°C) below the heating setpoint, maximum heating airflow is maintained. On an increase in space temperature, airflow decreases. As space temperature rises above the heating setpoint, minimum heating airflow is maintained.

Note: **DO NOT** enable the DAT Discharge Air Temperature limiting feature for binary staged or on/off reheat as short cycling will occur.

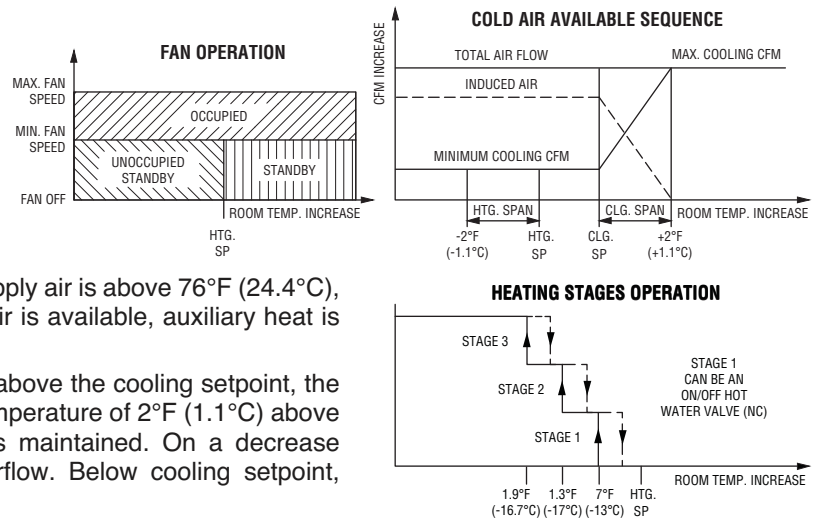

Standard Control Sequences • Fan Powered Terminal Units • Parallel Flow

Nailor EZvav • Pressure Independent

Control Sequence N400

Models: 35N and 37N

Cooling (Plenum Heat Only)

1. Changeover/Morning Warm-up (Central AHU Heat/Cool): If supply air as measured by the discharge air temperature (DAT) sensor is below 72°F (22.2°C), cool air is said to be available.

2. Cool Air Available: As space temperature rises above the cooling setpoint, the controller increases primary airflow. At a space temperature of 2°F (1.1°C) above the cooling setpoint, maximum cooling airflow is maintained. On a decrease in space temperature, the controller reduces airflow. Below cooling setpoint, minimum airflow is maintained.

3. The fan is started only on a call for heat. The fan stops if there is no call for heat. The fan induces warm ceiling plenum air. During occupied mode, the fan runs at maximum fan speed. EPIC ECM Motor Only: During standby and unoccupied modes, the fan runs at minimum fan speed.

4. As the space temperature drops below the heating setpoint, the fan continues to recirculate warm ceiling plenum air.

5. Warm Air Available: The fan is locked out. As space temperature drops below the heating setpoint, the controller increases primary airflow. At a space temperature of 2°F (1.1°C) below the heating setpoint, maximum heating airflow is maintained. On an increase in space temperature, airflow decreases. As space temperature rises above the heating setpoint, minimum heating airflow is maintained.

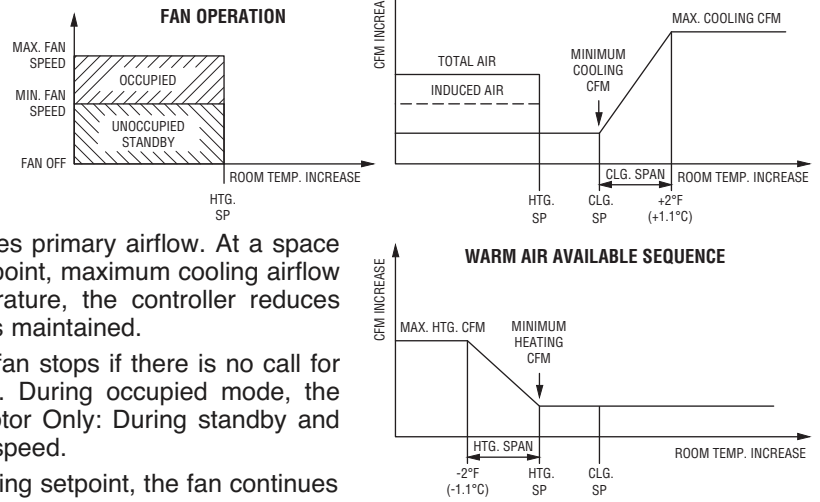

Control Sequence N402

Models: 35NE, 35NW, 37NE and 37NW

Cooling with Modulating Heat

1. Changeover/Morning Warm-up (Central AHU Heat/Cool): If supply air as measured by the discharge air temperature (DAT) sensor is below 72°F (22.2°C), cool air is said to be available. If supply air is above 76°F (24.4°C), warm air is said to be available. Any time warm air is available, auxiliary heat is locked out.

2. Cool Air Available: As space temperature rises above the cooling setpoint, the controller increases primary airflow. At a space temperature of 2°F (1.1°C) above the cooling setpoint, maximum cooling airflow is maintained. On a decrease in space temperature, the controller reduces airflow. Below cooling setpoint, minimum airflow is maintained.

3. The fan is started only on a call for heat. The fan stops if there is no call for heat. The fan induces warm ceiling plenum air. During occupied mode, the fan runs at maximum fan speed. EPIC ECM Motor Only: During standby and unoccupied modes, the fan runs at minimum fan speed.

4. Supplemental Heat: As the space temperature drops below the heating setpoint, the heating output modulates open. As the space temperature rises towards the heating setpoint, the heating modulates closed. If the heating loop is less than 10%, the heating output remains at 0%.

5. If DAT limiting is enabled and a DAT sensor is detected, the discharge air heating setpoint is determined based on the heating loop. The discharge temperature is limited to 15°F (8.3°C) above space temperature up to a maximum of 90°F (32.2°C).

6. Warm Air Available: The fan is locked out. As space temperature drops below the heating setpoint, the controller increases primary airflow. At a space temperature of 2°F (1.1°C) below the heating setpoint, maximum heating airflow is maintained. On an increase in space temperature, airflow decreases. As space temperature rises above the heating setpoint, minimum heating airflow is maintained.

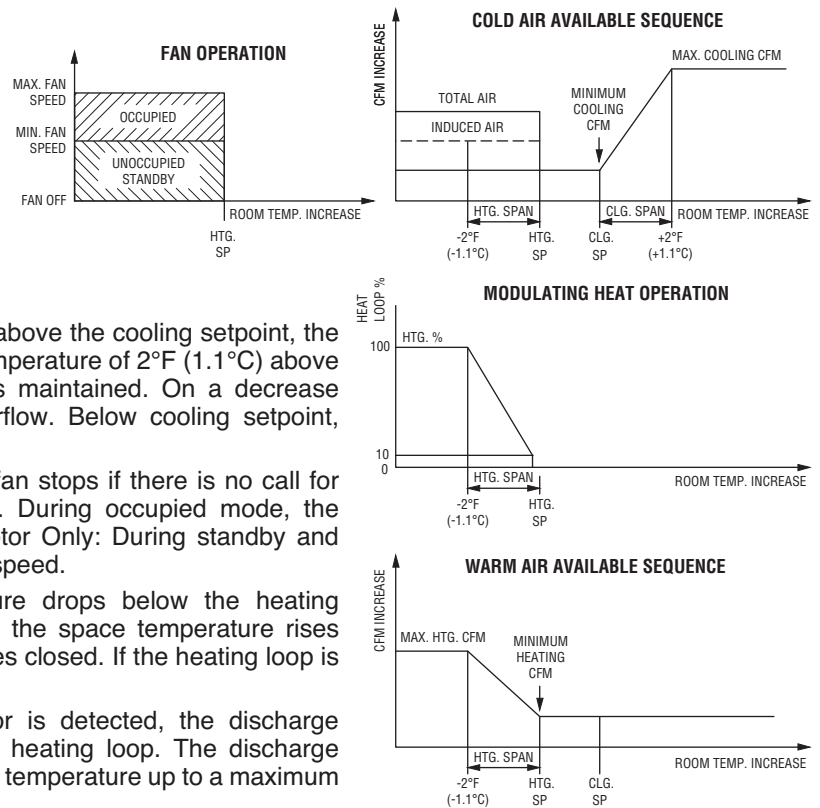

Standard Control Sequences • Fan Powered Terminal Units • Parallel Flow Nailor EZvav • Pressure Independent

Control Sequence N403

Models: 35NW and 37NW

Cooling with Floating Heat

- Changeover/Morning Warm-up (Central AHU Heat/Cool):** If supply air as measured by the discharge air temperature (DAT) sensor is below 72°F (22.2°C), cool air is said to be available. If supply air is above 76°F (24.4°C), warm air is said to be available. Any time warm air is available, auxiliary heat is locked out.
- Cool Air Available:** As space temperature rises above the cooling setpoint, the controller increases primary airflow. At a space temperature of 2°F (1.1°C) above the cooling setpoint, maximum cooling airflow is maintained. On a decrease in space temperature, the controller reduces airflow. Below cooling setpoint, minimum airflow is maintained.
- The fan is started during occupied and standby modes and runs continuously at maximum fan speed.** The fan induces warm ceiling plenum air as the primary airflow varies and maintains a constant volume to the space. During unoccupied mode, the fan starts on a call for heating only. The fan stops only during unoccupied mode when there is no call for heat. EPIC ECM Motor Only: During standby and unoccupied modes, the fan runs at minimum fan speed.
- Supplemental Heat:** As the space temperature drops below the heating setpoint (heating loop is greater than 70%), the valve is driven open. As the space temperature rises back toward the heating setpoint (heating loop is less than 30%), the valve is driven closed. If the loop is in between, there is no valve action.
- If DAT limiting is enabled and a DAT sensor is detected,** the discharge air heating setpoint is determined based on the heating loop. The discharge temperature is limited to 15°F (8.3°C) above space temperature up to a maximum of 90°F (32.2°C).
- Warm Air Available:** As space temperature drops below the heating setpoint, the controller increases primary airflow. At a space temperature of 2°F (1.1°C) below the heating setpoint, maximum heating airflow is maintained. On an increase in space temperature, airflow decreases. As space temperature rises above the heating setpoint, minimum heating airflow is maintained.

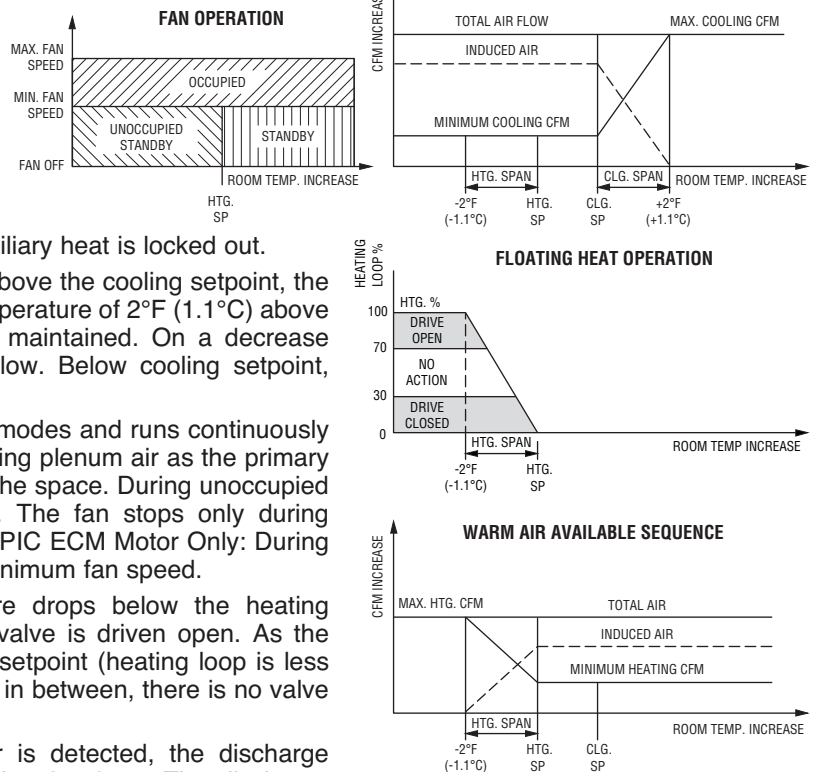

Standard Control Sequences • Fan Powered Terminal Units • Parallel Flow

Nailor EZvav • Pressure Independent

Control Sequence N404

Models: 35NE, 35NW, 37NE and 37NW

**Cooling with Binary Heat
(Staged Electric or On/Off Hot Water)**

1. Changeover/Morning Warm-up (Central AHU Heat/Cool): If supply air as measured by the discharge air temperature (DAT) sensor is below 72°F (22.2°C), cool air is said to be available. If

supply air is above 76°F (24.4°C), warm air is said to be available. Any time warm air is available, auxiliary heat is locked out.

2. Cool Air Available: As space temperature rises above the cooling setpoint, the controller increases airflow. At a space temperature of 2°F (1.1°C) above the cooling setpoint, maximum cooling airflow is maintained. On a decrease in space temperature, the controller reduces airflow. Below cooling setpoint minimum airflow is maintained.

3. The fan is started only on a call for heat. The fan stops if there is no call for heat. During occupied mode, the fan runs at maximum fan speed. EPIC ECM Motor Only: During standby and unoccupied modes, the fan runs at minimum fan speed.

4. Supplemental Heat: As the space temperature drops below the heating setpoint, up to 3 stages of electric heat are energized respectively. As the space temperature rises back toward the heating setpoint, heating stages 3, 2 and 1 turn off respectively (Alternatively, an on/off two position spring return hot water valve can be controlled).

5. Warm Air Available: The fan is locked out. As space temperature drops below the heating setpoint, maximum heating airflow is maintained. On an increase in space temperature, airflow decreases. As space temperature rises above the heating setpoint, minimum heating airflow is maintained.

Note: **DO NOT** enable the DAT Discharge Air Temperature limiting feature for binary staged or on/off reheat as short cycling will occur.

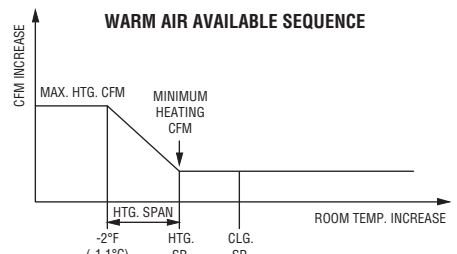
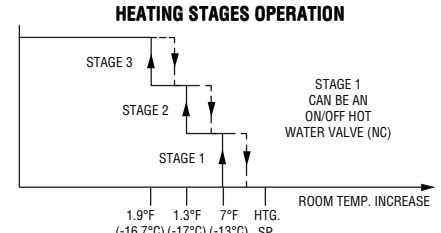
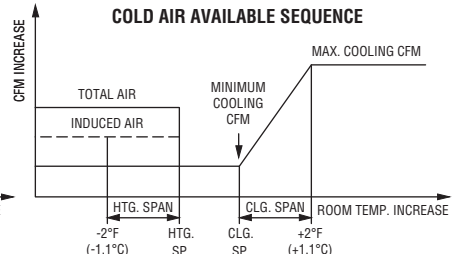
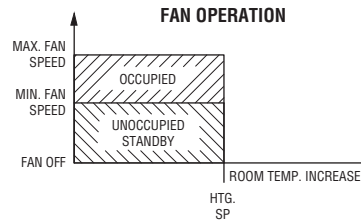

CONTROLS

F

Analog Electronic Controls

Pressure Dependent Control

Micro-processor based technology has resulted in the widespread development and use of pressure independent controls for terminal units and the demise of pressure dependent controls. Although more expensive, they generally provide superior room temperature control of the occupied space and improved occupant comfort. Pressure dependent controls are still used however on some light commercial projects with constant volume packaged air handlers. A popular use still is on Bypass terminal units which are an inherently pressure dependent design. The following components are used in pressure dependent control applications.

Tri-State Floating Actuators

These 3-wire 24 VAC reversible actuators are available in various cycle time models to suit the application. All models feature direct drive mounting and built in adjustable mechanical end stops which limit damper rotation and provide a minimum position air volume capability. A manual clutch release speeds installation. A magnetic coupling provides stall torque protection.

KMC Controls, 40 in. – lb., 95° rotation.

MEP-4003: 60°/min. (1 1/2 minutes 90°)

MEP-5061: 18°/min. (5 minutes 90°)

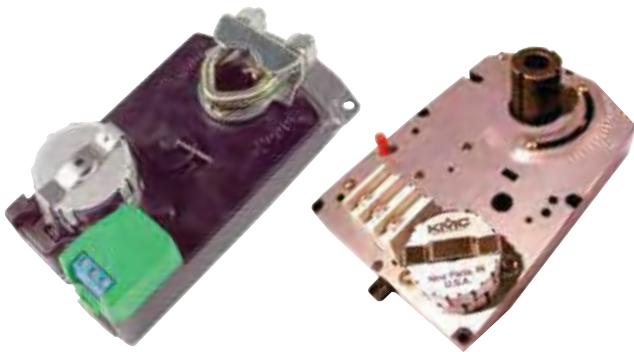

Model MEP-4003 and 5061

VT7200 Series Room Thermostat

Advanced micro-computer electronics and PI control algorithms provide precise temperature control. The thermostat provides a true multi-position modulating output to a tri-state floating actuator. This eliminates wasted energy caused by typical on-off cycling with conventional thermostats resulting in significant energy savings and superior comfort. Control accuracy is $\pm 0.4^\circ\text{F}$ ($\pm 0.2^\circ\text{C}$) around set point. The room occupant is able to reduce the set point to the lowest comfortable setting. A mechanical air volume minimum stop is provided (field set) on the damper actuator.



Model VT7200C5000

Pressure Independent Control

The analog electronic controls provide pressure independent control. The components are matched and calibrated and provide regulated airflow in response to the electronic room thermostat, which is furnished as a part of the control package. Minimum and maximum airflow settings are adjusted at the thermostat. It is not necessary to adjust flow setting at the terminal in the ceiling space.

The Nailor analog electronic controls utilize the Diamond Flow multi-point averaging sensor as standard for accurate flow measurement.

The electronic thermostat has a fixed 2°F proportional band regardless of minimum or maximum velocity set points and provides a linear reset function. The electronic controller/actuator features an on-board flow transducer.

Electric actuators are not spring return devices (there is no normally open or normally closed action). If there is a loss of power to the terminal, the damper will remain in the position it was in at the time of power failure. All electric components use low voltage (24 volt) controls. A step down transformer is provided as standard.

Control Features:

- Proportional plus integral control function provides precise flow and temperature control.
- Stand alone operation.
- Simple installation and balancing.
- Reliable operation and excellent repeatability (settings do not drift with time).
- Less costly than digital controls with no programming requirement.
- Suitable for small to medium building applications where networking is not required.
- Flexibility built-in to handle all control applications.

Nailor is pleased to make available on improved range of pressure independent analog electronic controls for terminal units. These controls now incorporate the Diamond Flow multi-point averaging sensor for accurate flow measurement as standard, a re-designed higher torque controller/actuator and a new digital display room thermostat design.

Analog Electronic Controls (continued)

Controller/Actuator Features

- Compact combination design eliminates separate circuit boards.
- Onboard dead end transducer.
- Direct drive 24 VAC tri-state damper actuator @ 40 in. - lb. (4.5 Nm) torque.
- Magnetic clutch and gear disengagement button.
- LED light indicate damper opening and closing.
- Available control options include proportional (0–10 VDC) or two position hot water or electric reheat control, dual minimum airflow settings, dual duct and fan powered applications.



Model CSP-4702 Analog Controller/Actuator

Legacy Model Thermostat Features:

- Single function models with single set point slider for cooling only or heating only applications.
- Dual function models with two set point sliders for cooling/heating applications.
- Bi-metallic thermometer and set point indicator.
- Live velocity readout.
- Minimum, maximum and auxiliary flow limit adjustments.
- Attractive modern design.
- Fahrenheit or Celsius scale plate option.
- Set point sliders hidden on underside of tamper-proof cover.
- Mounting choice – decorative backing plate for electrical box attachment or drywall mounting kit.



CTE-5100 Analog Thermostat

New LCD Display Thermostat Features:

(Available Summer 2017. Contact factory for availability)

- Large LCD display for easy viewing (or can be blanked if desired) and configuration.
- Display room temperature in either degrees Fahrenheit or Celsius.
- Easy setpoint adjustment via front Up and Down buttons.
- Heating and cooling setpoints with three selectable sequences.
- Outputs configurable to conventional spans between 0 and 12 VDC.
- Adjustable min./max./aux. limits (span), dead-band, proportional band, integral, temperature offset, setback offset, and changeover.
- External input for changeover sensor, morning warm-up, and setback contact.



New Model CTE-5202 LCD Display Analog Thermostat

Diamond Flow Sensor

All components are matched and calibrated to provide regulated airflow in response to the electronic room thermostat, which is furnished as an integral part of the control package. Analog controls are configured and airflow settings are entered at the thermostat using the large LCD digital display. The menu is intuitive and easy to use for full calibration. It is not necessary to enter the ceiling space and locate the terminal itself for field calibration thereby reducing time and disruption.



Nailor Diamond Flow Sensor

Standard Control Sequences • Single Duct Terminal Units

Analog Electronic • Pressure Independent

Control Sequence 1 EL

Cooling Only

The operating sequence for a cooling application is as follows:

1. On a rise in space temperature, the thermostat regulates the controller/actuator to increase the airflow. At 2°F (1.1°C) above thermostat set point, the maximum airflow is maintained at a preselected setting.
2. On a decrease in space temperature, the thermostat regulates the controller/actuator to reduce airflow. At thermostat set point, the minimum airflow is maintained at a preselected setting.
3. Airflow is held constant in accordance with thermostat demand. Any changes in duct air velocity due to static pressure fluctuations are sensed and compensated for, resulting in pressure independent control.

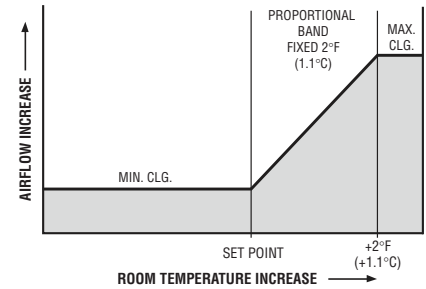

Control Sequence 3 EL

Cooling/Heating with Auto – Changeover

The heating/cooling thermostat features separate temperature set points and separate min./max. velocity limits for heating and cooling operation. The automatic changeover relay energizes either the heating or cooling mode of the thermostat in response to the duct temperature. The operating sequence is as follows:

1. At a duct temperature above 77°F (25°C), the heating side of the thermostat is energized.
2. On a decrease in space temperature, the thermostat regulates the controller/actuator to increase the airflow. At 2°F (1.1°C) below thermostat heating set point, the maximum airflow is maintained at a preselected setting on a rise in space temperature, the thermostat regulates the controller/actuator to decrease the airflow. At a space temperature above thermostat heating set point, the minimum airflow is maintained at a preselected setting.
3. At a duct temperature below 77°F (25°C), the cooling side of the thermostat is energized.
4. On a rise in space temperature, the thermostat regulates the controller/actuator to increase the airflow. At 2°F (1.1°C) above thermostat cooling set point, the maximum airflow is maintained at a preselected setting. On a decrease in space temperature, the thermostat regulates the controller/actuator to reduce the airflow. At thermostat cooling set point, the minimum airflow is maintained at a preselected setting.
5. During both the heating and cooling cycle, airflow is held constant in accordance with thermostat demand. Any changes in duct air velocity due to static pressure fluctuations are sensed and compensated for, resulting in pressure independent control.

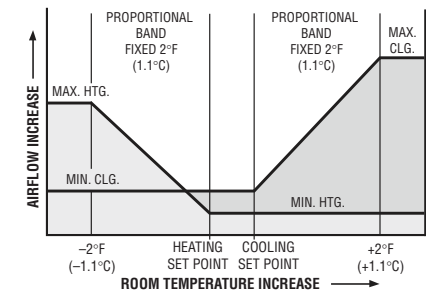

Control Sequence 4 EL

Cooling with Morning Warm-Up

The operating sequence is as follows:

1. On a rise in space temperature, the thermostat regulates the controller/actuator to increase the airflow. At 2°F (1.1°C) above thermostat set point, the maximum airflow is maintained at a preselected setting.
2. On a decrease in space temperature, the thermostat regulates the controller/actuator to reduce airflow. At thermostat set point, the minimum airflow is maintained at a preselected setting.
3. Airflow is held constant in accordance with thermostat demand. Any changes in duct air velocity due to static pressure fluctuations are sensed and compensated for, resulting in pressure independent control.
4. When duct airflow temperature is above 77°F (25°C) (warm-up cycle), the inlet sensor switches a relay module and the actuator will drive the damper fully open for unrestricted maximum airflow.

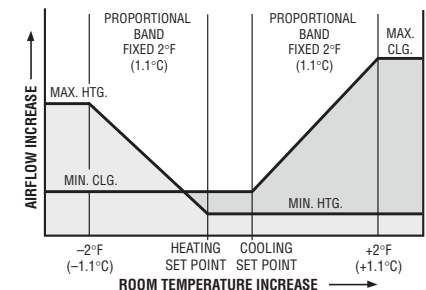

Standard Control Sequences • Single Duct Terminal Units

Analog Electronic • Pressure Independent

Control Sequence 5 EL

Cooling with Electric Reheat and Auxiliary Minimum Flow

The reheat thermostat features a separate temperature set point and a separate auxiliary flow limit for reheat control. The reheat relay energizes up to three stages of electric reheat in response to the thermostat. The operating sequence for a reheat application is as follows:

1. On a rise in space temperature, the thermostat regulates the controller/actuator to increase the airflow. At 2°F (1.1°C) above thermostat set point, the maximum airflow is maintained at a preselected setting.
2. On a decrease in space temperature, the thermostat regulates the controller/actuator to reduce the airflow. At thermostat set point, the minimum airflow is maintained at a preselected setting.
3. On a further decrease in space temperature the heating side of the thermostat is activated, automatically initiating the auxiliary flow limit. Airflow is maintained at the preselected auxiliary setting.
4. Up to three stages of reheat are energized in sequence in response to the thermostat. The first stage is energized 0.7°F (0.4°C) below the heating set point. The optional second and third stage are energized at 1.3°F and 1.9°F (0.7°C and 1.1°C) below heating, respectively.
5. Airflow is held constant in accordance with thermostat demand. Any changes in duct air velocity due to static pressure fluctuations are sensed and compensated for, resulting in pressure independent control.

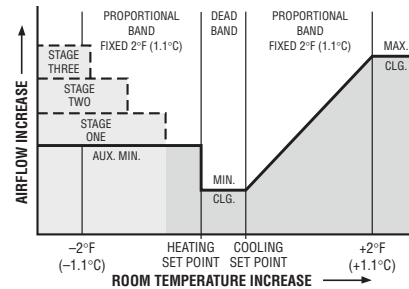

Control Sequence 8 EL

Cooling with Proportional Hot Water Reheat and Auxiliary Minimum Flow

The cooling/reheat thermostat features separate temperature set points and an auxiliary flow limit for desired airflow across the reheat coil. Airflow is held constant in accordance with thermostat demand. Any changes in duct air velocity due to static pressure fluctuations are sensed and compensated for, resulting in pressure independent control.

The sequence of operation is as follows:

1. As the room temperature increases, the room thermostat modulates the cold airflow from the minimum to the maximum setting. At 2°F (1.1°C) above cooling set point, maximum airflow is maintained. On a decrease in room temperature, the damper modulates to the minimum position.
2. On a decrease in room temperature below heating set point, the heating side of the thermostat is activated, automatically indexing the auxiliary minimum setting and the proportional hot water reheat valve (0 – 10 Vdc, by others) begins to modulate open.
3. At a room temperature of 2°F (1.1°C) below the thermostat heating set point, the hot water valve is fully open.
4. On an increase in room temperature, the reverse sequence occurs.

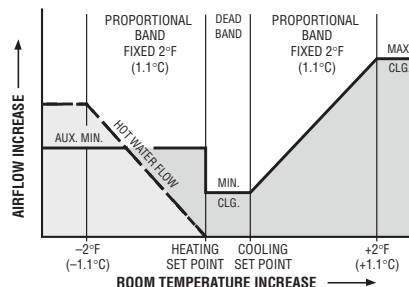

The following additional control sequences are also available

(Contact your Nailor representative for further information):

- 6 EL • Cooling With Electric Reheat Plus Morning Warm-up.
- 7 EL • Cooling With On/Off Hot Water Reheat and Auxiliary Minimum Flow (24 VAC N.C. valve, by others).
- 9 EL • Cooling With On/Off Auxiliary Heat (Perimeter Radiation).
- 10 EL • Constant Volume Operation.

Standard Control Sequences • Dual Duct Terminal Units

Analog Electronic • Pressure Independent

The typical control diagrams shown on this page are based on our standard **CSP 5000 Series** or **CSP 4000 Series** electronic controller/actuator. They feature the adjustment of minimum and maximum flow set points at the room thermostat, rather than at the box controller. The electronic room thermostat has a dual set point for heating and cooling.

Control Sequence DE1 (CSP 5000) • Model 3210

- Variable Volume – Hot and Cold Airflow without Mixing and Zero Minimum

- Hot and Cold Deck Inlet Sensing

The hot and cold decks are set for equal or unequal maximum air volumes each with a minimum setting of zero.

At full cooling demand, the hot deck valve is closed and the cold deck valve is at maximum cooling. On a drop in room temperature, the cold deck modulates down to zero in response to thermostat demand. On a further drop in room temperature, the hot deck begins to open and airflow increases from zero to its maximum setting.

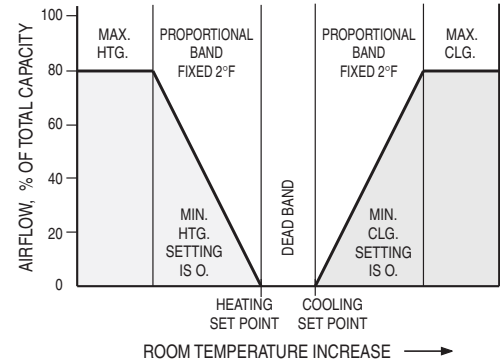

Control Sequence DE2 (CSP 5000) • Model 3230 or 3240

- Variable Volume – Hot and Cold Airflow with Limited Mixing
- Hot and Cold Deck Inlet Sensing
- Minimum Air From Cold Deck

The hot and cold decks are set for equal or unequal maximum air volumes. The hot deck has a minimum setting of zero. The minimum air is from the cold deck.

At full cooling demand, the hot deck valve is closed and the cold deck valve is at maximum cooling. On a drop in room temperature, the cold deck modulates down to the minimum setting (or zero) in response to thermostat demand. On a further drop in room temperature, the hot deck volume increases from zero to its maximum setting and the cold deck goes to zero.

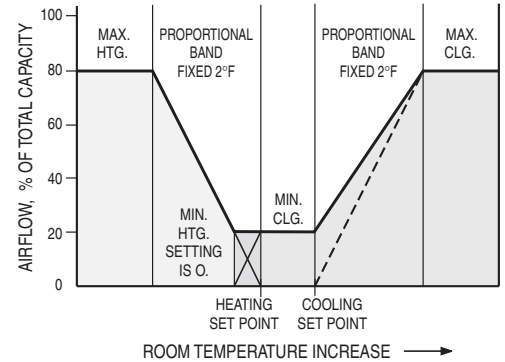

Control Sequence DE3 (CSP 4000) • Model 3230 or 3240

- Constant Volume – Hot Deck Make-Up
- Total Air Sensing In Common Discharge (Hot Deck Make-up)

The cold deck is set for calibrated minimum and maximum airflows required from the cold deck. The hot deck controller, with its sensor located in the common discharge, is set for the required constant volume, which must be equal to, or greater than the cold deck maximum flow.

At full cooling demand, the cold deck valve is at maximum cooling and the hot deck valve is closed. On a drop in room temperature, the cold deck volume reduces to its minimum setting. As the cold deck volume reduces, the hot deck valve adds the additional air required to maintain the constant volume setting.

(This sequence is also available using the CSP 5000 Series controller actuator, except that hot and cold deck inlet sensing is utilized. Control Sequence DE4).

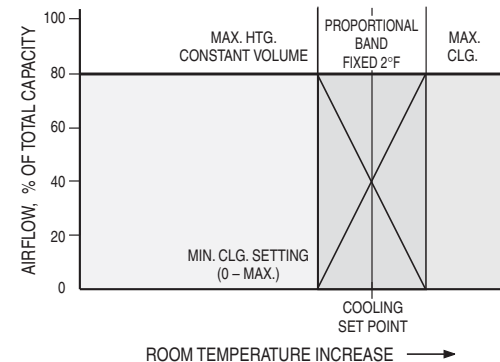

Standard Control Sequences • Fan Powered Terminal Units • Series Flow

Model Series 35S, 35SST, 37S and 37SST

Analog Electronic Sequences

Description	Code
Cooling (continuous operation)	A1
Cooling w/morning warm-up (continuous operation)	A2
Cooling w/staged electric, auxiliary or on-off hot water heat (continuous operation)	A3
Cooling w/proportional heat (continuous operation)	A4
Cooling w/night cycle	A5
Cooling w/morning warm-up and night cycle	A6
Cooling w/staged electric, auxiliary or on-off hot water heat and night cycle	A7
Cooling w/proportional heat and night cycle	A8
Cooling w/auto night shutdown	B1
Cooling w/morning warm-up and auto night shutdown	B2
Cooling w/staged electric, auxiliary or on-off hot water heat and auto night shutdown	B3
Cooling w/proportional heat and auto night shutdown	B4
Cooling w/auto night setback cycle	B5
Cooling w/morning warm-up and auto night setback cycle	B6
Cooling w/staged electric, auxiliary or on-off hot water heat and auto night setback cycle	B7
Cooling w/proportional heat and auto night setback cycle	B8
Cooling w/staged electric, auxiliary or on-off hot water heat, auto night setback cycle and morning warm-up	B9
Cooling w/proportional heat, auto night setback cycle and morning warm-up	B10
Cooling w/staged electric, auxiliary or on-off hot water heat and morning warm-up (continuous operation)	B23
Cooling w/proportional heat and morning warm-up (continuous operation)	B24
Cooling w/staged electric, auxiliary or on-off hot water heat, auto night shutdown and morning warm-up	B25
Cooling w/proportional heat, auto night shutdown and morning warm-up	B26
Cooling w/auto changeover (continuous operation)	B13
Cooling w/staged electric, auxiliary or on-off hot water heat and auto changeover (continuous operation)	B17
Cooling w/proportional heat and auto changeover (continuous operation)	B18
Cooling w/auto changeover and auto night shutdown	B15
Cooling w/staged electric, auxiliary or on-off hot water heat, auto changeover and auto night shutdown	B16
Cooling w/proportional heat, auto central heating changeover and auto night shutdown	B22

Sequence Notes:

Morning Warm-Up

A duct stat is mounted in the terminal inlet. Upon sensing a central system supply air temperature above 77°F (25°C), the primary air damper drives to a full open position. Optional terminal supplementary heat is locked out. Upon sensing cool air, the terminal reverts to daytime operation.

Auxiliary or On-off Hot Water Heat

Control relay provides a 24 VAC output signal for operation of valve (10 VA maximum by others).

Proportional Hot Water Heat

Thermostat heating output provides an 0 – 10 Vdc reverse acting control signal to proportional valve (by others). Closed at 0 Vdc and fully open at 10 Vdc (10 mA maximum).

Night Cycle

An airflow switch de-energizes fan upon loss of primary (central system) air. Upon a call for heat, the thermostat will override the airflow switch and cycle the unit fan followed by any supplementary heat intermittently to maintain day set point temperature.

Auto Night Shutdown

An airflow switch de-energizes fan upon loss of primary (central system) air and locks out any optional supplementary heat.

Auto Night Setback

An airflow switch de-energizes fan upon loss of primary (central system) air and activates the night side of the thermostat. Primary air damper cycles closed. Upon a call for heat, the thermostat will override the airflow switch and cycle the unit fan and optional supplementary heat intermittently to maintain a lower energy saving setback temperature.

Auto Changeover

(Central Heat/Cool Systems)

These sequences incorporate a duct stat and heat/cool thermostat. Upon sensing a central system supply air temperature above 77°F (25°C), the heating side of the thermostat is activated and the damper throttling action is reversed. Warm central air is modulated between minimum and maximum set points.

Optional Strategies

Night setback, night shutdown and primary damper overrides may be initiated by external 24 VAC inputs and/or dry contact closures.

Consult your Nailor representative for non-standard control sequences.

Standard Control Sequences • Fan Powered Terminal Units • Parallel Flow

Model Series 35N and 37N

Analog Electronic Sequences

Code	Description
A1	Cooling w/night cycle
A2	Cooling w/morning warm-up and night cycle
A3	Cooling w/staged electric, auxiliary or on-off hot water heat and night cycle
A4	Cooling w/proportional heat and night cycle
B1	Cooling w/auto night shutdown
B2	Cooling w/morning warm-up and auto night shutdown
B3	Cooling w/staged electric, auxiliary or on-off hot water heat and auto night shutdown
B4	Cooling w/proportional heat and auto night shutdown
B5	Cooling w/auto night setback cycle
B6	Cooling w/morning warm-up and auto night setback cycle
B7	Cooling w/staged electric, auxiliary or on-off hot water heat and auto night setback cycle
B8	Cooling w/proportional heat and auto night setback cycle
B9	Cooling w/staged electric, auxiliary or on-off hot water heat, auto night setback cycle and morning warm-up
B10	Cooling w/proportional heat, auto night setback cycle and morning warm-up
B23	Cooling w/staged electric, auxiliary or on-off hot water heat and morning warm-up
B24	Cooling w/proportional heat, morning warm-up and night cycle
B25	Cooling w/staged electric, auxiliary or on-off hot water heat, auto night shutdown and morning warm-up
B26	Cooling w/proportional heat and morning warm-up
B13	Cooling w/auto changeover
B17	Cooling w/staged electric, auxiliary or on-off hot water heat and auto changeover
B18	Cooling w/proportional heat and auto changeover
B15	Cooling w/auto changeover and auto night shutdown
B16	Cooling w/staged electric, auxiliary or on-off hot water heat, auto changeover and auto night shutdown
B22	Cooling w/proportional heat, changeover and auto night shutdown

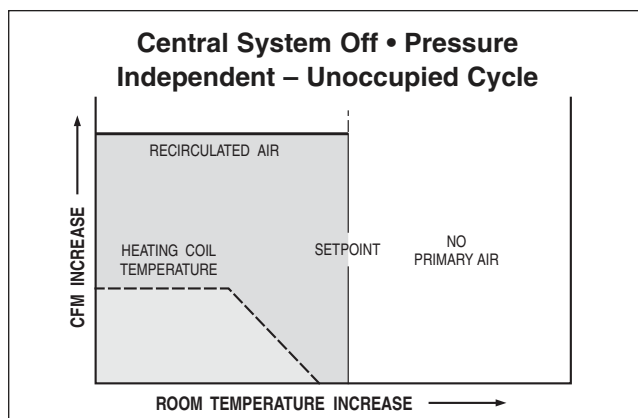
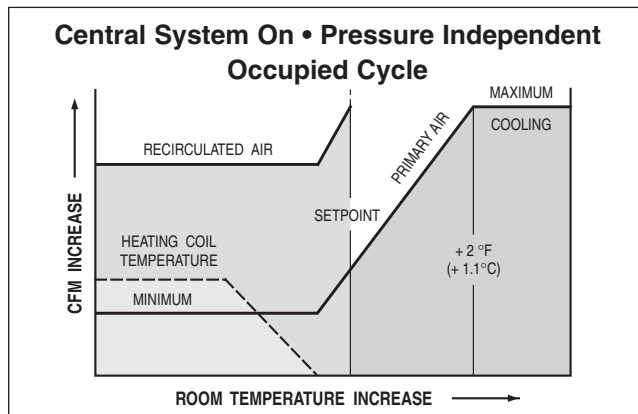

Sequence Notes:

Morning Warm-Up

A duct stat is mounted in the terminal inlet. Upon sensing a central system supply air temperature above 77°F (25°C), the primary air damper drives to a full open position. Fan and optional supplementary heat are locked out. Upon sensing cool air, the terminal reverts to daytime operation.

Night Cycle

Upon a call for heat, the thermostat will cycle the unit-fan followed by any supplementary heat intermittently to maintain day set point temperature.

Auto Night Setback

An airflow switch senses central system shutdown upon loss of primary air and activates the night side of the thermostat. Primary air damper cycles closed. Upon a call for heat, the thermostat will cycle the unit fan and optional supplementary heat intermittently to maintain a lower energy saving setback temperature.

Auto Changeover

(Central Heat/Cool Systems)

These sequences incorporate a duct stat and heat/cool thermostat. Upon sensing a central system supply air temperature above 77°F (25°C), the heating side of the thermostat is activated and the damper throttling action is reversed. Warm central air is modulated between minimum and maximum set points. Terminal fan and optional supplementary heat are locked out.

Optional Strategies

Night setback, night shutdown and primary damper overrides may be initiated by external 24 VAC inputs and/or dry contact closures. Consult your Nailor representative for non-standard control sequences.

Standard Control Sequences • Bypass Terminal Units

Analog Electronic • Pressure Dependent

Control Sequence E2

Cooling Only

Central system supplies cool air. On a rise in room temperature above set point, the bypass damper will slowly modulate open, increasing the flow of air to the room, closing the bypass at the same time. On a fall in room temperature below set point, the bypass damper will modulate closed, reducing the flow of cool air into the room and opening the bypass at the same time. A mechanical air volume minimum stop is provided (field set).

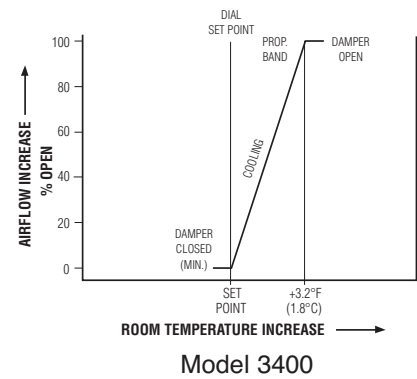

Control Sequence E3

Automatic Heating/Cooling Changeover

This arrangement is for systems supplying cool air in summer and hot air in winter. A duct temperature sensor senses inlet temperature and automatically reverses control action when supply air is above 78°F (26°C). A mechanical air volume minimum stop is provided (field set).

Cooling Mode:

Supply air system in cooling mode (below 75°F (24°C)). On a rise in room temperature above set point, the bypass damper will modulate open, increasing the flow of cool air to the room, closing the bypass at the same time. On a fall in room temperature below set point, the bypass damper will modulate closed, reducing the flow of cool air into the room and opening the bypass at the same time.

Heating Mode:

Supply air system in heating mode (above 78°F (26°C)). On a rise in room temperature above set point, the bypass damper will modulate closed, reducing the flow of warm air into the room to maintain set point and opening the bypass. On a fall in room temperature below set point, the bypass damper will modulate open, increasing the flow of warm air into the room to maintain the set point and closing the bypass at the same time.

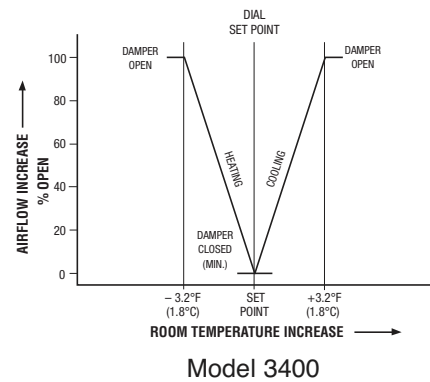

Control Sequence E4

Cooling with On/Off Auxiliary Heat (Perimeter) or Hot Water Reheat

Central system supplies cool air. On a rise in room temperature above set point, the bypass damper will slowly modulate open, increasing the flow of air to the room, closing the bypass at the same time. On a fall in room temperature below set point, the bypass damper will modulate closed, reducing the flow of cool air into the room and opening the bypass at the same time.

If room temperature continues to fall, the thermostat will energize the control relay/valve of the perimeter heating or hot water valve for reheat. A mechanical air volume minimum stop is provided (field set).

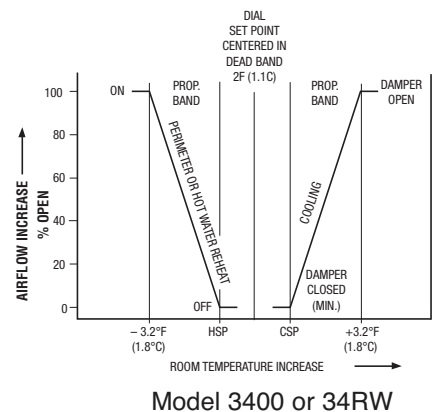

Standard Control Sequences • Bypass Terminal Units

Analog Electronic • Pressure Dependent

Control Sequence E5

Automatic Heating/Cooling Changeover with On/Off Auxiliary Heat (Perimeter) or Hot Water Reheat

This arrangement is for systems supplying cool air in summer and hot air in winter. A duct temperature sensor senses inlet temperature and automatically reverses control action when supply air is above 78°F (26°C). A mechanical air volume minimum stop is provided (field set).

Cooling Mode:

Supply air system in cooling mode (below 75°F (24°C)). On a rise in room temperature above set point, the bypass damper will modulate open, increasing the flow of cool air to the room, closing the bypass at the same time. On a fall in room temperature below set point, the bypass damper will modulate closed, reducing the flow of cool air into the room and opening the bypass at the same time. If room temperature continues to fall, the thermostat will energize the control relay/valve of the perimeter heating or hot water reheat valve for reheat.

Heating Mode:

Supply air system in heating mode (above 78°F (26°C)). On a rise in room temperature above set point, the bypass damper will modulate closed, reducing the flow of warm air into the room to maintain set point and opening the bypass. On a fall in room temperature below set point, the bypass damper will modulate open, increasing the flow of warm air into the room to maintain the set point and closing the bypass at the same time. If room temperature continues to fall, the thermostat will energize control relay/valve of the perimeter heating or the hot water valve for supplementary heat.

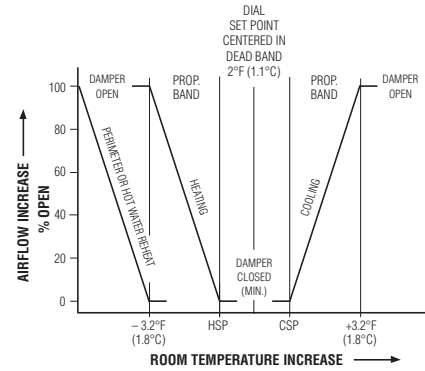

Model 3400 or 34RW

Control Sequence E6

Automatic Heating/Cooling Changeover with Time Proportional Electric Auxiliary Heat (Perimeter)

This arrangement is for systems supplying cool air in summer and hot air in winter. A duct temperature sensor senses inlet temperature and automatically reverses control action when supply air is above 78°F (26°C).

Cooling Mode:

Supply air system in cooling mode (below 75°F (24°C)). On a rise in room temperature above set point, the bypass damper will modulate open, increasing the flow of cool air to the room, closing the bypass at the same time. On a fall in room temperature below set point, the bypass damper will modulate closed, reducing the flow of cool air into the room and opening the bypass at the same time. If room temperature continues to fall, a SCR/SSR controlled electric heat coil is energized.

Heating Mode:

Supply air system in heating mode (above 78°F (26°C)). On a rise in room temperature above set point, the bypass damper will modulate closed, reducing the flow of warm air into the room to maintain set point and opening the bypass. On a fall in room temperature below set point, the bypass damper will modulate open, increasing the flow of warm air into the room to maintain the set point and closing the bypass at the same time. If room temperature continues to fall, a SCR/SSR controlled electric heating coil is energized.

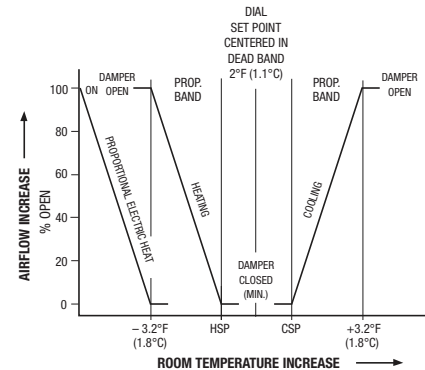

Model 3400

CONTROLS
F

Standard Control Sequences • Bypass Terminal Units

Analog Electronic • Pressure Dependent

Control Sequence E6

Automatic Heating/Cooling Changeover with Time Proportional Electric Reheat

This arrangement is for systems supplying cool air in summer and hot air in winter. A duct temperature sensor senses inlet temperature and automatically reverses control action when supply air is above 78°F (26°C).

Cooling Mode:

Supply air system in cooling mode (below 75°F (24°C)). On a rise in room temperature above set point, the bypass damper will modulate open, increasing the flow of cool air to the room, closing the bypass at the same time. On a fall in room temperature below set point, the bypass damper will modulate closed, reducing the flow of cool air into the room and opening the bypass at the same time. If room temperature continues to fall, a SCR/SSR controlled electric heat coil is energized.

Heating Mode:

Supply air system in heating mode (above 78°F (26°C)). On a rise in room temperature above set point, the bypass damper will modulate closed, reducing the flow of warm air into the room to maintain set point and opening the bypass. On a fall in room temperature below set point, the bypass damper will modulate open, increasing the flow of warm air into the room to maintain the set point and closing the bypass at the same time. If room temperature continues to fall, a SCR/SSR controlled electric heating coil is energized.

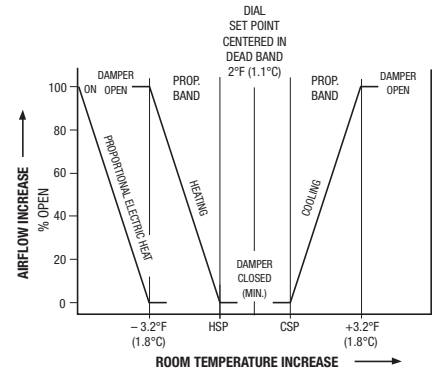

Control Sequence E7

Cooling with One Stage Electric Reheat

Central system supplies cool air. On a rise in room temperature above set point, the bypass damper will slowly modulate open, increasing the flow of air to the room, closing the bypass at the same time. On a fall in room temperature below set point, the bypass damper will modulate closed, reducing the flow of cool air into the room and opening the bypass at the same time.

If room temperature continues to fall, the thermostat will energize the control relay of the electric reheat coil.

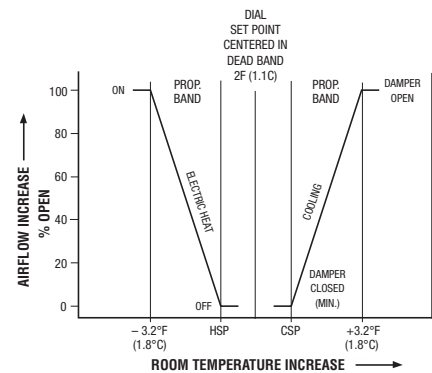

Control Sequence E8

Automatic Heating/Cooling Changeover with One Stage Electric Reheat

This arrangement is for systems supplying cool air in summer and hot air in winter. A duct temperature sensor senses inlet temperature and automatically reverses control action when supply air is above 78°F (26°C).

Cooling Mode:

Supply air system in cooling mode (below 75°F (24°C)). On a rise in room temperature above set point, the bypass damper will modulate open, increasing the flow of cool air to the room, closing the bypass at the same time. On a fall in room temperature below set point, the bypass damper will modulate closed, reducing the flow of cool air into the room and opening the bypass at the same time. If room temperature continues to fall, the electric heat is energized.

Heating Mode:

Supply air system in heating mode (above 78°F (26°C)). On a rise in room temperature above set point, the bypass damper will modulate closed, decreasing the flow of cool air to the room and opening the bypass at the same time. On a fall in room temperature below set point, the bypass damper will modulate open, increasing the flow of warm air into the room and closing the bypass at the same time. If room temperature continues to fall, the electric heat is energized.

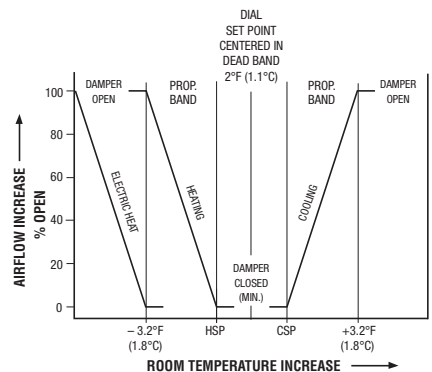

Standard Control Sequences • Bypass Terminal Units

Analog Electronic • Pressure Dependent

Control Sequence E10

Cooling with Time Proportional Electric Auxiliary Heat (Perimeter)

This arrangement is for systems supplying cool air in summer and in winter. On a rise in room temperature above set point, the bypass damper will modulate open, increasing the flow of cool air to the room, closing the bypass at the same time. On a fall in room temperature below set point, the bypass damper will modulate closed, reducing the flow of cool air into the room and opening the bypass at the same time. If room temperature continues to fall, a SCR/SSR controlled electric heat coil is energized.

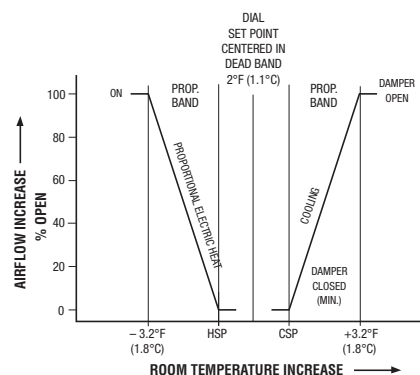

Model 3400

Control Sequence E10

Cooling with Time Proportional Electric Reheat

This arrangement is for systems supplying cool air in summer and in winter. On a rise in room temperature above set point, the bypass damper will modulate open, increasing the flow of cool air to the room, closing the bypass at the same time. On a fall in room temperature below set point, the bypass damper will modulate closed, reducing the flow of cool air into the room and opening the bypass at the same time. If room temperature continues to fall, a SCR/SSR controlled electric heat coil is energized.

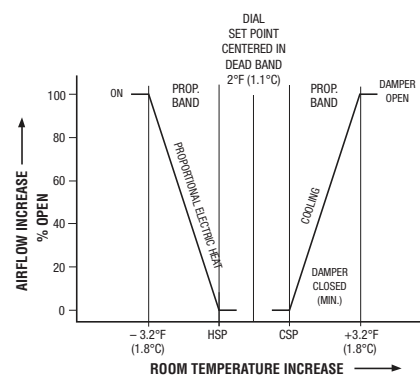

Model 34RE

Pneumatic Controls (by Nailor)

A comprehensive range of factory supplied, installed and calibrated controls are available for pressure independent control applications with all terminal types. Pressure dependent controls are also available for certain terminals and applications.

Pressure Dependent pneumatic air terminal actuators are controlled directly by branch line pressure signals from the room thermostat. They do not compensate for static pressure changes immediately upstream of the terminal. Consequently, the thermostat is a damper blade positioner rather than a flow regulator.

Pressure Independent pneumatic air terminal actuators are controlled directly by a flow control device which balances velocity pressure readings from a flow sensor located at the inlet and branch air pressure from the thermostat. The controller operates within adjustable minimum and maximum flow rates.

The most commonly used thermostat is a **Direct Acting Thermostat** which causes an increase in output pressure as room temperature rises. A Reverse Acting Thermostat causes a decrease in output pressure as room temperature rises. Since the pneumatic actuator is a spring return device, the damper may be connected so that it returns either to a normally closed position (shutting off primary air) upon loss of main air, or to a normally open position upon loss of main air (allowing a central system morning warm up sequence).

The standard and recommended **Nailor 3000 Universal Controller** is a multi-function device and has a constant reset span (factory set at 5 psi) regardless of maximum and minimum flow setting for superior temperature control. The controller is suitable and may be field modified for use with either a direct or reverse acting thermostat and with either a normally open or normally closed primary air damper.

With pressure independent controls (unlike pressure dependent), the damper normal position is not related to the thermostat action.

The selection of direct or reverse acting thermostats are most commonly dictated by the desire for supplementary heat to fail "open" or "off" (using a reverse acting thermostat) or to fail "closed" or "on" (using a direct acting thermostat). A pneumatic-electric (P.E.) switch is an integral part of the 35NE control sequence. When the primary air damper approaches its minimum flow position, the P.E. switch is activated to energize the fan.

If supplementary heat is present on 35NE (or 35SE models), additional P.E. switches are sequenced to activate the stages of electric heat. For hot water heat a pneumatic hot water valve (by others) is required.

P.E. switches are wired normally closed with a direct acting thermostat, so that the fan and optional heat fail in an "on" position. With a reverse acting thermostat, the P.E. switches are wired normally open to fail in an "off" position.

Pressure Independent Operation

The heart or 'brain' of the control package is the reset controller, which processes signals from the room thermostat (temperature) and 'Diamond Flow' sensor and resets the primary air damper accordingly.

Airflow is controlled in response to the thermostat demand for heating and cooling to accurately meet the load conditions. At the same time, it holds the airflow rate dictated by the thermostat, regardless of fluctuations in upstream duct pressure. In other words, it is pressure independent. The flow control or reset function is between the minimum and maximum air volume limits. These limits are factory set to the job specification, but can be easily readjusted in the field as required.

In operation, the amplifying sensor located in the terminal inlet signals to the pneumatic reset controller which in turn energizes the pneumatic damper actuator to obtain the required airflow. There is actually a pressure signal feedback to the controller as a result of the damper movement which will correct itself for any velocity pressure fluctuations. Hunting and over controlling are minimized, resulting in stable operating conditions.

Nailor 3000 Controller

Traditionally, the industry's most popular model. Universal pneumatic reset controller (**Model CSC-3011**) compensates for changes in duct pressure-flow. Control is pressure independent with adjustable minimum and maximum air volume settings. Can be used for any combination of direct or reverse acting thermostat action with a normally open or normally closed damper fail position.



Nailor 3000 Controller

Features:

- The controller is factory calibrated to the specified airflow, and is field adjusted easily. Field adjustment is needed only when operating conditions change.
- Pressure independent.
- Reset span remains constant with both maximum and minimum cfm adjustments.
- Reset span is adjustable from 0 to 10 psi (69 kPa) to match any thermostat. Standard setting is 5 psi (35 kPa).
- Reset start point is adjustable from 0 to 10 psi (69 kPa) to work with auxiliaries such as reheat coils. Standard setting is 8 psi (55 kPa).
- Settings for either direct acting or reverse acting thermostat action. Settings for either normally-open or normally-closed damper position, without further controls.
- Accurate control over a duct velocity range of 0–3000 fpm (15 m/s).

Pneumatic Controls (by Nailor) (continued)

- Adjustments are made on the face of the controller.
- Adjustments are directly accessible through a ceiling opening with controls mounted and facing downward.
- Operates at low system pressure. Effective from as low as 0.02" w.g. (5 Pa) Ps and as high as 6.0" w.g. (1.5 kPa) Ps.
- Control air consumption is no more than 1.0 SCFH @ 20 psi (0.472 l/min @ 138 kPa).
- Operates on a control air pressure of 15 to 30 psi (103 to 207 kPa).

All pneumatic velocity controllers are not equal

Often an otherwise well designed HVAC system doesn't perform as well as expected, mainly because the reset span (throttling range) of the velocity controllers is too narrow.

Some conventional controllers will modulate over a full 5 psi reset span only when the maximum cfm limit is set at 100% of the terminal unit's capability. Other controllers have a full 5 psi reset span only when the minimum cfm limit is zero. The reset span may also be affected by both the maximum and minimum setting.

Under normal operating conditions the maximum cfm limit is more often set at less than 100% (typically 60 – 80%) of the unit's capability, and the minimum may be above zero. As a result, there are many controllers with working reset spans of only a fraction of 5 psi (see example 1).

This situation is analogous to oversizing a valve so that all of its regulating must be done in a nearly closed position. Accurate control is difficult at best, because of practical limits to the sensitivity of a thermostat.

The Nailor 3000 Solution

The **Nailor 3000** universal controller always modulates through the full reset span, regardless of the maximum or minimum cfm setting. Hunting is avoided. (See example 1).

The reset span can be adjusted from 3 to 10 psi (5 psi is standard). It is then held constant, even if the cfm settings are changed.

Also, the reset start point is adjustable to match various thermostat throttling ranges such as 3 – 8, 5 – 10 or 8 – 13 psi and to co-ordinate with auxiliaries such as heating coils.

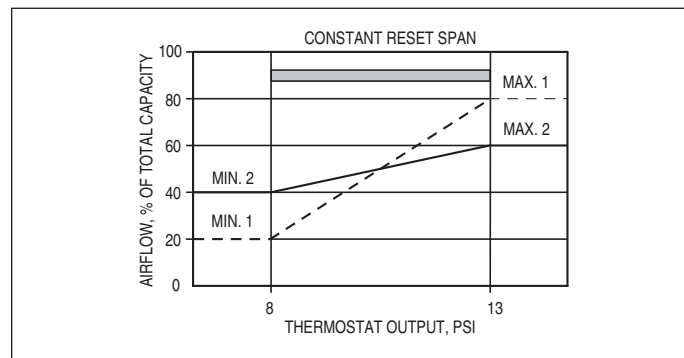

Example 1. Nailor 3000 Controller

Reset span remains constant regardless of minimum and maximum flow settings.

MCP-8031 Series Actuator

Piston type spring return pneumatic damper actuator; totally enclosed all metal casing with neoprene diaphragm. (8 sq. inch effective area). Standard 5 – 10 psi spring range on pressure independent reset controller applications, maximizes performance. Standard on all single duct, dual duct and fan powered pneumatic control terminal units.

MCP-8031-3101 5 – 10 psi spring range

MCP-8031-5101 8 – 13 psi spring range

MCP-8031-8101 3 – 8 psi spring range

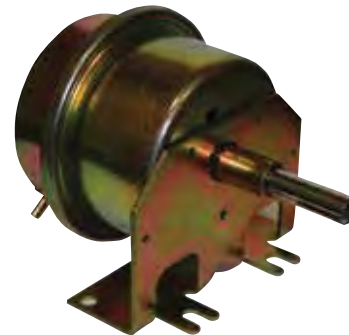

Model Series MCP-8301

MCP-3631 Series Rotary Actuator

Unique rotary-drive design with spring return action upon main air failure. Glass-filled nylon body with neoprene diaphragm (8 sq. inch effective area). Direct drive operation eliminates any possible linkage play. Compact design is suited to tight or restricted installations, such as internal retrofit applications. Standard on 3200 Series Dual Duct and 3400 Mk II Series Bypass terminal units. Optional on other models.

MCP-3631-3000 5 – 10 psi spring range

MCP-3631-5000 8 – 13 psi spring range

MCP-3631-8000 3 – 8 psi spring range



Model Series MCP-3631

Pressure Dependent Operation

In pressure dependent control operation, the pneumatic controller and flow sensor are omitted and the pneumatic actuator is controlled directly by the thermostat. Airflow is entirely pressure dependent. This version of the pneumatic terminal unit is used where neither pressure independent nor regulated maximum airflow settings are required.

One example is a single duct variable air volume supply in which the supply duct pressure is held constant by other controls. A mechanical airflow setting can be made as a function of the damper driveshaft rotation. Bypass terminal units, due to their design, are inherently pressure dependent.

Standard Control Sequences • Single Duct Terminal Units

Pneumatic • Pressure Independent • Nailor 3000 Controller

The sequences illustrated feature the Nailor 3000 controller and a constant 5 psi reset span which does not vary with minimum and maximum settings. For a more detailed explanation of control options and terminology, refer to the engineering section in the back of this catalog.

Control Sequence 1P3

Direct Acting, Normally Open

- When main control air is off, damper is fully open. Morning warm-up setting (if required) with warm air from system supplied at full flow rate.
- Main control air on – controller is activated. Begins modulating cold airflow on thermostat demand.
- Increase in room temperature increases thermostat output pressure (thus increasing airflow).
- Minimum airflow is maintained between 0 and 8 psi thermostat signal.
- Further increase in room temperature will increase thermostat signal from 8 to 13 psi which will increase airflow. At 13 psi and above, preset maximum airflow is maintained.
- If main control air fails, damper fails open.

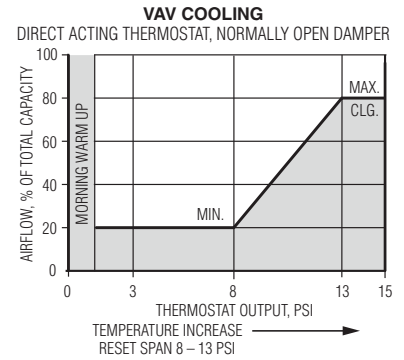

Control Sequence 2P3

Reverse Acting, Normally Open

- When main control air is off, damper is fully open. Morning warm-up setting available if required.
- Main control air on – controller is activated. Begins modulating cold airflow according to thermostat output.
- Decrease in room temperature increases thermostat output pressure (thus decreasing airflow).
- Maximum airflow is maintained between 0 and 3 psi thermostat signal.
- Further decrease in room temperature will increase thermostat signal from 3 to 8 psi which will decrease airflow to room. At 8 psi and above, minimum airflow is maintained.
- If main control air fails, damper fails open.

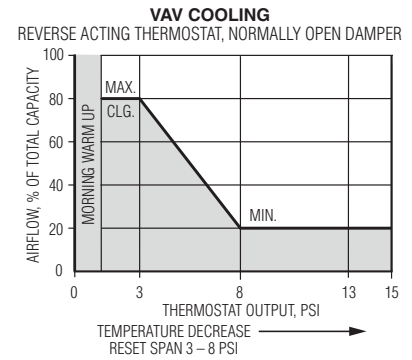

Control Sequence 3P3

Direct Acting, Normally Closed

- When main control air is off, damper is closed.
- Main control air on – controller is activated. Begins modulating cold airflow according to thermostat demand.
- Increase in room temperature increases thermostat output pressure (thus increasing airflow).
- Minimum airflow is maintained between 0 and 8 psi thermostat signal.
- Further increase in room temperature will increase thermostat signal from 8 to 13 psi which in turn increases airflow to room. At 13 psi and above, preset maximum airflow is maintained.
- If main control air fails, damper fails closed.

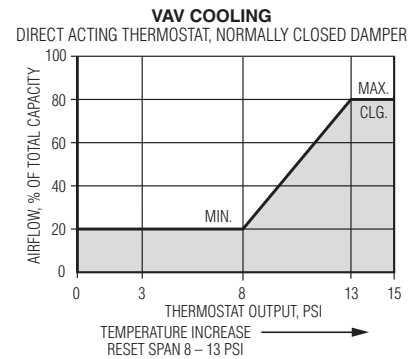

Control Sequence 4P3

Reverse Acting, Normally Closed

- When main control air is off, damper is closed.
- Main control air on – controller is activated. Begins modulating cold airflow according to thermostat demand.
- Decrease in room temperature increases thermostat output pressure (thus decreasing airflow).
- Maximum airflow is maintained between 0 and 3 psi thermostat signal.
- Further decrease in room temperature will increase thermostat output pressure from 3 to 8 psi which will decrease airflow to room. At 8 psi and above, minimum airflow is maintained.
- If main control air fails, damper fails closed.

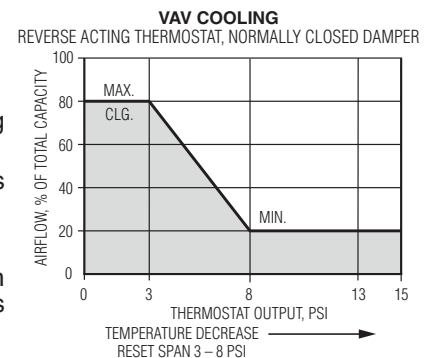

Standard Control Sequences • Single Duct Terminal Units Pneumatic • Pressure Independent • Nailor 3000 Controller

Control Sequence 1P3

D.A.N.O. - Hot Water Reheat N.O.

- When main control air is off, damper is fully open.
- Main control air on – controller is activated and begins modulating on thermostat demand.
- Increase in room temperature modulates hot water valve towards closed position (at 8 psi). Minimum airflow is maintained between 0 and 8 psi thermostat signal.
- Further increase in room temperature will increase thermostat signal from 8 to 13 psi which will increase airflow to maximum cooling.
- If main control air fails, damper fails open and hot water valve fails open.

Hot water reheat coils may also be sequenced with 2P3, 3P3 and 4P3.

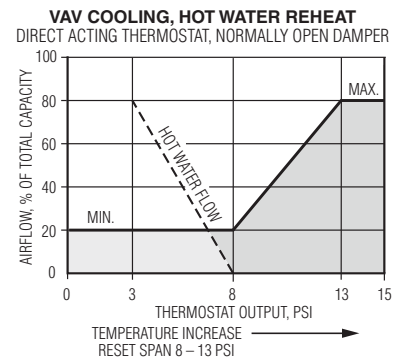

Control Sequence 1P3

D.A.N.O. - Electric Reheat N.C.

- When main control air is off, damper is fully open.
- Main control air on – controller is activated and begins modulating on thermostat demand.
- Increase in room temperature de-energizes the electric reheat coil one step at a time. Minimum airflow is maintained between 0 and 8 psi thermostat signal. At 8 psi, electric reheat is off.
- Further increase in room temperature will increase thermostat output signal from 8 to 13 psi which will increase airflow to maximum cooling.
- If main control air fails, damper fails open and P.E. switch for electric heater is closed (energized).

Electric reheat coils may also be sequenced with 2P3, 3P3 and 4P3.

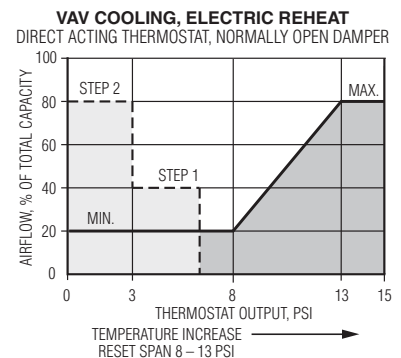

Control Sequence 7P3

C.V.N.C.

- When main control air is off, damper is closed.
- Main control air on – controller maintains preset constant airflow regardless of duct pressure or room temperature.
- A room thermostat is not used.
- If main control air fails, damper fails closed.
- A normally open damper assembly is optional.

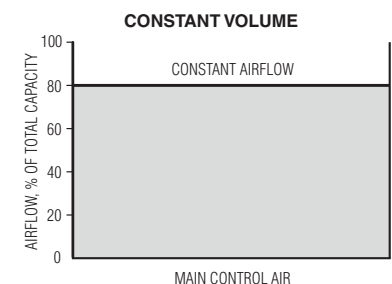

Control Sequence 8P3

C.V. - Hot Water Reheat N.O.

- When main air is off, damper is open.
- Main control air is on – controller maintains preset constant airflow regardless of duct pressure or room temperature.
- As room temperature increases, a room thermostat modulates the hot water valve towards the closed position, or opens it on temperature drop.
- If main control air fails, damper fails open and hot water valve fails open.

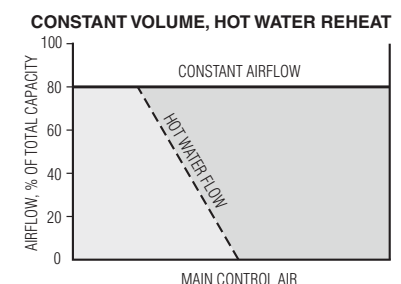

Standard Control Sequences • Dual Duct Terminal Units

Pneumatic • Pressure Independent • 3000 Controller

The typical control diagrams shown on this page represent the most commonly used dual duct control strategies. The schematics illustrate operation with a direct acting thermostat. Similar control sequences are available for use with reverse acting thermostats. Further variations for each sequence include right or left hand cold deck and damper failure state, normally open or normally closed upon loss of main air. Application specific control strategies are available from your Nailor representative.

Control Sequence DP1 • Model 3210

- Variable Volume – Hot and Cold Airflow without Mixing and Zero Minimum
- Hot and Cold Deck Inlet Sensing.

The hot and cold decks are set for equal or unequal maximum air volumes, with minimum setting of zero flow at 8 psi. With rise in room temperature the cold air damper will open to the preset maximum airflow in response to signals from room stat. The hot air damper will be closed. As the space temperature drops the cold air damper modulates to shut off at 8 psi and then the hot air damper begins to open. If the space temperature continues to drop, the hot air damper opens to the maximum setting. No mixing of hot or cold airflow occurs.

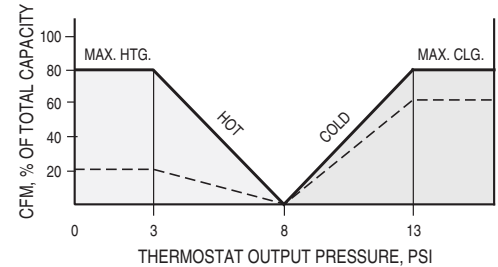

Control Sequence DP2 • Model 3230 and 3240

- Variable Volume – Hot and Cold Airflow with Mixing at Minimum Flow
- Total Air Sensing – In Common Discharge • (Hot Deck Make-up Illustrated)

The hot and cold decks may be for equal or unequal maximum air volumes. The cold duct minimum flow rate is set for zero at 8 psi, while the hot duct minimum setting at 8 psi may be set at any desired volume up to but not exceeding its maximum setting. As the hot duct sensor located downstream is measuring total airflow, when thermostat output pressure begins to exceed 8 psi and the cold deck begins to open, the hot duct damper starts closing again and holds total airflow at the hot duct minimum setting. As the cooling load increases and the cold deck continues to open, the cold airflow, which is not controlled by the downstream sensor, exceeds the hot duct minimum setting at which point the hot duct damper is fully closed.

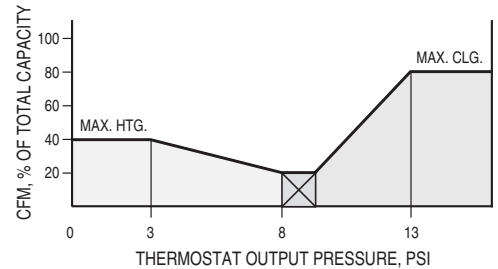

Control Sequence DP3 • Model 3230 and 3240

- Constant Volume – Mixing Hot and Cold Airflow
- Total Air Sensing – In Common Discharge • (Hot Deck Make-up Illustrated)

A downstream velocity sensor controls the hot deck and also holds total airflow of any hot-cold air mixture to a constant volume. Because the hot air velocity sensor is downstream of the unit, it directly measures the condition that is being controlled, i.e., total flow. The cold duct controls operate independently in response to signals from a room stat. The hot and cold deck maximum airflows are set for the same maximum flow rate. The hot deck minimum is set for zero flow at 13 psi. The cold deck minimum is set for zero flow at 8 psi. This arrangement will provide an extremely accurate constant volume flow cooling range over the entire heating and cooling range.

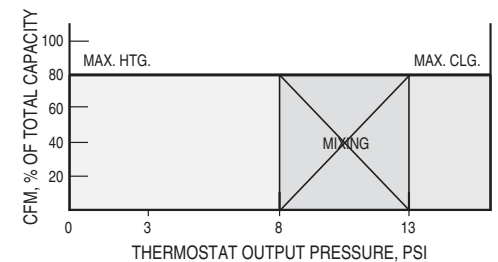

Standard Control Sequences • Fan Powered Terminal Units • Series Flow

Model Series 35S, 35SST, 37S and 37SST

Pneumatic • Pressure Independent

Occupied Cycle

1. The series terminal fan is directly or indirectly interlocked and energized before or when the central system starts up.

Nailor recommends that the terminal fan is indirectly interlocked by means of an airflow switch (optional) which senses primary air pressure at the inlet. Upon central system start up, the fan in the terminal is automatically energized.

2. On a rise in room temperature, the thermostat sends a signal to increase the flow of cold primary air.

3. As more cold air is supplied to the fan section, less warm air is induced from the ceiling space or plenum.

4. When the room temperature exceeds the set point by 2°F or more, cold airflow is maintained at the maximum setting. The maximum setting is the same as the total fan volume setting.

5. On a decrease in room temperature, the thermostat sends a signal to decrease the flow of cold primary air.

6. As less cold air is supplied to the fan section, more warm air is induced from the ceiling space.

7. When the room temperature and thermostat output signal reach the thermostat set point, the cold airflow is at its minimum limit (usually zero) and the fan is supplying the maximum volume of induced air.

8. If room temperature continues to drop, an optional heating coil may be energized.

9. When the optional airflow switch is supplied and the central system is turned off (night-time or weekend), the series terminal fan is shut down upon loss of primary air.

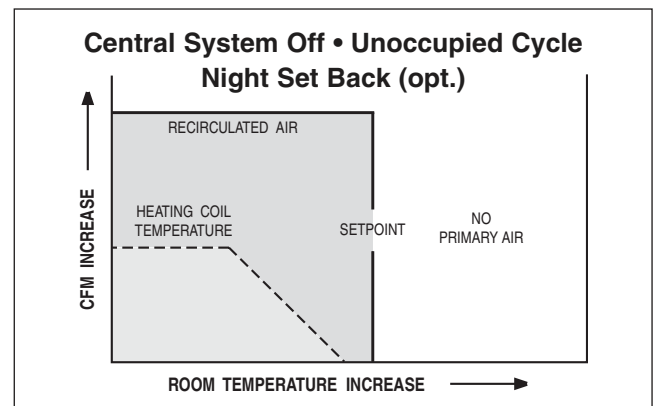
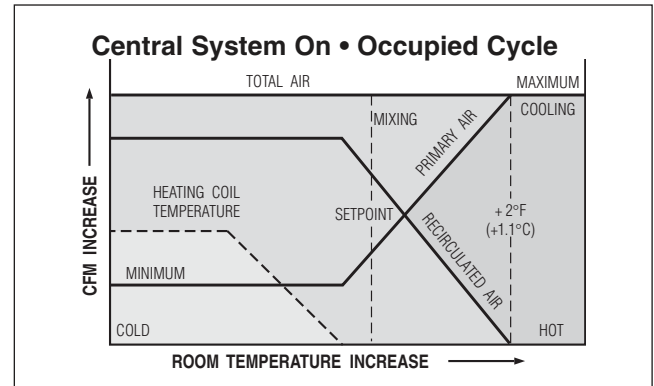

Pneumatic Options

1. Night Shutdown (Airflow Switch). Accessory code: QK.

An airflow switch de-energizes fan upon loss of primary (central) air (indirect fan interlock). The terminal fan will remain off until the primary air is restored.

2. Night Shutdown (P.E. Switch). Accessory code: QL.

A pneumatic electric switch de-energizes the fan upon loss of main air. Primary air fan must be shut down. The terminal fan will remain off until the main air is restored. Units with electric heat require reverse acting thermostats to prevent heat operation when terminal fan is off.

3. Night Setback (P.E. and Airflow Switch). Acc. code: QM.

Airflow switch de-energizes fan upon loss of primary (central) air. A P.E. switch overrides the airflow switch upon a call for heating and will cycle the unit fan followed by the supplementary heat intermittently in response to the night setback thermostat.

4. Night Setback (Two P.E.'s). Accessory code: QN.

A P.E. switch de-energizes fan upon loss of main air. Primary air fan must be shut down. A second P.E. switch provides an override upon a call for heating and will cycle the unit fan and supplementary heat in response to a separate pneumatic signal or night setback thermostat.

Pneumatic Sequence (Pressure Independent)			Code
Thermostat Action	Damper Fail Position	Electric or Hot Water Heat Option	
D.A.	NO	YES	1P3
R.A.	NO	YES	2P3
D.A.	NC	YES	3P3
R.A.	NC	YES	4P3

Standard Control Sequences • Fan Powered Terminal Units • Parallel Flow

Model Series 35N and 37N

Pneumatic • Pressure Dependent

The actuator and fan respond directly to a signal from the room thermostat.

P.E. switches are furnished to sequentially activate fan and optional hot water heat upon demand (electric heat is not available with pressure dependent controls).

Pneumatic • Pressure Independent

Occupied Cycle

1. Upon start-up of the central system, cold air is delivered to the space through the primary air section at the flow rate dictated by the thermostat. The reset controller compensates for any variation in inlet static pressure. The fan remains off. A backdraft damper at the fan outlet prevents cold air from flowing back through the fan into the ceiling space.
2. On a rise in room temperature, the thermostat sends a signal to increase the flow of primary air.
3. When the room temperature exceeds set point by 2°F or more, cold airflow is maintained at the maximum setting.
4. On a decrease in room temperature, the thermostat sends a signal for less cooling to the flow controller and cold airflow begins to decrease.
5. When the room temperature is at or below the thermostat set point, cold airflow is at its minimum limit.
6. If room temperature continues to drop, the fan section is energized to supply warm ceiling plenum air.
7. If room temperature drops further still, an optional supplementary heating coil may be energized.
8. When the central system is turned off (night-time or weekend operation), the fan and optional heat can be energized by the room thermostat on an intermittent basis on a call for heating.

Pneumatic Options

1. Night Setback

The space temperature may be reset to a lower setting through a change in main air pressure. The fan and optional heat will be energized through the P.E. switch furnished with the unit while the central system remains off.

2. A normally open damper configuration may be utilized for a central morning warm-up sequence by removing main air to the terminal.

Pneumatic Control Combinations

Pressure Dependent	Pressure Independent	Thermostat Action	Terminal Damper	Primary Air Cooling Range Max. - Min.	Suggested Range Settings					Code
					Fan P.E. Switch**		Electric Heating Coil P.E. Off - On			
					Off - On Setting	Normal Position	1st Stage	2nd Stage	3rd Stage	
✓		D.A.	N.C.	15 - 10 psi	12 - 10/N.C.		10 - 8	9 - 7	8 - 6	D1
✓		R.A.	N.O.	5 - 10 psi	9 - 11/N.O.		11 - 13	12 - 14	13 - 15	D2
	✓	D.A.	N.O.	13 - 8 psi	10 - 8/N.C.		8 - 5	7 - 4	6 - 3	1P3
	✓	R.A.	N.O.	3 - 8 psi	6 - 8/N.O.		8 - 11	9 - 12	10 - 13	2P3
	✓	D.A.	N.C.	13 - 8 psi	10 - 8/N.C.		8 - 5	7 - 4	6 - 3	3P3
	✓	R.A.	N.C.	3 - 8 psi	6 - 8/N.O.		8 - 11	9 - 12	10 - 13	4P3

Notes: ** A normally closed (N.C.) P.E. switch fails on. A normally open (N.O.) P.E. switch fails off. Hot water coil valves (by others) should be selected to modulate through the desired heating range in sequence with the cooling range.

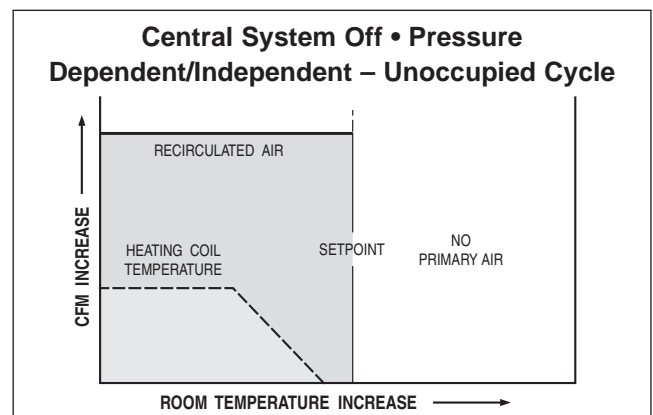
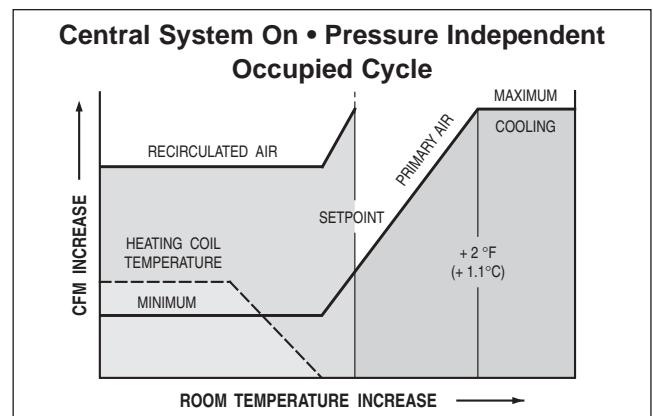
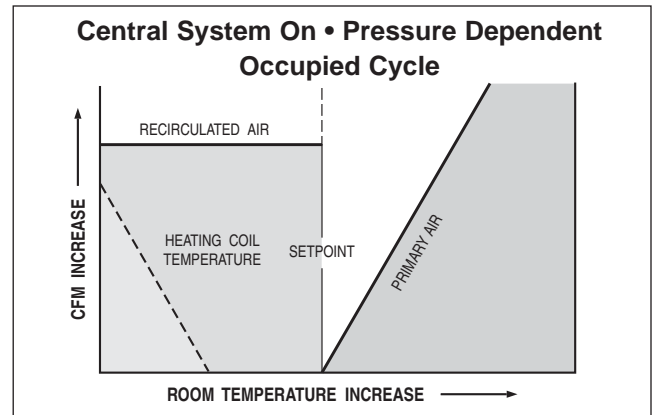

Standard Control Sequences • Bypass Terminal Units

Pneumatic • Pressure Dependent

A variety of popular sequences are illustrated to suit most applications. For non-standard or other specific applications, contact your Nailor representative.

Control Sequence P1

Cooling (with Optional Reheat) • Reverse Acting/Normally Open

- When main control air is off, damper is fully open and the bypass is closed.
- When main control air is on, cooling airflow modulates according to thermostat output.
- On a rise in room temperature, the thermostat line pressure to the actuator decreases. The actuator moves the damper to the open position, increasing the cooling airflow to the room, closing the bypass air at the same time.
- If the room thermostat is satisfied before the damper is fully open, the damper remains in a modulated position until further demand.
- On a fall in room temperature, the thermostat line pressure increases, moving the actuator to close the damper and decreases the cooling airflow to the room. At the same time, supply air is diverted through the bypass port into the plenum.
- A mechanical minimum stop requires field setting.
- An optional hot water coil valve or electric heater may be sequenced for reheat applications (8 – 13 psi). Hot water valve is supplied by others. P.E. switch is included in electric heater.

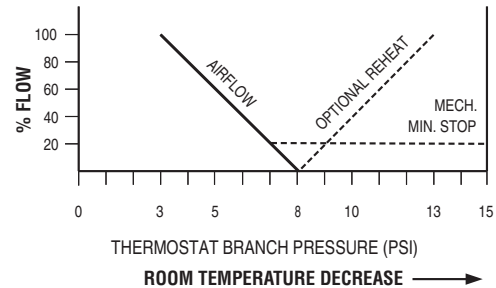

Control Sequence Package P1A

Cooling (with Optional Reheat) • Direct Acting/Normally Closed

- When main control air is off, damper is fully closed and the bypass is open.
- When main control air is on, cooling airflow modulates according to thermostat output.
- On a rise in room temperature, the thermostat line pressure to the actuator increases. The actuator moves the damper to the open position, increasing the cooling airflow to the room, closing the bypass air at the same time.
- If the room thermostat is satisfied before the damper is fully open, the damper remains in a modulated position until further demand.
- On a fall in room temperature, the thermostat line pressure decreases, moving the actuator to close the damper and decreases the cooling airflow to the room. At the same time, supply air is diverted through the bypass port into the plenum.
- A mechanical minimum stop requires field setting.
- An optional hot water coil valve or electric heater may be sequenced for reheat applications (3 – 8 psi). Hot water valve is supplied by others. P.E. switch is included in electric heater.

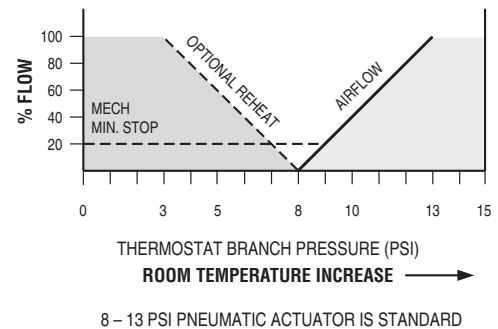

Electric Heater Controls

Nailor offers three control options for controlling electric heat on terminal units, conventional staged heat, SCR (Silicon Controlled Rectifier) and SCR with Discharge Temperature Control (DTC). All options provide a method for controlling, dependent on demand, the amount of heat needed within an occupied space. By adjusting the heat output into the occupied zone, energy is conserved by more precisely regulating output to closely match demand. Each control type subsequently requires a control signal, a control interface and device to energize heating coil elements.

Nailor's conventional staged heat works with digital (DDC), electronic and pneumatic control systems. A maximum of 3 stages are available. When heating is needed an on/off control signal typically 24 VAC, powers a mechanical contactor to energize a set of heating elements connected to line voltage. If the unit is equipped with more than one stage of heat, additional mechanical contactors can be triggered as demand requires. This setup allows for a wide range of line voltages as well as phase requirements needed to meet job specifications.

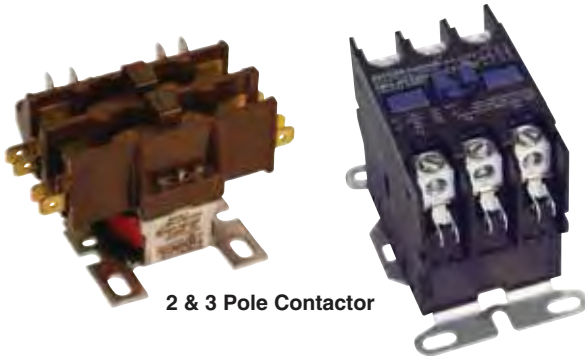

2 & 3 Pole Contactor

Nailor offers 2 versions of SCR proportional heat control, basic SCR and SCR with DTC. SCR heater controls provide proportional modulation over the full heater operating range. Since the SCR unit is controlled by solid state electronics, the control signal is very precise, reliable and silent. SCR control works with digital (DDC) (additional component required), analog and pneumatic controls packages. When heating is required, a control input signal is sent to the SCR controller board as 4-20mA, 2-10VDC or 0-10 VDC. In turn, a 1-24 VDC pulsed output will be sent to a single or multiple SSR's (Solid State Relay) to energize the heating elements. Simultaneously, all the heater elements will be pulsed on and off based on the time proportional signal from the SCR controller. The result is proportioned heat to meet demand, thus conserving energy.



SCR Controller with SSR

To further increase efficiency, Nailor offers an SCR controller with a DTC option. By measuring differential temperature across the heating coils, the SCR controller will update the proportional signal sent to the SSR's to ensure the heat output of the elements is optimized. As an added benefit and safety measure, during low flow situations the heater will de-energize if it detects too great a temperature differential across the heater. This saves both energy and costs as a mechanical airflow switch is no longer needed. The DTC option also has an adjustable potentiometer, which allows the controller to limit the maximum discharge air temperature of the heater, allowing you to meet the requirements of the ASHRAE standards. SCR heat is very precise, energy efficient, silent and compatible with modern controls packages.



SCR Controller with DTC

Electric Heating Coils

Application Guidelines

Discharge Air Temperature

When considering the capacity and airflow for the heater, discharge air temperature can be an important factor. Rooms use different types of diffusers and they are intended to perform different functions. Slots that blend the air at the glass and set up air curtains within the room, must be able to blow the air very low in the room. Hot air will be too buoyant to be effective in this case. Discharge air temperatures for this application should be in the 85 – 90°F (29 – 32°C) range.

Diffusers in the center of the room blend their discharge air as it crosses the ceiling. Discharge air temperatures in this application can be as high as 105°F (41°C) and still be effective. However, if the return air grilles are in the discharge air pattern, the warm air will be returned to the plenum before it heats the room. Again, the air temperature needs to be blended down to an acceptable temperature that can be forced down into the occupied space by the time the air gets to the walls. Discharging warm air into the room at temperatures above 105°F (41°C) usually will set up stratification layers and will not keep the occupants warm if there is a ceiling return because only the top 12" – 24" (300 – 600 mm) of the room will be heated.

The maximum approved discharge air temperature for any Nailor Fan Powered Terminal Unit with supplemental heat is 120°F (49°C). No heater should be applied to exceed this temperature.

Electric Heater Selection

To properly select an electric heater, three things must be determined: the heat requirement for the room, the entering air temperature and the desired discharge air temperature. The heat requirement for the room is the sum of the heat loss calculation and the amount of heat required to raise the entering air temperature to the desired room temperature. Usually, the second item is small compared to the first for fan powered terminal units in a return air plenum. MBH can be converted to kW by using the chart or by calculation. There are 3.413 MBH in 1000 kW. If using the chart, find the MBH on the left scale, then move horizontally to the right and read kW.

Next, the desired discharge air temperature should be ascertained. This will depend on the type of diffusers that are in the room.

The desired heating airflow for the room can then be calculated using the following equation:

$$\text{cfm} = \frac{\text{kW} \times 3160}{\Delta t \text{ (discharge air temp - inlet air temp.) } ^\circ\text{F}}$$

Assuming 70°F (21°C) supply air temperature to the heater, the room airflow can be selected directly from the chart. Start at the left at the design kW. Move horizontally to the desired discharge air temperature. Then, move vertically down to the cfm at the bottom of the chart.

The kW can be selected directly from the chart. Start at the bottom with the design cfm into the room. Move vertically up to the line that represents the desired discharge air temperature. Then, move left to the kW.

The discharge air temperature can also be selected directly from the chart. Start at the bottom with the design cfm into the room. Move to the left side of the chart and find the design kW. Move horizontally and vertically into the chart until the lines intersect. The intersection will be the desired discharge air temperature. Interpolation between the curves is linear.

Heater Selection Chart

Assuming 70°F inlet air temperature at heater.

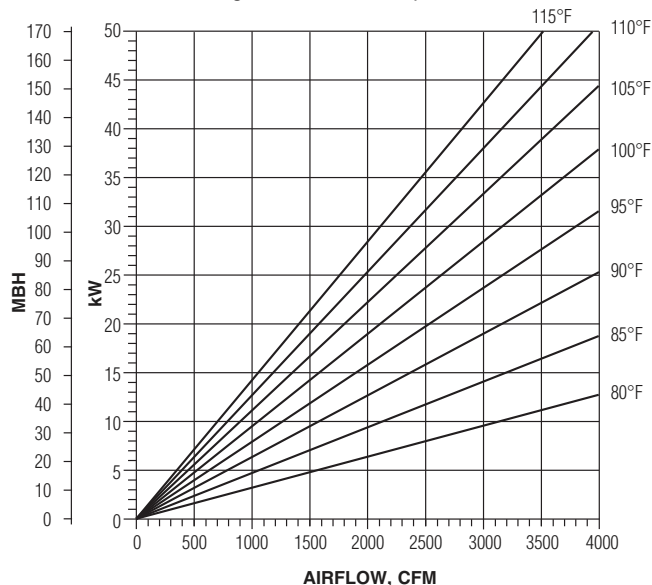

Diagonal lines are constant output temperature.

SUGGESTED SPECIFICATIONS

TABLE OF CONTENTS

	Page No.
Single Duct Terminal Units	
Basic Unit	G3
3001, 30RW, 30RE	
Quiet with Dissipative Silencer	G6
3001Q, 30RWQ, 30REQ	
Hospital Grade, Quiet with Dissipative Silencer	G10
30HQ, 30HQW, 30HQE	
Exhaust	G13
30X	
Exhaust, Hospital Grade, Quiet with Dissipative Silencer	G14
30HQX	
Dual Duct Terminal Units	
Basic Unit	G15
3210	
Compact Mixing Attenuator	G15
3230	
BlendMaster™ with High Efficiency Mixing Attenuator	G16
3240	
Control Specifications	G16
Fan Powered Terminal Units - Series Flow	
Chilled Water for DOAS	G18
33SZ, 33SZW, 33SZE	
Basic Unit	G20
35S, 35SW, 35SE	
"Stealth™"	G21
35SST, 35WST, 35EST	
Low Profile	G23
37S, 37SW, 37SE	
"Stealth™", Low Profile	G24
37SST, 37SWST, 37SEST	
Fan Powered Terminal Units - Parallel Flow	
Basic Unit	G25
35N, 35NW, 35NE	
Low Profile	G28
37N, 37NW, 37NE	
Retrofit Terminal Units	
Round	G31
36VRR	
Square and Rectangular	G32
36VRS	
Bypass Terminal Units	G32
3400	

Single Duct Terminal Units • 3000 Series

Model 3001 • Basic Unit

1. Furnish and install **Nailor 3000 Series Single Duct Variable Volume Terminal Units** of the sizes and capabilities as indicated on the drawings. Units shall be pressure independent with (DDC, analog electronic, pneumatic) controls. Units shall reset to any flow between minimum and the maximum cataloged airflow as allowed by the specific controller.
2. The entire terminal unit shall be designed and built as a single unit. The unit shall be provided with a primary variable air volume damper that controls the air quantity in response to a (DDC, analog electronic, pneumatic electric) thermostat. The unit shall also include all options such as electric or hot water heating coils, attenuators and access doors. The space limitations shall be reviewed carefully to insure that all units will fit into the space allowed.
3. Unit casing shall be 22 ga. (.86) galvanized steel with round, flat oval or rectangular inlets with 5 1/2" (140) deep inlet duct collar for field connection. Outlets shall be rectangular and configured for slip and drive connections. Casing leakage downstream of the damper shall not exceed 1% @ 1" w.g. (249 Pa). High side casing leakage shall not exceed 2% @ 3" w.g. (746 Pa).
4. Damper assemblies of 16 ga. (1.63) galvanized steel shall be multiple opposed blade construction arranged to close at 45 degrees from full open to minimize air turbulence and provide near linear operation. Damper blades shall be fitted with flexible seals for tight closure and minimized sound generation. Damper blades shall be screwed through the shaft to insure that no slippage occurs. Blade shafts shall pivot on corrosion free Celcon® bearings. In the fully closed position, air leakage past the closed damper shall not exceed 2% of the nominal catalog rating at 3" w.g. (746 Pa) inlet static pressure as rated by ASHRAE Standard 130.
5. The terminal units shall be capable of operation as described herein with a minimum inlet static pressure that shall not exceed .18" w.g. (45 Pa) @ 2000 fpm (10.2 m/s) inlet velocity. (The sequence of operations should be described here, if not part of the temperature controls specifications.) Each unit shall be complete with factory mounted (DDC, electric, analog electronic or pneumatic) controls. Gauge tap ports shall be supplied in the piping between the flow pick up and the controller.
6. Each unit shall be constructed with single point electrical or pneumatic connection. All electrical components shall be ETL or UL listed or recognized and installed in accordance with the National Electrical Code. All electrical components shall be installed in a control box. The entire assembly shall be ETL listed and so labeled.
7. Each unit shall be internally lined with 3/4" (19) dual density fiberglass insulation. Edges shall be sealed against airflow erosion. Units shall meet NFPA 90A and UL 181 standards.
8. All sound data shall be compiled in an independent laboratory and in accordance with the latest version of AHRI Standard 880 and ANSI/ASHRAE Standard 130. All units shall be AHRI certified and bear the AHRI certification label.

OPTIONS

Electric Heat:

Model: 30RE Staged

(Substitute the following paragraphs:)

1. Furnish and install **Nailor Model 30RE Single Duct Variable Volume Terminal Units** of the sizes and capabilities as indicated on the drawings. Units shall be pressure independent with (DDC, analog electronic, pneumatic) controls. Units shall reset to any flow between minimum and the maximum cataloged airflow as allowed by the specific controller.
- 9. Single Duct Terminal Unit Staged Electric Heating Coils:**
 - a. Electric heating coils shall consist of open coils of high grade nickel and chromium resistance wire or nichrome elements and insulated with ceramic insulators in galvanized steel brackets, supported in heavy gauge galvanized steel frames. Each unit employing an electric heating coil shall be constructed and installed in accordance with the requirements of the local authorities and shall be UL or ETL listed specifically with the heater as a component of the terminal unit device.
 - b. Coils shall have the capacities indicated in Contract Documents. Coils rated up through 16.5 kW shall be single phase, 347 volt, 60 hertz and coils larger than 16.5 kW shall be three phase, four wire, 208, 480 or 600 volt, 60 hertz. Coils shall be available in one, two or three stages.
 - c. Terminal bolts, nuts and washers shall be of corrosion resistant materials. Coils shall be constructed so the installation may be accomplished in accordance with the provisions of the National Electrical Code, for zero clearance. Coils shall be given a 2000 volt dielectric test at the factory.
 - d. Automatic reset thermal cutouts shall be furnished for primary protection with manually resettable limit switches in power circuits for secondary protection. Both devices shall be serviceable through terminal box without removing heating element from the terminal device. The air pressure safety cutout pickup probe shall be remotely mounted near the volume control damper for maximum fidelity.
 - e. Heating coils shall have a terminal box and cover, with quiet type built-in magnetic step controlled contactors for each circuit, branch circuit fusing for each branch circuit on heaters over 48 amps per the NEC and an air flow safety interlock switch for installation in the heater control enclosure. Provide a 120 or 24 VAC control power transformer with an integral or separately mounted primary and/or secondary overcurrent protection device in accordance with NEC requirements.
 - f. All wiring of built-in devices shall be brought to clearly marked terminal strips. A complete wiring diagram shall be permanently attached to the heating coil panel cover.
 - g. Electric heating coils shall be designed for operation with the DDC controller and control system.
 - h. Electric heating coils and the associated control panels shall be constructed as a component of the entire terminal unit and mounted in the discharge attenuator downstream of the terminal unit. The resulting unit, including the heater and the VAV damper, shall be no longer than 37" (940) in length.
 - i. The manufacturer shall prove adequate even airflow over the electric heating coil under the full range of airflow scheduled (minimum to maximum) to prevent uneven heating of the electric coils. The terminal device shall be listed in accordance with UL 1995 as a composite assembly consisting of the VAV terminal device and the electric heating device.
 - j. Shop Drawings shall be submitted for review. Shop Drawings shall indicate specifically the exact construction, materials, internal wiring, NEC working clearances, etc., of the terminal units and electric heating coils to be furnished under these Specifications.

Single Duct Terminal Units • 3000 Series

Model 3001 • Basic Unit OPTIONS (continued)

Proportional Heat (SCR): (Substitute the following paragraphs:)

1. Furnish and install **Nailor Model 30RE Single Duct Variable Volume Terminal Units** of the sizes and capabilities as indicated on the drawings. Units shall be pressure independent with (DDC, analog electronic, pneumatic) controls. Units shall reset to any flow between minimum and the maximum cataloged airflow as allowed by the specific controller.

9. Single Duct Terminal Unit Proportional Electric Heating Coils:

a. Electric heating coils shall consist of open coils of high grade nickel and chromium resistance wire or nichrome elements and insulated with ceramic insulators in galvanized steel brackets, supported in heavy gauge galvanized steel frames. Each unit employing an electric heating coil shall be constructed and installed in accordance with the requirements of the local authorities and shall be UL or ETL listed specifically with the heater as a component of the terminal unit device.

b. Coils shall have the capacities indicated in Contract Documents. Coils rated up through 15.5 kW shall be single phase, 347 volt, 60 hertz and coils larger than 15.5 kW shall be three phase, four wire, 208, 480 or 600 volt, 60 hertz.

c. Terminal bolts, nuts and washers shall be of corrosion resistant materials. Coils shall be constructed so the installation may be accomplished in accordance with the provisions of the National Electrical Code, for zero clearance. Coils shall be given a 2000 volt dielectric test at the factory.

d. Automatic reset thermal cutouts shall be furnished for primary protection with manually resettable limit switches in power circuits for secondary protection. Both devices shall be serviceable through terminal box without removing heating element from the terminal device. The air pressure safety cutout pickup probe shall be remotely mounted near the volume control damper for maximum fidelity.

e. Heating coils shall have a terminal box and cover, with proportional heat control for the single circuit, branch circuit fusing on heaters over 45 amps per the NEC and an air flow safety interlock switch for installation in the heater control enclosure. Provide a 120 or 24 VAC control power transformer with an integral or separately mounted primary and/or secondary overcurrent protection device in accordance with NEC requirements.

f. An electric heater shall be factory mounted and pre-wired as an integral package with single duct variable volume terminal unit. Heaters shall be sized as shown on the drawings. The entire assembly including the electric heater shall be ETL listed for zero clearance and so labeled and shall meet all requirements of the latest National Electrical Code, (CSA C22.2 No.236). The unit shall have a single point electrical and/or pneumatic connection (dual point electrical on 600V). Heater casing and panel shall be a minimum of 20 ga. (1.00) galvanized steel. Each heater shall be complete with automatic reset high limit thermal cut-outs, control voltage transformer as required, ground terminal and high grade nickel chrome alloy wire.

Element wires shall be supported by ceramic isolators. Each heater shall be supplied with factory supplied and pre-wired branch circuit fusing as required by NEC and UL. Circuiting and fusing shall also be in accordance with the circuiting requirements as shown on the plans.

Additional accessories shall include (control transformer, circuit fusing, disconnect switch, pneumatic electric switches) for heater control.

Heater shall be capable of providing proportional control of heater capacity from an input signal of 4 – 20 mA, 2 – 10 VDC or 0 – 10 VDC. The SCR controller shall provide a 1 – 24 VDC pulsed output to SSR(s) [solid state relay(s)] in proportion to zone heating demand. The SSR's shall switch with zero cross over to reduce system noise and thermal shock on heater coils.

g. All wiring of built-in devices shall be brought to clearly marked terminal strips. A complete wiring diagram shall be permanently attached to the heating coil panel cover.

h. Electric heating coils shall be designed for operation with the DDC controller and control system.

i. Electric heating coils and the associated control panels shall be constructed as a component of the entire terminal unit and mounted in the discharge attenuator downstream of the terminal unit. The resulting unit, including the heater and the VAV damper, shall be no longer than 37" (940) in length.

j. The manufacturer shall prove adequate even airflow over the electric heating coil under the full range of airflow scheduled (minimum to maximum) to prevent uneven heating of the electric coils. The terminal device shall be listed in accordance with UL 1995 as a composite assembly consisting of the VAV terminal device and the electric heating device.

k. Shop Drawings shall be submitted for review. Shop Drawings shall indicate specifically the exact construction, materials, internal wiring, NEC working clearances, etc., of the terminal units and electric heating coils to be furnished under these Specifications.

Proportional Heat with Discharge Temperature Control (DTC): (Substitute the following paragraphs:)

1. Furnish and install **Nailor Model 30RE Single Duct Variable Volume Terminal Units** of the sizes and capabilities as indicated on the drawings. Units shall be pressure independent with (DDC, analog electronic, pneumatic) controls. Units shall reset to any flow between minimum and the maximum cataloged airflow as allowed by the specific controller.

9. Single Duct Terminal Unit Proportional Electric Heating Coils:

a. Electric heating coils shall consist of open coils of high grade nickel and chromium resistance wire or nichrome elements and insulated with ceramic insulators in galvanized steel brackets, supported in heavy gauge galvanized steel frames. Each unit employing an electric heating coil shall be constructed and installed in accordance with the requirements of the local authorities and shall be UL or ETL listed specifically with the heater as a component of the terminal unit device.

b. Coils shall have the capacities indicated in Contract Documents. Coils rated up through 15.5 kW shall be single phase, 347 volt, 60 hertz and coils larger than 15.5 kW shall be three phase, four wire, 208, 480 or 600 volt, 60 hertz.

c. Terminal bolts, nuts and washers shall be of corrosion resistant materials. Coils shall be constructed so the installation may be accomplished in accordance with the provisions of the National Electrical Code, for zero clearance. Coils shall be given a 2000 volt dielectric test at the factory.

d. Automatic reset thermal cutouts shall be furnished for primary protection with manually resettable limit switches in power circuits for secondary protection. Both devices shall be serviceable through terminal box without removing heating element from the terminal device. The air pressure safety cutout pickup probe shall be remotely mounted near the volume control damper for maximum fidelity.

e. Heating coils shall have a terminal box and cover, with proportional heat control for the single circuit, branch circuit fusing on heaters over 45 amps per the NEC and an air flow safety interlock switch for installation in the heater control enclosure. Provide a 120 or 24 VAC control power transformer with an integral or separately mounted primary and/or secondary overcurrent protection device in accordance with NEC requirements.

Single Duct Terminal Units • 3000 Series

Model 3001 • Basic Unit

OPTIONS (continued)

f. An electric heater shall be factory mounted and pre-wired as an integral package with the single duct variable volume terminal unit. Heaters shall be sized as shown on the drawings. The entire assembly including the electric heater shall be ETL listed for zero clearance and so labeled and shall meet all requirements of the latest National Electrical Code, (CSA C22.2 No.236). The unit shall have a single point electrical and/or pneumatic connection (dual point electrical on 600V). Heater casing and panel shall be a minimum of 20 ga. (1.00) galvanized steel. Each heater shall be complete with automatic reset high limit thermal cut-outs, control voltage transformer as required, ground terminal and high grade nickel chrome alloy wire.

Element wires shall be supported by ceramic isolators. Each heater shall be supplied with factory supplied and pre-wired branch circuit fusing as required by NEC and UL. Circuiting and fusing shall also be in accordance with the circuiting requirements as shown on the plans.

Additional accessories shall include (control transformer, circuit fusing, disconnect switch, pneumatic electric switches) for heater control.

Heater shall be capable of providing proportional control of heater capacity from an input signal of 4 – 20 mA, 2 – 10 VDC or 0 – 10 VDC. The SCR controller shall provide a 1 – 24 VDC pulsed output to SSR(s) [solid state relay(s)] in proportion to zone heating demand. The SSR's shall switch with zero cross over to reduce system noise and thermal shock on heater coils.

The SCR controller shall contain a discharge temperature sensor capable of limiting leaving air temperature to a user defined setpoint. The SCR controller shall pulse the coil to maintain zone demand while providing the set maximum discharge air temperature. Upon measuring a discharge air temperature above the user defined setpoint, the controller shall reduce heater capacity to maintain maximum allowable discharge air temperature. The discharge air temperature setpoint shall be adjustable from 80 – 120°F (27 – 49°C) by use of a controller mounted potentiometer.

g. All wiring of built-in devices shall be brought to clearly marked terminal strips. A complete wiring diagram shall be permanently attached to the heating coil panel cover.

h. Electric heating coils shall be designed for operation with the DDC controller and control system.

i. Electric heating coils and the associated control panels shall be constructed as a component of the entire terminal unit and mounted in the discharge attenuator downstream of the terminal unit. The resulting unit, including the heater and the VAV damper, shall be no longer than 37" (940) in length.

j. The manufacturer shall prove adequate even airflow over the electric heating coil under the full range of airflow scheduled (minimum to maximum) to prevent uneven heating of the electric coils. The terminal device shall be listed in accordance with UL 1995 as a composite assembly consisting of the VAV terminal device and the electric heating device.

k. Shop Drawings shall be submitted for review. Shop Drawings shall indicate specifically the exact construction, materials, internal wiring, NEC working clearances, etc., of the terminal units and electric heating coils to be furnished under these Specifications.

Hot Water Heating Coils:

Model: 30RW

(Substitute the following paragraphs:)

1. Furnish and install **Nailor Model 30RW Single Duct Variable Volume Terminal Units** of the sizes and capabilities as indicated on the drawings. Units shall be pressure independent with (DDC, analog electronic, pneumatic) controls. Units shall reset to any flow between minimum and the maximum cataloged airflow as allowed by the specific controller.

9. Single Duct Terminal Device Hot Water Heating Coils

a. Terminal unit hot water heating coils shall be mounted on the discharge of the unit with slip and drive connections. Provide an access door or panel on the bottom of the attenuator section of the terminal unit for servicing and cleaning the unit.

b. Hot water heating coils shall be constructed with copper tubes and aluminum plate fins. Coils shall have a maximum of 10 fins per inch. Supply and return connections shall be on the same end of the coil. Fins shall be bonded to the tubes by means of mechanical expansion of the tubes. Fins shall be at least .0045" (.11) thick.

c. Coils shall have galvanized steel casings on all sides no lighter than 20 ga. (1.00).

d. Tubes shall be ½" (13) O.D. and shall be spaced approximately 1 ¼" (32) apart and shall have a minimum wall thickness of 0.016" (.41). Hot water shall be equally distributed through all tubes by the use of orifices or header design. Water velocity in the tubes shall not exceed five feet per second. The water pressure drop through the coil shall not exceed 10 feet. Heating coil face velocities shall not exceed the maximum face velocity indicated in the schedules on the Contract Documents.

e. Coils shall be tested by air pressure under water. Coils shall be tested at 350 psi (2,413 kPa) air static pressure.

f. Coil ratings, calculations and selection data shall be in accordance with the applicable AHRI Standards and shall be submitted with the Shop Drawings.

Liner:

Steri-Liner

(Substitute the following paragraph:)

7. Each unit shall be fully lined with non-porous, sealed liner which complies with NFPA 90A & 90B, ASTM E84, UL 723, UL 181 and ASTM G21 & G22. Installation shall be 1/2" (13) minimum thickness, 4 lb./cu. ft. (64 kg/m³) density with reinforced aluminum foil-scrim-kraft (FSK) facing. All cut edges shall be secured with steel angles or end caps to encapsulate edges and prevent erosion. Insulation shall be Nailor Steri-Liner or equal.

Fiber-Free Liner

(Substitute the following paragraph:)

7. Each unit shall be fully lined with a non-porous closed cell elastomeric foam liner which complies with NFPA 90A & 90B, ASTM E84, UL 723 and UL 181. Installation shall be 3/8" (10) minimum thickness and secured to the interior of the terminal with mechanical fasteners. No fiberglass is permitted. Insulation shall be Nailor Fiber-Free Liner or equal.

Single Duct Terminal Units • 3000 Series

Model 3001 • Basic Unit

OPTIONS (continued)

EZvav Digital Controls

1.1 ASC VAV BACnet CONTROLLERS

A. Digital VAV Controllers shall be responsible for monitoring and controlling directly connected VAV Terminals as required. Controllers shall include fully adjustable analog outputs and digital outputs as required utilizing a proportional plus integral control loop to control damper, electric heat and hot water coils for the purpose of maintaining user setpoints. Each controller shall be classified as a native BACnet device, conforming to the BACnet Advanced Specific Controllers (B-ASC) profile, ANSI/ASHRAE BACnet Standard 135.

B. The VAV controller shall be available with integrated applications (based on model) for Single Duct, Dual Duct, and Fan Powered terminal units, including any of the following as required by the control sequence. For Single/Dual Duct terminals: Cooling Only, Cooling/Heating with Changeover and Morning Warm up. For Fan Powered terminals: Cooling with Reheat/Supplementary Heat, Heating coil operation may be with analog, floating or binary control as required.

C. The controller shall be fully configurable via the Digital Display Sensor, including communication parameters (instance, MAC, baud) and application settings (K-factor, flow limits, box configuration, reheat or fan type, default user setpoints, etc.), without any specific PC-based software. VAV controllers shall not require the use of a personal computer and PC based software and/or any interface modules.

D. The VAV controller shall be capable of being balanced from the Digital Room Sensor without any specific pc-based software.

E. The controller shall have integrated MS/TP communications. The communication port shall have network protection bulbs and integrated end-of-line (EOL) terminations.

F. The controller shall have an integrated actuator rated at 40 in-lbs. Connection to the damper shall be with a v-bolt clamp, accepting 3/8" to 5/8" damper shaft sizes. The actuator shall travel 0 to 95 degrees with adjustable end stops at 45 and 60 degrees of rotation. The actuator shall have an integrated gear disengagement mechanism.

G. The controller shall have an integrated transducer pressure sensor for airflow measurement. The sensor shall have a range of 0-2"wc, consuming and accurate to 4.5% of reading or 0.0008"wc, whichever is greater.

H. The controller shall have a Dedicated Room Sensor port for direct interface to a Digital Display Room Sensor or Discrete Room Sensor. The controller shall have the ability of detecting if a sensor has been connected to the port and identify its type, either digital display or discrete. Sensors shall be hot-swappable without powering down the controller. Sensor information via the ports shall not consume any of the devices terminated input capacity.

I. The controller shall have screw terminal blocks that can accommodate wire sizes 14-22 AWG. Terminals shall be color coded: black terminals for power, green terminals for input and outputs, and grey terminals for twisted-shielded-pair communication.

J. The power supply for the controller shall be 24 volts AC (-15%, +20%) power. Voltage below the operating range of the system shall be considered an outage.

1.2 DIGITAL ROOM SENSOR

A. The Digital Display Room Sensor (thermostat) shall provide space condition measurements and indications, including temperature and local motion/occupancy (optional), and user setpoint adjustments.

B. The Digital Room Sensor shall connect directly to the controller and shall not utilize any of the hardware I/O points of the controller. The Digital Display Room Sensor shall be able to be located up to 75' from the controller.

C. The Digital Display Room Sensor shall provide a Temporary Network Interface jack, field accessible without uninstalling the sensor, for connection to the BACnet MS/TP communication trunk to which the devices connected. The Digital Display Room Sensor, the connected controller, and all other devices on the BACnet network shall be accessible through the temporary communication jack. Microprocessor based sensors whose port only allows communication with the controller to which it is connected shall not be acceptable.

D. The Digital Display Room Sensor shall have an integrated sensor for temperature measurement as standard and a second integrated sensor for motion/occupancy (optional).

E. User/Occupant setpoints may be adjusted via the Digital Display Room Sensor.

F. The Digital Display Room Sensor shall have pre-configured menus for all control sequences allowing access to communication and application parameters.

G. The Digital Display Room Sensor shall have two levels of password protection: One level to protect user setpoint adjustment, and one level to protect configuration menu parameters. Passwords shall be at least 4 digits in length.

Model 3001Q • Quiet Unit

1. Furnish and install **Nailor 3000Q Series Single Duct Variable Volume Quiet Terminal Units** of the sizes and capabilities as indicated on the drawings. Unit shall be pressure independent with (DDC, analog electronic, pneumatic) controls. Unit shall reset to any flow between minimum and the maximum cataloged airflow as allowed by the specific controller.

2. The entire quiet terminal unit shall be designed and built as a single unit. The unit shall be provided with a primary variable air volume damper that controls the air quantity in response to a (DDC, electric, analog electronic or pneumatic) thermostat. The unit shall have a factory installed dissipative silencer and include all options such as electric or hot water heating coils and access doors. The space limitations shall be reviewed carefully to insure that all units will fit into the space allowed.

3. Unit casing shall be 22 ga. (.86) galvanized steel with round, flat oval or rectangular inlets with 5 1/2" (140) deep inlet duct collar for field connection. Outlets shall be rectangular and configured for slip and drive connections. Casing leakage downstream of the damper shall not exceed 1% @ 1" w.g. (250 Pa). High side casing leakage shall not exceed 2% @ 3" w.g. (746 Pa).

4. Damper assemblies of 16 ga. (1.63) galvanized steel shall be multiple opposed blade construction arranged to close at 45 degrees from full open to minimize air turbulence and provide near linear operation. Damper blades shall be fitted with flexible seals for tight closure and minimized sound generation. Damper blades shall be screwed through the shaft to insure that no slippage occurs. Blade shafts shall pivot in corrosion free self-lubricating bronze oilite bearings. In the fully closed position, air leakage past the closed damper shall not exceed 2% of the nominal catalog rating at 3" w.g. (746 Pa) inlet static pressure as rated by ASHRAE Standard 130.

5. The terminal units shall be capable of operation as described herein with a minimum inlet static pressure that shall not exceed 0.30" w.g. (75 Pa) @ 2000 fpm (10.2 m/s) inlet velocity. (The sequence of operations should be described here, if not part of the temperature controls specifications.) Each unit shall be complete with factory mounted (DDC, electric, analog electronic or pneumatic) controls. Gauge tap ports shall be supplied in the piping between the flow pick up and the controller.

6. Each unit shall be constructed with single point electrical (and pneumatic) connections. All electrical components shall be ETL or UL listed or recognized and installed in accordance with the National Electrical Code. All electrical components shall be installed in a control box. The entire assembly shall be ETL listed and so labeled.

Single Duct Terminal Units • 3000Q Series

7. Each VAV section unit shall be internally lined with ¾" (19) dual density fiberglass insulation. Edges shall be sealed against airflow erosion. Units shall meet NFPA 90A and UL 181 standards.
8. All sound data shall be compiled in an independent laboratory and in accordance with the latest version of AHRI Standard 880 and ANSI/ASHRAE Standard 130.
9. Dissipative silencers shall contain a unit casing constructed of 22 ga. (.86) galvanized steel. Inlet and discharge shall be rectangular and configured for slip and drive connections. Each silencer shall be lined with fiberglass insulation, placed inside the top and bottom sides of the silencer, thereby eliminating the requirement for field wrapping with thermal insulation. The silencer baffles shall be filled with fiberglass absorption media and encapsulated by 22 ga. (.86) perforated coated steel baffles. The perforated metal baffles shall be rigidly fastened to the casing of the silencer. Units shall meet NFPA 90A and UL 181 standards.

- g. Electric heating coils shall be designed for operation with the DDC controller and control system.
- h. Electric heating coils and the associated control panels shall be constructed as a component of the entire terminal unit and mounted in the discharge attenuator downstream of the terminal unit. The resulting unit, including the heater, the VAV damper and the dissipative silencer shall be no longer than 79" (2007) in length.
- i. The manufacturer shall prove adequate even airflow over the electric heating coil under the full range of airflow scheduled (minimum to maximum) to prevent uneven heating of the electric coils. The terminal device shall be listed in accordance with UL 1995 as a composite assembly consisting of the VAV terminal device and the electric heating device.
- j. Shop Drawings shall be submitted for review. Shop Drawings shall indicate specifically the exact construction, materials, internal wiring, NEC working clearances, etc., of the terminal units and electric heating coils to be furnished under these Specifications.

OPTIONS

Electric Heat:

Model: 30REQ

Staged

(Substitute the following paragraphs:)

1. Furnish and install **Nailor Model 30REQ Single Duct Variable Volume Quiet Terminal Units** of the sizes and capabilities as indicated on the drawings. Unit shall be pressure independent with (DDC, analog electronic, pneumatic) controls. Unit shall reset to any flow between minimum and the maximum cataloged airflow as allowed by the specific controller.
10. **Single Duct Quiet Terminal Unit Staged Electric Heating Coils:**
 - a. Electric heating coils shall consist of open coils of high grade nickel and chromium resistance wire or nichrome elements and insulated with ceramic insulators in galvanized steel brackets, supported in heavy gauge galvanized steel frames. Each unit employing an electric heating coil shall be constructed and installed in accordance with the requirements of the local authorities and shall be UL or ETL listed specifically with the heater as a component of the terminal unit device.
 - b. Coils shall have the capacities indicated in Contract Documents. Coils rated up through 16.5 kW shall be single phase, 347 volt, 60 hertz and coils larger than 16.5 kW shall be three phase, four wire, 208, 480 or 600 volt, 60 hertz. Coils shall be available in one, two or three stages.
 - c. Terminal bolts, nuts and washers shall be of corrosion resistant materials. Coils shall be constructed so the installation may be accomplished in accordance with the provisions of the National Electrical Code, for zero clearance. Coils shall be given a 2000 volt dielectric test at the factory.
 - d. Automatic reset thermal cutouts shall be furnished for primary protection with manually resettable limit switches in power circuits for secondary protection. Both devices shall be serviceable through terminal box without removing heating element from the terminal device. The air pressure safety cutout pickup probe shall be remotely mounted near the volume control damper for maximum fidelity.
 - e. Heating coils shall have a terminal box and cover, with quiet type built-in magnetic step controlled contactors for each circuit, branch circuit fusing for each branch circuit on heaters over 48 amps per the NEC and an air flow safety interlock switch for installation in the heater control enclosure. Provide a 120 or 24 VAC control power transformer with an integral or separately mounted primary and/or secondary overcurrent protection device in accordance with NEC requirements.
 - f. All wiring of built-in devices shall be brought to clearly marked terminal strips. A complete wiring diagram shall be permanently attached to the heating coil panel cover.

Proportional Heat (SCR):

(Substitute the following paragraphs:)

1. Furnish and install **Nailor Model 30REQ Single Duct Variable Volume Quiet Terminal Units** of the sizes and capabilities as indicated on the drawings. Unit shall be pressure independent with (DDC, analog electronic, pneumatic) controls. Unit shall reset to any flow between minimum and the maximum cataloged airflow as allowed by the specific controller.
- b. Coils shall have the capacities indicated in Contract Documents. Coils rated up through 15.5 kW shall be single phase, 347 volt, 60 hertz and coils larger than 15.5 kW shall be three phase, four wire, 208, 480 or 600 volt, 60 hertz.
- c. Terminal bolts, nuts and washers shall be of corrosion resistant materials. Coils shall be constructed so the installation may be accomplished in accordance with the provisions of the National Electrical Code, for zero clearance. Coils shall be given a 2000 volt dielectric test at the factory.
- d. Automatic reset thermal cutouts shall be furnished for primary protection with manually resettable limit switches in power circuits for secondary protection. Both devices shall be serviceable through terminal box without removing heating element from the terminal device. The air pressure safety cutout pickup probe shall be remotely mounted near the volume control damper for maximum fidelity.
- e. Heating coils shall have a terminal box and cover, with quiet type built-in magnetic step controlled contactors for each circuit, branch circuit fusing for each branch circuit on heaters over 45 amps per the NEC and an air flow safety interlock switch for installation in the heater control enclosure. Provide a 120 or 24 VAC control power transformer with an integral or separately mounted primary and/or secondary overcurrent protection device in accordance with NEC requirements.
10. **Single Duct VAV Quiet Terminal Unit Staged Electric Heating Coils:**
 - a. Electric heating coils shall consist of open coils of high grade nickel and chromium resistance wire or nichrome elements and insulated with ceramic insulators in galvanized steel brackets, supported in heavy gauge galvanized steel frames. Each unit employing an electric heating coil shall be constructed and installed in accordance with the requirements of the local authorities and shall be UL or ETL listed specifically with the heater as a component of the terminal unit device.
 - f. An electric heater shall be factory mounted and pre-wired as an integral package with the fan powered terminal unit. Heaters shall be sized as shown on the drawings. The entire assembly including the electric heater shall be ETL listed for zero clearance and so labeled and shall meet all requirements of the latest National Electrical Code, (CSA C22.2 No.236). The unit shall have a single point electrical and/or pneumatic connection (dual point electrical on 600V). Heater casing

Single Duct Terminal Units • 3000Q Series

Model 3001Q • Quiet Unit OPTIONS (continued)

and panel shall be a minimum of 20 ga. (1.00) galvanized steel. Each heater shall be complete with automatic reset high limit thermal cut-outs, control voltage transformer as required, ground terminal, fan relay for interlocking the heater and fan and high grade nickel chrome alloy wire. Element wires shall be supported by ceramic isolators. Each heater shall be supplied with factory supplied and pre-wired branch circuit fusing as required by NEC and UL. Circuiting and fusing shall also be in accordance with the circuiting requirements as shown on the plans.

Additional accessories shall include (control transformer, circuit fusing, disconnect switch, pneumatic electric switches) for heater control. Heater shall be capable of providing proportional control of heater capacity from an input signal of 4 – 20 mA, 2 – 10 VDC or 0 – 10 VDC. The SCR controller shall provide a 1 – 24 VDC pulsed output to SSR(s) [solid state relay(s)] in proportion to zone heating demand. The SSR's shall switch with zero cross over to reduce system noise and thermal shock on heater coils.

g. Electric heating coils shall be designed for operation with the DDC controller and control system.

h. Electric heating coils and the associated control panels shall be constructed as a component of the entire terminal unit and mounted in the discharge attenuator downstream of the terminal unit. The resulting unit, including the heater, the VAV damper and the dissipative silencer shall be no longer than 79" (2007) in length.

i. The manufacturer shall prove adequate even airflow over the electric heating coil under the full range of airflow scheduled (minimum to maximum) to prevent uneven heating of the electric coils. The terminal device shall be listed in accordance with UL 1995 as a composite assembly consisting of the VAV terminal device and the electric heating device.

j. Shop Drawings shall be submitted for review. Shop Drawings shall indicate specifically the exact construction, materials, internal wiring, NEC working clearances, etc., of the terminal units and electric heating coils to be furnished under these Specifications.

Proportional Heat with Discharge Temperature Control (DTC):

(Substitute the following paragraphs:)

1. Furnish and install **Nailor Model 30REQ Single Duct Variable Volume Quiet Terminal Units** of the sizes and capabilities as indicated on the drawings. Unit shall be pressure independent with (DDC, analog electronic, pneumatic) controls. Unit shall reset to any flow between minimum and the maximum cataloged airflow as allowed by the specific controller.

10. Single Duct Quiet Terminal Unit Staged Electric Heating Coils:

a. Electric heating coils shall consist of open coils of high grade nickel and chromium resistance wire or nichrome elements and insulated with ceramic insulators in galvanized steel brackets, supported in heavy gauge galvanized steel frames. Each unit employing an electric heating coil shall be constructed and installed in accordance with the requirements of the local authorities and shall be UL or ETL listed specifically with the heater as a component of the terminal unit device.

b. Coils shall have the capacities indicated in Contract Documents. Coils rated up through 15.5 kW shall be single phase, 347 volt, 60 hertz and coils larger than 15.5 kW shall be three phase, four wire, 208, 480 or 600 volt, 60 hertz.

c. Terminal bolts, nuts and washers shall be of corrosion resistant materials. Coils shall be constructed so the installation may be accomplished in accordance with the provisions of the National Electrical Code, for zero clearance. Coils shall be given a 2000 volt dielectric test at the factory.

d. Automatic reset thermal cutouts shall be furnished for primary protection with manually resettable limit switches in power circuits for secondary protection. Both devices shall be serviceable through terminal box without removing heating element from the terminal device. The air pressure safety cutout pickup probe shall be remotely mounted near the volume control damper for maximum fidelity.

e. Heating coils shall have a terminal box and cover, with quiet type built-in magnetic step controlled contactors for each circuit, branch circuit fusing for each branch circuit on heaters over 45 amps per the NEC and an air flow safety interlock switch for installation in the heater control enclosure. Provide a 120 or 24 VAC control power transformer with an integral or separately mounted primary and/or secondary overcurrent protection device in accordance with NEC requirements.

f. All wiring of built-in devices shall be brought to clearly marked terminal strips. A complete wiring diagram shall be permanently attached to the heating coil panel cover.

The SCR controller shall contain a discharge temperature sensor capable of limiting leaving air temperature to a user defined setpoint. The SCR controller shall pulse the coil to maintain zone demand while providing the set maximum discharge air temperature. Upon measuring a discharge air temperature above the user defined setpoint, the controller shall reduce heater capacity to maintain maximum allowable discharge air temperature. The discharge air temperature setpoint shall be adjustable from 80–100°F (27–149°C) by use of a controller mounted potentiometer.

g. Electric heating coils shall be designed for operation with the DDC controller and control system.

h. Electric heating coils and the associated control panels shall be constructed as a component of the entire terminal unit and mounted in the discharge attenuator downstream of the terminal unit. The resulting unit, including the heater, the VAV damper and the dissipative silencer shall be no longer than 79" (2007) in length.

i. The manufacturer shall prove adequate even airflow over the electric heating coil under the full range of airflow scheduled (minimum to maximum) to prevent uneven heating of the electric coils. The terminal device shall be listed in accordance with UL 1995 as a composite assembly consisting of the VAV terminal device and the electric heating device.

j. Shop Drawings shall be submitted for review. Shop Drawings shall indicate specifically the exact construction, materials, internal wiring, NEC working clearances, etc., of the terminal units and electric heating coils to be furnished under these Specifications.

Hot Water Heating Coils:

Model: 30RWQ

(Substitute the following paragraphs:)

10. Single Duct Quiet Terminal Device Hot Water Heating Coils

a. Terminal unit hot water heating coils shall be mounted on the discharge of the unit with slip and drive connections. Provide an access door or panel on the bottom of the silencer section of the terminal unit for servicing and cleaning the unit.

b. Hot water heating coils shall be constructed with copper tubes and aluminum plate fins. Coils shall have a maximum of 10 fins per inch. Supply and return connections shall be on the same end of the coil. Fins shall be bonded to the tubes by means of mechanical expansion of the tubes. Fins shall be at least .0045" (.11) thick.

c. Coils shall have galvanized steel casings on all sides no lighter than 20 ga. (1.00).

d. Tubes shall be ½" (13) O.D. and shall be spaced approximately 1 ¼" (32) apart and shall have a minimum wall thickness of 0.016" (.41). Hot water shall be equally distributed through all tubes by the use of header. Water velocity in the tubes shall not exceed five feet per second. The water pressure drop through the coil shall not exceed 10 feet. Heating coil face velocities shall not exceed the maximum face velocity indicated in the schedules on the Contract Documents.

Single Duct Terminal Units • 3000Q Series

Model 3001Q • Quiet Unit

OPTIONS (continued)

- e. Coils shall be tested by air pressure under water. Coils shall be tested at 350 psi (2,413 kPa) air static pressure.
- f. Control valves automatic vents and drains, if needed, shall be supplied and field installed by others.
- g. Coil ratings, calculations and selection data shall be in accordance with the applicable AHRI Standards and shall be submitted with the Shop Drawings.

Liner:

Steri-Liner

(Substitute the following paragraph:)

3. Unit casings shall be 20 ga. (1.00) galvanized steel. Unit shall be fully lined with non-porous, sealed liner which complies with NFPA 90A & 90B, ASTM E84, UL 723, UL 181 and ASTM G21 & G22. Installation shall be 1/2" (13) minimum thickness, 4 lb./cu. ft. (64 kg/m³) density with reinforced aluminum foil-scrim-kraft (FSK) facing. All cut edges shall be secured with steel angles or end caps to encapsulate edges and prevent erosion. Insulation shall be Nailor Steri-Liner or equal.

Fiber-Free Liner

(Substitute the following paragraph:)

3. Unit casings shall be 20 ga. (1.00) galvanized steel. Unit shall be fully lined with a non-porous closed cell elastomeric foam liner which complies with NFPA 90A & 90B, ASTM E84, UL 723 & UL 181. Installation shall be 3/8" (10) minimum thickness and secured to the interior of the terminal with mechanical fasteners. No fiberglass is permitted. Insulation shall be Nailor Fiber-Free Liner or equal.

EZvav Digital Controls

1.1 ASC VAV BACnet CONTROLLERS

- A. Digital VAV Controllers shall be responsible for monitoring and controlling directly connected VAV Terminals as required. Controllers shall include fully adjustable analog outputs and digital outputs as required utilizing a proportional plus integral control loop to control damper, electric heat and hot water coils for the purpose of maintaining user setpoints. Each controller shall be classified as a native BACnet device, conforming to the BACnet Advanced Specific Controllers (B-ASC) profile, ANSI/ASHRAE BACnet Standard 135.
- B. The VAV controller shall be available with integrated applications (based on model) for Single Duct, Dual Duct, and Fan Powered terminal units, including any of the following as required by the control sequence. For Single/Dual Duct terminals: Cooling Only, Cooling/Heating with Changeover and Morning Warm up. For Fan Powered terminals: Cooling with Reheat/Supplementary Heat, Heating coil operation may be with analog, floating or binary control as required.
- C. The controller shall be fully configurable via the Digital Display Sensor, including communication parameters (instance, MAC, baud) and application settings (K-factor, flow limits, box configuration, reheat or fan type, default user setpoints, etc.), without any specific PC-based software. VAV controllers shall not require the use of a personal computer and PC based software and/or any interface modules.
- D. The VAV controller shall be capable of being balanced from the Digital Room Sensor without any specific pc-based software.
- E. The controller shall have integrated MS/TP communications. The communication port shall have network protection bulbs and integrated end-of-line (EOL) terminations.

F. The controller shall have an integrated actuator rated at 40 in-lbs. Connection to the damper shall be with a v-bolt clamp, accepting 3/8(B-ASC)" to 5/8(B-ASC)" damper shaft sizes. The actuator shall travel 0 to 95 degrees with adjustable end stops at 45 and 60 degrees of rotation. The actuator shall have an integrated gear disengagement mechanism.

G. The controller shall have an integrated transducer pressure sensor for airflow measurement. The sensor shall have a range or 0-2(B-ASC)"wc, consuming and accurate to 4.5% of reading or 0.0008(B-ASC)"wc, whichever is greater.

H. The controller shall have a Dedicated Room Sensor port for direct interface to a Digital Display Room Sensor or Discrete Room Sensor. The controller shall have the ability of detecting if a sensor has been connected to the port and identify its type, either digital display or discrete. Sensors shall be hot-swappable without powering down the controller. Sensor information via the ports shall not consume any of the devices terminated input capacity.

I. The controller shall have screw terminal blocks that can accommodate wire sizes 14-22 AWG. Terminals shall be color coded: black terminals for power, green terminals for input and outputs, and grey terminals for twisted-shielded-pair communication.

J. The power supply for the controller shall be 24 volts AC (-15%, +20%) power. Voltage below the operating range of the system shall be considered an outage.

1.2 DIGITAL ROOM SENSOR

A. The Digital Display Room Sensor (thermostat) shall provide space condition measurements and indications, including temperature and local motion/occupancy (optional), and user setpoint adjustments.

B. The Digital Room Sensor shall connect directly to the controller and shall not utilize any of the hardware I/O points of the controller. The Digital Display Room Sensor shall be able to be located up to 75' from the controller.

C. The Digital Display Room Sensor shall provide a Temporary Network Interface jack, field accessible without uninstalling the sensor, for connection to the BACnet MS/TP communication trunk to which the devices connected. The Digital Display Room Sensor, the connected controller, and all other devices on the BACnet network shall be accessible through the temporary communication jack. Microprocessor based sensors whose port only allows communication with the controller to which it is connected shall not be acceptable.

D. The Digital Display Room Sensor shall have an integrated sensor for temperature measurement as standard and a second integrated sensor for motion/occupancy (optional).

E. User/Occupant setpoints may be adjusted via the Digital Display Room Sensor.

F. The Digital Display Room Sensor shall have pre-configured menus for all control sequences allowing access to communication and application parameters.

G. The Digital Display Room Sensor shall have two levels of password protection: One level to protect user setpoint adjustment, and one level to protect configuration menu parameters. Passwords shall be at least 4 digits in length.

Single Duct Terminal Units • 30HQ Series

Model 30HQ • Hospital Grade Unit

1. Furnish and install **Nailor 30HQ Series Single Duct Variable Volume Hospital Grade Terminal Units** of the sizes and capabilities as indicated on the drawings. Units shall be pressure independent with (DDC, analog electronic, pneumatic) controls. Units shall reset to any flow between minimum and the maximum cataloged airflow as allowed by the specific controller.

2. The entire hospital grade terminal unit shall be designed and built as a single unit. The unit shall be provided with a primary variable air volume damper that controls the air quantity in response to a (DDC, electric, analog electronic or pneumatic) thermostat. The unit shall include a factory installed dissipative silencer and include all options such as electric or hot water heating coils and access doors. The space limitations shall be reviewed carefully to insure that all units will fit into the space allowed.

3. Unit casing shall be 22 ga. (0.86) galvanized steel with round or flat oval inlets with 5 1/2" (140) deep inlet duct collar for field connection. Outlets shall be rectangular and configured for slip and drive connections. Casing leakage downstream of the damper shall not exceed 1% @ 1" w.g. (250 Pa). High side casing leakage shall not exceed 2% @ 3" w.g. (746 Pa).

4. Damper assemblies of 16 ga. (1.63) galvanized steel shall be multiple opposed blade construction arranged to close at 45 degrees from full open to minimize air turbulence and provide near linear operation. Damper blades shall be fitted with flexible seals for tight closure and minimized sound generation. Damper blades shall be screwed through the shaft to insure that no slippage occurs. Blade shafts shall pivot in corrosion free self-lubricating bronze oilite bearings. In the fully closed position, air leakage past the closed damper shall not exceed 2% of the nominal catalog rating at 3" w.g. (746 Pa) inlet static pressure as rated by ASHRAE Standard 130.

5. The terminal units shall be capable of operation as described herein with a minimum inlet static pressure that shall not exceed 0.28" w.g. (70 Pa) @ 2000 fpm (10.2 m/s) inlet velocity. (The sequence of operations should be described here, if not part of the temperature controls specifications.) Each unit shall be complete with factory mounted (DDC, electric, analog electronic or pneumatic) controls. Gauge tap ports shall be supplied in the piping between the flow pick up and the controller.

6. Each unit shall be constructed with single point electrical (and pneumatic) connections. All electrical components shall be ETL or UL listed or recognized and installed in accordance with the National Electrical Code. All electrical components shall be installed in a control box. The entire assembly shall be ETL listed and so labeled.

7. Each VAV section shall be internally lined with 13/16" (21) thick, 4 lb. /cu. ft. (64 Kg/m³) density fiberglass insulation with a reinforced aluminum FSK facing. Units shall meet NFPA 90A and UL 181 standards.

8. All sound data shall be compiled in an independent laboratory and in accordance with the latest version of AHRI Standard 880 and ANSI/ASHRAE Standard 130. All units shall be AHRI certified and bear the AHRI certification label.

9. Dissipative silencer sections shall contain a unit casing constructed of 22 ga. (.86) galvanized steel. Inlet and discharge shall be rectangular and configured for slip and drive connections. Each silencer shall be internally lined with 13/16" (21) thick, 4 lb. density fiberglass insulation with a reinforced aluminum FSK facing, placed inside the top and bottom sides of the silencer, thereby eliminating the requirement for field wrapping with thermal insulation. The silencer baffles shall be filled with fiberglass acoustical absorption media and encapsulated by 22 ga. (.86) perforated coated steel baffles. A mylar liner shall separate the fiberglass from the perforated metal baffle, with an acoustical spacer and isolate the fiberglass from the airstream. The perforated metal baffles shall be rigidly fastened to the casing of the silencer. Units shall meet NFPA 90A and UL 181 standards.

OPTIONS

Electric Heat:

Model: 30HQE

Staged

(Substitute the following paragraphs:)

1. Furnish and install **Nailor Model 30HQE Single Duct Variable Volume Hospital Grade Terminal Units** of the sizes and capabilities as indicated on the drawings. Unit shall be pressure independent with (DDC, analog electronic, pneumatic) controls. Unit shall reset to any flow between minimum and the maximum cataloged airflow as allowed by the specific controller.

10. Single Duct Hospital Grade Terminal Unit Staged Electric Heating Coils:

a. Electric heating coils shall consist of open coils of high grade nickel and chromium resistance wire or nichrome elements and insulated with ceramic insulators in galvanized steel brackets, supported in heavy gauge galvanized steel frames. Each unit employing an electric heating coil shall be constructed and installed in accordance with the requirements of the local authorities and shall be UL or ETL listed specifically with the heater as a component of the terminal unit device.

b. Coils shall have the capacities indicated in Contract Documents. Coils rated up through 16.5 kW shall be single phase, 347 volt, 60 hertz and coils larger than 16.5 kW shall be three phase, four wire, 208, 480 or 600 volt, 60 hertz. Coil shall be available in one, two or three stages.

c. Terminal bolts, nuts and washers shall be of corrosion resistant materials. Coils shall be constructed so the installation may be accomplished in accordance with the provisions of the National Electrical Code, for zero clearance. Coils shall be given a 2000 volt dielectric test at the factory.

d. Automatic reset thermal cutouts shall be furnished for primary protection with manually resettable limit switches in power circuits for secondary protection. Both devices shall be serviceable through terminal box without removing heating element from the terminal device. The air pressure safety cutout pickup probe shall be remotely mounted near the volume control damper for maximum fidelity.

e. Heating coils shall have a terminal box and cover, with quiet type built-in magnetic step controlled contactors for each circuit, branch circuit fusing for each branch circuit on heaters over 48 amps per the NEC and an air flow safety interlock switch for installation in the heater control enclosure. Provide a 120 or 24 VAC control power transformer with an integral or separately mounted primary and/or secondary overcurrent protection device in accordance with NEC requirements.

f. All wiring of built-in devices shall be brought to clearly marked terminal strips. A complete wiring diagram shall be permanently attached to the heating coil panel cover.

g. Electric heating coils shall be designed for operation with the DDC controller and control system.

h. Electric heating coils and the associated control panels shall be constructed as a component of the entire terminal unit and mounted in the discharge attenuator downstream of the terminal unit. The resulting unit, including the heater, the VAV damper and the dissipative silencer shall be no longer than 79" (2007) in length.

i. The manufacturer shall prove adequate even airflow over the electric heating coil under the full range of airflow scheduled (minimum to maximum) to prevent uneven heating of the electric coils. The terminal device shall be listed in accordance with UL 1995 as a composite assembly consisting of the VAV terminal device and the electric heating device.

j. Shop Drawings shall be submitted for review. Drawings shall indicate specifically the exact construction, materials, internal wiring, NEC working clearances, etc., of the terminal units and electric heating coils to be furnished under these Specifications.

Single Duct Terminal Units • 30HQ Series

Model 30HQ • Hospital Grade Unit

OPTIONS (continued)

Proportional Heat (SCR)

(Substitute the following paragraphs:)

1. Furnish and install **Nailor Model 30HQE Single Duct Variable Volume Hospital Grade Terminal Units** of the sizes and capabilities as indicated on the drawings. Unit shall be pressure independent with (DDC, analog electronic, pneumatic) controls. Unit shall reset to any flow between minimum and the maximum cataloged airflow as allowed by the specific controller.

10. Single Duct Hospital Grade Terminal Unit Staged Electric Heating Coils:

a. Electric heating coils shall consist of open coils of high grade nickel and chromium resistance wire or nichrome elements and insulated with ceramic insulators in galvanized steel brackets, supported in heavy gauge galvanized steel frames. Each unit employing an electric heating coil shall be constructed and installed in accordance with the requirements of the local authorities and shall be UL or ETL listed specifically with the heater as a component of the terminal unit device.

b. Coils shall have the capacities indicated in Contract Documents. Coils rated up through 15.5 kW shall be single phase, 347 volt, 60 hertz and coils larger than 15.5 kW shall be three phase, four wire, 207, 480 or 600 volt, 60 hertz.

c. Terminal bolts, nuts and washers shall be of corrosion resistant materials. Coils shall be constructed so the installation may be accomplished in accordance with the provisions of the National Electrical Code, for zero clearance. Coils shall be given a 2000 volt dielectric test at the factory.

d. Automatic reset thermal cutouts shall be furnished for primary protection with manually resettable limit switches in power circuits for secondary protection. Both devices shall be serviceable through terminal box without removing heating element from the terminal device. The air pressure safety cutout pickup probe shall be remotely mounted near the volume control damper for maximum fidelity.

e. Heating coils shall have a terminal box and cover, with quiet type built-in magnetic step controlled contactors for each circuit, branch circuit fusing for each branch circuit on heaters over 45 amps per the NEC and an air flow safety interlock switch for installation in the heater control enclosure. Provide a 120 or 24 VAC control power transformer with an integral or separately mounted primary and/or secondary overcurrent protection device in accordance with NEC requirements.

f. All wiring of built-in devices shall be brought to clearly marked terminal strips. A complete wiring diagram shall be permanently attached to the heating coil panel cover.

g. Electric heating coils shall be designed for operation with the DDC controller and control system.

f. An electric heater shall be factory mounted and pre-wired as an integral package with the fan powered terminal unit. Heaters shall be sized as shown on the drawings. The entire assembly including the electric heater shall be ETL listed for zero clearance and so labeled and shall meet all requirements of the latest National Electrical Code, (CSA C22.2 No.236). The unit shall have a single point electrical and/or pneumatic connection (dual point electrical on 600V). Heater casing and panel shall be a minimum of 20 ga. (1.00) galvanized steel. Each heater shall be complete with automatic reset high limit thermal cut-outs, control voltage transformer as required, ground terminal, fan relay for interlocking the heater and fan and high grade nickel chrome alloy wire.

Element wires shall be supported by ceramic isolators. Each heater shall be supplied with factory supplied and pre-wired branch circuit fusing as required by NEC and UL. Circuiting and fusing shall also be in accordance with the circuiting requirements as shown on the plans.

Additional accessories shall include (control transformer, circuit fusing,

disconnect switch, pneumatic electric switches) for heater control. Heater shall be capable of providing proportional control of heater capacity from an input signal of 4 – 20 mA, 2 – 10 VDC or 0 – 10 VDC. The SCR controller shall provide a 1 – 24 VDC pulsed output to SSR(s) [solid state relay(s)] in proportion to zone heating demand. The SSR's shall switch with zero cross over to reduce system noise and thermal shock on heater coils.

h. Electric heating coils and the associated control panels shall be constructed as a component of the entire terminal unit and mounted in the discharge attenuator downstream of the terminal unit. The resulting unit, including the heater, the VAV damper and the dissipative silencer shall be no longer than 79" (2007) in length.

i. The manufacturer shall prove adequate even airflow over the electric heating coil under the full range of airflow scheduled (minimum to maximum) to prevent uneven heating of the electric coils. The terminal device shall be listed in accordance with UL 1995 as a composite assembly consisting of the VAV terminal device and the electric heating device.

j. Shop Drawings shall be submitted for review. Drawings shall indicate specifically the exact construction, materials, internal wiring, NEC working clearances, etc., of the terminal units and electric heating coils to be furnished under these Specifications.

Proportional Heat with Discharge Temperature Control (DTC)

(Substitute the following paragraphs:)

1. Furnish and install **Nailor Model 30HQE Single Duct Variable Volume Hospital Grade Terminal Units** of the sizes and capabilities as indicated on the drawings. Unit shall be pressure independent with (DDC, analog electronic, pneumatic) controls. Unit shall reset to any flow between minimum and the maximum cataloged airflow as allowed by the specific controller.

10. Single Duct Hospital Grade Terminal Unit Staged Electric Heating Coils:

a. Electric heating coils shall consist of open coils of high grade nickel and chromium resistance wire or nichrome elements and insulated with ceramic insulators in galvanized steel brackets, supported in heavy gauge galvanized steel frames. Each unit employing an electric heating coil shall be constructed and installed in accordance with the requirements of the local authorities and shall be UL or ETL listed specifically with the heater as a component of the terminal unit device.

b. Coils shall have the capacities indicated in Contract Documents. Coils rated up through 15.5 kW shall be single phase, 347 volt, 60 hertz and coils larger than 15.5 kW shall be three phase, four wire, 207, 480 or 600 volt, 60 hertz.

c. Terminal bolts, nuts and washers shall be of corrosion resistant materials. Coils shall be constructed so the installation may be accomplished in accordance with the provisions of the National Electrical Code, for zero clearance. Coils shall be given a 2000 volt dielectric test at the factory.

d. Automatic reset thermal cutouts shall be furnished for primary protection with manually resettable limit switches in power circuits for secondary protection. Both devices shall be serviceable through terminal box without removing heating element from the terminal device. The air pressure safety cutout pickup probe shall be remotely mounted near the volume control damper for maximum fidelity.

e. Heating coils shall have a terminal box and cover, with quiet type built-in magnetic step controlled contactors for each circuit, branch circuit fusing for each branch circuit on heaters over 45 amps per the NEC and an air flow safety interlock switch for installation in the heater control enclosure. Provide a 120 or 24 VAC control power transformer with an integral or separately mounted primary and/or secondary overcurrent protection device in accordance with NEC requirements.

Single Duct Terminal Units • 30HQ Series

Model 30HQ • Hospital Grade Unit OPTIONS (continued)

f. All wiring of built-in devices shall be brought to clearly marked terminal strips. A complete wiring diagram shall be permanently attached to the heating coil panel cover.

An electric heater shall be factory mounted and pre-wired as an integral package with the fan powered terminal unit. Heaters shall be sized as shown on the drawings. The entire assembly including the electric heater shall be ETL listed for zero clearance and so labeled and shall meet all requirements of the latest National Electrical Code, (CSA C22.2 No.236). The unit shall have a single point electrical and/or pneumatic connection (dual point electrical on 600V). Heater casing and panel shall be a minimum of 20 ga. (1.00) galvanized steel. Each heater shall be complete with automatic reset high limit thermal cut-outs, control voltage transformer as required, ground terminal, fan relay for interlocking the heater and fan and high grade nickel chrome alloy wire. Element wires shall be supported by ceramic isolators. Each heater shall be supplied with factory supplied and pre-wired branch circuit fusing as required by NEC and UL. Circuiting and fusing shall also be in accordance with the circuiting requirements as shown on the plans.

Additional accessories shall include (control transformer, circuit fusing, disconnect switch, pneumatic electric switches) for heater control. The SCR controller shall contain a discharge temperature sensor capable of limiting leaving air temperature to a user defined setpoint. The SCR controller shall pulse the coil to maintain zone demand while providing the set maximum discharge air temperature. Upon measuring a discharge air temperature above the user defined setpoint, the controller shall reduce heater capacity to maintain maximum allowable discharge air temperature. The discharge air temperature setpoint shall be adjustable from 80 – 100°F (27 – 149°C) by use of a controller mounted potentiometer.

g. Electric heating coils shall be designed for operation with the DDC controller and control system.

h. Electric heating coils and the associated control panels shall be constructed as a component of the entire terminal unit and mounted in the discharge attenuator downstream of the terminal unit. The resulting unit, including the heater, the VAV damper and the dissipative silencer shall be no longer than 79" (2007) in length.

i. The manufacturer shall prove adequate even airflow over the electric heating coil under the full range of airflow scheduled (minimum to maximum) to prevent uneven heating of the electric coils. The terminal device shall be listed in accordance with UL 1995 as a composite assembly consisting of the VAV terminal device and the electric heating device.

j. Shop Drawings shall be submitted for review. Drawings shall indicate specifically the exact construction, materials, internal wiring, NEC working clearances, etc., of the terminal units and electric heating coils to be furnished under these Specifications.

Hot Water Heating Coils:

Model: 30HQW

(Substitute the following paragraphs:)

30HQW

1. Furnish and install **Nailor 30HQW Single Duct Variable Volume Hospital Grade Terminal Units** of the sizes and capabilities as indicated on the drawings. Units shall be pressure independent with (DDC, analog electronic, pneumatic) controls. Units shall reset to any flow between minimum and the maximum cataloged airflow as allowed by the specific controller.

10. Single Duct Hospital Grade Terminal Device Hot Water Heating Coils

a. Terminal unit hot water heating coils shall be mounted on the

discharge of the unit with slip and drive connections. Provide an access door or panel on the bottom of the attenuator section of the terminal unit for servicing and cleaning the unit.

b. Hot water heating coils shall be constructed with copper tubes and aluminum plate fins. Coils shall have a maximum of 10 fins per inch. Supply and return connections shall be on the same end of the coil. Fins shall be bonded to the tubes by means of mechanical expansion of the tubes. Fins shall be at least .0045" (.11) thick.

c. Coils shall have galvanized steel casings on all sides no lighter than 22 ga. (1.00).

d. Tubes shall be ½" (13) O.D. and shall be spaced approximately 1 ¼" (32) apart and shall have a minimum wall thickness of 0.016" (.41). Hot water shall be equally distributed through all tubes by the use of orifices or header design. Water velocity in the tubes shall not exceed five feet per second. The water pressure drop through the coil shall not exceed 10 feet. Heating coil face velocities shall not exceed the maximum face velocity indicated in the schedules on the Contract Documents.

e. Coils shall be tested by air pressure under water. Coils shall be tested at 350 psi (2,413 kPa) air static pressure.

f. Coil ratings, calculations and selection data shall be in accordance with the applicable AHRI Standards and shall be submitted with the Shop Drawings.

EZvav Digital Controls

1.1 ASC VAV BACnet CONTROLLERS

A. Digital VAV Controllers shall be responsible for monitoring and controlling directly connected VAV Terminals as required. Controllers shall include fully adjustable analog outputs and digital outputs as required utilizing a proportional plus integral control loop to control damper, electric heat and hot water coils for the purpose of maintaining user setpoints. Each controller shall be classified as a native BACnet device, conforming to the BACnet Advanced Specific Controllers (B-ASC) profile, ANSI/ASHRAE BACnet Standard 135.

B. The VAV controller shall be available with integrated applications (based on model) for Single Duct, Dual Duct, and Fan Powered terminal units, including any of the following as required by the control sequence. For Single/Dual Duct terminals: Cooling Only, Cooling/Heating with Changeover and Morning Warm up. For Fan Powered terminals: Cooling with Reheat/Supplementary Heat, Heating coil operation may be with analog, floating or binary control as required.

C. The controller shall be fully configurable via the Digital Display Sensor, including communication parameters (instance, MAC, baud) and application settings (K-factor, flow limits, box configuration, reheat or fan type, default user setpoints, etc.), without any specific PC-based software. VAV controllers shall not require the use of a personal computer and PC based software and/or any interface modules.

D. The VAV controller shall be capable of being balanced from the Digital Room Sensor without any specific pc-based software.

E. The controller shall have integrated MS/TP communications. The communication port shall have network protection bulbs and integrated end-of-line (EOL) terminations.

F. The controller shall have an integrated actuator rated at 40 in-lbs. Connection to the damper shall be with a v-bolt clamp, accepting 3/8(B-ASC)" to 5/8(B-ASC)" damper shaft sizes. The actuator shall travel 0 to 95 degrees with adjustable end stops at 45 and 60 degrees of rotation. The actuator shall have an integrated gear disengagement mechanism.

G. The controller shall have an integrated transducer pressure sensor for airflow measurement. The sensor shall have a range or 0-2(B-ASC)"wc, consuming and accurate to 4.5% of reading or 0.0008(B-ASC)"wc, whichever is greater.

Single Duct Terminal Units

Model 30HQ • Hospital Grade Unit

OPTIONS (continued)

H. The controller shall have a Dedicated Room Sensor port for direct interface to a Digital Display Room Sensor or Discrete Room Sensor. The controller shall have the ability of detecting if a sensor has been connected to the port and identify its type, either digital display or discrete. Sensors shall be hot-swappable without powering down the controller. Sensor information via the ports shall not consume any of the devices terminated input capacity.

I. The controller shall have screw terminal blocks that can accommodate wire sizes 14-22 AWG. Terminals shall be color coded: black terminals for power, green terminals for input and outputs, and grey terminals for twisted-shielded-pair communication.

J. The power supply for the controller shall be 24 volts AC (-15%, +20%) power. Voltage below the operating range of the system shall be considered an outage.

1.2 DIGITAL ROOM SENSOR

A. The Digital Display Room Sensor (thermostat) shall provide space condition measurements and indications, including temperature and local motion/occupancy (optional), and user setpoint adjustments.

B. The Digital Room Sensor shall connect directly to the controller and shall not utilize any of the hardware I/O points of the controller. The Digital Display Room Sensor shall be able to be located up to 75' from the controller.

C. The Digital Display Room Sensor shall provide a Temporary Network Interface jack, field accessible without uninstalling the sensor, for connection to the BACnet MS/TP communication trunk to which the devices connected. The Digital Display Room Sensor, the connected controller, and all other devices on the BACnet network shall be accessible through the temporary communication jack. Microprocessor based sensors whose port only allows communication with the controller to which it is connected shall not be acceptable.

D. The Digital Display Room Sensor shall have an integrated sensor for temperature measurement as standard and a second integrated sensor for motion/occupancy (optional).

E. User/Occupant setpoints may be adjusted via the Digital Display Room Sensor.

F. The Digital Display Room Sensor shall have pre-configured menus for all control sequences allowing access to communication and application parameters.

G. The Digital Display Room Sensor shall have two levels of password protection: One level to protect user setpoint adjustment, and one level to protect configuration menu parameters. Passwords shall be at least 4 digits in length.

Model 30X • Exhaust • Basic Unit

1. Furnish and install **Nailor 30X Series Single Duct Variable Volume Exhaust Terminal Units** of the sizes and capabilities as indicated on the drawings. Units shall be pressure independent with DDC, analog electronic or pneumatic or controls. Units shall reset to any flow between minimum and the maximum cataloged airflow as allowed by the specific controller.

2. The entire exhaust terminal unit shall be designed and built as a single unit. The units shall be provided with a variable air volume damper that controls the air quantity in response to a control signal. The units shall also include all options such as attenuators and access doors. Exhaust units shall feature a venturi valve inlet with integrated flow sensor for optimized airflow performance and reduced pressure drop. The space limitations shall be reviewed carefully to insure that all units will fit into the space allowed.

3. Unit casing shall be 22 ga. (.86) galvanized steel with rectangular inlet and outlet connections, configured for slip and drive connections. Basic valve assembly shall not exceed 30" (762) in length. Casing leakage downstream of the damper shall not exceed 1% @ 1" w.g. (250 Pa). High side leakage shall not exceed 2% @ 3" w.g. (746 Pa).

4. Damper assemblies of 16 ga. (1.6) galvanized steel shall be multiple opposed blade construction arranged to close at 45 degrees from full open to minimize air turbulence and provide near linear operation. Damper blades shall be fitted with flexible seals for tight closure and minimized sound generation. Damper blades shall be screwed through the shaft to insure that no slippage occurs. Blade shafts shall pivot on corrosion free Celcon® bearings. In the fully closed position, air leakage past the closed damper shall not exceed 2% of the nominal catalog rating at 3" w.g. (746 Pa) inlet static pressure as rated by ASHRAE Standard 130.

5. The terminal unit shall be capable of operation as described herein with a minimum inlet static pressure that shall not exceed 0.37" w.g. (92 Pa) at 2000 fpm (10.2 m/s) inlet velocity for unit sizes 4 through 16. (The sequence of operations should be described here, if not part of the temperature controls specifications.) Gauge tap ports shall be supplied in the piping between the flow pick up and the controller.

6. Each unit shall be constructed with single point electrical connections. All electrical components shall be ETL or UL listed or recognized and installed in accordance with the National Electrical Code. All electrical components shall be installed in a control box. The entire assembly shall be ETL listed and so labeled.

7. Each unit shall be internally lined with ¾" (19) dual density fiberglass insulation. Edges shall be sealed against airflow erosion. Units shall meet NFPA 90A and UL 181 standards.

8. All sound data shall be compiled in an independent laboratory and in accordance with the latest version of AHRI Standard 880 and ANSI/ASHRAE Standard 130. All units shall be AHRI certified and bear the AHRI certification label.

9. The unit shall be capable of being changed from Right Hand to Left Hand configuration by flipping the unit over. No controls, field adjustments, nor field re-assembly shall be required to accomplish this. The unit shall be listed by UL or ETL under UL 1995 to operate in either orientation.

OPTIONS

Attenuator:

(Add the following paragraph to 30X Series:)

10. Attenuator section shall be 36" (914) long and constructed of 22 ga. (.86) galvanized steel. Inlet and discharge shall be rectangular and configured for slip and drive connections. Each attenuator section shall be internally lined with ¾" (19) dual density fiberglass insulation. Edges shall be sealed against airflow erosion. Units shall meet NFPA 90A and UL 181 standards.

Single Duct Terminal Units

Model 30HQX • Hospital Grade • Dissipative Silencer

1. Furnish and install **Nailor Model 30HQX Single Duct Variable Volume Exhaust Terminal Units** of the sizes and capabilities as indicated on the drawings. Units shall be pressure independent with DDC controls. Units shall reset to any flow between minimum and the maximum cataloged airflow as allowed by the specific controller.
2. The entire terminal unit shall be designed and built as a single unit. The units shall be provided with a variable air volume damper that controls the air quantity in response to a control signal. The units shall also include dissipative silencers and access doors. Exhaust units shall feature a venturi valve inlet with integrated flow sensor for optimized airflow performance and reduced pressure drop. The space limitations shall be reviewed carefully to insure that all units will fit into the space allowed.
3. Unit casing shall be 22 ga. (0.86) galvanized steel with rectangular inlet and outlet connections, configured for slip and drive connections. Casing leakage downstream of the damper shall not exceed 1% @ 1" w.g. (250 Pa). High side leakage shall not exceed 2% @ 3" w.g. (746 Pa).
4. Damper assemblies of 16 ga. (1.61) galvanized steel shall be multiple opposed blade construction arranged to close at 45 degrees from full open to minimize air turbulence and provide near linear operation. Damper blades shall be fitted with flexible seals for tight closure and minimized sound generation. Damper blades shall be screwed through the shaft to insure that no slippage occurs. Blade shafts shall pivot on corrosion free Celcon® bearings. In the fully closed position, air leakage past the closed damper shall not exceed 2% of the nominal catalog rating at 3" w.g. (746 Pa) inlet static pressure as rated by ASHRAE Standard 130.
5. The terminal unit shall be capable of operation as described herein with a minimum inlet static pressure that shall not exceed 0.40" w.g. (100 Pa) at 2000 fpm (10.2 m/s) inlet velocity for unit sizes 4 through 16. (The sequence of operations should be described here, if not part of the temperature controls specifications.) Gauge tap ports shall be supplied in the piping between the flow pick up and the controller.
6. Each unit shall be constructed with single point electrical connections. All electrical components shall be ETL or UL listed or recognized and installed in accordance with the National Electrical Code. All electrical components shall be installed in a control box. The entire assembly shall be ETL listed and so labeled.
7. Each section shall be internally lined with 13/16" (21) thick, 4 lb. density fiberglass insulation with a reinforced aluminum FSK facing. Units shall meet NFPA 90A and UL 181 standards.
8. All sound data shall be compiled in an independent laboratory and in accordance with the latest version of AHRI Standard 880 and ANSI/ASHRAE Standard 130. All units shall be AHRI certified and bear the AHRI certification label.
9. The unit shall be capable of being changed from Right Hand to Left Hand configuration by flipping the unit over. No controls, field adjustments, nor field re-assembly shall be required to accomplish this. The unit shall be listed by UL or ETL under UL 1995 to operate in either orientation.

10. Silencer sections shall contain a unit casing constructed of 22 ga. (.86) galvanized steel. Inlet and discharge shall be rectangular and configured for slip and drive connections. Each silencer section shall be internally lined with 13/16" (21) thick, 4 lb./cu. ft. (64 kg/m³) density fiberglass insulation with a reinforced aluminum FSK facing, placed inside the top and bottom sides of the silencer, thereby eliminating the requirement for field wrapping with thermal insulation. The silencer baffles shall be filled with fiberglass absorption media and encapsulated by 22 ga. (.86) perforated coated steel baffles. A mylar liner shall separate the fiberglass from the perforated baffle with an acoustical spacer and isolate the fiberglass from the airstream. The perforated metal baffles shall be rigidly fastened to the casing of the silencer. Units shall meet NFPA 90A and UL 181 standards.

Dual Duct Terminal Units • 3200 Series

Model 3210 • Without attenuator

1.01 Furnish and install **Nailor Model 3210 Dual Duct Variable Volume Terminal Units** of the sizes and capabilities as indicated on the drawings. Units shall be pressure independent with (DDC, analog electronic, pneumatic) controls. Units shall reset to any flow between 0 and the maximum cataloged airflow as allowed by the specific controller.

1.02 The terminal units shall be provided with two primary variable air volume dampers that control the air quantity in response to a (DDC, analog electronic, pneumatic) thermostat. The space limitations shall be reviewed carefully to insure that all units will fit into the space allowed.

1.03 Unit casing shall be 22 gauge galvanized steel with round or flat oval inlets with 5 ½" (140 mm) deep inlet duct collar for field connection. Outlets shall be rectangular and configured for slip and drive connections. Casing leakage downstream of the damper shall not exceed 1% at 1" w.g. (250 Pa). High side casing leakage shall not exceed 2% at 3" w.g. (750 Pa).

1.04 Damper assemblies of 16 gauge galvanized steel shall be multiple opposed blade construction arranged to close at 45 degrees from full open to minimize air turbulence and provide near linear operation. Damper blades shall be fitted with flexible seals for tight closure and minimized sound generation. Damper blades shall be screwed through the shaft to insure that no slippage occurs. Blade shafts shall pivot on corrosion free Celcon® bearings. In the fully closed position, air leakage past the closed damper shall not exceed 2% of the nominal catalog rating at 3" w.g. (750 Pa) inlet static pressure as rated by ASHRAE Standard 130.

1.05 The terminal units shall be capable of operation as described herein with an inlet static pressure of 0.10" w.g. (24 Pa) from 0 to 2000 fpm. (The sequence of operations should be described here, if not part of the temperature controls specifications.) Each unit shall be complete with factory mounted (DDC, analog electronic, pneumatic) controls. Gauge tap ports shall be supplied in the piping between the flow pick up and the controller.

1.06 Each unit shall be constructed with single point electrical (or pneumatic) connections. All electrical components shall be ETL or UL listed or recognized and installed in accordance with the National Electrical Code. All electrical components shall be installed in a control box. The entire assembly shall be ETL listed and so labeled.

1.07 Each unit shall be internally lined with ¾" (19) dual density fiberglass insulation. Edges shall be sealed against airflow erosion. Units shall meet NFPA 90A and UL 181 standards.

1.08 All sound data shall be compiled in an independent laboratory and in accordance with the latest version of AHRI Standard 880 and ANSI/ASHRAE Standard 130. All units shall be AHRI certified and bear the AHRI certification label.

Model 3230 • With compact mixing attenuator

1 Furnish and install **Nailor Model 3230 Dual Duct Variable Volume Terminal Units** of the sizes and capabilities as indicated on the drawings. Units shall be pressure independent with (DDC, analog electronic, pneumatic) controls. Units shall reset to any flow between minimum and the maximum cataloged airflow as allowed by the specific controller.

2 The terminal units shall be provided with two primary variable air volume dampers that control the air quantity in response to a (DDC, analog electronic, pneumatic) thermostat. The space limitations shall be reviewed carefully to insure that all units will fit into the space allowed.

3 Unit casing shall be 22 ga. (.86) galvanized steel with round or oval inlets with 5 ½" (140) deep inlet duct collar for field connection. Outlets shall be rectangular and configured for slip and drive connections. Casing leakage downstream of the damper shall not exceed 1% at 1" w.g. (250 Pa) of terminal rated airflow.

4 Damper assemblies of 16 ga. (1.63) galvanized steel shall be multiple opposed blade construction arranged to close at 45 degrees from full open to minimize air turbulence and provide near linear operation. Damper blades shall be fitted with exible seals for tight closure and minimized sound generation. Damper blades shall be screwed through the shaft to insure that no slippage occurs. Blade shafts shall pivot on corrosion free Celcon® self lubricating bearings. Damper leakage shall not exceed 2% of nominal terminal flow at 3" w.g. (750 Pa).

5 The terminal units shall be capable of operation as described herein with a minimum inlet static pressure that shall not exceed 0.66" w.g. (164 Pa) at 2000 fpm. (The sequence of operations should be described here, if not part of the temperature controls specifications.) Each unit shall be complete with factory mounted (DDC, analog electronic, pneumatic) controls.

6 Each unit shall be constructed with single point electrical (or pneumatic) connections. All electrical components shall be ETL or UL listed or recognized and installed in accordance with the National Electrical Code. All electrical components shall be installed in a control box. The entire assembly shall be ETL listed and so labeled.

7 Each unit shall be provided with two flow sensor. Flow sensors may be located in the cold or hot deck inlet or as a combination of inlet and total flow location. The airflow sensor shall be a multi-point averaging type Diamond Flow Sensor constructed of aluminum. Gauge tap ports shall be supplied in the piping between the Diamond Flow Sensor and the controller.

8 The easing shall include integral mixing baffles constructed inside a mixing attenuator to efficiently mix the cold and hot supply airstreams. When operating in mixing mode, the mixing attenuator shall provide an efficiently mixed cold and hot airstream so that the average discharge temperature variation is no more than 1°F (0.6°C) for every 12°F (6.7°C) difference between the cold and hot supply air temperatures.

9 Each unit shall be internally lined with ¾" (19) dual density fiberglass insulation. Edges shall be sealed against airflow erosion. Units shall meet NFPA 90A and UL 181 standards.

10 All sound data shall be compiled in an independent laboratory and in accordance with the latest version of AHRI Standard 880 and ANSI/ASHRAE Standard 130. All units shall be AHRI certified and bear the AHRI certification label.

Dual Duct Terminal Units • 3200 Series

Model 3240 • "BLENDMASTER™" with high efficiency mixing attenuator

1 Furnish and install Nailor Model 3240 "BLENDMASTER™" Dual Duct Variable Volume Terminal Units of the sizes and capabilities as indicated on the drawings. Units shall be pressure independent with (DDC, analog electronic, pneumatic) controls. Units shall reset to any flow between minimum and the maximum cataloged airflow as allowed by the specific controller.

2 The terminal units shall be provided with two primary variable air volume dampers that control the air quantity in response to a (DDC, electric, analog electronic, pneumatic) thermostat. The space limitations shall be reviewed carefully to insure that all units will fit into the space allowed.

3 Unit casing shall be 22 ga. (.86) galvanized steel with round or flat oval inlets with 5 1/2" (140) deep inlet duct collar for field connection. Outlets shall be rectangular and configured for slip and drive connections. Casing leakage downstream of the damper shall not exceed 1% at 1" w.g. (250 Pa) of terminal rated airflow. High side casing leakage shall not exceed 2% at 3" w.g. (750 Pa).

4 Damper assemblies of 16 ga. (1.63) galvanized steel shall be multiple opposed blade construction arranged to close at 45 degrees from full open to minimize air turbulence and provide near linear operation. Damper blades shall be fitted with flexible seals for tight closure and minimized sound generation. Damper blades shall be screwed through the shaft to insure that no slippage occurs. Blade shafts shall pivot on corrosion free Celcon® self lubricating bearings. Damper leakage shall not exceed 2% of nominal terminal airflow at 3" w.g. (750 Pa).

5 The terminal units shall be capable of operation as described herein with a minimum inlet static pressure that shall not exceed 0.51" w.g. (127 Pa) at 2000 fpm (10.2 m/s). (The sequence of operations should be described here, if not part of the temperature controls specifications.) Each unit shall be complete with factory mounted (DDC, analog electronic or pneumatic) controls.

6 Each unit shall be constructed with single point electrical (or pneumatic) connections. All electrical components shall be ETL or UL listed or recognized and installed in accordance with the National Electrical Code. All electrical components shall be installed in a control box. The entire assembly shall be ETL listed and so labeled.

7 Each unit shall be provide with two flow sensor. Flow sensors may be located in the cold or hot deck inlet or as a combination of inlet and total flow location. The airflow sensor shall be a multi-point averaging type Diamond Flow constructed of aluminum Sensor constructed of aluminum. Gauge tap ports shall be supplied in the piping between the Diamond Flow Sensor and the controller.

8 The easing shall include integral mixing baffles constructed inside a mixing attenuator to efficiently mix the cold and hot supply airstreams. When operating in mixing mode, the mixing attenuator shall provide an efficiently mixed cold and hot airstream so that the average discharge temperature variation is no more than 1°F (0.6°C) for every 30°F (16.7°C) difference between the cold and hot supply air temperatures.

9 Each unit shall be internally lined with 3/4" (19) dual density fiberglass insulation. Edges shall be sealed against airflow erosion. Units shall meet NFPA 90A and UL 181 standards.

10 All sound data shall be compiled in an independent laboratory and in accordance with the latest version of AHRI Standard 880 and ANSI/ASHRAE Standard 130. All units shall be AHRI certified and bear the AHRI certification label.

Control Specifications (select one)

EZvav Digital Controls

1.1 ASC VAV BACnet CONTROLLERS

A. Digital VAV Controllers shall be responsible for monitoring and controlling directly connected VAV Terminals as required. Controllers shall include fully adjustable analog outputs and digital outputs as required utilizing a proportional plus integral control loop to control damper, electric heat and hot water coils for the purpose of maintaining user setpoints. Each controller shall be classified as a native BACnet device, conforming to the BACnet Advanced Specific Controllers (B-ASC) profile, ANSI/ASHRAE BACnet Standard 135.

B. The VAV controller shall be available with integrated applications (based on model) for Single Duct, Dual Duct, and Fan Powered terminal units, including any of the following as required by the control sequence. For Single/Dual Duct terminals: Cooling Only, Cooling/Heating with Changeover and Morning Warm up. For Fan Powered terminals: Cooling with Reheat/Supplementary Heat, Heating coil operation may be with analog, floating or binary control as required.

C. The controller shall be fully configurable via the Digital Display Sensor, including communication parameters (instance, MAC, baud) and application settings (K-factor, flow limits, box configuration, reheat or fan type, default user setpoints, etc.), without any specific PC-based software. VAV controllers shall not require the use of a personal computer and PC based software and/or any interface modules.

D. The VAV controller shall be capable of being balanced from the Digital Room Sensor without any specific pc-based software.

E. The controller shall have integrated MS/TP communications. The communication port shall have network protection bulbs and integrated end-of-line (EOL) terminations.

F. The controller shall have an integrated actuator rated at 40 in-lbs. Connection to the damper shall be with a v-bolt clamp, accepting 3/8" to 5/8" damper shaft sizes. The actuator shall travel 0 to 95 degrees with adjustable end stops at 45 and 60 degrees of rotation. The actuator shall have an integrated gear disengagement mechanism.

G. The controller shall have an integrated transducer pressure sensor for airflow measurement. The sensor shall have a range or 0-2"wc, consuming and accurate to 4.5% of reading or 0.0008"wc, whichever is greater.

H. The controller shall have a Dedicated Room Sensor port for direct interface to a Digital Display Room Sensor or Discrete Room Sensor. The controller shall have the ability of detecting if a sensor has been connected to the port and identify its type, either digital display or discrete. Sensors shall be hot-swappable without powering down the controller. Sensor information via the ports shall not consume any of the devices terminated input capacity.

I. The controller shall have screw terminal blocks that can accommodate wire sizes 14-22 AWG. Terminals shall be color coded: black terminals for power, green terminals for input and outputs, and grey terminals for twisted-shielded-pair communication.

J. The power supply for the controller shall be 24 volts AC (-15%, +20%) power. Voltage below the operating range of the system shall be considered an outage.

1.2 DIGITAL ROOM SENSOR

A. The Digital Display Room Sensor (thermostat) shall provide space condition measurements and indications, including temperature and local motion/occupancy (optional), and user setpoint adjustments.

B. The Digital Room Sensor shall connect directly to the controller and shall not utilize any of the hardware I/O points of the controller. The Digital Display Room Sensor shall be able to be located up to 75' from the controller.

Dual Duct Terminal Units • 3200 Series

Control Specifications (select one) (continued)

C. The Digital Display Room Sensor shall provide a Temporary Network Interface jack, field accessible without uninstalling the sensor, for connection to the BACnet MS/TP communication trunk to which the devices connected. The Digital Display Room Sensor, the connected controller, and all other devices on the BACnet network shall be accessible through the temporary communication jack. Microprocessor based sensors whose port only allows communication with the controller to which it is connected shall not be acceptable.

D. The Digital Display Room Sensor shall have an integrated sensor for temperature measurement as standard and a second integrated sensor for motion/occupancy (optional).

E. User/Occupant setpoints may be adjusted via the Digital Display Room Sensor.

F. The Digital Display Room Sensor shall have pre-configured menus for all control sequences allowing access to communication and application parameters.

G. The Digital Display Room Sensor shall have two levels of password protection: One level to protect user setpoint adjustment, and one level to protect configuration menu parameters. Passwords shall be at least 4 digits in length.

Digital (DDC) Controls (Pressure Independent) Factory Mounting Procedure

1. The terminals shall be equipped with pressure independent direct digital controls supplied by the control contractor under the automatic temperature controls Division 17 and mounted by the terminal unit manufacturer. The control contractor shall, in addition to sending the controls to the terminal unit manufacturer, provide technical data sheets for all components to be mounted, including dimensional data, mounting hardware and method, as well as application specific wiring and piping diagrams for each terminal type as depicted on the schedules and mechanical drawings.

2. Controls shall be compatible with the pneumatic 'Diamond Flow' multi-point averaging flow sensor supplied by the terminal manufacturer. Sensors shall have four pick-up points on each side to ensure that controller fidelity shall be $\pm 5\%$ of set volume with any typical air turbulence in the duct and any typical flex inlet condition and with an inlet static variation of 0.05" w.g. to 6.0" w.g. (12 – 1500 Pa). The sensor shall amplify the sensed velocity pressure and provide a minimum differential pressure of 0.03" w.g. (7.46 Pa) at 500 fpm (2.54 m/s) inlet velocity. Flow measuring taps and flow curves shall be furnished with each terminal.

3. Controls shall be configured and field calibrated in the field by the control contractor after terminal installation has been completed. Pneumatic tubing shall be UL Listed fire retardant (FR) type. Each terminal shall be supplied with a label showing unit type, model number, size and tag location.

4. The terminal manufacturer shall provide a Class 2, 24 VAC control transformer with internal current limiting protection and disconnect switch. All controls shall be installed in an approved NEMA 1 enclosure supplied and installed by the terminal manufacturer.

Analog Electronic Controls (Pressure Independent)

1. The terminal unit manufacturer shall provide factory mounted pressure independent analog electronic controls which can be reset to modulate airflow between zero and the maximum cataloged capacity. Each terminal shall be equipped with labels showing unit size, location and minimum and maximum airflow settings. Controls shall be factory calibrated and set for the scheduled minimum and maximum flow rates.

2. Units shall be supplied with two **Nailor** Diamond flow sensors with four pick-up points on each side to ensure that controller fidelity shall be within $\pm 5\%$ of set volume under various same size duct inlet conditions and inlet static variation of 0.05" – 6.0" w.g. (12 – 1500 Pa). The sensor shall amplify the sensed velocity pressure and provide a minimum differential pressure of 0.03" w.g. (7.46 Pa) at 500 fpm (2.54 m/s) inlet velocity. Flow measuring taps shall be furnished with each terminal. All pneumatic tubing shall be UL listed for fire retardant (FR) type.

3. Velocity controllers shall have a constant 2°F (1.11°C) reset span regardless of minimum and maximum airflow limits. They shall include an onboard flow-through transducer utilizing twin platinum resistance temperature detectors and shall be capable of controlling a velocity set point from 0 – 3300 fpm with an accuracy of 3%. The controller shall allow all airflow adjustments to be made from the matching room thermostat. The thermostat shall be furnished by the terminal unit manufacturer and provide a live velocity readout and feature semi-concealed set point slider(s) and set point indicator(s) and thermometer with a fahrenheit (centigrade optional) scale plate.

4. The terminal shall have two 24 VAC combination controller/actuator single assemblies. The actuator shall be of a direct drive design and provide a minimum torque of 50 in. lbs. (5.6 Nm). Actuators shall be of the floating reversible type and include a magnetic clutch, adjustable stops and a gear disengagement button. A tri-color LED shall indicate green for opening, red for closing and white for satisfied damper positions. Power consumption of the controller/actuator shall not exceed 4 VA.

5. The terminal manufacturer shall provide a Class 2, 24 VAC control transformer with internal current limiting protection. All controls shall be installed in an approved NEMA 1 enclosure.

Pneumatic Controls (Pressure Independent)

1. The terminal unit manufacturer shall provide factory mounted pressure independent controls which can be reset to modulate airflow between minimum and the maximum cataloged capacity. Maximum airflow limits or mechanical volume regulators are not acceptable.

2. Each unit shall be supplied with two **Nailor** Diamond flow sensors with four pick-up points on each side to ensure that controller fidelity shall be within $\pm 5\%$ of set volume under various same size duct inlet conditions and inlet static variation of 0.05" – 6.0" w.g. (12 – 1500 Pa). The sensor shall amplify the sensed velocity pressure and provide a minimum differential pressure of 0.03" w.g. (7.46 Pa) at 500 fpm (2.54 m/s) inlet velocity. Flow measuring taps shall be furnished with each terminal.

3. Reset volume flow controllers shall have a constant reset span regardless of the minimum and maximum airflow settings selected. Reset span shall be adjustable from a minimum of 5 psi up to a maximum of 10 psi. Reset start point shall be adjustable from 3 – 10 psi. Controller air bleed off through the flow sensor is not acceptable. Controller shall be field convertible for direct or reverse acting. The compressed air consumption of each controller shall not exceed 1.0 SCFH at 20 psi. Acceptable controller is Kreuter CSC-3011 or equal.

4. Reset volume controllers shall be factory calibrated and set for the scheduled maximum and minimum airflow settings. Flow measuring taps and flow charts shall be supplied with each terminal unit for field balancing and adjustment of airflow. All pneumatic tubing shall be UL listed fire retardant (FR) type. Each terminal shall be supplied with a label showing unit type, size, tag location, minimum and maximum airflow settings and control sequence number. Pneumatic spring return actuators shall be provided and factory mounted by the terminal unit manufacturer.

5. Reset volume controllers shall be factory set and calibrated for operation with a direct/reverse (select one) acting room thermostat. The cold duct actuator/damper connection shall be factory mounted to fail to a normally open/closed (select one) position upon loss of control main air pressure. The hot duct actuator/damper connection shall be factory mounted to fail to an open/closed (select one) position.

Fan Powered Chilled Water Terminal Units • 33SZ Series

Model 33SZ • Series Flow (Constant or Variable Volume)

1. Basis: Nailor Industries, Inc.
 - a. Fan Powered Chilled Water Terminal: Model 33SZ.
2. General:
 - a. Furnish and install fan powered chilled water terminals of the sizes and capacities as indicated on the drawings. Terminals shall be pressure independent with direct digital controls.
 - b. The terminal shall be factory assembled and wired as a single unit. A single unit assembly shall consist of a series type fan powered terminal with motor/blower, primary air damper, and induction-side water coil with integral drip pan.
 - c. All airflow, electrical and sound performance data shall be compiled in an independent laboratory and in accordance with the latest version of ASHRAE Standard 130 and AHRI Standard 880. The unit shall be performance tested as a complete assembly with the induction-side water coil installed on the unit.
3. Unit Casing:
 - a. General
 - i. Unit casing shall have full size access panels for easy access to motor and blower assembly and for maintenance and replacement of parts without disturbing duct connections. Access panels shall be attached to casing with (screws, quarter-turn fasteners). Casing leakage shall not exceed 2% of terminal rated airflow at 0.5" w.g. (125 Pa) interior casing pressure. All high side casing joints shall be sealed with approved gasket/sealant and high side casing leakage shall not exceed 2% of terminal rated airflow at 3" w.g. (750 Pa).
 - b. Low Profile (less than 12")
 - i. Unit casings shall be 20 ga. (1.00) galvanized steel construction with 20 ga. (1.00) galvanized steel panels. Units shall have round inlet collars for the primary air connections and shall be 6" (152) deep for field connection. The outlets shall be rectangular and suitable for flanged duct connections. Casing shall have mounting area for hanging by sheet metal straps from a concrete slab.
 - ii. Unit casing shall have two access panels, one on top and bottom.
 - c. Standard Profile
 - i. Unit casings shall be space frame construction utilizing 18 ga. (1.31) galvanized steel corner structural members and 20 ga. (1.00) galvanized steel panels. Units shall have round inlet collars for the primary air connections and shall be 6" (152) deep for field connection. The outlets shall be rectangular and suitable for flanged duct connections. Casing shall have mounting area for hanging by sheet metal straps from a concrete slab.
 - ii. Unit casing shall have three access panels, one on the side of the unit and one on top and bottom.
4. Unit Liner:
 - a. Unit shall be fully lined internally with insulation, which shall comply with NFPA 90 (ASTM E84, ASTM C1071) for a flame/smoke spread rating of 25/50. Insulation shall comply with UL 181 for erosion and any exposed, fibrous edges of insulation shall be coated with an NFPA 90 approved sealant.
 - i. Standard - Dual Density Fiberglass
 1. Size 30 - 1/2" (13) thick with R-value of 1.9.
 2. Size 40/50 - 3/4" (19) thick with R-value of 2.8.
 - ii. Optional - Steri-Liner, Foil Duct Board
 1. Size 30 - 1/2" (13) thick with R-value of 2.2.
 2. Size 40/50 - 13/16" (21) thick with R-value of 3.5.
 - iii. Optional - Fiber-Free Foam
 1. Size 30 - 1/2" (13) thick with R-value of 2.0.
 2. Size 40/50 - 3/4" (19) thick Foam with R-value of 3.0.
5. Primary Air Damper
 - a. The damper shall be of rectangular, multiple inclined opposed blade construction and designed to operate on a 45° arc. Blades shall be minimum 16 ga. (1.61) galvanized steel, single thickness construction with heavy duty gasket glued to the blades. The blades shall be screwed through the damper shaft to ensure that no slippage occurs. Blade shafts shall pivot on corrosion free bearings. Damper leakage shall not exceed 2% of the terminal rated cfm at 3" w.g. (750 Pa) inlet static pressure.
6. Motor/Blower Assembly
 - a. Blower casings shall be constructed of heavy gauge coated steel. Blower wheels shall be forward curved centrifugal type, dynamically balanced and driven by a direct drive variable speed, Electronically Commutated Motor (ECM) with "EPIC Fan Technology". The ECM shall maintain a minimum of 70% efficiency over its entire operating range. ECM shall be suitable for 60 Hz, 120/208/240/277 volt single phase power.
 - b. ECM shall be complete with and operated by a single phase integrated controller/inverter that operates the wound stator and senses rotor position to electrically commutate the stator. All motors shall be designed for synchronous rotation. Motor rotor shall be permanent magnet type with near zero rotor losses. Motor shall have built-in soft start and slewed speed change ramps. Motor shall be permanently lubricated with ball bearings, built-in overload protection and an anti-backward rotation system.
 - c. ECMs shall be factory programmed for the specific unit blower motor combination and shall be controlled by an integral device (Nailor "EPIC" fan card) provided by the unit manufacturer, capable of maintaining scheduled supply fan airflow settings within the applicable airflow range of the unit to within ±5%, regardless of system pressure variations.
7. Induction Water Coil
 - a. A chilled water coil shall be factory mounted as an integral package with the fan powered terminal unit. Chilled water coils shall be sized as shown on the drawings. Coil casing and panels shall be a minimum of 20 ga. (1.00) galvanized steel. Coils shall be 2, 4 or 6 row as required and sensible cooling capacities shall be as shown on the plans. Coils shall have aluminum plate fins spaced 10 per inch and bonded to 1/2" (13) O.D. copper tubes. Copper connections shall be sweat. All coils shall be tested at a minimum of 300 psi (2.1 MPa) under water to produce a guaranteed working pressure of 250 psi (1.7 MPa). All coils shall be performance rated and certified in accordance with the current edition of AHRI Standard 410. The space limitations shall be reviewed carefully to ensure that all units will fit into the space allowed.
 - b. An integral drip pan shall be mounted to the bottom of the chilled water coil without increasing the finished height of the unit assembly. The drip pan shall be constructed of a minimum of 20 ga. (1.00) single wall galvanized steel.
8. Optional "Stealth" Dissipative Silencer
 - a. Silencer shall be constructed of 22 ga. (0.86) coated steel with perforated baffles and encapsulated fiberglass acoustic media. The silencer shall be factory designed and tested to provide maximum acoustic attenuation by reducing radiated sound power levels.
9. Electrical Requirements
 - a. Units shall incorporate a single point electrical connection for the entire unit. All electrical components shall be UL or ETL listed or recognized and installed in accordance with the National Electrical Code. All electrical components shall be mounted in a control box. The entire assembly shall be ETL listed (cETL in Canada) and so labeled.
10. Controls
 - a. Terminal unit shall be provided with factory mounted Direct Digital Controls (supplied by controls contractor). All components including all controls with exception to the room thermostat,

Fan Powered Chilled Water Terminal Units • 33SZ Series

optional condensation sensor, optional attenuator section and pneumatic piping/field wiring shall be factory installed and mounted with the unit.

- b. A digital flow control device shall be provided that will limit the maximum and minimum airflow to that scheduled on the drawings. Airflow limits shall be factory set. Thermostat signal shall reset the flow control device to adjust primary airflow to match load requirements. Control of the terminal unit shall be pressure independent.

Electric Heat

(Substitute the following paragraphs:)

1. Furnish and install series flow (constant or variable volume) fan powered chilled water terminal units with integral electric heat of the sizes and capacities as indicated on the drawings. Units shall be pressure independent with digital controls. Units shall be manufactured by **Nailor Industries Inc. Model 33SZE**.
11. An electric heater shall be factory mounted and pre-wired as an integral package with the fan powered chilled water terminal unit. Heaters shall be sized as shown on the drawings. The entire assembly including the electric heater shall be ETL listed (cETL in Canada) for zero clearance and so labeled and shall meet all requirements of the latest National Electrical Code (Canadian Electrical Code, CSA Standard C22.1). The unit with the heater mounted shall be listed and rated to be turned over for either left or right hand configuration. The unit shall have a single point electrical (and pneumatic) connection. Heater casing and panel shall be a minimum of 20 ga. (1.00) galvanized steel. Each heater shall be complete with primary disc type automatic high limit, contactors as required, ground terminal, fan relay for interlocking the heater and fan and high grade nickel chrome alloy resistance wire. Element wires shall be suspended in insulators designed to expose the entire face area of the wire thereby eliminating hot spots. Each heater shall be supplied with factory supplied and pre-wired branch circuit fusing as required by NEC and UL. Circuiting and fusing shall also be in accordance with the circuiting requirements as shown on the plans. Additional accessories shall include (control transformer, circuit fusing, disconnect switch, electric step controller, pneumatic electric switches) for staging the heater.

(Additional performance requirements that you might want to include can be found in the electric heater section). The electric heater shall be located on the discharge side of the fan so as not to add heat to the motor and shorten its expected lifetime.

Heater voltage and stages to be as follows:

- 0 to 5.0 kW 277V/1 phase, 1 Step
- 5.1 kW and up 480V/3 phase, 1 Step

Hot Water Heating Coils

(Substitute the following paragraphs:)

1. Furnish and install series flow (constant or variable volume) fan powered chilled water terminal units with integral hot water coils of the sizes and capacities as indicated on the drawings. Units shall be pressure independent with digital controls. Units shall be manufactured by Nailor Industries Inc. Model 33SZW.
11. A hot water coil shall be factory mounted as an integral package with the fan powered terminal unit. Hot water coils shall be sized as shown on the drawings. The entire assembly including the hot water coil shall be ETL listed (cETL in Canada) for zero clearance and so labeled and shall meet all requirements of the latest National Electrical Code. The unit shall have a single point electrical (and pneumatic) connection. Water coil casing and panels shall be a minimum of 18 ga. (1.31) galvanized steel. Access panels shall be supplied on the top and bottom of the unit for easy access to the coil for inspection and cleaning. Coils shall be 1 or 2 row as required and heating capacities shall be as shown on the plans. Coils shall have aluminum plate fins spaced 10 per inch and bonded to 1/2" (13) O.D. copper tubes. Copper connections shall be sweat. All coils shall be tested at a minimum of 300 psi (2.1 MPa) under water to produce a guaranteed working pressure of 250 psi (1.7 MPa). Controls and valves for the hot water coils shall be field mounted. Heating coils shall be located on the discharge side of the fan so as not to add heat to the motor and shorten its expected lifetime.

Fan Powered Terminal Units • 35S Series

Model 35S • Series Flow (Constant or Variable Volume)

1. Furnish and install constant or variable volume series fan powered terminal units of the sizes and capacities as indicated on the drawings. Units shall be pressure independent with (digital electronic, analog electronic, pneumatic) controls. Units shall be manufactured by **Nailor Industries Inc. Model 35S**.
2. The entire terminal unit shall be designed and built as a single unit. The units shall be provided with a primary variable air volume damper that controls the air quantity in response to a (electronic, pneumatic) thermostat. The space limitations shall be reviewed carefully to ensure that all units will fit into the space allowed.
3. Unit casings shall be space frame construction utilizing 18 ga. (1.31) galvanized steel corner structural members and 20 ga. (1.00) galvanized steel panels. Unit shall be fully lined with fiberglass insulation which shall be at least 3/4" (19) thick dual density insulation complying with NFPA 90 for fire and smoke resistivity and UL 181 for erosion. Any cut edges of insulation shall be coated with NFPA 90 approved sealant.
4. Unit casing shall have four access panels, one on each side of the unit and one on the bottom and top for easy access to motor and blower assembly and for maintenance and replacement of parts without disturbing duct connections. The unit shall be rated to operate in left hand or right hand mode by turning the unit over. Access panels shall be attached to casing with (screws, quick acting latches, hinges). Casing leakage shall not exceed 2% of terminal rated airflow at 0.5" w.g. (125 Pa) interior casing pressure. All high side casing joints shall be sealed with approved sealant and high side casing leakage shall not exceed 2% of terminal rated airflow at 3" w.g. (750 Pa).
5. Units shall have round inlets for the primary air connections and shall have a 6" (152) deep inlet duct collar for field connection. The outlets shall be rectangular and suitable for flanged duct connections. Casing shall have mounting area for hanging by sheet metal straps from a concrete slab.
6. The damper shall be of rectangular, multiple inclined opposed blade construction and designed to operate on a 45° arc. Blades shall be minimum 16 ga. (1.61) galvanized steel, single thickness construction with heavy duty gasket glued to the blades. The blades shall be screwed through the damper shaft to ensure that no slippage occurs. Blade shafts shall pivot on corrosion free bearings. Damper leakage shall not exceed 2% of the terminal rated cfm at 3" w.g. (750 Pa) inlet static pressure.
7. Entire terminal unit shall be factory assembled with (electronic, pneumatic) controls. All components including all controls except the room thermostat and (pneumatic piping, field wiring) shall be factory installed and mounted with the unit.
8. Provide a (digital electronic, analog electronic, pneumatic) flow control device that will limit the maximum and minimum airflow to that scheduled on the drawings. Airflow limits shall be factory set. Thermostat signal shall reset the flow control device to adjust primary airflow to match load requirements. Control of the terminal unit shall be pressure independent.
9. The terminal unit shall be capable of operation as described herein with inlet static pressure of 0.05" w.g. (12 Pa) at full cooling with no mixing of induced and primary air. (The sequence of operation should be described here, if not part of the temperature controls specifications). Mixing of the primary and secondary airstreams shall be such that no more than 2.5° F (1.4°C) variation shall exist in the discharge airstream for each 20° F (11.1°C) of difference between the primary and secondary airstreams.
10. Blower casings shall be constructed of heavy gauge coated steel. Blower wheel shall be forward curved centrifugal type, dynamically balanced and driven by direct drive, single speed split capacitor motors. Motors shall be suitable for 120 or 208 or 240 or 277 volt single phase power. Motors shall have built-in overload protection,

bearings capable of low rpm oiling, permanently oiled bearings and a built-in anti-backward rotation device. Fan assembly shall be mounted so as to isolate the casing from the motor and blower vibration at no less than four points. Isolation shall be supplied at the motor and at the blower mounting points.

11. An electronic motor speed controller sized and designed for the specific blower motor combination shall be provided to allow infinitely adjustable fan speed from the minimum voltage stop to the line voltage signal to the motor. A minimum voltage stop shall be employed to ensure that fan cannot run in stall mode.
12. Units shall incorporate a single point electrical (and pneumatic) connection for the entire unit. All electrical components shall be UL or ETL listed or recognized and installed in accordance with the National Electrical Code. All electrical components shall be mounted in a control box. The entire assembly shall be ETL listed (cETL in Canada) and so labeled.
13. All sound data shall be compiled in an independent laboratory and in accordance with the latest version of AHRI Standard 880. All units shall be AHRI certified and bear the AHRI certification label.
14. Unit maximum radiated sound power levels at 1.0" w.g. (249 Pa) inlet pressure and 0.25" w.g. (63 Pa) discharge static pressure shall not exceed the values in Tables 1 and 2 at the specified airflow. No credit or reduction shall in any way be considered for room, plenum, ceiling and/or similar item effects.

Unit Size	Airflow		Sound Power Octave Band Center Frequency (Hz.)						
	cfm	l/s	2	3	4	5	6	7	
			125	250	500	1000	2000	4000	
1	400	189	66	61	56	52	54	54	
2	550	260	62	58	53	50	53	54	
3	700	330	61	59	56	54	54	55	
4	1200	566	68	64	60	59	57	56	
5	1600	755	69	65	60	57	57	57	
6	2100	991	74	70	63	62	60	59	
7	2800	1321	70	68	64	58	55	55	

Table 1. Maximum Radiated Sound Power Levels
Full Cooling (Fan on and 100% primary air)

Unit Size	Airflow		Sound Power Octave Band Center Frequency (Hz.)						
	cfm	l/s	2	3	4	5	6	7	
			125	250	500	1000	2000	4000	
1	400	189	64	60	55	48	44	40	
2	550	260	60	55	50	45	39	34	
3	700	330	59	55	52	48	43	38	
4	1200	566	65	60	55	53	50	48	
5	1600	755	68	63	57	54	51	47	
6	2100	991	72	69	62	60	59	57	
7	2800	1321	70	67	61	55	50	49	

Table 2. Maximum Radiated Sound Power Levels
Full heating (Fan only)

15. Unit maximum discharge sound power levels at 1.0" w.g. (249 Pa) inlet pressure and 0.25" w.g. (63 Pa) discharge static pressure shall not exceed the values in Table 3 at the specified airflow. No credit or reduction shall in any way be considered for room, downstream duct, elbows and/or similar item effects.

Unit Size	Airflow		Sound Power Octave Band Center Frequency (Hz.)						
	cfm	l/s	2	3	4	5	6	7	
			125	250	500	1000	2000	4000	
1	400	189	71	69	63	60	57	53	
2	550	260	70	67	61	57	54	50	
3	700	330	68	65	62	58	54	50	
4	1200	566	78	75	70	68	65	63	
5	1600	755	79	75	71	69	67	66	
6	2100	991	79	79	76	78	75	74	
7	2800	1321	79	75	71	70	68	66	

Table 3. Maximum Discharge Sound Power Levels
Full cooling (Fan on and 100% primary air)

Fan Powered Terminal Units • 35S Series

Model 35S • Series Flow (Constant or Variable Volume) (continued)

Motor: ECM

(Substitute the following paragraphs:)

10. Blower casings shall be constructed of heavy gauge coated steel. Blower wheel shall be forward curved centrifugal type, dynamically balanced and driven by Electronically Commutated Motor(s). Motor(s) shall be suitable for 120 or 208 or 240 or 277 volt single phase power. Fan airflow volume shall be factory set. Fan assembly shall be mounted so as to isolate the casing from the motor and blower vibration at no less than four points. Isolation shall be supplied at the motor and at the blower mounting points. A gasketed backdraft damper shall be included on the fan discharge to reduce primary air leakage back into the plenum space.

OPTIONS

"STEALTH™"

(Substitute the following paragraphs:)

1. Furnish and install series flow (constant or variable volume) fan powered terminal units of the sizes and capacities as indicated on the drawings. Units shall be pressure independent with (digital electronic, analog electronic, pneumatic,) controls. Units shall be manufactured by **Nailor Industries Inc. Model 35SST "Stealth™"**.

4. Unit maximum radiated sound power levels at 1.0" w.g. (249 Pa) inlet pressure and 0.25" w.g. (63 Pa) discharge static pressure shall not exceed the values in Tables 4 and 5 at the specified airflow. No credit or reduction shall in any way be considered for room, plenum, ceiling and/or similar item effects.

Unit Size	Airflow		Sound Power Octave Band Center Frequency (Hz.)						
	cfm	l/s	2	3	4	5	6	7	
			125	250	500	1000	2000	4000	
1	400	189	63	61	53	46	43	41	
2	550	260	60	59	51	45	43	42	
3	700	330	58	58	50	45	42	41	
4	1200	566	67	62	56	52	49	47	
5	1600	755	68	63	56	51	48	46	
6	2100	991	71	66	60	56	52	49	
7	2800	1321	70	64	58	53	49	47	

Table 4. Maximum Radiated Sound Power Levels
Full Cooling (Fan on and 100% primary air)

Unit Size	Airflow		Sound Power Octave Band Center Frequency (Hz.)						
	cfm	l/s	2	3	4	5	6	7	
			125	250	500	1000	2000	4000	
1	400	189	62	59	52	45	41	37	
2	550	260	57	53	46	39	36	33	
3	700	330	55	53	47	41	36	32	
4	1200	566	63	58	52	48	45	44	
5	1600	755	66	60	54	50	46	42	
6	2100	991	70	65	59	55	51	47	
7	2800	1321	69	65	56	53	50	46	

Table 5. Maximum Radiated Sound Power Levels
Full Heating (Fan only)

15. Unit maximum discharge sound power levels at 1.0" w.g. (249 Pa) inlet pressure and 0.25" w.g. (63 Pa) discharge static pressure shall not exceed the values in Table 6 at the specified airflow. No credit or reduction shall in any way be considered for room, downstream duct, elbows and/or similar item effects.

Unit Size	Airflow		Sound Power Octave Band Center Frequency (Hz.)						
	cfm	l/s	2	3	4	5	6	7	
			125	250	500	1000	2000	4000	
1	400	189	71	68	63	59	55	52	
2	550	260	70	66	61	57	53	50	
3	700	330	70	65	62	58	54	50	
4	1200	566	82	77	73	70	67	66	
5	1600	755	80	76	71	70	68	67	
6	2100	991	80	79	76	77	74	73	
7	2800	1321	79	76	73	71	68	67	

Table 6. Maximum Discharge Sound Power Levels
Full cooling (Fan on and 100% primary air)

Electric Heat

(Substitute the following paragraphs:)

1. Furnish and install series flow (constant or variable volume) fan powered terminal units with integral electric heat of the sizes and capacities as indicated on the drawings. Units shall be pressure independent with (pneumatic, analog electronic, digital electronic) controls. Units shall be manufactured by **Nailor Industries Inc. Model 35SE or 35SEST "Stealth™"** (select one).

12. An electric heater shall be factory mounted and pre-wired as an integral package with the fan powered terminal unit. Heaters shall be sized as shown on the drawings. The entire assembly including the electric heater shall be ETL listed (cETL in Canada) for zero clearance and so labeled and shall meet all requirements of the latest National Electrical Code (Canadian Electrical Code, CSA Standard C22.1). The unit with the heater mounted shall be listed and rated to be turned over for either left or right hand configuration. The unit shall have a single point electrical (and pneumatic) connection. Heater casing and panel shall be a minimum of 20 gauge galvanized steel. Each heater shall be complete with primary disc type automatic high limit, contactors as required, ground terminal, fan relay for interlocking the heater and fan and high grade nickel chrome alloy resistance wire. Element wires shall be suspended in insulators designed to expose the entire face area of the wire thereby eliminating hot spots. Each heater shall be supplied with factory supplied and pre-wired branch circuit fusing as required by NEC and UL. Circuiting and fusing shall also be in accordance with the circuiting requirements as shown on the plans. Additional accessories shall include (control transformer, circuit fusing, disconnect switch, electric step controller, pneumatic electric switches) for staging the heater.

(Additional performance requirements that you might want to include can be found in the electric heater section). The electric heater shall be located on the discharge side of the fan so as not to add heat to the motor and shorten its expected lifetime.

Heater voltage and stages to be as follows:

0 to 5.0 kW 277V/1 phase, 1 Step
5.1 kW and up 480V/3 phase, 1 Step

Hot Water Heating Coils

(Substitute the following paragraphs:)

1. Furnish and install series flow (constant or variable volume) fan powered terminal units with integral hot water coils of the sizes and capacities as indicated on the drawings. Units shall be pressure independent with (pneumatic, analog electronic, digital electronic) controls. Units shall be manufactured by **Nailor Industries Inc. Model 35SW or 35SWST "Stealth™"** (select one).

12. A hot water coil shall be factory mounted as an integral package with the fan powered terminal unit. Hot water coils shall be sized as shown on the drawings. The entire assembly including the hot water coil shall be ETL listed (cETL in Canada) for zero clearance and so labeled and shall meet all requirements of the latest National Electrical Code. The unit shall have a single point electrical (and pneumatic) connection. Water coil casing and panels shall be a minimum of 20 ga. (1.00) galvanized steel. Access panels shall be supplied on the top and bottom of the unit for easy access to the coil for inspection and cleaning. All copper, including the headers and return bends, shall be encased to eliminate heat loss during heating sequence and heat gain during cooling sequence. Coils shall be 1, 2 or 3 row as required and heating capacities shall be as shown on the plans. Coils shall

Fan Powered Terminal Units • 35S Series

Model 35S • Series Flow (Constant or Variable Volume)

OPTIONS (continued)

have aluminum plate fins spaced 10 per inch and bonded to 1/2" (13) O.D. copper tubes. Copper connections shall be sweat. All coils shall be tested at a minimum of 300 psi (2.1 MPa) under water to produce a guaranteed working pressure of 250 psi (1.7 MPa). Controls and valves for the hot water coils shall be field mounted. Heating coils shall be located on the discharge side of the fan so as not to add heat to the motor and shorten its expected lifetime.

EZvav Digital Controls

1.1 ASC VAV BACnet CONTROLLERS

A. Digital VAV Controllers shall be responsible for monitoring and controlling directly connected VAV Terminals as required. Controllers shall include fully adjustable analog outputs and digital outputs as required utilizing a proportional plus integral control loop to control damper, electric heat and hot water coils for the purpose of maintaining user setpoints. Each controller shall be classified as a native BACnet device, conforming to the BACnet Advanced Specific Controllers (B-ASC) profile, ANSI/ASHRAE BACnet Standard 135.

B. The VAV controller shall be available with integrated applications (based on model) for Single Duct, Dual Duct, and Fan Powered terminal units, including any of the following as required by the control sequence. For Single/Dual Duct terminals: Cooling Only, Cooling/Heating with Changeover and Morning Warm up. For Fan Powered terminals: Cooling with Reheat/Supplementary Heat, Heating coil operation may be with analog, floating or binary control as required.

C. The controller shall be fully configurable via the Digital Display Sensor, including communication parameters (instance, MAC, baud) and application settings (K-factor, flow limits, box configuration, reheat or fan type, default user setpoints, etc.), without any specific PC-based software. VAV controllers shall not require the use of a personal computer and PC based software and/or any interface modules.

D. The VAV controller shall be capable of being balanced from the Digital Room Sensor without any specific pc-based software.

E. The controller shall have integrated MS/TP communications. The communication port shall have network protection bulbs and integrated end-of-line (EOL) terminations.

F. The controller shall have an integrated actuator rated at 40 in-lbs. Connection to the damper shall be with a v-bolt clamp, accepting 3/8" to 5/8" damper shaft sizes. The actuator shall travel 0 to 95 degrees with adjustable end stops at 45 and 60 degrees of rotation. The actuator shall have an integrated gear disengagement mechanism.

G. The controller shall have an integrated transducer pressure sensor for airflow measurement. The sensor shall have a range of 0-2"wc, consuming and accurate to 4.5% of reading or 0.0008"wc, whichever is greater.

H. The controller shall have a Dedicated Room Sensor port for direct interface to a Digital Display Room Sensor or Discrete Room Sensor. The controller shall have the ability of detecting if a sensor has been connected to the port and identify its type, either digital display or discrete. Sensors shall be hot-swappable without powering down the controller. Sensor information via the ports shall not consume any of the devices terminated input capacity.

I. The controller shall have screw terminal blocks that can accommodate wire sizes 14-22 AWG. Terminals shall be color coded: black terminals for power, green terminals for input and outputs, and grey terminals for twisted-shielded-pair communication.

J. The power supply for the controller shall be 24 volts AC (-15%, +20%) power. Voltage below the operating range of the system shall be considered an outage.

1.2 DIGITAL ROOM SENSOR

A. The Digital Display Room Sensor (thermostat) shall provide space condition measurements and indications, including temperature and local motion/occupancy (optional), and user setpoint adjustments.

B. The Digital Room Sensor shall connect directly to the controller and shall not utilize any of the hardware I/O points of the controller. The Digital Display Room Sensor shall be able to be located up to 75' from the controller.

C. The Digital Display Room Sensor shall provide a Temporary Network Interface jack, field accessible without uninstalling the sensor, for connection to the BACnet MS/TP communication trunk to which the devices connected. The Digital Display Room Sensor, the connected controller, and all other devices on the BACnet network shall be accessible through the temporary communication jack. Microprocessor based sensors whose port only allows communication with the controller to which it is connected shall not be acceptable.

D. The Digital Display Room Sensor shall have an integrated sensor for temperature measurement as standard and a second integrated sensor for motion/occupancy (optional).

E. User/Occupant setpoints may be adjusted via the Digital Display Room Sensor.

F. The Digital Display Room Sensor shall have pre-configured menus for all control sequences allowing access to communication and application parameters.

G. The Digital Display Room Sensor shall have two levels of password protection: One level to protect user setpoint adjustment, and one level to protect configuration menu parameters. Passwords shall be at least 4 digits in length.

Fan Powered Terminal Units • 37S Series

Model 37S • Series Flow (Constant or Variable Volume) Low Profile

1. Furnish and install constant or variable volume low profile series fan powered terminal units of the sizes and capacities as indicated on the drawings. Maximum height shall be 11" (279). Units shall be pressure independent with (digital electronic, analog electronic, pneumatic) controls. Units shall be manufactured by **Nailor Industries Inc. Model 37S**.

2. The entire terminal unit shall be designed and built as a single unit. The units shall be provided with a primary variable air volume damper that controls the air quantity in response to a (pneumatic, electronic) thermostat. The space limitations shall be reviewed carefully to ensure that all units will fit into the space allowed.

3. Unit casing shall be 20 ga. (1.00) galvanized steel and 20 ga. (1.00) galvanized steel panels. Unit shall be fully lined with fiberglass insulation which shall be 1/2" (13) thick dual density insulation complying with NFPA 90 for fire and smoke resistivity and UL 181 for erosion. Any cut edges of insulation shall be coated with NFPA 90 approved sealant.

4. Unit casing shall have access panels, on the bottom and top for easy access to motor and blower assembly and for maintenance and replacement of parts without disturbing duct connections. The unit shall be rated to operate in left hand or right hand mode by turning the unit over. Access panels shall be attached to casing with (screws, quick acting latches, hinges). Casing leakage shall not exceed 2% of terminal rated airflow at 0.5" w.g. (125 Pa) interior casing pressure. All high side casing joints shall be sealed with approved sealant and high side casing leakage shall not exceed 2% of terminal rated airflow at 3" w.g. (750 Pa).

5. Units shall have round inlets for the primary air connections and shall have a 6" (152) deep inlet duct collar for field connection. The outlets shall be rectangular and suitable for flanged duct connections. Casing shall have mounting area for hanging by sheet metal straps from a concrete slab.

6. The damper shall be of rectangular, multiple inclined opposed blade construction and designed to operate on a 45° arc. Blades shall be minimum 16 ga. (1.61) galvanized steel, single thickness construction with heavy duty gasket glued to the blades. The blades shall be screwed through the damper shaft to ensure that no slippage occurs. Blade shafts shall pivot on corrosion free bearings. Damper leakage shall not exceed 2% of the terminal rated cfm at 3" w.g. (750 Pa) inlet static pressure.

7. Entire terminal unit shall be factory assembled with (pneumatic, electronic) controls. All components including all controls except the room thermostat and (pneumatic piping, field wiring) shall be factory installed and mounted with the unit.

8. Provide a (digital electronic, analog electronic, pneumatic) flow control device that will limit the maximum and minimum airflow to that scheduled on the drawings. Airflow limits shall be factory set. Thermostat signal shall reset the flow control device to adjust primary airflow to match load requirements. Control of the terminal unit shall be pressure independent.

9. The terminal unit shall be capable of operation as described herein with inlet static pressure of 0.05" w.g. (12 Pa) at full cooling with no mixing of induced and primary air. (The sequence of operation should be described here, if not part of the temperature controls specifications). Mixing of the primary and secondary airstreams shall be such that no more than 2.5°F (1.4°C) variation shall exist in the discharge airstream for each 20°F (11.1°C) of difference between the primary and secondary airstreams.

10. Blower casings shall be constructed of heavy gauge coated steel. Blower wheel shall be forward curved centrifugal type, dynamically balanced and driven by direct drive, single speed split capacitor motors. Motors shall be suitable for 120, 208, 240, or 277 volts single phase power. Motors shall have built-in overload protection, bearings capable of low rpm oiling, permanently oiled bearings and a built-in anti-backward rotation device. Fan assembly shall be mounted so as to isolate the casing from the motor and blower

vibration at no less than four points. Isolation shall be supplied at the motor and at the blower mounting points.

11. An electronic motor speed controller sized and designed for the specific blower motor combination shall be provided to allow infinitely adjustable fan speed from the minimum voltage stop to the line voltage signal to the motor. A minimum voltage stop shall be employed to ensure that fan cannot run in stall mode.

12. Units shall incorporate a single point electrical (and pneumatic) connection for the entire unit. All electrical components shall be UL or ETL listed or recognized and installed in accordance with the National Electrical Code. All electrical components shall be mounted in a control box. The entire assembly shall be ETL listed (cETL in Canada) and so labeled.

13. All sound data shall be compiled in an independent laboratory and in accordance with the latest version of AHRI Standard 880. All units shall be AHRI certified and bear the AHRI certification label.

14. Unit maximum radiated sound power levels at 1.0" w.g. (249 Pa) inlet pressure and 0.25" w.g. (63 Pa) discharge static pressure shall not exceed the values in Tables 1 and 2 at the specified airflow. No credit or reduction shall in any way be considered for room, plenum, ceiling and/or similar item effects.

Unit Size	Airflow		Sound Power Octave Band Center Frequency (Hz.)						
	cfm	l/s	2	3	4	5	6	7	
			125	250	500	1000	2000	4000	
1	300	142	60	55	50	48	45	44	
2	700	330	62	59	54	55	50	51	
3	900	425	69	62	58	58	52	53	
4	1450	684	70	66	64	60	54	52	

Table 1. Maximum Radiated Sound Power Levels Full Cooling (Fan on and 100% primary air)

Unit Size	Airflow		Sound Power Octave Band Center Frequency (Hz.)						
	cfm	l/s	2	3	4	5	6	7	
			125	250	500	1000	2000	4000	
1	300	142	56	50	46	43	34	26	
2	700	330	64	57	54	54	45	37	
3	900	425	67	59	56	56	49	40	
4	1450	684	71	63	61	57	47	39	

Table 2. Maximum Radiated Sound Power Levels Full heating (Fan only)

15. Unit maximum discharge sound power levels at 1.0" w.g. (249 Pa) inlet pressure and 0.25" w.g. (63 Pa) discharge static pressure shall not exceed the values in Table 3 at the specified airflow. No credit or reduction shall in any way be considered for room, downstream duct, elbows and/or similar item effects.

Unit Size	Airflow		Sound Power Octave Band Center Frequency (Hz.)						
	cfm	l/s	2	3	4	5	6	7	
			125	250	500	1000	2000	4000	
1	300	142	67	60	52	44	38	34	
2	700	330	66	62	59	55	51	47	
3	900	425	77	73	67	66	63	60	
4	1450	684	76	72	70	70	66	64	

Table 3. Maximum Discharge Sound Power Levels Full cooling (Fan on and 100% primary air)

Motor: ECM (Substitute the following paragraph:)

10. Blower casings shall be constructed of heavy gauge coated steel. Blower wheel shall be forward curved centrifugal type, dynamically balanced and driven by Electronically Commutated Motor(s). Motor(s) shall be suitable for 120 or 208 or 240 or 277 volt single phase power. Fan airflow volume shall be factory set. Fan assembly shall be mounted so as to isolate the casing from the motor and blower vibration at no less than four points. Isolation shall be supplied at the motor and at the blower mounting points. A gasketed backdraft damper shall be included on the fan discharge to reduce primary air leakage back into the plenum space.

Fan Powered Terminal Units • 37S Series

Model 37S • Series Flow (Constant or Variable Volume) Low Profile (continued)

OPTIONS

"STEALTH™"

(Substitute the following paragraphs:)

1. Furnish and install series flow (constant or variable volume) fan powered terminal units of the sizes and capacities as indicated on the drawings. Units shall be pressure independent with (digital electronic, analog electronic, pneumatic) controls. Units shall be manufactured by **Nailor Industries Inc. Model 37SST "Stealth™"**.

4. Unit maximum radiated sound power levels at 1.0" w.g. (249 Pa) inlet pressure and 0.25" w.g. (63 Pa) discharge static pressure shall not exceed the values in Tables 4 and 5 at the specified airflow. No credit or reduction shall in any way be considered for room, plenum, ceiling and/or similar item effects.

Unit Size	Airflow		Sound Power Octave Band Center Frequency (Hz.)						
	cfm	l/s	2	3	4	5	6	7	
			125	250	500	1000	2000	4000	
1	300	142	58	54	47	42	38	33	
2	700	330	65	60	54	52	49	46	
3	900	425	67	60	54	50	43	40	
4	1450	684	70	62	56	51	48	46	

Table 4. Maximum Radiated Sound Power Levels
Full Cooling (Fan on and 100% primary air)

Unit Size	Airflow		Sound Power Octave Band Center Frequency (Hz.)						
	cfm	l/s	2	3	4	5	6	7	
			125	250	500	1000	2000	4000	
1	300	142	55	51	44	38	33	26	
2	700	330	62	55	52	48	39	33	
3	900	425	64	58	55	53	41	34	
4	1450	684	67	58	53	49	43	36	

Table 5. Maximum Radiated Sound Power Levels
Full Heating (Fan only)

15. Unit maximum discharge sound power levels at 1.0" w.g. (249 Pa) inlet pressure and 0.25" w.g. (63 Pa) discharge static pressure shall not exceed the values in Table 6 at the specified airflow. No credit or reduction shall in any way be considered for room, downstream duct, elbows and/or similar item effects.

Unit Size	Airflow		Sound Power Octave Band Center Frequency (Hz.)						
	cfm	l/s	2	3	4	5	6	7	
			125	250	500	1000	2000	4000	
1	300	142	66	62	54	46	41	36	
2	700	330	66	62	59	55	51	46	
3	900	425	77	72	67	66	62	59	
4	1450	684	75	71	70	69	66	63	

Table 6. Maximum Discharge Sound Power Levels
Full cooling (Fan on and 100% primary air)

Electric Heat

(Substitute the following paragraphs:)

1. Furnish and install series flow (constant or variable volume) fan powered terminal units with integral electric heat of the sizes and capacities as indicated on the drawings. Units shall be pressure independent with (pneumatic, analog electronic, digital electronic) controls. Units shall be manufactured by **Nailor Industries Inc. Model 37SE or 37SEST "Stealth™"** (select one).

12. An electric heater shall be factory mounted and pre-wired as an integral package with the fan powered terminal unit. Heaters shall be sized as shown on the drawings. The entire assembly including the electric heater shall be ETL listed (cETL in Canada) for zero clearance and so labeled and shall meet all requirements of the latest National Electrical Code (Canadian Electrical Code, CSA Standard C22.1). The

unit with the heater mounted shall be listed and rated to be turned over for either left or right hand configuration. The unit shall have a single point electrical (and pneumatic) connection. Heater casing and panel shall be a minimum of 20 gauge galvanized steel. Each heater shall be complete with primary disc type automatic high limit, contactors as required, ground terminal, fan relay for interlocking the heater and fan and high grade nickel chrome alloy resistance wire. Element wires shall be suspended in insulators designed to expose the entire face area of the wire thereby eliminating hot spots. Each heater shall be supplied with factory supplied and pre-wired branch circuit fusing as required by NEC and UL. Circuiting and fusing shall also be in accordance with the circuiting requirements as shown on the plans. Additional accessories shall include (control transformer, circuit fusing, disconnect switch, electric step controller, pneumatic electric switches) for staging the heater.

(Additional performance requirements that you might want to include can be found in the electric heater section). The electric heater shall be located on the discharge side of the fan so as not to add heat to the motor and shorten its expected lifetime.

Heater voltage and stages to be as follows:

- 0 to 5.0 kW 277V/1 phase, 1 Step
- 5.1 kW and up 480V/3 phase, 1 Step

Hot Water Heating Coils

(Substitute the following paragraphs:)

1. Furnish and install series flow (constant or variable volume) fan powered terminal units with integral hot water coils of the sizes and capacities as indicated on the drawings. Units shall be pressure independent with (digital electronic, analog electronic, pneumatic) controls. Units shall be manufactured by **Nailor Industries Inc. Model 37SW or 37SWST "Stealth™"** (select one).

12. A hot water coil shall be factory mounted as an integral package with the fan powered terminal unit. Hot water coils shall be sized as shown on the drawings. The entire assembly including the hot water coil shall be ETL listed (cETL in Canada) for zero clearance and so labeled and shall meet all requirements of the latest National Electrical Code. The unit shall have a single point electrical (and pneumatic) connection. Water coil casing and panels shall be a minimum of 20 ga. (1.00) galvanized steel. Access panels shall be supplied on the top and bottom of the unit for easy access to the coil for inspection and cleaning. All copper, including the headers and return bends, shall be encased to eliminate heat loss during heating sequence and heat gain during cooling sequence. Coils shall be 1, 2 or 3 row as required and heating capacities shall be as shown on the plans. Coils shall have aluminum plate fins spaced 10 per inch and bonded to 1/2" (13) O.D. copper tubes. Copper connections shall be sweat. All coils shall be tested at a minimum of 300 psi (2.1 MPa) under water to produce a guaranteed working pressure of 250 psi (1.7 MPa). Controls and valves for the hot water coils shall be field mounted. Heating coils shall be located on the discharge side of the fan so as not to add heat to the motor and shorten its expected lifetime.

EZvav Digital Controls

1.1 ASC VAV BACnet CONTROLLERS

A. Digital VAV Controllers shall be responsible for monitoring and controlling directly connected VAV Terminals as required. Controllers shall include fully adjustable analog outputs and digital outputs as required utilizing a proportional plus integral control loop to control damper, electric heat and hot water coils for the purpose of maintaining user setpoints. Each controller shall be classified as a native BACnet device, conforming to the BACnet Advanced Specific Controllers (B-ASC) profile, ANSI/ASHRAE BACnet Standard 135.

B. The VAV controller shall be available with integrated applications (based on model) for Single Duct, Dual Duct, and Fan Powered terminal units, including any of the following as required by the control sequence. For Single/Dual Duct terminals: Cooling Only, Cooling/Heating with Changeover and Morning Warm up. For Fan Powered terminals: Cooling with Reheat/Supplementary Heat, Heating coil operation may be with analog, floating or binary control as required.

SUGGESTED SPECIFICATIONS



Fan Powered Terminal Units

37S Series

OPTIONS (continued)

C. The controller shall be fully configurable via the Digital Display Sensor, including communication parameters (instance, MAC, baud) and application settings (K-factor, flow limits, box configuration, reheat or fan type, default user setpoints, etc.), without any specific PC-based software. VAV controllers shall not require the use of a personal computer and PC based software and/or any interface modules.

D. The VAV controller shall be capable of being balanced from the Digital Room Sensor without any specific pc-based software.

E. The controller shall have integrated MS/TP communications. The communication port shall have network protection bulbs and integrated end-of-line (EOL) terminations.

F. The controller shall have an integrated actuator rated at 40 in-lbs. Connection to the damper shall be with a v-bolt clamp, accepting 3/8" to 5/8" damper shaft sizes. The actuator shall travel 0 to 95 degrees with adjustable end stops at 45 and 60 degrees of rotation. The actuator shall have an integrated gear disengagement mechanism.

G. The controller shall have an integrated transducer pressure sensor for airflow measurement. The sensor shall have a range of 0-2"wc, consuming and accurate to 4.5% of reading or 0.0008"wc, whichever is greater.

H. The controller shall have a Dedicated Room Sensor port for direct interface to a Digital Display Room Sensor or Discrete Room Sensor. The controller shall have the ability of detecting if a sensor has been connected to the port and identify its type, either digital display or discrete. Sensors shall be hot-swappable without powering down the controller. Sensor information via the ports shall not consume any of the devices terminated input capacity.

I. The controller shall have screw terminal blocks that can accommodate wire sizes 14-22 AWG. Terminals shall be color coded: black terminals for power, green terminals for input and outputs, and grey terminals for twisted-shielded-pair communication.

J. The power supply for the controller shall be 24 volts AC (-15%, +20%) power. Voltage below the operating range of the system shall be considered an outage.

1.2 DIGITAL ROOM SENSOR

A. The Digital Display Room Sensor (thermostat) shall provide space condition measurements and indications, including temperature and local motion/occupancy (optional), and user setpoint adjustments.

B. The Digital Room Sensor shall connect directly to the controller and shall not utilize any of the hardware I/O points of the controller. The Digital Display Room Sensor shall be able to be located up to 75' from the controller.

C. The Digital Display Room Sensor shall provide a Temporary Network Interface jack, field accessible without uninstalling the sensor, for connection to the BACnet MS/TP communication trunk to which the devices connected. The Digital Display Room Sensor, the connected controller, and all other devices on the BACnet network shall be accessible through the temporary communication jack. Microprocessor based sensors whose port only allows communication with the controller to which it is connected shall not be acceptable.

D. The Digital Display Room Sensor shall have an integrated sensor for temperature measurement as standard and a second integrated sensor for motion/occupancy (optional).

E. User/Occupant setpoints may be adjusted via the Digital Display Room Sensor.

F. The Digital Display Room Sensor shall have pre-configured menus for all control sequences allowing access to communication and application parameters.

G. The Digital Display Room Sensor shall have two levels of password protection: One level to protect user setpoint adjustment, and one level to protect configuration menu parameters. Passwords shall be at least 4 digits in length.

Model 35N • Parallel Flow (Variable Volume)

1. Furnish and install variable volume parallel fan powered terminal units of the sizes and capacities as indicated on the drawings. Units shall be pressure independent with (digital, analog electronic, pneumatic) controls. Units shall be manufactured by **Nailor Industries Inc. Model 35N**.

2. The entire terminal unit shall be designed and built as a single unit. The units shall be provided with a primary variable air volume damper that controls the air quantity in response to a (thermostat or digital controller/zone sensor). The units shall also include a fan that sequences on and off in response to the (thermostat or digital controller/zone sensor). The space limitations shall be reviewed carefully to ensure that all units will fit into the space allowed.

3. Unit casings shall be 20 ga. (1.00) galvanized steel. Unit shall be fully lined with fiberglass insulation which shall be at least 3/4" (19) thick dual density insulation complying with NFPA 90 for fire and smoke resistivity and UL 181 for erosion. Any cut edges of insulation shall be coated with NFPA 90 approved sealant.

4. The terminal casing shall have full size bottom access panels for easy access to motor and blower assembly and for maintenance and replacement of parts without disturbing duct connections. Access panels shall be attached to casing with (screws, 1/4 turn fasteners).

5. Units shall have round inlets for the primary air connections and shall have a minimum 6" (152) deep inlet duct collar for field connection. Models with no heat or electric heat shall have rectangular outlets suitable for flanged duct connections. Models with hot water coils shall have a discharge opening with slip and drive connection. Casing shall have mounting area for hanging by sheet metal straps from a concrete slab.

6. The damper shall be round and of laminated 2 x 20 ga. (1.00) galvanized steel construction with a peripheral gasket and a solid steel 1/2" (13) diameter shaft, pivoted in self-lubricating bronze oilite bearings. Damper leakage shall not exceed 2% of the terminal rated airflow at 3" w.g. (750 Pa) inlet static pressure.

7. Entire terminal unit shall be factory assembled with (digital, analog electronic, pneumatic) controls. All components including all controls except the room (thermostat or zone sensor) and (pneumatic piping, field wiring) shall be factory installed and mounted with the unit.

8. Provide a (digital, analog electronic, pneumatic) flow control device that will limit the maximum and minimum airflow to that scheduled on the drawings. Control of the terminal unit shall be pressure independent.

9. The sequence of operation should be described here, if not part of the temperature controls specifications.

10. Blower casings shall be constructed of heavy gauge coated steel. Blower wheel shall be forward curved centrifugal type, dynamically balanced and driven by direct drive, single speed split capacitor motors. Motors shall be suitable for 120 or 208 or 240 or 277 volt single phase power. Motors shall have built-in overload protection, bearings capable of low rpm oiling, permanently oiled bearings and a built-in, anti-backward rotation device. Fan assembly shall be mounted so as to isolate the casing from the motor and blower vibration at no less than four points. Isolation shall be supplied at the motor and at the blower mounting points. A gasketed backdraft damper shall be included on the fan discharge to preclude primary air leakage back into the plenum space.

11. A solid state SCR fan speed controller sized and designed for the specific blower motor combination shall be provided to allow infinitely adjustable fan speed from the minimum voltage stop to the line voltage signal to the motor. A minimum voltage stop shall be employed to ensure that fan cannot run in stall mode.

12. Units shall incorporate a single point electrical (and pneumatic) connection for the entire unit. All electrical components shall be ETL listed or recognized and installed in accordance with the National Electrical Code. All electrical components shall be mounted in a control box. The entire assembly shall be ETL listed and labeled to meet UL 1995 and CSA C22.2 No. 236.

Fan Powered Terminal Units • 35N Series

Model 35N • Parallel Flow (Variable Volume) (continued)

13. All sound data shall be compiled in an independent laboratory and in accordance with the latest version of AHRI Standard 880. All units shall be AHRI certified and bear the AHRI certification label.

14. Unit maximum radiated and discharge sound power levels with fan only and 0.25" w.g. (63 Pa) discharge static pressure shall not exceed the values in Tables 1 and 2 at the specified airflow. No credit or reduction shall in any way be considered for room, plenum, ceiling, downstream duct, elbows and/or similar item effects.

Unit Size	Airflow		Sound Power Octave Band Center Frequency (Hz.)						
	cfm	l/s	2	3	4	5	6	7	
			125	250	500	1000	2000	4000	
2	400	189	67	60	58	52	45	43	
3	700	330	67	61	59	55	49	45	
5	1000	472	72	63	58	54	49	46	
6	1500	708	77	67	63	61	58	55	

Table 1. Maximum Radiated Sound Power Levels Heating Cycle (Fan only)

Unit Size	Airflow		Sound Power Octave Band Center Frequency (Hz.)						
	cfm	l/s	2	3	4	5	6	7	
			125	250	500	1000	2000	4000	
2	400	189	62	55	54	50	47	46	
3	700	330	62	56	56	53	50	47	
5	1000	472	67	58	57	54	51	49	
6	1500	708	67	64	63	62	59	58	

Table 2. Maximum Discharge Sound Power Levels Heating Cycle (Fan only)

15. Unit maximum radiated and discharge sound power levels with 100% primary air and fan off at 1.0" w.g. (249 Pa) inlet pressure and 0.25" w.g. (63 Pa) discharge static pressure shall not exceed the values in Table 3 and 4 at the specified airflow. No credit or reduction shall in any way be considered for room, plenum, ceiling, downstream duct, elbows and/or similar item effects.

Unit/ Inlet Size	Airflow		Sound Power Octave Band Center Frequency (Hz.)						
	cfm	l/s	2	3	4	5	6	7	
			125	250	500	1000	2000	4000	
2	700	189	62	57	51	39	38	36	
3	1100	330	65	59	54	46	41	37	
5	1600	472	67	60	53	45	43	42	
6	2100	708	70	62	57	50	47	45	

Table 3. Maximum Radiated Sound Power Levels Cooling Cycle (100% primary air and fan off)

Unit/ Inlet Size	Airflow		Sound Power Octave Band Center Frequency (Hz.)						
	cfm	l/s	2	3	4	5	6	7	
			125	250	500	1000	2000	4000	
2	700	189	70	66	59	54	52	54	
3	1100	330	69	67	60	54	56	57	
5	1600	472	70	67	61	53	54	56	
6	2100	708	73	68	62	56	59	60	

Table 4. Maximum Discharge Sound Power Levels Cooling Cycle (100% primary air and fan off)

OPTIONS

Electric Heat

(Substitute the following paragraphs:)

1. Furnish and install variable volume parallel fan powered terminal units with integral electric heat of the sizes and capacities as indicated on the drawings. Units shall be pressure independent with (digital, analog electronic, pneumatic) controls. Units shall be manufactured by **Nailor Industries Inc.** Model **35NE**.

2. An electric heater shall be factory mounted and pre-wired as an integral package with the fan powered terminal unit. Heaters shall be sized as shown on the drawings. The entire assembly including the electric heater shall be ETL listed for zero clearance and so labeled and shall meet all requirements of the latest National Electrical Code, CSA C22.2 No.236). The unit shall have a single point electrical (and pneumatic) connection. Heater casing and panel shall be a minimum of 20 ga. (1.00) galvanized steel. Each heater shall be complete with automatic reset high limit thermal cut-outs, control voltage transformer as required, ground terminal, fan relay for interlocking the heater and fan and high grade nickel chrome alloy resistance wire.

Element wires shall be suspended in insulators designed to expose the entire face area of the wire thereby eliminating hot spots. Each heater shall be supplied with factory supplied and pre-wired branch circuit fusing as required by NEC and UL. Circuiting and fusing shall also be in accordance with the circuiting requirements as shown on the plans.

Additional accessories shall include (control transformer, circuit fusing, disconnect switch, SCR controller, pneumatic electric switches) for staging the heater. (Additional performance requirements that you might want to include can be found in the electric heater section). The electric heater shall be located on the discharge side of the fan so as not to add heat to the motor and shorten its expected lifetime.

Coils rated up through 5 kW shall be single phase, 277 volt, 60 Hz and coils larger than 5 kW shall be three phase, four wire wye, 480 volt, 60 Hz. Electric heating coils up to and including 4 kW shall be single stage. Electric coils above 4 kW shall be two stage.

Hot Water Heating Coils

(Substitute the following paragraphs:)

1. Furnish and install Variable Volume Parallel Fan Powered Terminal Units with integral hot water coils of the sizes and capacities as indicated on the drawings. Units shall be pressure independent with (digital, analog electronic, pneumatic) controls. Units shall be manufactured by **Nailor Industries Inc.** Model **35NW**.

2. A hot water coil shall be factory mounted as an integral package with the fan powered terminal unit. Hot water coils shall be sized as shown on the drawings. The entire assembly including the hot water coil shall be ETL listed for zero clearance and so labeled and shall meet all requirements of the latest National Electrical Code (CSA C22.2 No.236). The unit shall have a single point electrical (and pneumatic) connection. Access panels on the bottom of the unit shall permit easy access to the coil for inspection and cleaning. Coils shall be 1, 2 or 3 row as required and heating capacities shall be as shown on the plans. Coils shall have aluminum plate fins spaced 10 per inch and bonded to 1/2" (13) O.D. copper tubes. Copper connections shall be sweat. All coils shall be tested at a minimum of 300 psi (2.1 MPa) under water to produce a guaranteed working pressure of 250 psi (1.7 MPa). Controls and valves for the hot water coils shall be field mounted. Heating coils shall be located on the discharge side of the fan so as not to add heat to the motor and shorten its expected lifetime.

Fan Powered Terminal Units • 35N Series

Model 35N • Parallel Flow (Variable Volume)

OPTIONS (continued)

Liner Options:

(Substitute in the appropriate specification section)

Steri-Liner

Unit shall be fully lined with non-porous, sealed liner which complies with NFPA 90A & 90B, ASTM E84, UL 723, UL 181 and ASTM G21 & G22. Installation shall be 13/16" (21) minimum thickness, 4 lb. 1 cu. ft. (64 kg/m³) density with reinforced aluminum foil-scrim-kraft (FSK) facing. All cut edges shall be secured with steel angles or end caps to encapsulate edges and prevent erosion. Insulation shall be Nailor Steri-Liner or equal.

Fiber-Free Liner

Unit shall be fully lined with a non-porous closed cell elastomeric foam liner which complies with NFPA 90A & 90B, ASTM E84, UL 723, UL 181. Installation shall be 3/4" (19) minimum thickness and secured to the interior of the terminal with mechanical fasteners. No fiberglass is permitted. Insulation shall be Nailor Fiber-Free Liner or equal.

EZvav Digital Controls

1.1 ASC VAV BACnet CONTROLLERS

A. Digital VAV Controllers shall be responsible for monitoring and controlling directly connected VAV Terminals as required. Controllers shall include fully adjustable analog outputs and digital outputs as required utilizing a proportional plus integral control loop to control damper, electric heat and hot water coils for the purpose of maintaining user setpoints. Each controller shall be classified as a native BACnet device, conforming to the BACnet Advanced Specific Controllers (B-ASC) profile, ANSI/ASHRAE BACnet Standard 135.

B. The VAV controller shall be available with integrated applications (based on model) for Single Duct, Dual Duct, and Fan Powered terminal units, including any of the following as required by the control sequence. For Single/Dual Duct terminals: Cooling Only, Cooling/Heating with Changeover and Morning Warm up. For Fan Powered terminals: Cooling with Reheat/Supplementary Heat, Heating coil operation may be with analog, floating or binary control as required.

C. The controller shall be fully configurable via the Digital Display Sensor, including communication parameters (instance, MAC, baud) and application settings (K-factor, flow limits, box configuration, reheat or fan type, default user setpoints, etc.), without any specific PC-based software. VAV controllers shall not require the use of a personal computer and PC based software and/or any interface modules.

D. The VAV controller shall be capable of being balanced from the Digital Room Sensor without any specific pc-based software.

E. The controller shall have integrated MS/TP communications. The communication port shall have network protection bulbs and integrated end-of-line (EOL) terminations.

F. The controller shall have an integrated actuator rated at 40 in-lbs. Connection to the damper shall be with a v-bolt clamp, accepting 3/8" to 5/8" damper shaft sizes. The actuator shall travel 0 to 95 degrees with adjustable end stops at 45 and 60 degrees of rotation. The actuator shall have an integrated gear disengagement mechanism.

G. The controller shall have an integrated transducer pressure sensor for airflow measurement. The sensor shall have a range of 0-2"wc, consuming and accurate to 4.5% of reading or 0.0008"wc, whichever is greater.

H. The controller shall have a Dedicated Room Sensor port for direct interface to a Digital Display Room Sensor or Discrete Room Sensor. The controller shall have the ability of detecting if a sensor has been connected to the port and identify its type, either digital display or discrete. Sensors shall be hot-swappable without powering down the controller. Sensor information via the ports shall not consume any of the devices terminated input capacity.

I. The controller shall have screw terminal blocks that can accommodate wire sizes 14-22 AWG. Terminals shall be color coded: black terminals for power, green terminals for input and outputs, and grey terminals for twisted-shielded-pair communication.

J. The power supply for the controller shall be 24 volts AC (-15%, +20%) power. Voltage below the operating range of the system shall be considered an outage.

1.2 DIGITAL ROOM SENSOR

A. The Digital Display Room Sensor (thermostat) shall provide space condition measurements and indications, including temperature and local motion/occupancy (optional), and user setpoint adjustments.

B. The Digital Room Sensor shall connect directly to the controller and shall not utilize any of the hardware I/O points of the controller. The Digital Display Room Sensor shall be able to be located up to 75' from the controller.

C. The Digital Display Room Sensor shall provide a Temporary Network Interface jack, field accessible without uninstalling the sensor, for connection to the BACnet MS/TP communication trunk to which the devices connected. The Digital Display Room Sensor, the connected controller, and all other devices on the BACnet network shall be accessible through the temporary communication jack. Microprocessor based sensors whose port only allows communication with the controller to which it is connected shall not be acceptable.

D. The Digital Display Room Sensor shall have an integrated sensor for temperature measurement as standard and a second integrated sensor for motion/occupancy (optional).

E. User/Occupant setpoints may be adjusted via the Digital Display Room Sensor.

F. The Digital Display Room Sensor shall have pre-configured menus for all control sequences allowing access to communication and application parameters.

G. The Digital Display Room Sensor shall have two levels of password protection: One level to protect user setpoint adjustment, and one level to protect configuration menu parameters. Passwords shall be at least 4 digits in length.

Fan Powered Terminal Units • 37N Series

Model 37N • Parallel Flow (Variable Volume) Low Profile

1. Furnish and install **Nailor 37N Series Low Profile Variable Volume Parallel Fan Powered Terminal Units** of the sizes and capacities as indicated on the drawings. Units shall be pressure independent with (digital, analog electronic, pneumatic) controls.
2. The entire terminal unit shall be designed and built as a single unit. The units shall be provided with a primary variable air volume damper that controls the air quantity in response to a (thermostat or digital controller/zone sensor). The units shall also include a fan that sequences on and off in response to the (thermostat or digital controller/zone sensor). The space limitations shall be reviewed carefully to ensure that all units will fit into the space allowed.
3. Unit casings shall be 20 ga. (1.00) galvanized steel. Unit shall be fully lined with fiberglass insulation which shall be 1/2" (13) thick dual density insulation complying with NFPA 90 for fire and smoke resistivity and UL 181 for erosion. Any cut edges of insulation shall be coated with NFPA 90 approved sealant.
4. The terminal casing shall have full size bottom access panels for easy access to motor and blower assembly and for maintenance and replacement of parts without disturbing duct connections. Access panels shall be attached to casing with (screws, 1/4 turn fasteners).
5. Units shall have round or rectangular inlets for the primary air connections and shall have a minimum 6" (152) deep inlet duct collar for field connection. Models with no heat or electric heat shall have rectangular outlets suitable for flanged duct connections. Models with hot water coils shall have an induction inlet designed to accept flanged hot water coils. Duct connection to hot water coil shall be flanged ducts. Casing shall have mounting area for hanging by sheet metal straps from a concrete slab.
6. The damper shall be round or rectangular and constructed of laminated 20 ga. (1.00) galvanized steel with a peripheral gasket and a solid steel 1/2" (13) diameter shaft, pivoted in self-lubricating bronze oilite bearings. Damper leakage shall not exceed 2% of the terminal rated airflow at 3" w.g. (746 Pa) inlet static pressure.
7. Entire terminal unit shall be factory assembled with (pneumatic, analog electronic) controls. All components including all controls except the room (thermostat or zone sensor) and (pneumatic piping, field wiring) shall be factory installed and mounted with the unit. Digital controls shall be supplied by BAS controls contractor. Digital controls are optionally factory mounted and wired.
8. Provide a (digital, analog electronic, pneumatic) flow control device that will limit the maximum and minimum airflow to that scheduled on the drawings. Control of the terminal unit shall be pressure independent.
9. The sequence of operation should be described here, if not part of the temperature controls specifications.
10. Blower casings shall be constructed of heavy gauge coated steel. Blower wheel shall be forward curved centrifugal type, dynamically balanced and driven by direct drive, single speed split capacitor motor(s). Motor(s) shall be suitable for 120 or 208 or 240 or 277 volt single phase power. Motors shall have built-in overload protection, bearings capable of low speed oiling, permanently oiled bearings and be of an anti-backward rotation design. Fan assembly shall be mounted so as to isolate the casing from the motor and blower vibration at no less than four points. Isolation shall be supplied at the motor and at the blower mounting points. A gasketed backdraft damper shall be included on the fan discharge to reduce primary air leakage back into the plenum space.
11. A solid state SCR fan speed controller sized and designed for the specific blower motor combination shall be provided to allow infinitely adjustable fan speed from the minimum voltage stop to the line voltage signal to the motor. A minimum voltage stop shall be employed to ensure that fan cannot run in stall mode.
12. Units shall incorporate a single point electrical and/or pneumatic connection for the entire unit. All electrical components shall be ETL listed or recognized and installed in accordance with the

National Electrical Code. All electrical components shall be mounted in a control box. The entire assembly shall be ETL listed and labeled to meet UL 1995 and CSA C22.2 No. 236.

13. All sound data shall be compiled in an independent laboratory and in accordance with the latest version of AHRI Standard 880. All units shall be AHRI certified and bear the AHRI certification label.

14. Unit maximum radiated and discharge sound power levels with fan only and 0.25" w.g. (63 Pa) discharge static pressure shall not exceed the values in Tables 1 and 2 at the specified airflow. No credit or reduction shall in any way be considered for room, plenum, ceiling, downstream duct, elbows and/or similar item effects.

Unit Size	Airflow		Sound Power Octave Band Center Frequency (Hz.)						
	cfm	l/s	2	3	4	5	6	7	
			125	250	500	1000	2000	4000	
2	550	260	69	59	56	50	46	38	
3	700	330	68	60	60	55	47	38	
4	825	389	69	61	61	56	47	39	

Table 1. Maximum Radiated Sound Power Levels Heating Cycle (Fan only)

Unit Size	Airflow		Sound Power Octave Band Center Frequency (Hz.)						
	cfm	l/s	2	3	4	5	6	7	
			125	250	500	1000	2000	4000	
2	550	260	70	60	56	51	41	43	
3	700	330	71	61	60	54	47	50	
4	825	389	70	60	62	56	49	50	

Table 2. Maximum Discharge Sound Power Levels Heating Cycle (Fan only)

15. Unit maximum radiated and discharge sound power levels with 100% primary air and fan off at 1.0" w.g. (249 Pa) inlet pressure and 0.25" w.g. (63 Pa) discharge static pressure shall not exceed the values in Table 3 and 4 at the specified airflow. No credit or reduction shall in any way be considered for room, plenum, ceiling, downstream duct, elbows and/or similar item effects.

Unit/ Inlet Size	Airflow		Sound Power Octave Band Center Frequency (Hz.)						
	cfm	l/s	2	3	4	5	6	7	
			125	250	500	1000	2000	4000	
2	700	330	71	59	50	43	40	32	
3	1100	519	69	61	54	46	39	35	
4	1600	755	70	59	53	48	44	41	

Table 3. Maximum Radiated Sound Power Levels Cooling Cycle (100% primary air and fan off)

Unit/ Inlet Size	Airflow		Sound Power Octave Band Center Frequency (Hz.)						
	cfm	l/s	2	3	4	5	6	7	
			125	250	500	1000	2000	4000	
2	700	330	70	65	59	53	41	36	
3	1100	519	75	69	63	55	47	41	
4	1600	755	75	68	64	56	49	49	

Table 4. Maximum Discharge Sound Power Levels Cooling Cycle (100% primary air and fan off)

Motor:

ECM

(Substitute the following paragraph:)

10. Blower casings shall be constructed of heavy gauge coated steel. Blower wheel shall be forward curved centrifugal type, dynamically balanced and driven by Electronically Commutated Motor(s). Motor(s) shall be suitable for 120 or 208 or 240 or 277 volt single phase power. Fan airflow volume shall be factory set. Fan assembly shall be mounted so as to isolate the casing from the motor and blower vibration at no less than four points. Isolation shall be supplied at the motor and at the blower mounting points. A gasketed backdraft damper shall be included on the fan discharge to reduce primary air leakage back into the plenum space.

Fan Powered Terminal Units • 37N Series

Model 37N • Parallel Flow (Variable Volume) Low Profile (continued)

OPTIONS

Electric Heat:

Model: 37NE Staged

(Substitute the following paragraphs:)

1. Furnish and install **Nailor Model 37NE Low Profile Variable Volume Parallel Fan Powered Terminal Units** with integral electric heat of the sizes and capacities as indicated on the drawings. Units shall be pressure independent with (digital, analog electronic, pneumatic) controls.

12. An electric heater shall be factory mounted and pre-wired as an integral package with the fan powered terminal unit. Heaters shall be sized as shown on the drawings. The entire assembly including the electric heater shall be ETL listed for zero clearance and so labeled and shall meet all requirements of the latest National Electrical Code, (CSA C22.2 No.236). The unit shall have a single point electrical and/or pneumatic connection (dual point electrical on 600V). Heater casing and panel shall be a minimum of 20 ga. (1.00) galvanized steel. Each heater shall be complete with automatic reset high limit thermal cut-outs, control voltage transformer as required, ground terminal, fan relay for interlocking the heater and fan and high grade nickel chrome alloy wire.

Element wires shall be supported by ceramic isolators. Each heater shall be supplied with factory supplied and pre-wired branch circuit fusing as required by NEC and UL. Circuiting and fusing shall also be in accordance with the circuiting requirements as shown on the plans.

Additional accessories shall include (control transformer, circuit fusing, disconnect switch, pneumatic electric switches) for staging the heater.

Proportional Heat (SCR)

(Substitute the following paragraphs:)

1. Furnish and install **Nailor Model 37NE Low Profile Variable Volume Parallel Fan Powered Terminal Units** with integral electric heat of the sizes and capacities as indicated on the drawings. Units shall be pressure independent with (digital, analog electronic, pneumatic) controls.

12. An electric heater shall be factory mounted and pre-wired as an integral package with the fan powered terminal unit. Heaters shall be sized as shown on the drawings. The entire assembly including the electric heater shall be ETL listed for zero clearance and so labeled and shall meet all requirements of the latest National Electrical Code, (CSA C22.2 No.236). The unit shall have a single point electrical and/or pneumatic connection (dual point electrical on 600V). Heater casing and panel shall be a minimum of 20 ga. (1.00) galvanized steel. Each heater shall be complete with automatic reset high limit thermal cut-outs, control voltage transformer as required, ground terminal, fan relay for interlocking the heater and fan and high grade nickel chrome alloy wire.

Element wires shall be supported by ceramic isolators. Each heater shall be supplied with factory supplied and pre-wired branch circuit fusing as required by NEC and UL. Circuiting and fusing shall also be in accordance with the circuiting requirements as shown on the plans.

Additional accessories shall include (control transformer, circuit fusing, disconnect switch, pneumatic electric switches) for heater control.

Heater shall be capable of providing proportional control of heater capacity from an input signal of 4 – 20 mA, 2 – 10 VDC or 0 – 10 VDC. The SCR controller shall provide a 1 – 24 VDC pulsed output to SSR(s) [solid state relay(s)] in proportion to zone heating demand. The SSR's shall switch with zero cross over to reduce system noise and thermal shock on heater coils.

Proportional Heat with Discharge Temperature Control (DTC)

(Substitute the following paragraphs:)

1. Furnish and install **Nailor Model 37NE Low Profile Variable Volume Parallel Fan Powered Terminal Units** with integral electric heat of the sizes and capacities as indicated on the drawings. Units shall be pressure independent with (digital, analog electronic, pneumatic) controls.

12. An electric heater shall be factory mounted and pre-wired as an integral package with the fan powered terminal unit. Heaters shall be sized as shown on the drawings. The entire assembly including the electric heater shall be ETL listed for zero clearance and so labeled and shall meet all requirements of the latest National Electrical Code, (CSA C22.2 No.236). The unit shall have a single point electrical and/or pneumatic connection (dual point electrical on 600V). Heater casing and panel shall be a minimum of 20 ga. (1.00) galvanized steel. Each heater shall be complete with automatic reset high limit thermal cut-outs, control voltage transformer as required, ground terminal, fan relay for interlocking the heater and fan and high grade nickel chrome alloy wire.

Element wires shall be supported by ceramic isolators. Each heater shall be supplied with factory supplied and pre-wired branch circuit fusing as required by NEC and UL. Circuiting and fusing shall also be in accordance with the circuiting requirements as shown on the plans.

Additional accessories shall include (control transformer, circuit fusing, disconnect switch, pneumatic electric switches) for heater control.

The SCR controller shall contain a discharge temperature sensor capable of limiting leaving air temperature to a user defined setpoint. The SCR controller shall pulse the coil to maintain zone demand while providing the set maximum discharge air temperature. Upon measuring a discharge air temperature above the user defined setpoint, the controller shall reduce heater capacity to maintain maximum allowable discharge air temperature. The discharge air temperature setpoint shall be adjustable from 80 – 100°F (27 – 149°C) by use of a controller mounted potentiometer.

Hot Water Heating Coils:

Model: 37NW

(Substitute the following paragraphs:)

1. Furnish and install **Nailor Model 37NW Low Profile Variable Volume Parallel Fan Powered Terminal Units** with integral hot water coils of the sizes and capacities as indicated on the drawings. Units shall be pressure independent with (digital, analog electronic, pneumatic) controls.

12. A hot water coil shall be factory mounted as an integral package with the fan powered terminal unit. Hot water coils shall be sized as shown on the drawings. The entire assembly including the hot water coil shall be ETL listed, labeled and shall meet all requirements of the latest National Electrical Code (CSA C22.2 No.236). The unit shall have a single point electrical and/or pneumatic connection. Access panels on the bottom of the unit shall permit easy access to the coil for inspection and cleaning. Coils shall be 1 or 2 row as required and heating capacities shall be as shown on the plans. Coils shall have aluminum plate fins spaced 10 per inch and bonded to 1/2" (13) O.D. copper tubes. Copper connections shall be sweat. All coils shall be tested at a minimum of 350 psi (2.4 MPa) under water to produce a guaranteed working pressure of 300 psi (2.1 MPa). Controls and valves for the hot water coils shall be field mounted. Heating coils shall be located on the induction side of the fan.

Fan Powered Terminal Units • 37N Series

Model 37N • Parallel Flow (Variable Volume) Low Profile

OPTIONS (continued)

Liner: Steri-Liner

(Substitute the following paragraph:)

3. Unit casings shall be 20 ga. (1.00) galvanized steel. Unit shall be fully lined with non-porous, sealed liner which complies with NFPA 90A & 90B, ASTM E84, UL 723, UL 181 and ASTM G21 & G22. Installation shall be 1/2" (13) minimum thickness, 4 lb./cu. ft. (64 kg/m³) density with reinforced aluminum foil-scrim-kraft (FSK) facing. All cut edges shall be secured with steel angles or end caps to encapsulate edges and prevent erosion. Insulation shall be Nailor Steri-Liner or equal.

Fiber-Free Liner

(Substitute the following paragraph:)

3. Unit casings shall be 20 ga. (1.00) galvanized steel. Unit shall be fully lined with a non-porous closed cell elastomeric foam liner which complies with NFPA 90A & 90B, ASTM E84, UL 723 and UL 181. Installation shall be 3/8" (10) minimum thickness and secured to the interior of the terminal with mechanical fasteners. No fiberglass is permitted. Insulation shall be Nailor Fiber-Free Liner or equal.

EZvav Digital Controls

1.1 ASC VAV BACnet CONTROLLERS

A. Digital VAV Controllers shall be responsible for monitoring and controlling directly connected VAV Terminals as required. Controllers shall include fully adjustable analog outputs and digital outputs as required utilizing a proportional plus integral control loop to control damper, electric heat and hot water coils for the purpose of maintaining user setpoints. Each controller shall be classified as a native BACnet device, conforming to the BACnet Advanced Specific Controllers (B-ASC) profile, ANSI/ASHRAE BACnet Standard 135.

B. The VAV controller shall be available with integrated applications (based on model) for Single Duct, Dual Duct, and Fan Powered terminal units, including any of the following as required by the control sequence. For Single/Dual Duct terminals: Cooling Only, Cooling/Heating with Changeover and Morning Warm up. For Fan Powered terminals: Cooling with Reheat/Supplementary Heat, Heating coil operation may be with analog, floating or binary control as required.

C. The controller shall be fully configurable via the Digital Display Sensor, including communication parameters (instance, MAC, baud) and application settings (K-factor, flow limits, box configuration, reheat or fan type, default user setpoints, etc.), without any specific PC-based software. VAV controllers shall not require the use of a personal computer and PC based software and/or any interface modules.

D. The VAV controller shall be capable of being balanced from the Digital Room Sensor without any specific pc-based software.

E. The controller shall have integrated MS/TP communications. The communication port shall have network protection bulbs and integrated end-of-line (EOL) terminations.

F. The controller shall have an integrated actuator rated at 40 in-lbs. Connection to the damper shall be with a v-bolt clamp, accepting 3/8(B-ASC)" to 5/8(B-ASC)" damper shaft sizes. The actuator shall travel 0 to 95 degrees with adjustable end stops at 45 and 60 degrees of rotation. The actuator shall have an integrated gear disengagement mechanism.

G. The controller shall have an integrated transducer pressure sensor for airflow measurement. The sensor shall have a range or 0-2(B-ASC)"wc, consuming and accurate to 4.5% of reading or 0.0008(B-ASC)"wc, whichever is greater.

H. The controller shall have a Dedicated Room Sensor port for direct interface to a Digital Display Room Sensor or Discrete Room Sensor. The controller shall have the ability of detecting if a sensor has been connected to the port and identify its type, either digital display or discrete. Sensors shall be hot-swappable without powering down the controller. Sensor information via the ports shall not consume any of the devices terminated input capacity.

I. The controller shall have screw terminal blocks that can accommodate wire sizes 14-22 AWG. Terminals shall be color coded: black terminals for power, green terminals for input and outputs, and grey terminals for twisted-shielded-pair communication.

J. The power supply for the controller shall be 24 volts AC (-15%, +20%) power. Voltage below the operating range of the system shall be considered an outage.

1.2 DIGITAL ROOM SENSOR

A. The Digital Display Room Sensor (thermostat) shall provide space condition measurements and indications, including temperature and local motion/occupancy (optional), and user setpoint adjustments.

B. The Digital Room Sensor shall connect directly to the controller and shall not utilize any of the hardware I/O points of the controller. The Digital Display Room Sensor shall be able to be located up to 75' from the controller.

C. The Digital Display Room Sensor shall provide a Temporary Network Interface jack, field accessible without uninstalling the sensor, for connection to the BACnet MS/TP communication trunk to which the devices connected. The Digital Display Room Sensor, the connected controller, and all other devices on the BACnet network shall be accessible through the temporary communication jack. Microprocessor based sensors whose port only allows communication with the controller to which it is connected shall not be acceptable.

D. The Digital Display Room Sensor shall have an integrated sensor for temperature measurement as standard and a second integrated sensor for motion/occupancy (optional).

E. User/Occupant setpoints may be adjusted via the Digital Display Room Sensor.

F. The Digital Display Room Sensor shall have pre-configured menus for all control sequences allowing access to communication and application parameters.

G. The Digital Display Room Sensor shall have two levels of password protection: One level to protect user setpoint adjustment, and one level to protect configuration menu parameters. Passwords shall be at least 4 digits in length.

Suggested Specifications • 36VR Series

Model 36VRR • Basic Unit

1. Furnish and install **Nailor Model 36VRR Round External Duct Retrofit Terminal Unit** of the sizes and capabilities as indicated on the drawings. Units shall be pressure independent with (DDC, electronic, analog electronic, pneumatic) controls. Units shall reset to any flow between minimum and the maximum cataloged airflow as allowed by the specific controller.
2. The entire terminal unit shall be designed and built as a single unit. The unit shall be provided with a variable air volume damper that controls the air quantity in response to a (DDC, analog electronic or pneumatic) control signal. The unit shall also include all options such as control enclosure, transformer and toggle disconnect. The space limitations shall be reviewed carefully to insure that all units will fit into the space allowed.
3. Unit casings on sizes 4 through 12 shall be constructed of 22 ga. (.86) rolled galvanized steel with integral concentric stiffening beads. Unit sizes 14 and 16 shall be constructed of 20 ga. (1.00) rolled galvanized steel with integral concentric stiffening beads. Units shall be a minimum of 18" (457) in length. Length of the unit varies with size, not to exceed 22" (559) in length.
4. The damper shall be round and of laminated 2 x 20 ga. (1.00) galvanized steel construction with a polyurethane peripheral gasket and a solid steel 1/2" (13) diameter shaft, pivoted in corrosion free Celcon® bearings. Dampers shall be screwed through the shaft to insure that no slippage occurs. Damper leakage shall not exceed 2% of the terminal rated airflow at 3" w.g. (750 Pa) inlet static pressure as rated by ASHRAE standard 130.
5. Unit side mounting plate shall be constructed of 22 ga. (.86) galvanized steel and shall not be secured to casing with mechanical fasteners. Control enclosures, provided standard with Nailor mounted controls, shall meet the requirements of NEMA 1 classification and be fabricated of 22 ga. (.86) galvanized steel. The control enclosures shall not be secured to the mounting plate by the use of mechanical fasteners.
6. The terminal unit shall be capable of operation as described herein with a minimum inlet static pressure that shall not exceed .32" w.g. (80 Pa). (The sequence of operations should be described here, if not part of the controls specifications.) Each unit shall be complete with factory mounted (DDC, analog electronic or pneumatic) controls. Each unit shall be supplied with an aluminum multi-point averaging sensor. Gauge tap ports shall be supplied in the piping between the sensor and the controller.
7. Each unit shall be constructed with single point electrical or pneumatic connection. All electrical components shall be ETL or UL listed or recognized and installed in accordance with the National Electrical Code. All electrical components shall be installed in a control enclosure. The entire assembly shall be ETL listed and so labeled.
8. All sound data shall be compiled in an independent laboratory and in accordance with the latest version of AHRI Standard 880 and ANSI/ASHRAE Standard 130. Tabulated NC levels shall be calculated and presented in accordance with latest edition of AHRI Standard 885.

OPTIONS

Stainless Steel Construction:

(Substitute the following paragraphs:)

3. Unit casings on sizes 4 through 12 shall be constructed of 22 ga. (.86) rolled 304/316 [select one] stainless steel with integral concentric stiffening beads. Unit sizes 14 and 16 shall be constructed of 20 ga. (1.00) rolled 304/316 [select one] stainless steel with integral concentric stiffening beads. Units shall be a minimum of 18" (457) in length. Length of the unit varies with size, not to exceed 22" (559) in length.
4. The damper shall be round and of laminated 2 x 20 ga. (1.00) 304/316 [select one] stainless steel construction with a polyurethane peripheral gasket and a solid stainless steel 1/2" (13) diameter shaft, pivoted in corrosion free Celcon® bearings. Dampers shall be screwed through the shaft to insure that no slippage occurs. Damper leakage shall not exceed 2% of the terminal rated airflow at 3" w.g. (750 Pa) inlet static pressure as rated by ASHRAE standard 130.
5. Unit side mounting plate shall be constructed of 22 ga. (.86) 304/316 [select one] stainless steel and shall not be secured to casing with mechanical fasteners. Control enclosures, provided standard with Nailor mounted controls, shall meet the requirements of NEMA 1 classification and be fabricated of 22 ga. (.86) 304/316 [select one] stainless steel. The control enclosures shall not be secured to the mounting plate by the use of mechanical fasteners.
6. The terminal unit shall be capable of operation as described herein with a minimum inlet static pressure that shall not exceed .32" w.g. (80 Pa). (The sequence of operations should be described here, if not part of the controls specifications.) Each unit shall be complete with factory mounted (DDC, electronic, analog electronic or pneumatic) controls. Each unit shall be supplied with a stainless steel multi-point averaging sensor. Gauge tap ports shall be supplied in the piping between the sensor and the controller.

Control Transformer:

[Add the following paragraph(s):]

- Provide a 120 VAC or 208 VAC or 240 VAC or 277 VAC or 480 VAC or 600 VAC or 24/24 Isolation VAC control power transformer with an integral or separately mounted primary and/or secondary overcurrent protection device in accordance with NEC requirements.

Disconnect Switch:

[Add the following paragraph(s):]

- A 2-position, toggle type, disconnect switch shall be installed, labeled and rated to disconnect line voltage from the terminal unit.

Suggested Specifications

36VR Series

Model 36VRS • Basic Unit

1. Furnish and install **Nailor 36VRS Series Slide-In Retrofit Terminal Unit** of the sizes and capabilities as indicated on the drawings. Units shall be pressure independent with (DDC, analog electronic, pneumatic) controls. Units shall reset to any flow between minimum and the maximum cataloged airflow as allowed by the specific controller.
2. The entire terminal unit shall be designed and built as a single unit. The unit shall be provided with a variable air volume damper that controls the air quantity in response to a (DDC, analog electronic or pneumatic) control signal. The unit shall also include all options such as control enclosure, transformer and toggle disconnect. The space limitations shall be reviewed carefully to insure that all units will fit into the space allowed.
3. Damper assemblies of 16 ga. (1.6) galvanized steel shall be multiple opposed blade construction and arranged to close at 45 degrees from full open to minimize air turbulence and provide near linear operation. Damper blades shall be fitted with flexible seals for tight closure and minimized sound generation. Damper blades shall be screwed through ½" (13) plated solid steel shaft(s) to insure that no slippage occurs. Blade shafts shall pivot on corrosion free Celcon® bearings. In the fully closed position, air leakage past the closed damper shall not exceed 2% of the nominal catalog rating at 3" w.g. (746 Pa) inlet static pressure as rated by ASHRAE Standard 130.
4. Unit side mounting plate shall be constructed of 22 ga. (.86) galvanized steel and contain overlap flanges, top and bottom, to interface with ductwork. Control enclosures, provided standard with Nailor mounted controls, shall meet the requirements of NEMA 1 classification and be fabricated of 22 ga. (.86) galvanized steel.
5. The terminal units shall be capable of operation as described herein with a minimum inlet static pressure that shall not exceed .43" w.g. (107 Pa). (The sequence of operations should be described here, if not part of the controls specifications.) Each unit shall be complete with factory mounted (DDC, analog electronic or pneumatic) controls. Gauge tap ports shall be supplied in the piping between the flow pick up and the controller.
6. Each unit shall be constructed with single point electrical or pneumatic connection. All electrical components shall be ETL or UL listed or recognized and installed in accordance with the National Electrical Code. All electrical components shall be installed in a control enclosure. The entire assembly shall be ETL listed and so labeled.
7. All sound data shall be compiled in an independent laboratory and in accordance with the latest version of AHRI Standard 880 and ANSI/ASHRAE Standard 130. Tabulated NC levels shall be calculated and presented in accordance with latest edition of AHRI Standard 885.
8. The Slide-In Retrofit terminal unit shall be fully gasketed to provide a seal between terminal unit and ductwork.

OPTIONS

[Add the following paragraph(s):]

Control Transformer:

- Provide a 120 VAC or 208 VAC or 240 VAC or 277 VAC or 480 VAC or 600 VAC or 24/24 Isolation VAC control power transformer with an integral or separately mounted primary and/or secondary overcurrent protection device in accordance with NEC requirements.

Disconnect Switch:

- A 2-position, toggle type, disconnect switch shall be installed, labeled and rated to disconnect line voltage from the terminal unit.

3400 Series

Model 3400 • Basic Unit

General Information

Provide 3400 Series variable air volume bypass terminal units as manufactured by Nailor Industries. Performance and capacities shall be as scheduled on the drawings.

Construction

Unit casing shall be constructed of 22 ga. (0.86) zinc coated steel, acoustically and thermally lined with 3/4" (19) dual density insulation which meets the requirements of Standard NFPA 90A and UL 181. Units shall incorporate a heavy duty steel cylindrical flow diverter valve. Single blade pivoting dampers are not acceptable.

Units shall include integral inlet and bypass balancing dampers for field adjustment as standard components. Static pressure taps shall be provided to facilitate balancing.

Analog Electronic Controls

Units shall be provided with a modulating electronic control package. The 24 volt reversible actuator shall be factory mounted direct to the damper shaft and shall include an adjustable minimum air volume end stop as a standard feature.

The 24 volt modulating electronic thermostat for field mounting shall be supplied with a (°C) (°F) temperature scale. The thermostat shall be suitable for vertical wall mounting.

The thermostat shall be microprocessor based and provide proportional plus integral control of airflow and reheat when specified.

A 115 to 24 volt 20 VA transformer shall be provided, complete with all necessary hardware for field mounting.

A changeover thermistor shall be provided with control packages designed to control both heating and cooling supply air.

Pneumatic Controls

The control sequence shall be Direct acting (normally closed damper) or Reverse acting (normally open damper). All pneumatic actuators shall be furnished and factory installed by Nailor.

Water Reheat Coils

Hot water reheat units as scheduled shall include 1-row and/or 2-row coils. Coil capacities shall be as scheduled. A low-leakage access door shall be provided to allow cleaning and inspection of the coil. Coils shall be factory mounted on the discharge of the unit with slip and drive connections.

The coils shall be aluminum plate fin with copper tubes and sweat connections. Coil connections shall be right hand or left hand as detailed on drawings. Control valves, automatic air vents and drain vents, if required, shall be supplied and field installed by others.

Electric Reheat Coils

Electric reheat coils shall be ETL listed. They shall be factory mounted on the unit discharge in an extended attenuation section. Heating capacities and control components shall be as scheduled on the drawings.



ENGINEERING GUIDE & INDEX

TABLE OF CONTENTS

Page No.

System Selection	H3
Types of Terminal Units	H5
Introduction to Variable Air Volume Terminal Controls	H9
Types of Controls	H11
Controls Terminology	H12
Features of Series and Parallel Flow Fan Powered Terminal Units	H14
Fan Selection and Fan Flow Control on Fan Powered Terminals	H17
Sizing Fan Powered Terminals	H19
Terminal Installation and Application Precautions	H22
Estimating Sound Levels	H25
Acoustic Design and Installation Considerations	H32
Performance Data Explanation	H33
Useful Formulas and Definitions	H35
Imperial/Metric Conversion Factors	H36
Pressure Measurement	H37
Velocity Pressure Chart	H38
Index	H39

System Selection

Designers have various systems to choose from when designing a building. Choosing which one to use is not always easy. The owners' needs must be met for installation, application and cost of operation. The designer must consider performance, capacity, reliability and spatial requirements and restrictions. The following guidelines describe different types of equipment and their general uses, restrictions and limitations.

Building Use

The designer must consider the intended building use as he begins to consider the type of equipment he will use. Office buildings with daily operational schedules frequently use fan powered terminal units. Usually fan powered terminals with auxiliary heaters (supplementary heat) would be used in the perimeter zones. These terminal units allow the greatest flexibility for individual zones while also allowing the central system to be turned off during unoccupied periods. During the unoccupied periods, the fan powered terminal units maintain the minimum or set back temperature levels without the help of the central air conditioning equipment.

Building Size

In large buildings, the central air handlers deliver large quantities of air to many zones with different needs. This is a perfect application for fan powered terminal units. Interior zones may not require heat at all; therefore they can be served either by single duct units or fan powered units with no supplemental heat. Unless the building is located in a tropical climate, the perimeter zones will require some type of heat, either electric or hot water. These are usually included with the terminal units, but sometimes baseboard heat is used. Buildings where the owner desires low operating costs usually employ series type fan powered terminal units, and the static pressure in the ducts is lowered to 0.5" w.g. (125 Pa) or less at the highest points. Interior zones in these buildings would require fan powered terminal units. Buildings with parallel type fan powered terminal units usually employ single duct units in the interior zones.

In shopping malls and other low rise buildings where each tenant area is small and in very small buildings, it is common to use small constant volume package air conditioners. If terminal units are employed on these systems, bypass units have traditionally been a common selection. A variation of this system uses single duct units or VAV diffusers with a main bypass damper in the supply duct. The bypass damper is regulated by the static pressure in the supply duct and relieves system pressure by opening to a return duct on ceiling return plenum. A nearly constant pressure can be maintained allowing the package units to operate at constant volume and the individual zones to be pressure dependent VAV.

Acoustical Constraints

Broadcast studios, theaters, and libraries require very low noise levels. Equipment selection and location is important here. If fan powered terminal units are to be used, careful examination of the equipment sound performance is imperative. RFI and EMI should also be considered when designing television studios.

Environmental Factors

Environmental factors include the climate and air conditions inside as well as outside the building. They also include legislative requirements such as outside air ventilation rates and local building codes. If high ventilation rates are required in interior zones, reheat will be required. In laboratories where high ventilation rates exist when multiple hoods are open, reheat is required. In zones where the load changes significantly during the day such as exterior zones in high rise office buildings that are affected by the season, solar loads and occupancy, fan powered terminal units are ideal. Single duct terminal units are usually employed where the load is usually stable.

Contamination Considerations

Hospitals, clean rooms and laboratories pose special problems. Operating rooms, bone marrow transplant, AIDS patient areas and clean rooms require positive pressurized environments. In addition to the pressure requirements, reheat coils and exposed fiberglass are usually avoided to eliminate the possibility of microbial growth in hospitals. Hospital rooms and clean rooms frequently also require constant and high ventilation rates which tend to favor dual duct terminal units. Patient housing for highly contagious diseases, such as tuberculosis, require negative pressure within the rooms to avoid allowing the germs to escape. Laboratories handling hazardous materials also require negative pressure areas. Single duct and dual duct constant volume terminal units have been usually selected for this type of building. New pressure independent ECM motor technology has led to the development of fan powered pressurization units also for these applications.

Maintenance and Accessibility

Certain types of buildings such as clean rooms require high levels of reliability from terminal units due to the difficulty and cost associated with servicing or maintaining the equipment. In a clean room, for example, if the ceiling must be opened, the space may require disinfection before it can be used again. Associated costs would include lost production time as well as the cost for disinfecting the room. In cases like these, the equipment should be located outside of the clean room space or highly reliable, low maintenance equipment should be used.

Cost Factors

Costs must be considered before the final system selection is made. Installation, operation and maintenance all contribute to total cost. Sometimes one of these costs is more important than others. For example, if the owner/builder sells the building before construction begins, then his main concern will be construction costs, and operating costs will be unimportant. If the tenants pay their own utilities, operating costs are not a concern to the developer/builder. Electric heaters usually have a lower installed cost than hot water coils, but they may have a higher operating cost. Local rates will have to be researched to arrive at the correct decision before making the final selection.

System Selection (continued)

The following table presents a summary of the different types of terminal units currently available and their suitability for particular commercial building applications.

Terminal Type	Facility Type												
	Office Space, Educational & Institutional Buildings				Hospitals, Clean Rooms & Laboratories*			Noise Sensitive Applications #			Other Facilities		
	Large Building		Small Building		Patient Areas	Operating Areas	Laboratory Space	Broadcast Studios	Theaters	Libraries	Public Use	Shopping Centers	Hotels, Multi-Residential
	Interior Zone	Exterior Zone	Interior Zone	Exterior Zone									
Single Duct													
VAV Without Reheat	👍	👍	👍	👍	👍	👎	👍	👍	👍	👍	👍	👍	👍
VAV With Reheat	👍	👍	👍	👍	👍	👎	👍	👍	👍	👍	👍	👍	👍
Dual Duct													
VAV No Mixing	👎	👎	👎	👎	👎	👎	👎	👍	👍	👍	👍	👎	👎
VAV With Mixing	👎	👎	👎	👎	👍	👍	👎	👍	👍	👍	👍	👎	👎
Constant Volume	👎	👎	👎	👎	👎	👎	👍	👎	👍	👍	👍	👎	👎
Fan Powered													
Parallel With Heat	👎	👍	👎	👍	👎	👎	👎	👎	👍	👍	👍	👍	👍
Series Without Heat	👍	👍	👍	👍	👍	👎	👎	👎	👍	👍	👍	👍	👍
Series With Heat	👍	👎	👍	👎	👍	👎	👎	👎	👍	👍	👍	👍	👍
Low Temperature	👍	👎	👍	👎	👍	👎	👎	👎	👍	👍	👍	👍	👍
Bypass	👍	👍	👍	👍	👍	👍	👍	👍	👍	👍	👍	👍	👍

Table 1.

👍 = Preferred for this application.

👎 = Sometimes used for this application.

👎 = Not recommended for this application.

* = Sealed lining is recommended to minimize entrainment of airborne fibers into the occupied spaces.

= Special consideration should be given to selecting very quiet operating equipment and use of attenuators or silencers.

Types of Terminal Units

All of the terminal units described below share several common components; corrosion resistant zinc coated steel casing, sound absorbing internal insulation with coated edges and an erosion resistant facing and a throttling damper to control conditioned air. Associated controls may be pneumatic, analog electronic or digital.

Single Duct

Description

Basic unit consists of a damper, actuator, flow sensor and selected controls. Accessory discharge attenuators and multiple outlet attenuators are also frequently used.

Operation

The terminal resets the volume (variable air volume) of conditioned air delivery to the space in response to the room thermostat. The terminal can handle hot or cold air. Occasionally, the terminal is used to control both hot and cold air, where a dual function thermostat and inlet temperature sensing with change-over controls are utilized.

Common Applications

Interior zones of a building which have a permanent cooling load and therefore no heating requirement.

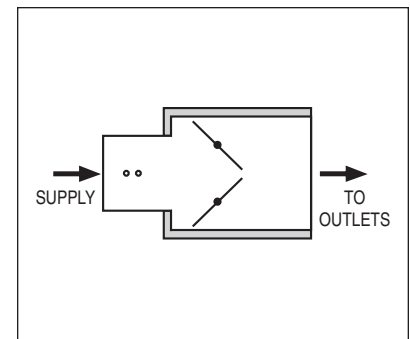

Figure 1. Single Duct (Elevation)

Single Duct with Reheat

Description

Basic unit consists of a damper, actuator, flow sensor and selected controls as above with the addition of a heating coil (hot water or electric). Accessory discharge attenuators and controlled outlet attenuators are also frequently used.

Operation

The terminal resets the volume of conditioned cold air delivery to the space in response to the room thermostat. Upon a call for heat in the space the heating coil is energized and reheats the conditioned air. Electric coils are activated in stages upon thermostat demand and water coils are modulated using a proportional or two position on/off hot water valve.

Common Applications

1. Exterior zones (adjacent to outside walls or the upper floor in the case of multi-story buildings) where convective and radiated heat losses create an intermittent need for moderate heating as the terminal usually reheats at the minimum setting. An auxiliary higher minimum setting is available as an option with additional controls.
2. Interior zones where ventilation requirements preclude full shut-off of the terminal or minimum airflow requires some added heat.

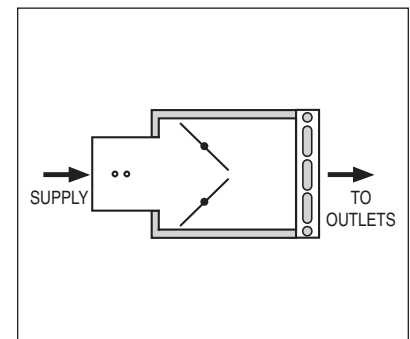

Figure 2. Single Duct with Heating Coil (Elevation)

Dual Duct (Non-mixing)

Description

Essentially two single duct boxes side-by-side. Basic unit incorporates separate cold and hot air inlets and volume control assemblies consisting of a damper, actuator, flow sensor and selected controls.

Operation

The terminal unit resets the volume flow of either hot or cold air (without mixing) to the space in response to the room thermostat. Air is supplied from a dual duct central air handling unit. There is no provision for mixing and therefore hot and cold air should not be supplied simultaneously as stratification in the discharge duct will occur, causing uneven temperature discharge from outlets.

Common Applications

Exterior zones in buildings (such as hospitals) where overhead heating and cooling is desired but use of auxiliary hot water coils is not feasible and zero to low minimum flow is acceptable during changeover.

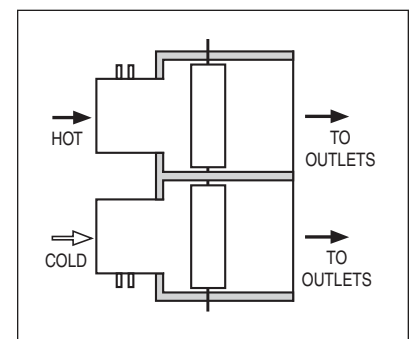

Figure 3. Dual Duct, Non-mixing (Plan View)

Dual Duct (Mixing)

Description

Basic unit incorporates separate cold and hot air inlets and volume control assemblies consisting of a damper, actuator, flow sensor and selected controls, and a common mixing/attenuator section which minimizes stratification of the discharge airstream.

Operation

The terminal unit resets the volume flow of the hot and cold air supply ducts in response to the room thermostat. Airflow delivery to the space may be variable volume (with a minimum flow established through a mixing of the two airstreams) or constant volume.

Common Applications

Interior and exterior zones in buildings (such as hospitals) where overhead heating and cooling is desired but use of an auxiliary heat coil is not feasible.

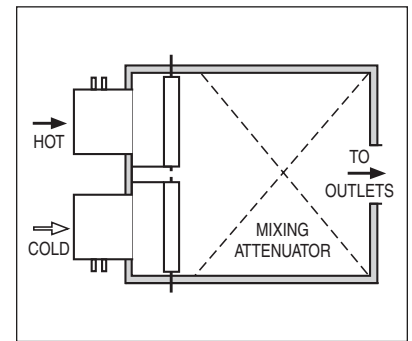

Figure 4. Dual Duct, Mixing (Plan View)

Fan Powered Series Flow (Constant or Variable Volume)

Description

Basic unit consists of a primary air damper, actuator, flow sensor, blower/motor (with flow adjustment), and selected controls. Accessory heating coils either hot water or electric are also generally required.

Operation

The primary air damper throttles conditioned cold air in response to the room thermostat and delivers this air stream to the mixing chamber upstream of the blower/motor located in series with the primary airflow. The blower/motor then delivers air to the space. Upon demand for maximum cooling, the airflow is derived entirely from the conditioned air supply. As the cooling demand diminishes, the primary damper reduces the conditioned air supply and the blower/motor compensates for this reduction by inducing make-up quantities of plenum air from the ceiling plenum thereby reclaiming otherwise wasted heat and mixing it with the conditioned air to maintain a constant volume variable temperature delivery of air to the space. Upon further reductions in space temperature, the supplemental heating coil is energized. The result is an economical volume of air diffusion to the space while the central system encounters a variable volume distribution system.

Common Applications

1. Exterior zones where heating and cooling loads may vary considerably and occupancy variances allow the central system to be shut-down or set-back during unoccupied hours.
2. Situations where central system economy is desired as central fans can be reduced in size because they only need to provide sufficient static to deliver air to the terminal.
3. Where occupant comfort is very important since the constant volume air variable temperature delivery produces optimal air distribution and optimum ventilation.

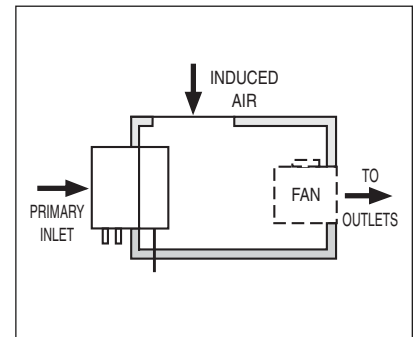

Figure 5a. Fan Powered, Series (Constant or Variable Volume) (Plan View)

Fan Powered "STEALTH™" High Performance Extra Quiet Series Flow (Constant or Variable Volume)

Description

A terminal similar to above, but incorporating special design and construction features that provide unusually quiet operation.

Operation

As described on page above.

Common Applications

As described above, but premium performance and high quality construction are ideally suited to high profile design projects and applications requiring minimum noise. Especially suitable for larger zones than standard series flow fan powered terminal units, as reduced radiated sound levels can lower first cost.

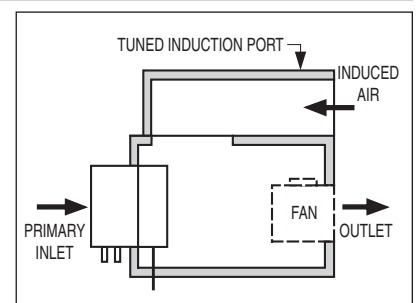

Figure 5b. Fan Powered, "STEALTH™" Series (Constant or Variable Volume) (Plan View)

Low Profile Fan Powered Series Flow (Constant or Variable Volume)

Description

Similar in construction to the standard series flow terminal described earlier, but only 11" (279) in height for all sizes, to minimize the depth of ceiling space required. Unlike standard fan powered terminals, the fan/motor assembly is installed flat on its side as shown in the diagram. Sound power levels are somewhat higher than standard units. **A "Stealth"™ model is also available from Nailor.**

Operation

As described on page H6.

Common Applications

As described on page H6. Where zoning requirements limit building height and the architect wishes to maximize the number of floors, these units will fit in a shallow ceiling plenum as small as 12" (305) deep.

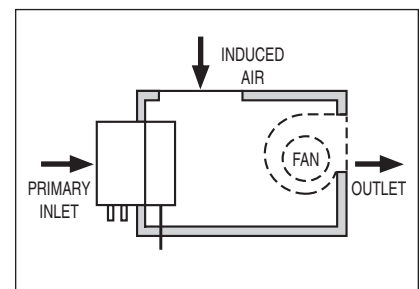

Figure 6. Low Profile Fan Powered, Series Flow (Plan View)

Outside Air Inlet Fan Powered Series Flow (Constant Volume)

Description

Similar in construction to the standard series flow terminal described earlier, but with the addition of a secondary air inlet that provides a direct connection for outside air. **A "Stealth"™ model is also available from Nailor.**

Operation

As described on page H6. The second air inlet, which is usually smaller than the primary air inlet, provides a constant volume of outside air to the zone, ensuring the minimum ventilation air requirements are met.

Common Applications

General building applications described on page H6 where maintenance and assurance of high Indoor Air Quality (IAQ) standards are a prime concern e.g. schools.

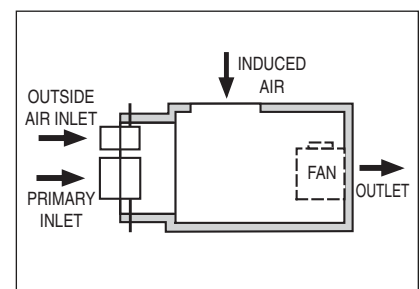

Figure 7. Outside Air Inlet Fan Powered, Series (Plan View)

Low Temperature Fan Powered Series Flow (Constant or Variable Volume)

Description

Same as Fan Powered Series (Constant Volume) with the addition of a special vapor barrier lining and a thermally isolated inlet collar to prevent condensation for use with "cold air" systems.

Operation

Same as Fan Powered Series (Constant Volume) description above.

The maximum cold air volume is established lower than the fan delivery volume in order to maintain the minimal mixing required to raise and temper the unit discharge air temperature to a level acceptable for introduction to the occupied space, usually 55°F (13°C), with standard air outlets and to maintain ceiling coanda effect.

Common Applications

This unit is used with chilled water/ice storage systems that are designed to provide low temperature [40 – 48°F (4 – 9°C)] central system air distribution to the zone terminals.

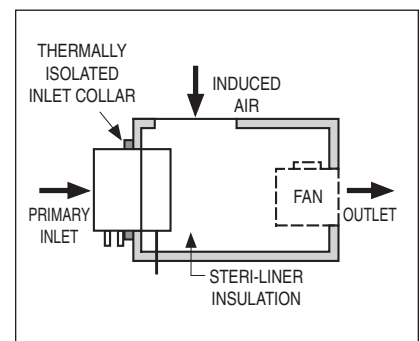

Figure 8. Fan Powered, Low Temperature (Plan View)

Underfloor Fan Powered Series Flow (Constant or Variable Volume)

This low profile terminal is designed to fit between the pedestal support grid of raised, or access floor system HVAC designs, without any modifications to the floor. Available in two unit sizes, only 8" (203) or 11" (279) deep and 20" (508) wide.

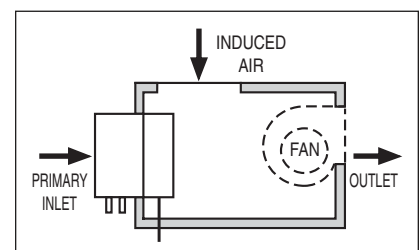

Figure 9. Underfloor Fan Powered, Series (Plan View)

Fan Powered Parallel Flow (Variable Volume/Intermittent Fan)

Description

Basic unit consists of a primary air damper, actuator, flow sensor, blower/motor assembly (with flow adjustment) and selected controls. An accessory heating coil, either hot water or electric, is usually required to satisfy space load conditions.

Operation

The primary air damper throttles the conditioned cold airflow in response to the room thermostat. As the room temperature decreases, the primary damper throttles toward its minimum flow setting and the unit blower, situated in parallel outside the primary airstream, is energized to provide warm ceiling plenum air to the space. A further drop in space temperature energizes the supplementary heating coil. The resultant control provides variable volume air diffusion to the space as well as a variable air volume distribution system to the central equipment.

Common Applications

This terminal is used primarily in exterior zones of buildings where varying occupancy allows the central system to be shut down during unoccupied periods. The unit blower and accessory heater provide heating as required to maintain minimal space temperatures during the shut down periods.

As the fan handles only a reduced heated air volume, the fan can be sized smaller than a series flow terminal. A backdraft damper prevents reverse flow through the fan during the cooling cycle.

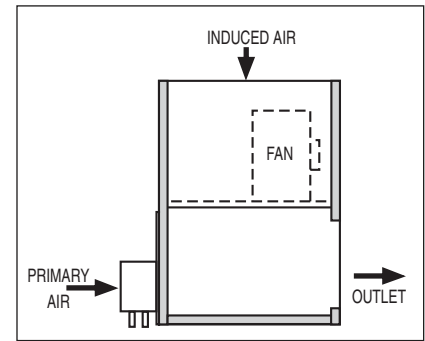

Figure 10. Fan Powered, Parallel (Variable Volume) (Plan View)

Bypass Terminals

Description

Basic unit consists of a diverter type damper, actuator, bypass port and selected pressure dependent controls. A balancing damper is required ahead of the inlet. Accessory reheat coils are a common requirement.

Operation

The terminal delivers conditioned air to the space during periods of maximum cooling requirements (as determined and signaled by the room thermostat). As cooling demands diminish, the unit damper is modulated to bypass increasing amounts of conditioned air to the ceiling plenum. The result is a variable volume air supply to the space while a relatively constant volume of air is maintained across the central system air handling unit.

Occasional Applications

Bypass terminals are used primarily with packaged roof-top air conditioning equipment with a direct expansion coil where zoning is desired, but relatively constant airflows across the system components (i.e. coils, fans) are required. This allows the coil to operate at 100% airflow at all times in order to avoid freeze-up. The system offers an economical VAV supply design with low first cost. It does not provide the energy saving advantages of variable fan volume, but avoids the expense of a more sophisticated system.

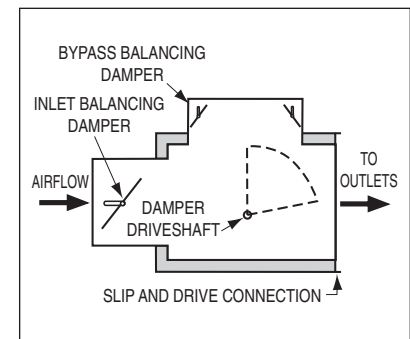

Figure 11. Bypass (Elevation)

Introduction to VAV Terminal Controls

The control of air temperature in a space requires that the variable heating and/or cooling loads in the space are offset by some means. Space loads vary within a building and are influenced by many factors. These may include climate, season, time of day and zone position within the building, i.e. interior or exterior zone and geographic orientation. Other variable loads include people, mechanical equipment, lighting, computers, etc.

In an air conditioning system compensating for the loads is achieved by introducing air into the space at a given temperature and quantity. Since space loads are always fluctuating the compensation to offset the loads must also change in a corresponding manner. Varying the air temperature or varying the air volume or a combination of both in a controlled manner in response to changing load conditions will offset the space load as required.

The variable air volume terminal unit or VAV box allows us to vary the air volume into a room and depending on type selected, also lets us vary the air temperature into a room.

The VAV terminal unit may be pressure dependent or pressure independent. This is a function of the control package.

VAV terminals are the most energy efficient means of providing control as the central system supply may be sized based on the simultaneous peak demand of the total zones. The diversity factor allows a reduction in capacity as the central unit does not have to be sized for the sum of the peak demands of the entire building.

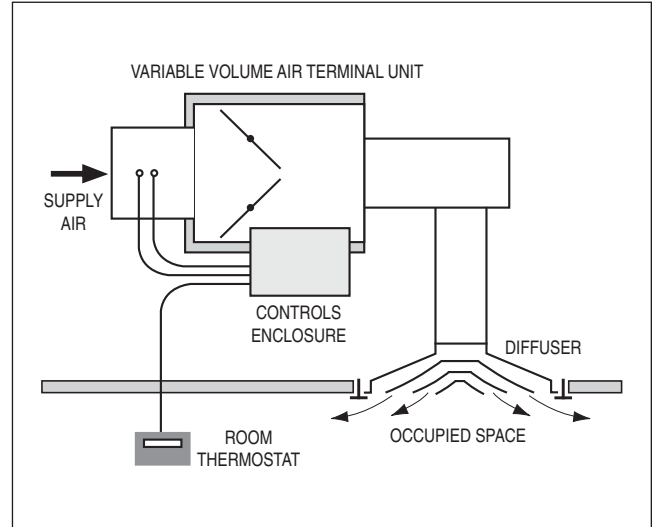

Figure 12. Typical Pressure Independent terminal unit controls and installation.

Pressure Dependent

A device is said to be pressure dependent when the flow rate passing through it varies as the system inlet pressure fluctuates. The flow rate is dependent on both the inlet pressure and the damper position of the terminal unit.

The pressure dependent terminal unit consists of a damper and a damper actuator controlled directly by a room thermostat. The actuator is modulated in response to room temperature only and acts as a damper positioner. (There is no flow sensor or reset controller).

Since the air volume varies with inlet pressure, the room may experience temperature swings until the thermostat repositions the damper. Excessive airflow may also lead to unacceptable noise levels in the space.

The logarithmic graph shown in figure 13a illustrates a pressure dependent terminals' reaction to duct pressure changes for several given damper positions. The line 1a – 1b represents one damper setting or position. As duct pressure increases, so does the airflow over the damper, with the flow rate varying in proportion to the square root of the static pressure drop across the terminal. This characteristic is typical of any fixed orifice or in this case, a throttling damper. Lines 2a – 2b and 3a – 3b represent additional random positions as the damper moves toward the full open position, line 4a – 4b. Pressure dependent terminals are therefore more prone to constant hunting when static pressures fluctuate at the terminal inlet, as the thermostat is responding to variations in flow that it didn't call for. Control accuracy is therefore poorer, when compared to a pressure independent terminal.

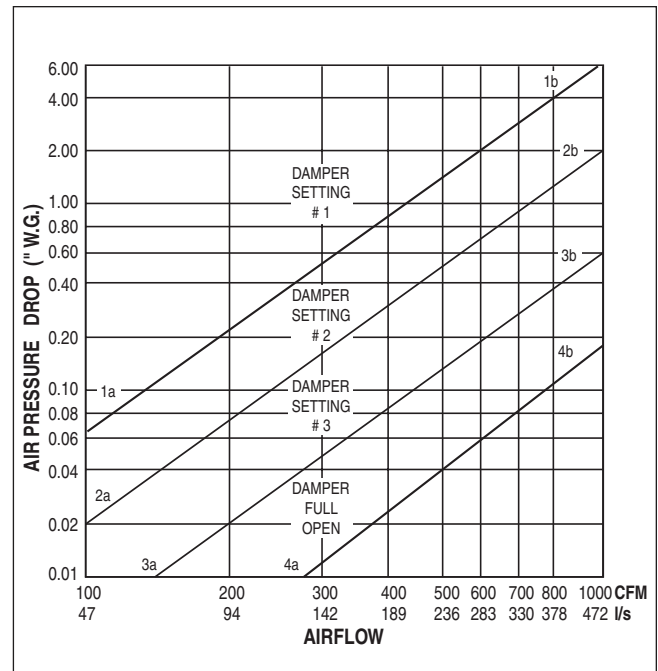

Figure 13a. Pressure Dependent terminal damper characteristics.

The pressure dependent terminal is for applications where neither pressure independence nor airflow limit regulation is required at the terminal. An example is a constant volume central air supply where the downstream static pressure is held constant by other controls. Another example utilizes a constant volume central fan and zone bypass dampers that respond to static pressure variations and short circuit excess air directly back to the air handler.

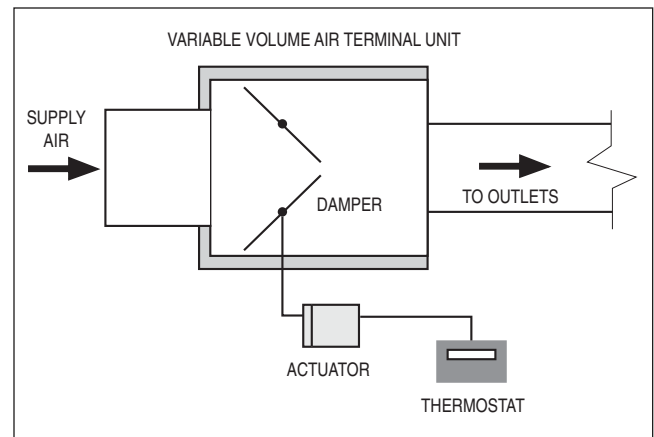

Figure 13b. Pressure Dependent terminal controls.

Pressure Independent

A device is said to be pressure independent when the flow rate passing through it is maintained constant regardless of variations in system inlet pressure.

The pressure independent control is achieved with the addition of a flow sensor and flow controller to the VAV box. The controller maintains a preset volume by measuring the flow through the inlet and modulating the damper in response to the flow signal. The preset volume can be varied between calibrated minimum or the maximum limits by the thermostat output.

The logarithmic graph shown in figure 14a illustrates pressure independent terminals' typical airflow settings and characteristics. The vertical lines 1a – 1b and 3a – 3b represent the calibrated minimum and maximum airflow settings respectively, that are adjusted at the flow controller. Line 2a – 2b represents any intermediate airflow setting maintained by the flow controller in response to thermostat demand. The damper will modulate (open and close) as required to hold the airflow setting constant up and down this vertical line regardless of upstream static pressure variations. Airflow will only change when the thermostat signal (demand) changes. The vertical lines are cut off by the diagonal line 1a – 3a, which represents the minimum operating static pressure requirement of the terminal unit for the given airflow – the pressure drop across the terminal with the damper in the fully open position.

Pressure independence assures the proper distribution of air to the conditioned space as required and allows the engineer to know that the design limits specified will be maintained. Maximum and minimum airflow limits are important for maintaining proper air distribution.

- Maximum airflow limits prevent over-cooling and excess noise in the occupied space.
- Minimum airflow limits assure that proper ventilation is maintained.

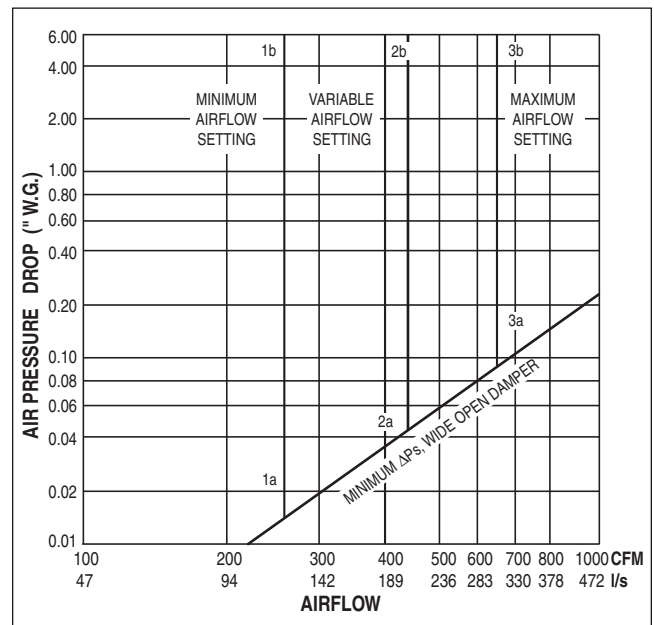

Figure 14a. Pressure Independent terminal damper characteristics.

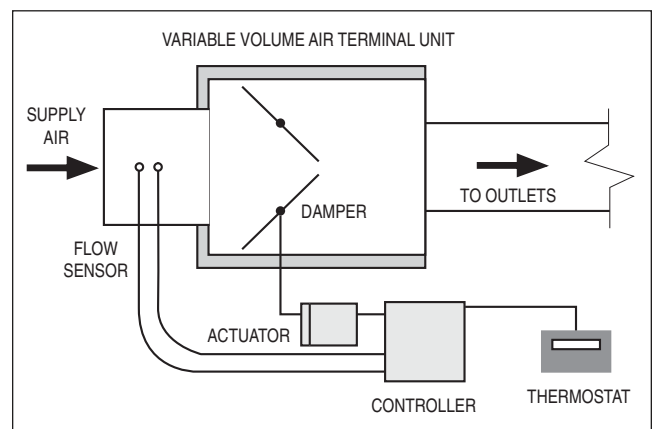

Figure 14b. Pressure Independent terminal controls.

Types of Controls

The various VAV controls available may include some or all of the following common components:

a) Flow Sensor/Pick-up

This device monitors the primary air inlet, measures air velocity and provides a feedback signal to the controller which directs the operation of the damper actuator. This control loop is the essence of the pressure independent operation.

b) Room Thermostat or Temperature Sensor

A room thermostat senses the room temperature, allows set point adjustment and also signals the controller to direct the damper actuator accordingly. Digital controls utilize a temperature sensor. Setpoint changes are managed by the digital controller.

c) Flow Controller

This device is 'the brain' and receives the signals from the Flow Sensor and the Room Thermostat or Temperature Sensor and processes the data to regulate the damper actuator.

d) Damper Actuator

This device receives the commands from the controller and opens or closes the damper to change or maintain the required airflow setting.

Electric Systems (Pressure Dependent)

Electric controls operate at 24 VAC powered by a transformer usually mounted within the control box of the terminal. These systems have no velocity sensor and no controller. There is no compensation for duct pressure fluctuations.

Traditional:

The room thermostat has single-pole-double-throw (SPDT) contacts. A rise in temperature drives a slow cycling damper actuator open in the cooling mode and a fall in temperature reverses the actuator in the heating mode. Thermostat response time to room temperature change is typically less than the actuator response time. Control is sluggish and large temperature swings may result.

State of the Art: Micro-processor based P + I thermostat provides superior control.

Direct Digital Control (DDC) Systems (Pressure Independent)

These micro-processor based electronic controls also operate at 24 VAC powered by a transformer usually mounted within the control box of the terminal.

The flow signal from a pneumatic or electronic velocity sensor and signals from the room temperature sensor are converted to digital impulses in the specialized micro-computer controller. The program usually includes a proportional, integral and derivative (PID) control algorithm for excellent and highly accurate operation.

The controller not only performs the reset and volume control functions, but also can be programmed and adjusted either locally or remotely. It can link to other controllers and interface with fans, lighting and other equipment. Control can be centralized in one computer.

DDC Controls compensate for changes in duct pressure.

Analog Electronic Systems (Pressure Independent)

Analog electronic controls operate at 24 VAC powered by a transformer usually mounted within the control box of the terminal.

The electronic controls feature a velocity sensor (either the hot wire thermistor or pneumatic multi-point type with an electronic transducer) and an electronic velocity controller. They provide a proportional control function.

The electronic thermostat is selected from one of four types; cooling, heating, cooling with reheat or cooling-heating. A three-stage reheat (two stages for fan powered terminals) or automatic heat/cool changeover relay can be furnished in the control box.

Analog electronic controls compensate for changes in duct pressure.

Pneumatic Systems (Pressure Independent)

The pneumatic control system components are powered by compressed air at 20 – 25 psi from a central system.

The room thermostat receives main air at full pressure directly from the air supply. In response to room temperature changes, the air pressure is modulated to the controller, which regulates the damper actuator and provides proportional control. A rise in temperature drives the actuator open in the cooling mode and a fall in temperature reverses the actuator in the heating mode.

The sensor and controller compensate for changes in duct pressure, so that operation is pressure independent.

The controller allows the thermostat to modulate the airflow as the room temperature dictates from a preset minimum to a preset maximum.

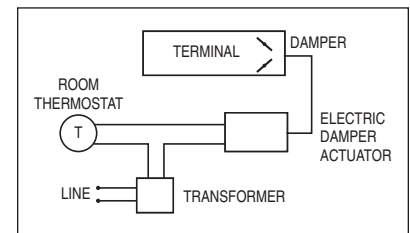

Figure 15. Electric Control Schematic.

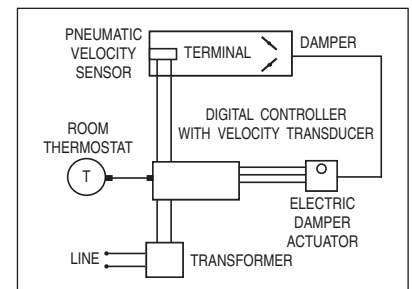

Figure 16. Digital Control Schematic.

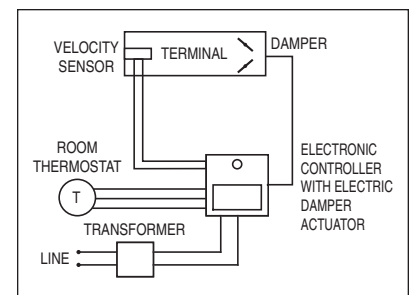

Figure 17. Analog Electronic Control Schematic.

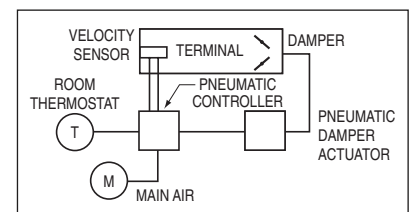

Figure 18. Pneumatic (PI) Control Schematic.

Types of Controls (continued)

Digital Control Overview

A direct digital controller uses a digital computer to implement control algorithms on one or multiple control loops. Interface hardware allows the digital computer to process signals from various input devices. The control software calculates the required state of the output devices, such as valve and damper actuators and fan starters. The output devices are then positioned to the calculated state via interface hardware.

The basic principles of temperature control for heating, ventilation and air conditioning systems are well established. These control strategies have been implemented using pneumatic, electric, and analog electronic control devices. In this computer age, the micro-processor technology is now available in applications specifically designed for HVAC control. Micro-processor based controllers bring cost effective, state of the art computing power to the control of terminal units, air handling units, packaged heating and cooling units, and entire building HVAC systems.

Micro-processor based controllers use direct digital control to replace conventional pneumatic or analog electronic controls. A direct digital controller takes input signals from sensors to generate numbers, processes this information digitally as directed by the programmed sequence of operation, and generates control action through binary on/off outputs or analog output voltages.

Controls Terminology

Thermostat Action (Figure 19).

Directing Acting means that a room temperature increase causes a corresponding increase in thermostat output (pressure or voltage).

Reverse Acting means that a room temperature increase causes a corresponding decrease in the thermostat output.

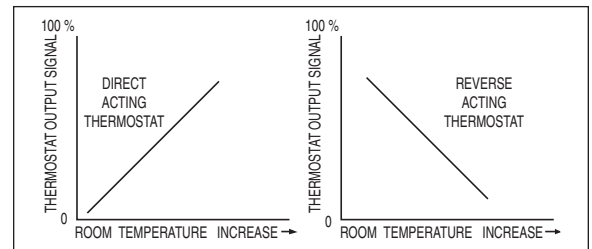

Figure 19. Thermostat Action

Damper Failure State

Normally Open indicates the fail safe position of the damper in a typical pneumatic system. When the control air pressure is removed or fails, the damper is opened by the actuator spring. Control air pressure is required to oppose the spring and close the damper or valve. (Figure 20).

Normally Closed indicates the fail safe position of the damper in a typical pneumatic system. When the control air pressure is removed or fails, the damper is closed by the actuator spring. Control air pressure is required to oppose the spring and open the damper or valve. (Figure 21).

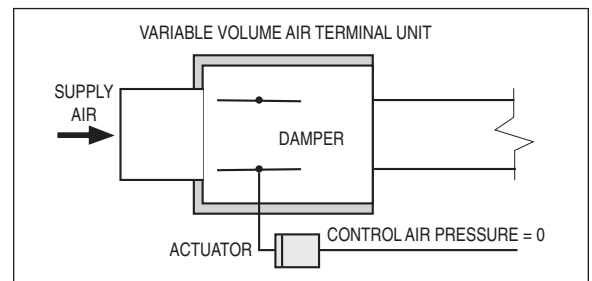

Figure 20. Normally Open Damper

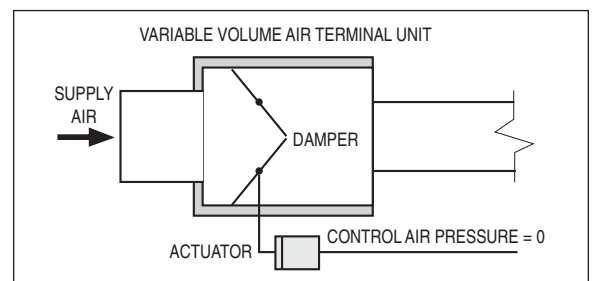

Figure 21. Normally Closed Damper

Electric actuators as used with analog electronic and digital controls are typically of the non-spring return type and therefore the above usually does not apply.

Direct Reset/Reverse Reset Pneumatic Velocity Controller Action (Figure 22).

In the direct reset controller, an increase in the thermostat output pressure causes a corresponding increase in controller airflow setting.

In the reverse reset controller, an increase in the thermostat output pressure causes a corresponding decrease in controller airflow setting.

The damper will open and close to maintain the setting when duct pressures change.

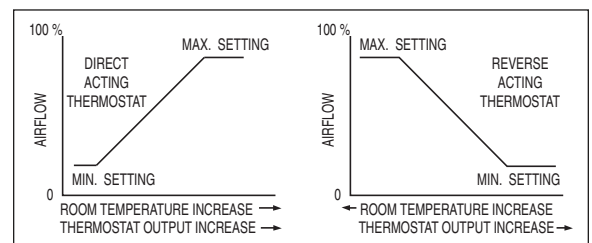

Figure 22. Velocity Controller Action

Pneumatic Thermostat/Controller Combinations (Figure 23).

For systems supplying cold air when a direct acting pneumatic thermostat signals a direct acting controller, an increase in room temperature produces an increase in airflow setting. A reverse acting thermostat with a reverse reset controller produces the same result. A direct acting thermostat with a reverse reset controller or a reverse acting thermostat with a direct reset controller will produce a decrease in airflow as the room temperature increases. With hot supply air, the logic is reversed.

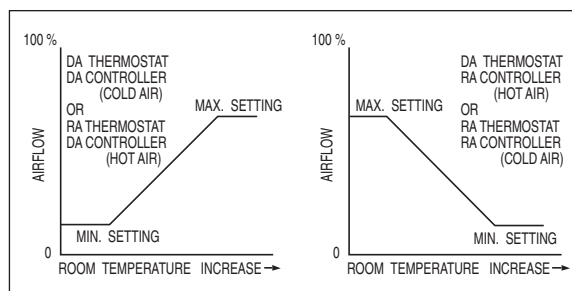

Figure 23. Thermostat/Controller Interaction

Pneumatic Controller/Actuator Combinations

Controllers and actuators work in concert to control space temperatures. With pneumatic controls the most common combinations are DANO (Direct Acting Normally Open) and RANC (Reverse Acting Normally Closed). With most pneumatic controls, dedicated controllers are used for direct and reverse acting and any combinations other than DANO or RANC require extra components and increase air consumption. The Nailor 3000 Universal controller requires no extra components as the unit is switchable.

When electric heaters are used, the most common is RANO. Normally open is the most popular configuration for warm climates because the damper fails to a cooling position. RA fails the heater off.

Typical Operation of a Pneumatic Velocity Controller

The **thermostat set point** is the desired value (room temperature) of the controlled variable. When thermostat output equals this value, the control system is in equilibrium. Most pneumatic thermostats are factory calibrated @ 9 psi (62.1 kPa) thermostat output. This calibration setting may be field adjusted. (Figure 24).

The controller **control point** is the airflow setting that the thermostat is signaling at any given moment and represents the actual equilibrium value of the controlled variable. **Offset** is the difference between the set point and the actual control point at any given moment in time. The damper opening may vary widely to compensate for any duct pressure changes reported by the inlet sensor, and to hold the airflow constant.

The range of values of the controlled variable over which the output of the controller goes from maximum to minimum airflow setting at the controlled device is called the **reset span** or throttling range. This band is adjustable on the controller.

The set point [9 psi (62.1 kPa) in the example] is offset by the action of thermostat anywhere between the **maximum** and **minimum airflow** settings of the controller as room load changes. The corresponding thermostat output pressures are called the **start** and **stop points**. The start point is adjustable on the Nailor 3000 controller.

The thermostat may also control an auxiliary unit, such as a proportioning valve on a hot water coil, modulating over a range of 3 to 8 psi, in sequence with the reset span of the controller. The overall range over which the thermostat controls these devices is its **proportional band** [3 to 13 psi (20.7 to 89.6 kPa) in the example].

Thermostat Sensitivity

The change in output pressure caused by a change in room temperature (Figure 25). Usually this is 1°F (.55°C) = 2.5 psi (17.24 kPa) for pneumatic systems. In this case therefore, the proportional band, 3 to 13 psi (20.7 to 89.6 kPa) represents a temperature range of 4°F (2.2°C).

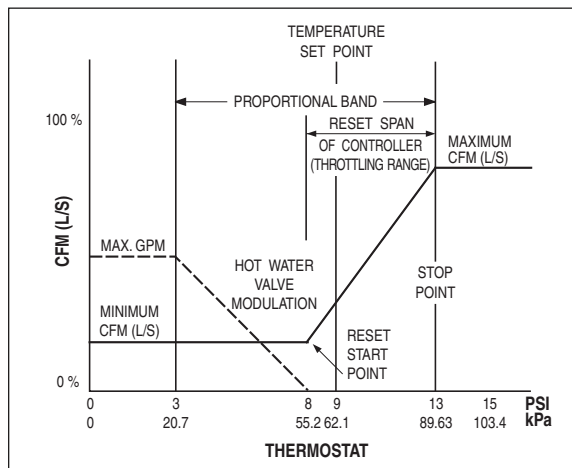

Figure 24.

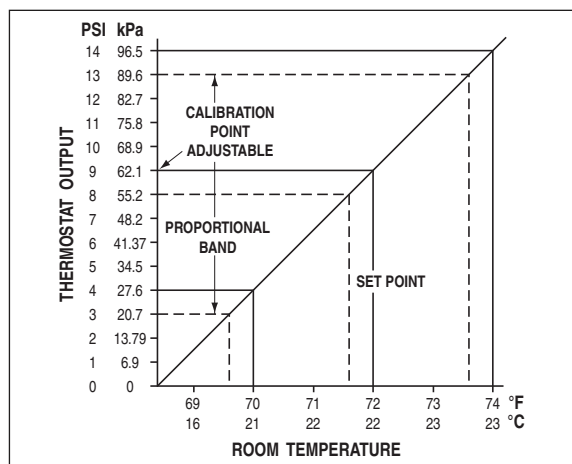

Figure 25.

Features of Series and Parallel Flow Fan Powered Terminal Units

General

Fan powered variable air volume terminal units are the most economical, and consequently the most popular, way to heat and cool many types of buildings today. Typically used for exterior zones, they have advantages for interior zones as well.

Applications

Series

Series units, in the past called Constant Volume Units because the fan runs constantly, are typically installed in the ceiling plenum. Induction air is either from the ceiling plenum or occasionally ducted from the conditioned space. With suitable digital controls, an ECM can be modulated to provide dynamic fan control for extra energy savings at low load.

Parallel

Parallel units, sometimes called Variable Volume Units because the fan is intermittent and the cooling is variable volume, are typically installed in the ceiling plenum. Induction air is either from the ceiling plenum or occasionally ducted from the conditioned space.

Configuration

Series

The fan and VAV damper are aligned so that all the conditioned air that enters the mixing section as well as all the induced air that enters the mixing section must go through the fan to exit the unit and enter the occupied space. The mixing section is between the VAV damper and the fan. See figure 26 below.

Parallel

The fan and VAV damper are aligned so that all the induced air enters the fan, but the conditioned air bypasses the fan and mixes with the induced plenum air on the discharge side of the fan. See figure 27 below.

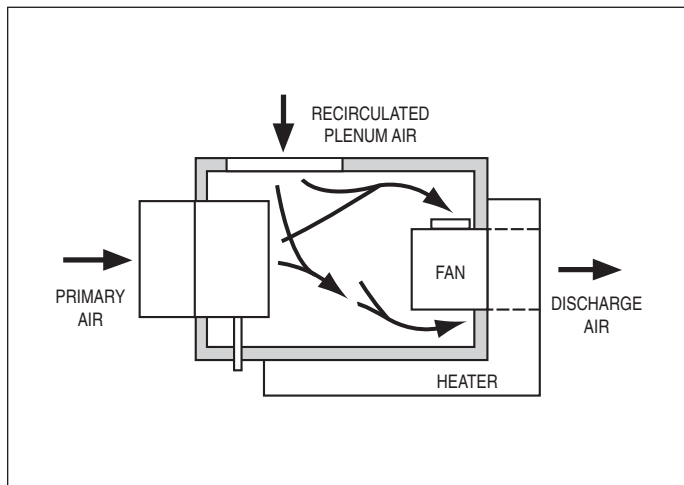

Figure 26. Series Flow Terminal Configuration

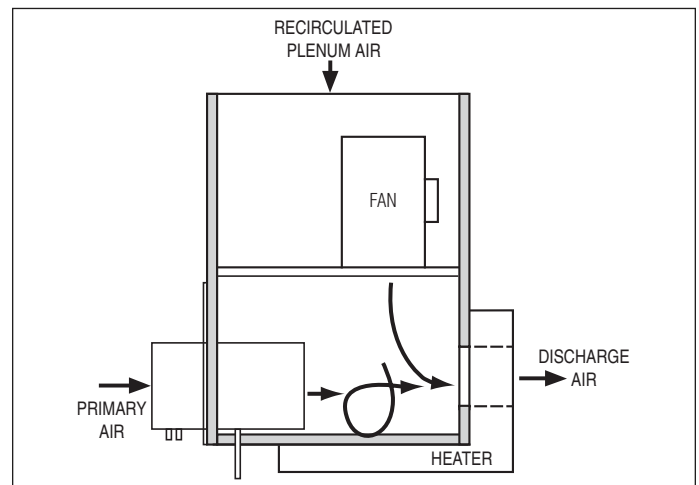

Figure 27. Parallel Flow Terminal Configuration

Fan Design

Series

Typically the fan runs continuously supplying a constant volume to the space. Most DDC controls manufacturers provide an optional analog output on their controller which may be used for controlling fan airflow via the Building Management System. This allows dynamic fan speed control which may be either modulating or multiple speed operation from a single speed motor. Usually this would require Nailor EPIC™/ECM fan volume control technology. The fan must be sized to match the maximum airflow to be supplied to the zone. These units usually have larger fans than similar zones with parallel units. Fan energy consumption is constant during occupied periods with constant volume operation or variable dynamic fan control is utilized.

Parallel

Typically the fan runs intermittently supplying a constant volume to the space while it runs during deadband operation and on a call for heating. The fan must be sized to match the heating airflow to be supplied to the zone. These units usually have smaller fans than similar zones with series units. Fan energy consumption is intermittent during occupied periods when heating is required.

VAV Cooling and Inlet Static Pressure Requirements

Series

All the savings of VAV operation at the air handler and at the chiller are retained by using the series unit. Additional savings compared to single or dual duct VAV are realized due to the low inlet static pressure requirement of the Nailor 35S. Since the air handler is only required to push the conditioned air through the ducts to the unit and across the VAV damper into the mixing section, the pressure at the air handler can be greatly reduced. Nailor 35S units require only 0.05" w.g. (12 Pa) static pressure at the inlet to operate properly. This is much less than the competition. Using the 35S allows the duct designer to reduce the minimum static pressure in the upstream ductwork to (typically) 0.1 to 0.2" w.g. (25 – 50 Pa) or whatever is required to allow 0.05" w.g. (12 Pa) at the terminal while allowing a further reduction in horsepower and static pressure requirement from the air handler.

Parallel

All the savings of VAV operation at the air handler and at the chiller are incorporated in the parallel unit. Like the single or dual duct VAV, the air handler must push the conditioned air through the ducts to the unit, across the VAV damper, into the mixing section, through the discharge duct from the unit and across the diffuser(s) into the room. Compared to other manufacturers, Nailor 35N units require very low static pressure at the inlet to operate properly. This means that the duct system should be designed for minimum static pressure, typically 0.5 to 1.25" w.g. (125 – 310 Pa). Then the air handler should be adjusted as low as possible to keep the minimum requirement at the farthest VAV terminal unit.

Series

The fan runs constantly during occupied periods. During full cooling, the controls open the VAV damper to its maximum set point, delivering primary air to the mixing chamber. If the fan is set at the same airflow as the primary air VAV damper, then no air is induced from the plenum. If the fan is set at a higher airflow than the VAV damper, as it would be in a low temperature application, then air is induced from the plenum to meet the set point of the fan. The primary air and the induced air are blended before they enter the fan. Constant volume, constant temperature air is then discharged into the downstream duct and into the conditioned space.

As cooling demand decreases, the VAV damper modulates to lower set points until it reaches its minimum set point. Reducing the primary air into the plenum increases the volume of warmer induced air into the mixing chamber. The unit delivers blended, constant volume, variable temperature air to the zone. The increased plenum air causes the discharge temperature to rise to nearly meet the plenum temperature taking advantage of the recaptured heat from lights, people and machinery.

Upon a further decrease in zone temperature, the controls will automatically energize the supplemental heat (optional equipment), either electric or hot water coils. The discharge temperature will increase as heat is applied.

As the temperature increases in the zone, the sequence will reverse.

Control Sequence

Parallel

During full cooling, the controls open the VAV damper to its maximum set point while the fan does not run. Constant volume, constant temperature air is then discharged into the downstream ducts and into the conditioned space.

As cooling demand decreases, the VAV damper modulates to lower setpoints. The unit delivers variable volume, constant temperature air to the zone.

Upon a further decrease in zone demand, the controls will automatically energize the fan. Fan air and primary air are blended in the mixing chamber on the discharge side of the fan. The increased plenum air causes the discharge temperature to rise to nearly meet the plenum temperature as the zone temperature continues to fall. This takes advantage of the recaptured heat from lights, people and machinery. Blended, variable volume, variable temperature air is delivered to the zone.

At this same point, the VAV damper will reach its minimum set point. At some preset zone demand, supplemental heat (optional equipment), either electric or hot water coils will be energized. The discharge temperature will increase as heat is applied but volume will be constant beyond this point.

As the temperature increases in the zone, the sequence will reverse.

Series

Fan Interlocks

Sometimes series units are designed to run continuously. Usually, they are energized only during occupied periods or when needed for emergency heating during unoccupied periods. It is important to interlock the unit fan with the air handlers in the building to insure that they start during occupied periods. Series unit fans should be started ahead of the air handler to prevent back flow into the plenum and backwards rotation of the fan. Nailor 35S series units have a built-in, anti-backward rotation device; however, if the fan is allowed to rotate backwards at unusually high rpms before the motor is energized, the device can be overwhelmed by the backward momentum causing the motor to run backwards. Interlocking the unit fan with the air handler eliminates this problem. Interlocks can be airflow switches or relays to match the building management system. A proper starting sequence in the BAS will also eliminate the potential problem of background rotation.

Parallel

The fans in Nailor 35N units are designed to be energized as needed throughout the day. The primary air enters the mixing chamber at the fan discharge. When the fan is not energized, there is a positive pressure at the discharge of the fan. Typically, this would cause the blower and motor to rotate backwards. However, all Nailor 35N units are equipped with a backdraft damper at the fan discharge inside the unit. This damper prevents backward airflow through the fan and into the plenum. Nailor backdraft dampers are gasketed for low leakage and quiet operation.

Acoustics

Series

Series fans are sized to match the maximum airflow required in the zone. The fan runs constantly during occupied periods. There are two sound sources in the unit, the fan and the VAV damper. While both contribute to the overall discharge and radiated sound emitted from the unit, the fan is primarily responsible for discharge sound while both the damper and the fan are responsible for radiated sound. Usually the radiated sound into the room is the larger and therefore more critical of the two components.

Comparing the sound level between a series and a parallel unit in similar zones, the series unit might generate slightly more sound. The fan and damper would be at their peak when the unit operates at full cooling capacity, the worst position in the sequence of operation for noise generation. As the primary air and fan decrease, the sound generated would decrease as well.

Damper noise must be considered, however, as the sound decreases with decreasing inlet static pressure. It would be possible to select a very quiet series unit if very low inlet static pressure were utilized along with a very quiet fan since both components would decrease the radiated sound significantly.

Fan sound is constantly emitted into the zone. If the building is designed well and the terminal units are selected correctly, the fan will be the major noise component.

Parallel

Parallel fans are sized to match the heating cfm required in the zone. The fan runs intermittently when heating is required. There are two sound sources in the unit, the fan and the VAV damper. Both the damper and the fan are responsible for radiated and discharge noise. Usually the radiated sound into the room is the larger and therefore more critical of the two components.

Comparing the sound level between a parallel and a series unit in similar zones, the parallel unit might generate slightly less noise. The fan and damper would never peak simultaneously. When the unit operates at full cooling capacity, the damper would be at its peak sound generation. During heating requirements, the fan would peak while the damper was at minimum sound generation.

Damper sound must be considered, however, as the sound increases with increasing inlet static pressure. Parallel units require much higher inlet static pressures at the unit.

Fan sound is constant into the zone when the fan is running; however, it is intermittent during much of the day. This fan cycling can be very annoying in the occupied space. Even if the overall sound level is lower than that of a similar series unit, the variation in sound levels in the space during the day can be much more noticeable than a higher constant sound level.

Energy Consumption

Fan powered VAV terminal units were originally designed and introduced to our industry for their ability to save energy. That is what makes them so necessary and popular. They take advantage of typical VAV savings at the air handler and the chiller during the cooling periods, but the real savings kick in when heating is required. Fan powered terminals induce warm plenum air from the ceiling and blend it with the primary air. The primary air damper minimum setting meets the minimum ventilation requirements during the heating sequence. This recaptures all the heat created in the zone and plenum by lights, occupants, solar loading, and machinery or equipment such as computers, coffee machines, copiers, etc. Then the unit returns this heat as free heating rather than wasting it back at the air handler, providing a comfortable blended airflow and eliminating reheat in the heating mode. If additional heating is required, then supplemental heat is added to the sequence, but the unit still saves energy by warming blended air at 75°F (24°C) rather than reheating primary cooled air at 55°F (13°C), saving the cost of 20°F (11°C) at the heating airflow. Costs of operating the units pale in comparison to the savings over other systems.

Series

Series fans run constantly during occupied periods, and the fan is sized for the full airflow to the zone. This causes the energy consumption from the fan to be higher than that of a parallel fan in a similar zone.

On the other hand, series units are designed for very low inlet static pressures. This saves energy at the air handler compared to a parallel unit for a similar zone. Varying the fans airflow in cooling mode reduces the amount of plenum air in cooling mode, but can provide further energy savings.

Parallel

Parallel fans run only when required during the heating sequence and deadband. The fan is sized for the heating airflow, which may be much less than the total airflow requirement for the zone.

As the mixing of minimum primary air and induced air takes place downstream of the terminal fan, the terminal inlet static pressure requirement is greater than a series terminal. This usually adds cost at the air handler. Additionally, since the fan air and primary air mix in a positively pressurized plenum, parallel units have been shown to leak primary air into the return air plenum, due to casing and backdraft damper leakage (ASHRAE Research Project 1292). Some studies have shown this added cost to be in excess of the added operating cost of running the motors constantly in the series terminal configuration.

Fan Selection

Nailor ECM/EPIC Fan Technology[®]

The recent introduction and availability of Electronically Commutated Motors (ECM) as an option for series fan powered terminal units is rapidly replacing the PSC induction motor. These motors provide significant energy savings and superior controllability. See ECM/EPIC Fan Technology[®] in Fan Powered Terminal Units section of this catalog for a full explanation.

Many times specifications call for fan selections to be made using medium speed on the blower motor. This can cause some concern with Nailor fan powered terminal units because we use only single speed motors, and consequently there is no medium speed for selecting the equipment sizes. There is a solution.

Examine a Nailor fan curve like the one shown below (figure 28). Then examine the comparative fan curve (also illustrated) for a competitor's unit using a 3 speed motor.

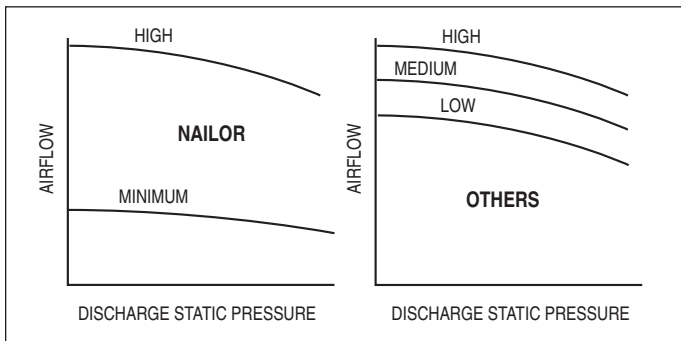

Figure 28. Nailor Fan Curve vs. 3 Speed Fan Curve.

It is important to note that the Nailor unit has a much larger turn down ratio than the unit with the 3 speed motor. Medium speed is not halfway between the high and low curves on the Nailor unit, but rather nearly 80% above the minimum speed curve and paralleling the high speed curve. This is typical of units which employ 3 speed motors.

When selecting a unit for a particular set of conditions, care should be taken to select the unit such that the air delivery is designed to meet the room sound and static requirements. Specific sound data can be found on the sound data sheets for various airflow deliveries for each unit. This should be the guiding factor in selecting unit sizes.

A simple rule of thumb is that when considering a unit selection for a typical office space, the fan should be selected for performance down from the high end performance by 20% to 25% of the distance to the low end curve at the specified external static requirement. This allows for very low room sound levels while maintaining some flexibility for future changes in the zone. If you are selecting equipment for large open areas where sound is not critical, select closer to the maximum cfm curve. If you are selecting equipment for a meeting room or an executive office, maybe you should select equipment slightly below center. If you are selecting equipment for an auditorium or some similarly sensitive area, select operation very near the minimum curve.

Avoid selecting equipment right on the maximum or minimum curves. This leaves no flexibility in the equipment for future changes.

Fan Airflow Control on Fan Powered Terminals

Introduction

When designing air systems and using fan powered VAV terminal units, it is as important to match the fan air to the space requirements as it is to match the primary air. This is even more true on series units than on parallel units. To facilitate this process, Nailor Industries designed their units to work over a wide range of adjustability. Some competitive products are not as friendly to adjust. The two commonly used methods are electronic fan speed control and mechanical trimming.

Fan Shift in Series Fan Powered Terminal Units

Before adjusting the fan, the possibility of fan shift must be considered. Some VAV terminal units suffer from a condition known as fan shift. This occurs when the blower is subjected to variations in pressure on the inlet side of the fan. As the primary damper changes from full cooling to minimum cooling, the pressure drop caused by the induction mixing chamber and associated inlet attenuators may cause the fan to shift its performance as it rides the fan curve. Consequences from the phenomenon vary from building to building and zone to zone, but if diffusers add background masking noise at design flow, then the noise levels will change as the volume changes and this can be very annoying. Design ventilation rates can also vary. These are serious problems and that is why Nailor series fan powered terminal units are designed to eliminate fan shift.

Mechanical Trimming (PSC Motors)

Mechanical trimming involves the use of a damper, usually manually adjustable, and usually employs a 3 speed motor. The damper can be located either in the induction port opening or on the discharge of the fan. Usually, it is on the fan. Mechanical trimming is used to balance the fan airflow. After "ball parking" the fan by selecting the fan speed, high, medium or low, then the damper is adjusted to fine tune the desired airflow. While this is a lower first cost option than the voltage adjustment speed controller, it causes higher operating costs and higher noise levels. When adjusted, the damper will regulate the airflow by raising the static pressure at the fan. The fan must then overcome the higher static levels. This increases rpm, thereby increasing tip speed, air velocity and vibration. Noise goes up. The fan will ride the fan curve similar to the one shown in figure 29. Airflow drops and power consumption drops, too. However, the power consumption does not drop as fast as the cfm drops. Overall efficiency diminishes as the damper throttles the fan.

Electronic Fan Speed Control (PSC Motors)

Nailor fan powered terminals equipped with PSC motors (standard) feature SCR solid state speed controllers.

Electronic fan speed controls utilize a triac to adjust the fans electrical AC voltage. This is called phase proportioning or wave chopping. When the sine wave crosses the zero point as shown in figure 30, the triac acts as a timing device holding the voltage off the motor for some preset period of time. When the triac is turned on, the voltage will seek out the sine wave, then follow the curve to the next zero crossing where the process will begin again on the opposite side of the sine wave. Basically, this reduces the RMS value of the voltage supplied to the motor. This in turn reduces the torque available to turn the rotor and lowers the rpm. Amp draw is very slightly affected during this process if the motors and blowers are sized properly as they are on Nailor units. Some manufacturers suffer from large changes in amp draw that significantly affect the efficiency and operating characteristics of the motor. This should be avoided. Reducing the voltage while holding the amperage draw nearly constant, reduces the power consumption of the motor. Nailor units maintain a nearly constant watt consumption per cfm delivered over the entire operating range of the motor. The graph depicted in figure 31 illustrates typical data on watts, amps, rpm and cfm as RMS to the motor is decreased.

Nameplate Ratings

Nameplate ratings on the motor may or may not match the nameplate ratings on the fan powered terminal unit. They usually do not match. Amp draw can be above or below the motor nameplate. Even voltage can vary. When the motor manufacturer generates his rating data, there is a specific standard used by motor manufacturers for that purpose. It is not what the motor is subjected to when it is applied in the fan powered terminal unit. There is another standard for rating the unit, specifically UL 1995. This is the standard for rating fan powered terminal units. Although they might be significant in some cases, differences in these ratings do not affect the performance or lifetime of the motor or unit. Be careful to refer to the nameplate ratings on the unit when sizing fuses or other overcurrent protection and starters. Nailor ratings are set at the worst possible condition. As static and setpoints vary on each unit, performance may not be what is on the unit nameplate, but amp draws should never exceed the unit nameplate.

Caution on Meters

Many digital multi-meters are not designed for true RMS readings. Using these meters when measuring amps or voltage on the motor in the fan powered terminal unit can result in erroneous readings. To measure the correct current and voltage, a true RMS DMM designed for this type of sine wave is required. These meters can be relatively expensive.

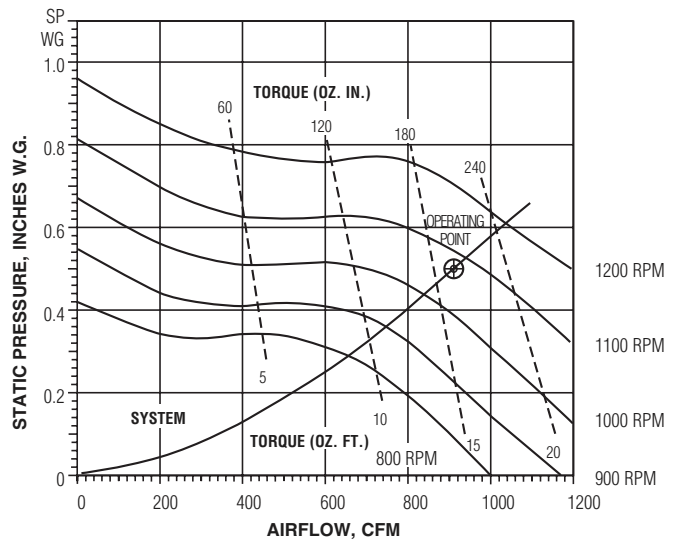

Figure 29. Fan Performance Curve

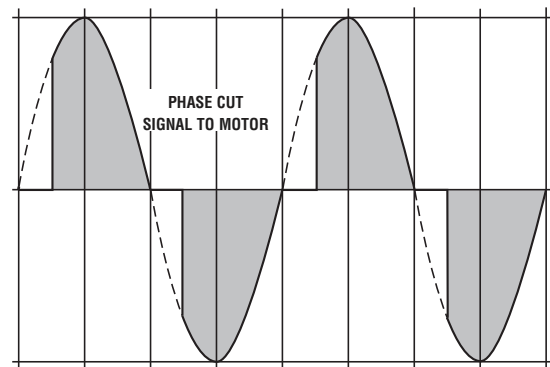

Figure 30. Typical Voltage Sine Wave to Motor from Speed Controller.

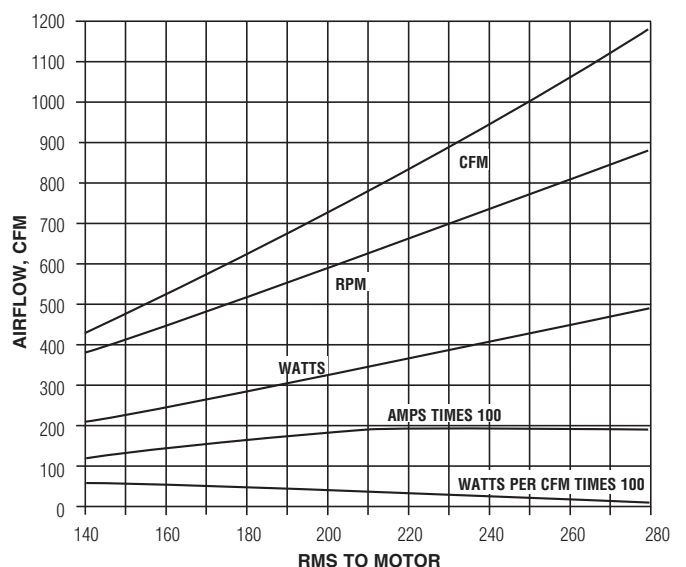

Figure 31. Typical Motor Data

Sizing Fan Powered Terminals

The selection of fan powered terminal units involves four elements. How these elements are selected and their interactive effect determine the final overall performance of the units.

1. Primary Air Valve Selection

Identify the type of controller that is desired and select an inlet size that meets the minimum and maximum airflow desired from the recommended primary air cfm range table provided in the Performance Data section of the catalog. Selecting terminals near the top of their range may reduce cost, but will increase velocity and noise. For typical low pressure applications – selecting towards the bottom of the airflow range will reduce sound levels as larger inlets reduce face velocity and are quieter. Selecting the maximum airflow setting at between 70 – 85% of full capacity (approx. 2000 fpm inlet velocity) is a good trade-off to avoid possible low velocity control problems and sound problems at higher velocities.

2. Fan Size Selection

Fan selection is dictated by model, type and maximum primary airflow.

Parallel (intermittent) fan size is determined by calculating the difference between the unit design heating airflow and minimum primary airflow. If minimum airflow is zero, then fan cfm is the heating airflow. In most cases the fan can be downsized compared to a series terminal, reducing both first cost and operating cost because the fan only requires the capacity to handle the secondary airflow at reduced downstream static pressure compared to the maximum design airflow. In many applications of a parallel terminal, a minimum primary cfm is required to meet ventilation requirements. This primary airflow contributes to the total resistance experienced by the fan and should be accounted for in all components downstream of the fan (ductwork and diffusers). Hot water coils when positioned out of the primary airflow and are not affected by the additional primary airflow. The static pressure resistance felt by the fan due to a hot water coil is then based upon fan airflow only, not necessarily total heating airflow.

Series (constant) fan terminals require the fan to be sized to handle the maximum design cfm. The secondary fan cfm must be at least equal to the primary air to ensure the terminal does not become pressurized resulting in primary air spilling out into the ceiling plenum through the induction ports. The external static pressure requirements are the sum of the ductwork and diffusers downstream at design airflow plus an applicable hot water coil or electric heater, if required.

When fan airflow and downstream static pressure have been determined, select the fan size from the fan curves in the Performance Data section of the catalog. Selecting towards the upper end of the range will keep down first cost and optimize fan operating efficiency. Upsizing the fan and operating it at a reduced speed can result in quieter operation. When electric or hot water coils are required, the fan curves show unit performance with the coils in place. Be sure to use the proper fan curve.

3. Heating Coil Selection

First determine the heating supply air temperature to the space by calculation using the heat transfer equation:

$$Q = 1.085 \times \text{cfm} \times \Delta t$$

Where: Q = Design heat loss (Btu)

Δt = Supply air temperature (SAT) – Room design temperature.

The supply air temperature (SAT) to the space equals the leaving air temperature (LAT) for the terminal unit.

Once the terminal LAT is determined, the heating requirements for the coil can be calculated. The leaving air temperature for the coil varies based on the type of model.

It is generally a good idea to maintain air temperatures of 85 – 90°F (29 – 32°C) for air entering a room. This is LAT off the heating coil. Air this temperature can be effectively used to warm the room as it is not so buoyant that it cannot be driven to the floor, and it is warm enough to not produce chills from drafts.

Once both coil EAT (entering air temperature) and LAT are calculated, the heat transfer (Q) for the coil must be calculated, using the heat transfer equation. For electric heat, the capacity must be converted from Btu/h to kWh for selection. The required kW and number of steps desired should be checked with availability from the charts in the Performance Data section of the catalog. For hot water coils, reference the capacity charts in the Performance Data to select the appropriate coil.

In figures 32, 33 and 34, heating coils are located on the unit discharge so LAT for the coil equals the LAT for the terminal unit. Heating coil EAT equals the temperature of blended primary air and plenum air.

$$\therefore \text{EAT (of coil)} = \frac{T_1 Q_1 + T_2 Q_2}{Q_T}$$

Where:

T₁ = Plenum air temperature

T₂ = Primary air temperature

Q₁ = Plenum air quantity (cfm)

Q₂ = Primary air quantity (cfm)

Q_T = Total air moved by terminal fan (cfm)

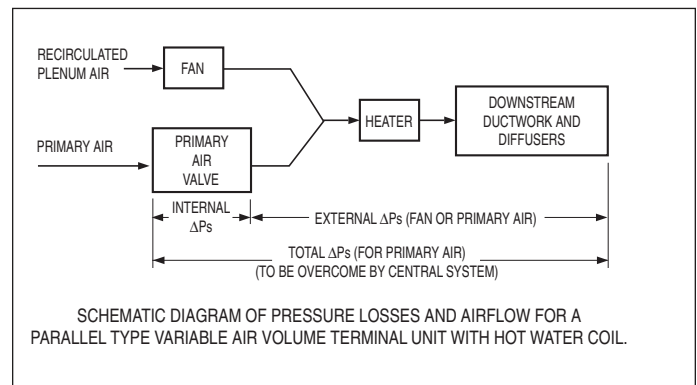

Figure 32. Parallel Terminal with Hot Water Coil: Heating coils are located on the leaving air side of the fan after mixing with the primary air. In this case, coil EAT must be calculated using a mixing equation if minimum primary air is other than zero as it will be blended with plenum air.

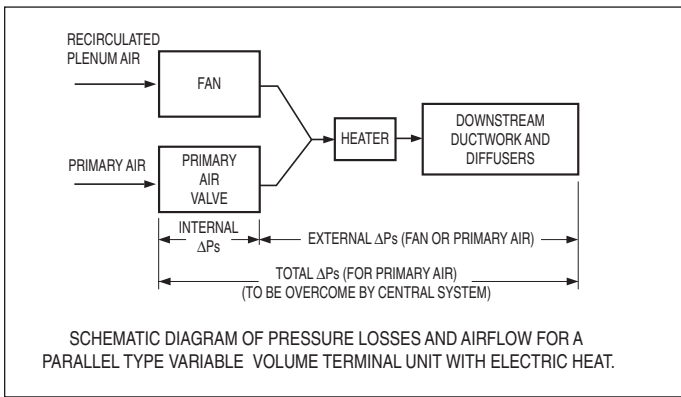

Figure 33. Parallel Terminal with Electric Heat.

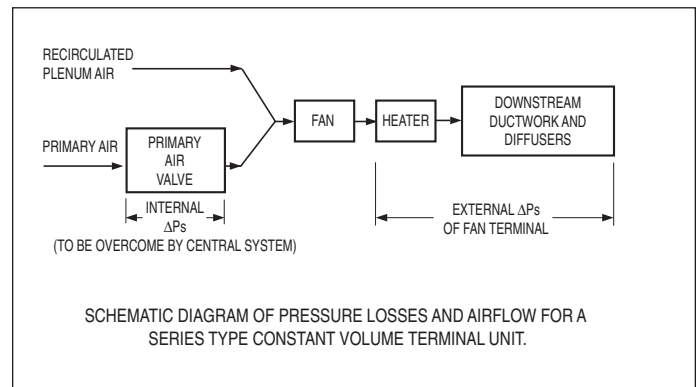

Figure 34. Series Terminals with Hot Water or Electric Heat.

4. Acoustics

Resulting sound levels are due to air valve generated noise and fan generated noise. The maximum noise generated by a given air valve size is determined by the difference between design inlet static pressure (the valve's most pressurized condition) and external static pressure at design cooling airflow. This represents the most extreme operating condition.

To determine fan noise levels, fan airflow (adjusted within its range by the speed controller) and external static pressure conditions are required.

The acoustical performance data is presented in two formats for the parallel and series type as their sequence of operation differs. With a parallel unit, air valve and fan operation are evaluated separately as their operations are not simultaneous under most conditions. With a series unit, air valve and fan are evaluated together for cooling, as they operate simultaneously and fan only for heating, in the occupied mode (in the unoccupied mode, a night setback fan cycling option is available).

From the performance data, determine the sound power levels and NC predictions for both discharge and radiated path under the appropriate operating conditions. If the terminal is properly located some distance from the supply air space, discharge air noise is generally a secondary concern. Radiated noise from the unit casing typically dictates the noise level when the terminal is installed above the occupied space.

Care should be taken as published NC levels are based upon certain path attenuation assumptions which may not be indicative of a specific design. The size of the appropriate portions of the terminal may be increased to reduce noise, but it is also preferable to plot NC reductions on an NC curve chart to ensure the necessary attenuation reductions are achieved and finished levels do not exceed the NC design goal in the occupied space. To do this properly, the engineer must specify all reductions in the building specifications that will apply.

Example: Parallel Terminal with Hot Water Heat

Select a **Model 35NW** for a maximum/minimum primary airflow at 1000/250 cfm with 1" w.g. inlet static pressure. The heating airflow required is 600 cfm. Downstream resistance at 1000 cfm is 0.4" w.g.. Zone design heat loss is 12,000 Btu, design room temperature 72°F, plenum air temperature 75°F, primary air temperature 55°F.

Air Valve Selection: Choose a size 10 inlet with a minimum wide open static pressure drop of 0.05" w.g..

Fan Selection:

Fan heating airflow = Heating airflow (600 cfm) – primary airflow (250 cfm) = 350 cfm.

The downstream static pressure the fan must overcome is the fan airflow plus primary airflow (600 cfm) and since this is less than maximum design airflow (1000 cfm); fan downstream S.P. = $(600/1000)^2 \times 0.4 = 0.144$ " w.g..

From the fan curves a size 2 unit will handle 350 cfm at 0.144" S.P. with correct setting of the speed controller and allows for the selection of a one or two row hot water coil.

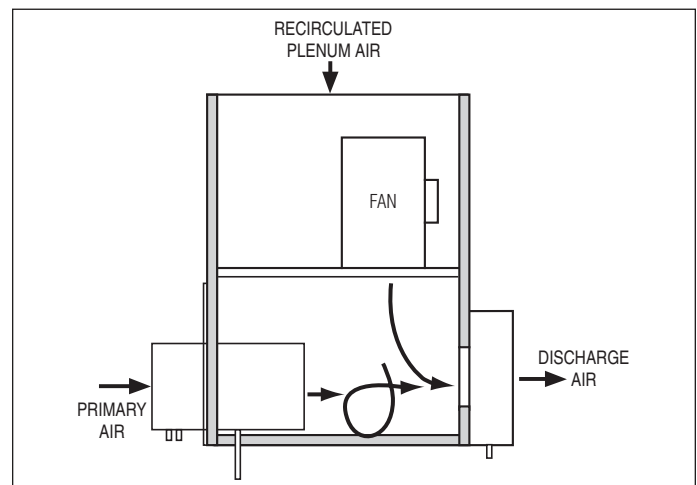

Figure 35. Parallel Fan Terminal With Hot Water Heat in Heating Mode. Model 35NW.

Heating Coil Selection:

For heating, the temperature difference (Δt) is the zone supply air temperature (SAT) minus the design set point temperature.

$$12,000 \text{ Btu} = 1.085 \times 600 \times (\text{SAT} - 72)$$

(using the heat transfer equation)

$$\therefore \text{SAT} = 90^\circ\text{F}$$

As the heating coil is on the unit discharge, the unit supply temperature equals the coil LAT. Coil entering air temperature (EAT) is a mixture of plenum and minimum primary air.

$$\text{Design Heating Flow} \times \text{Coil EAT} = (\text{Primary Airflow} \times \text{Primary Air Temp.}) + [(\text{Design Heating Airflow} - \text{Primary Airflow}) \times \text{Plenum Temperature}]$$

$$600 \times \text{Coil EAT} = 250 \times 55 + (600 - 250) \times 75$$

$$\therefore \text{Coil EAT} = 67^\circ\text{F}$$

For the heating coil, the temperature difference is the coil LAT minus the coil EAT.

$$\text{Coil heat pick up (Q)} = 1.085 \times \text{Design cfm} \times (\text{Coil LAT} - \text{Coil EAT})$$

$$\text{Coil Q} = 1.085 \times 600 \times (90 - 67) = 14,973 \text{ Btu} = 15.0 \text{ MBH}$$

From the hot water coil data, unit size 2, selection of a 1 row coil at 600 cfm will provide 15.0 MBH at about 0.8 GPM (based upon a Δt of 110°F between entering air and entering water).

Note: While there is air side pressure drop data in the catalog, it is not necessary to calculate it. The coil pressure drop is included in the fan curves marked as maximum with water coil.

Acoustics: The selection is a 35NW-2-10 with a 1 row hot water coil. At 1" w.g. design inlet static pressure, the closest tabulated sound data @ 1100 cfm cooling and 600 cfm (400 cfm from fan) heating is:

Octave Band		2	3	4	5	6	7
Design maz. Cooling (1100cfm)	Disch.	68	66	62	53	54	55
	Rad.	61	56	52	40	40	40
Design Heating (400 cfm)	Disch.	62	55	54	50	47	46
	Rad.	67	60	58	52	45	43

Example: Series Terminal with Electric Heat

Select a **Model 35SE** to supply a constant 1500 cfm with 0.5" w.g. inlet static pressure. Minimum primary airflow is 375 cfm and downstream resistance due to ductwork and diffusers is 0.4" w.g.. Zone design heat loss is 45,000 Btu, design room temperature 72°F, plenum air temperature is 75°F, primary air temperature 55°F.

Air Valve Section: Choose a size 12 inlet with a minimum wide open pressure drop of 0.05" w.g.. The damper will throttle to maintain desired airflow.

Fan Selection:

Fan airflow equals design airflow with a series unit. Fan external static pressure equals downstream static pressure (ductwork and diffusers). The resistance of electric and hot water heating coils and their associated additional pressure drop is taken into account on the fan curves. From the fan curves, a size 5 unit will handle 1500 cfm at 0.4" and falls nicely in the middle of the fan range which can be adjusted with the speed controller.

Heating Coil Selection:

For heating, the temperature difference (Δt) is the zone supply air temperature (SAT) minus the design set point temperature.

$$30,000 \text{ Btu} = 1.085 \times 1500 \times (\text{SAT} - 72)$$

$$\therefore \text{SAT} = 90^\circ\text{F}$$

As the heating coil is on the unit discharge, the unit supply temperature equals the coil LAT. Coil entering air temperature (EAT) is a mixture of plenum and minimum primary air.

$$\text{Design Heating Flow} \times \text{Coil EAT} = (\text{Primary Airflow} \times \text{Primary Air Temp.}) + [(\text{Design Heating Airflow} - \text{Primary Airflow}) \times \text{Plenum Temperature}]$$

$$1500 \times \text{Coil EAT} = 375 \times 55 + (1500 - 375) \times 75$$

$$\therefore \text{Coil EAT} = 70^\circ\text{F}$$

For the heating coil, the temperature difference is the coil LAT minus the coil EAT.

$$\text{Coil heat pick up (Q)} = 1.085 \times \text{Design cfm} \times (\text{Coil LAT} - \text{Coil EAT})$$

$$\text{Coil Q} = 1.085 \times 1500 \times (90 - 70) = 32,550 \text{ Btu} = 32.6 \text{ MBH}$$

$$\text{Convert to kWh: } 32.6 \div 3.413 = 9.6 \text{ kWh}$$

From the electric heat selection data in the Performance Data section of the catalog, a size 5 unit requires a 208, 240 or 480 volt/3-phase electric heat coil and would be available with up to 3 stages with pneumatic or digital control or 2 stages with analog electronic control.

Acoustics: The selection is a Model 35SE-5-12. At 0.5" w.g. design inlet static pressure, the closest tabulated sound data is @ 1500 cfm is:

Octave Band	2	3	4	5	6	7
Discharge	78	74	70	69	66	65
Radiated	73	66	66	56	54	53

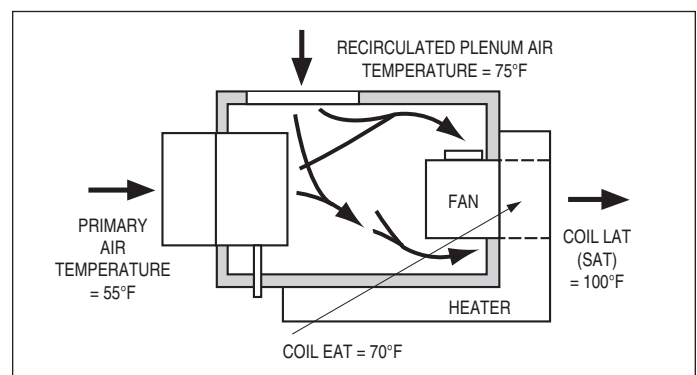

Figure 36. Series Fan Terminal With Electric Heat in Heating Mode. Model 35SE.

Terminal Installation and Application Precautions – Avoiding Common Errors and Problems

Sizing Terminals

Select terminals based upon recommended air volume ranges. The pressure independent terminals main feature is its ability to accept factory calibrated minimum and maximum airflow limits that correspond to the designers space load and ventilation requirements for a given zone.

A common misconception is that oversizing a terminal will make the unit operation quieter. In reality, the terminal damper will have to operate in a pinched-down condition most of the time which may actually increase noise levels to the space. Control accuracy may suffer as the terminal is only using a fraction of its total damper travel or stroke. In addition, the low inlet velocities may be insufficient to produce a readable signal for the sensor and reset controller. This means minimum settings may not hold with a resultant loss of control accuracy and undesirable hunting.

The recommended selection for maximizing performance is to size the terminals maximum airflow limit for 70 – 85% of its rated capacity (approx. 2000 fpm) in accordance with the catalog recommendations. For accurate control the minimum setting guideline is not lower than 20% of the units rated total capacity.

Another problem associated with oversizing terminals with electric heat is again insufficient velocity causing occasional tripping of the airflow safety switch.

Observe Space Restrictions

During the design phase try and ensure terminals are located for ease of installation, optimum performance and maintenance accessibility. Figure 39 shows all of the worst conditions: a convoluted inlet, controls and heating coil connections are restricted as the terminal is against a wall and the outlet restricted condition reduces performance.

Optimize Inlet Conditions

The type of duct and its approach may have a large and adverse impact on both pressure drop and control accuracy. Figure 40 shows several typical poor conditions that generate unwanted turbulence. Although multi-point sensors can compensate to a large degree, good design practice should always prevail. Nailor recommends wherever possible, a straight duct inlet connection with a minimum length of two duct diameters, the same size as the inlet.

Terminal collars are undersized to suit nominal ductwork dimensions. The inlet duct slips over the terminal inlet collar and is fastened and sealed in accordance with job specifications. Never insert a duct inside the inlet collar, control calibration will be adversely affected.

Sometimes it is not possible due to space restrictions to provide an ideal inlet condition. In this case field adjustment of the airflow settings on the velocity controller may be required to compensate. The use of flow straightening devices (equalizing grids) are recommended after short radius elbows that are immediately ahead of the terminal and where terminals are unavoidably tapped directly off the main duct.

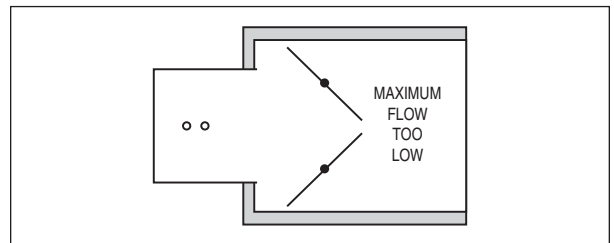

Figure 37. Severe Throttling: Oversized terminals will operate in a near closed position even at maximum airflow. Control accuracy may also suffer.

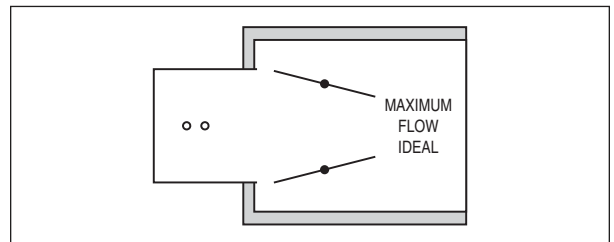

Figure 38. Ideal Throttling: Correctly sized terminal will utilize the majority of its damper travel and improve performance.

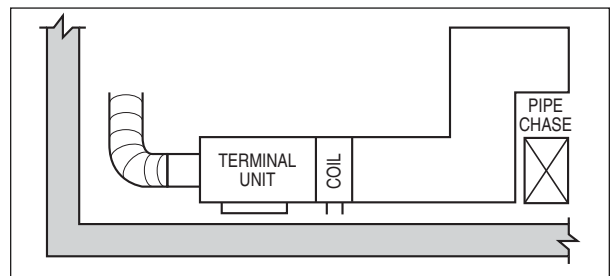

Figure 39. Restricted Installation, Poor Location.

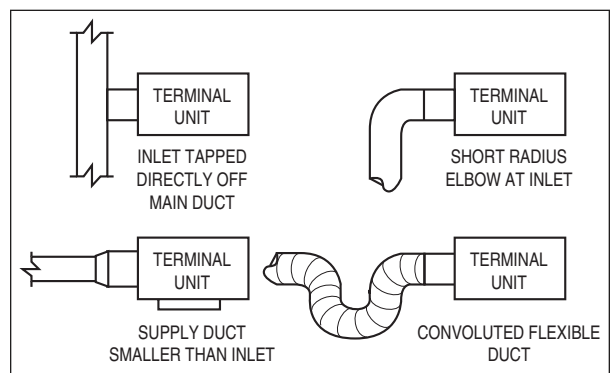

Figure 40. Poor Inlet Conditions.

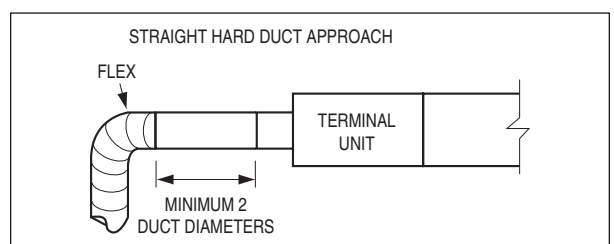

Figure 41. Ideal Inlet Conditions.

Observe Zoning Requirements

Correctly sizing terminals with regard to the physical conditions of the occupied space is vital to ensure acceptable performance. One large terminal serving a space with divided work areas may result in the single thermostat only providing acceptable temperature control where it is located. The other space(s) served may be too cold or too hot if it has differing space load requirements.

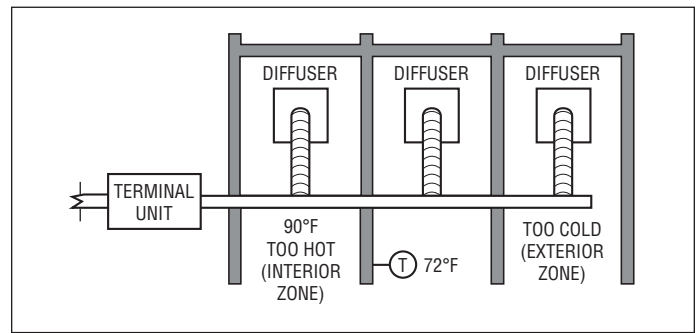

Figure 42. Poor Zone Application.

Optimize Discharge Conditions

Poor discharge duct connections may have an adverse affect on pressure drop. Try and avoid installing tees, transitions and elbows close to the inlet discharge. Avoid long runs of flex and keep short flex runs as straight as possible. Make curves as shallow as possible and ensure entrance condition to diffuser outlet is straight.

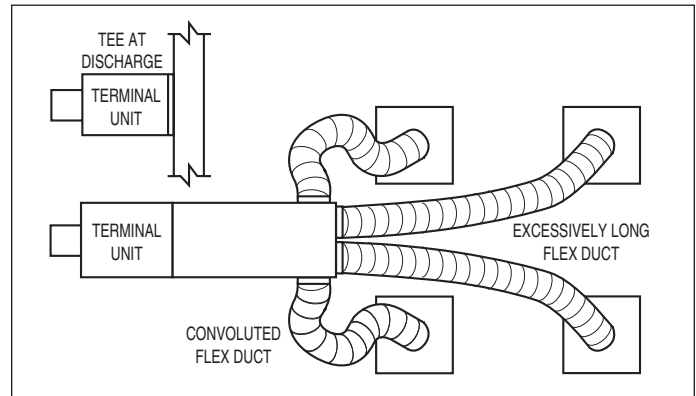

Figure 43. Poor Discharge Conditions.

Non-Compliance with Local Electrical Codes

Some local jurisdictions have more exacting codes than the minimum requirements of national codes such as NEC, UL and CSA. One example is the primary fusing required of the power circuit in some areas.

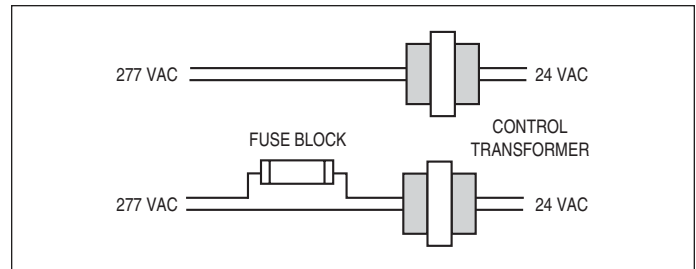

Figure 44. Power circuit fusing is required by some local code authorities.

Power Source Compatibility

Terminals with an electrical power supply such as fan powered terminals and single duct terminals with electric heat should be checked for compatibility with source. Voltage, phase and frequency must match. Where motor voltage differs, the single phase voltage requirement must be tappable from a three phase (4 wire wye) power source.

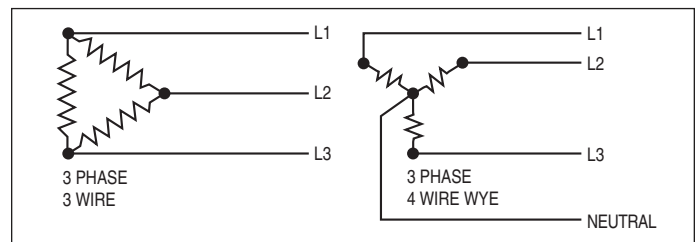

Figure 45. The requirement for three phase electricity must be specified as 3 wire or 4 wire wye.

Avoid Excessive Air Temperature Rise

Terminals with electric or hot water reheat coils should be designed to satisfy load conditions but attention should be paid to the temperature differential (Δt) between the entering room air and ambient temperature. The ASHRAE HVAC Applications handbook recommends a maximum Δt of 15°F (8°C) to avoid possible stratification due to the excessive buoyancy of the warm air and ensure good room mixing and temperature equalization. This also meets ASHRAE Standard 62.1 requirements for Air Change Effectiveness. Higher differentials require a 25% increase in ventilation air.

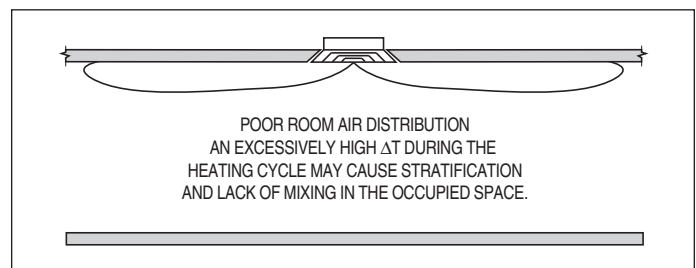

Figure 46. Avoid excessive temperature differentials

Correctly Supported Terminal

Although the basic single duct terminal is light enough that it can be supported by the ductwork in which it is installed, we recommend that each terminal unit be independently supported, especially when accessory modules, such as coils, attenuators, silencers or multiple outlets are present. Hanger straps may be used and screwed directly into the sides or bottom of the unit casing* (Shown: Model D30RW - Single Duct Terminal Unit with Hot Water Heat). Alternately, a carriage made of unistrut may be used, sometimes this is known as a trapeze setup. Support the VAV and any accessories separately** (Shown: Model 3001Q - Single Duct Terminal Unit with Dissipative Silencer). When requested, unit is supplied with field mounted hanger brackets for use with hanger rod up to 3/8" (9.5) dia. Hanger brackets should be screwed into the top of the unit casing*** (Shown: Model D30RWQ - Single Duct Quiet Terminal Unit with Standard Dissipative Silencer and Hot Water Heat and Model D30HQX - Single Duct Exhaust Terminal Unit with Dissipative Silencer). Use the support method prescribed for the rectangular duct in the job specifications.

Larger terminals such as fan powered terminal units should always be independently supported and secured to building structure.

Be careful not to block access panels with straps, all-thread rods or trapeze supports.

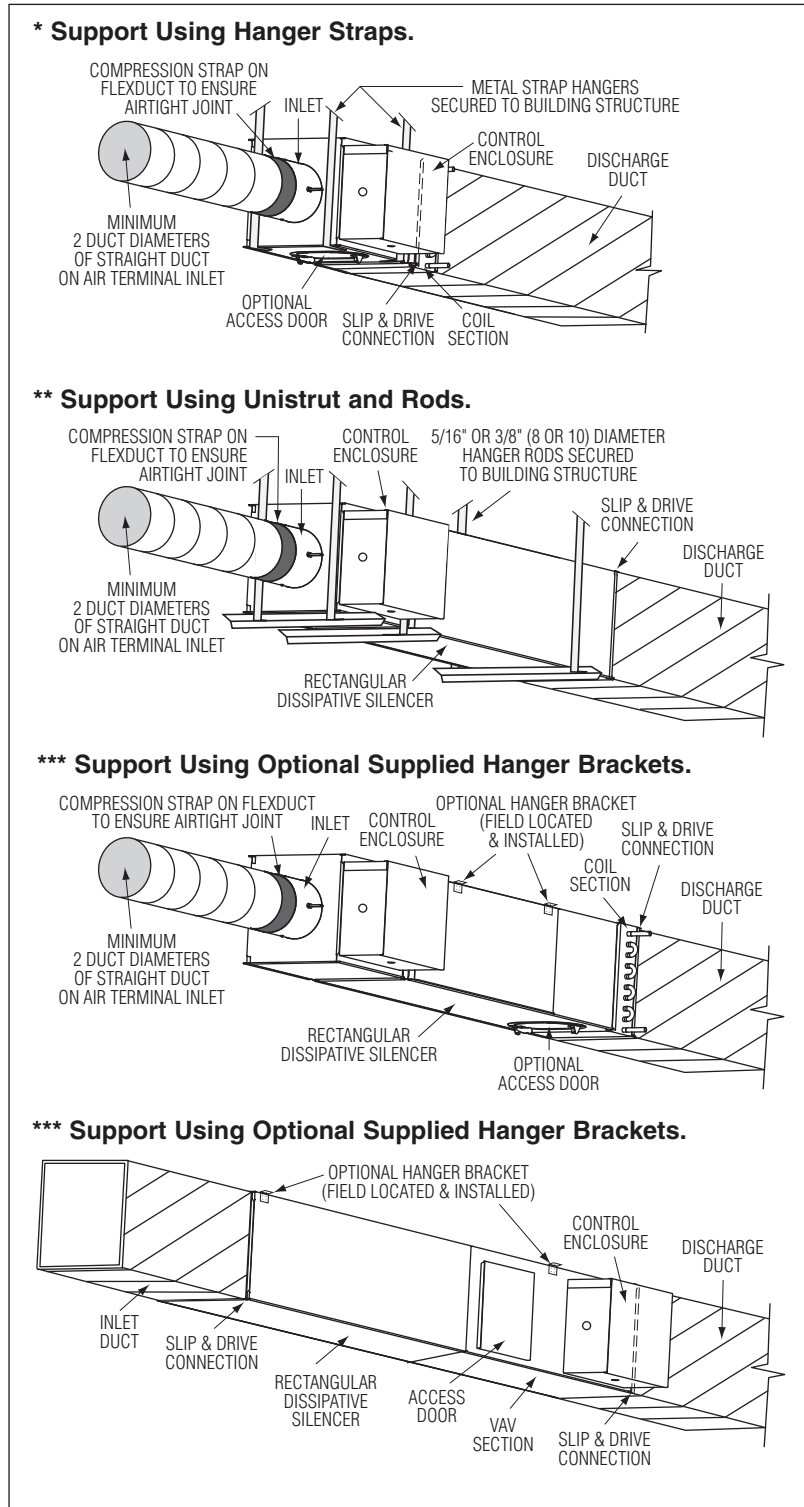

Figure 47. Recommended Terminal Suspension.

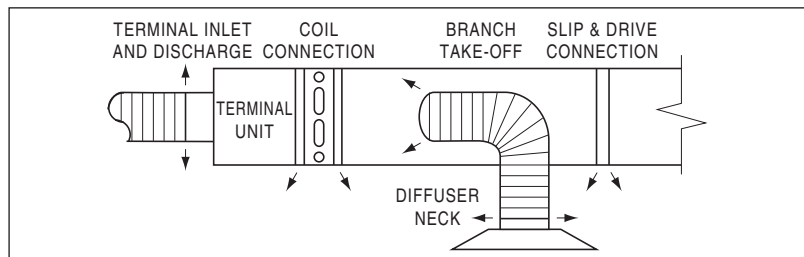

Figure 48. Possible Air Leakage Points.

Minimize Duct Leakage

To prevent excess air leakage and minimize energy waste, all joints should be sealed with an UL approved duct sealer. Most leakage can be avoided by practicing good fabrication and installation techniques, particularly upstream of the terminal which may invariably be required to hold significantly higher pressures than downstream of the terminal.

Estimating Sound Levels

1. Noise Criteria - NC

NC level or Noise Criteria is a widely accepted and popular way for many engineers to estimate and predict room noise levels. NC levels are also used as a rating scale for equipment that is expected to operate within certain levels.

Sound Power levels for terminal units are expressed over six octave bands: 2, 3, 4, 5, 6 and 7. Each octave band is defined by the center frequency within that particular band. Frequency is measured in Hz. Each of these respective frequencies and octave bands are shown in Table 1.

Octave Band	2	3	4	5	6	7
Center Frequency	125	250	500	1000	2000	4000

Table 1: Octave band designation

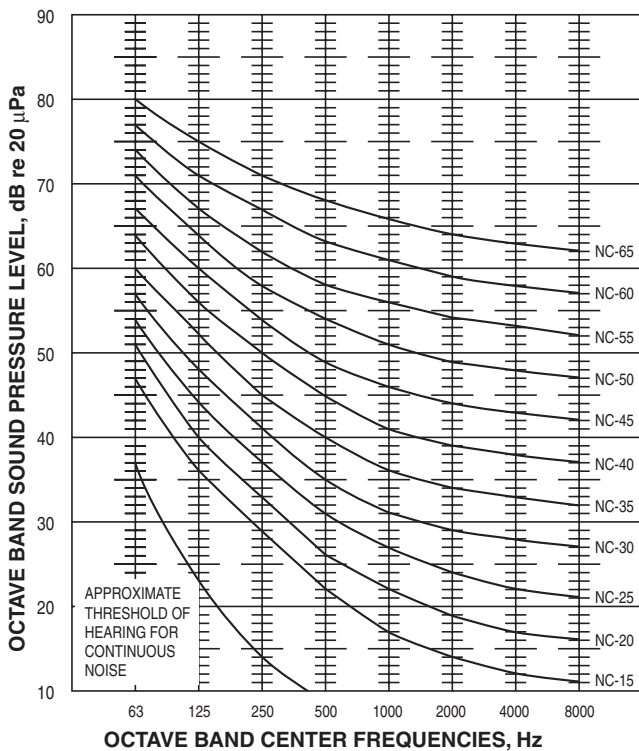

Figure 1: NC (Noise Criteria) Curves for Specifying the Design Level in Terms of the Maximum Permissible Sound Pressure Level for Each Frequency Band

When deriving NC levels for terminal units, the pressure levels are plotted on a standard NC Chart (Figure 1). The highest pressure level when measured against the NC curves, regardless of the octave band, determines the NC of the unit. Table 2 shows the ASHRAE recommended RC and NC levels for several different types of space. RC (Room Criteria) Levels are a newer method of evaluating sound performance of an HVAC system as a whole in order to achieve a well balanced, bland-sounding spectrum. While RC ratings may be an excellent tool for evaluating all sound in a space, they are not practical as a means of rating air terminals. For a full explanation, consult the ASHRAE Applications Handbook Chapter on Sound and Vibration Control and AHRI Standard 885.

Room Type	RC (N) or NC Level ^{a,b}
Residences, Apartments, Condominiums	25 – 35
Hotels/Motels	
Individual rooms or suites	25 – 35
Meeting/banquet rooms	25 – 35
Corridors, lobbies	35 – 45
Service/support areas	35 – 45
Offices Buildings	
Executive and private offices	25 – 35
Conference rooms	25 – 35
Teleconference rooms	25 (max)
Open-plan offices	30 – 40
Corridors and lobbies	40 – 45
Hospitals and Clinics	
Private rooms	25 – 35
Wards	30 – 40
Operating rooms	25 – 35
Corridors and public areas	30 – 40
Performing Arts Spaces	
Drama theaters	25 (max)
Concert and recital halls ^c	25 (max)
Music teaching studios	25 (max)
Music practice rooms	35 (max)
Laboratories (with fume hoods)	
Testing/research, minimal speech communication	45 – 55
Research, extensive telephone use	40 – 50
speech communication	
Group teaching	35 – 45
Church, Mosque, Synagogue	
General assembly	25 – 35
With critical music programs ^c	
School	
Classrooms up to 750 ft ² (69.68 m ²)	25 – 30
Classrooms over 750 ft ² (69.68 m ²)	25 – 30
Large lecture rooms w/out speech amplification	25 (max)
Libraries	30 – 40
Courtrooms	
Unamplified speech	25 – 35
Amplified speech	30 – 40
Indoor Stadiums, Gymnasiums	
Gymnasiums and natatoriums ^e	40 – 50
Large seating-capacity spaces with speech amplification ^e	45 – 55

Table 2: Design Guidelines for HVAC-Related Background Sound in Rooms

^aThe values and ranges are based on judgment and experience, not on quantitative evaluations of human reactions. They represent general limits of acceptability for typical building occupancies. Higher or lower values may be appropriate and should be based on a careful analysis of economics, space use and user needs.

^bWhen quality of sound in the space is important, specify criteria in terms of RC(N). If the quality of the sound in the space is of secondary concern, the criteria may be specified in terms of NC or NCB levels of similar magnitude.

^cAn experienced acoustical consultant should be retained for guidance on acoustically critical spaces (below RC 30) and for all performing arts spaces.

^dHVAC-related sound criteria for schools, such as those listed in this table, may be too high and impede learning by children in primary grades whose vocabulary is limited. Some educators and others believe that the HVAC-related background sound should not exceed RC 25 (N).

^eRC or NC criteria for these spaces need only be selected for the desired speech and hearing conditions.

Most manufacturers list raw sound power levels for a wide range of operating conditions for their equipment. To predict sound pressure levels within a space, the Air Conditioning, Heating, and Refrigeration Institute (AHRI) has developed AHRI Standard 885. "Procedure for Estimating Occupied Space Sound Levels in the Application of Air Terminals and Air Outlets." It has been widely accepted. The standard displays several paths that sound could take into the space. Each of these paths must be evaluated. The attenuation in each octave band is calculated and subtracted from the manufacturers sound power levels.

The AHRI Standard 885 forms the basis for the sound estimation guidelines and examples presented on the following pages. For a more detailed analysis, refer to AHRI Standard 885, the current ASHRAE Fundamentals Handbook, chapter 8 and the current ASHRAE HVAC Applications Handbook, chapter 48.

2. Environmental Adjustment Factor

According to AHRI Standard 885, an environmental adjustment factor must be applied to manufacturer's data if the sound power data has been obtained in accordance with AHRI Standard 880.

Sound power levels obtained in accordance with Standard 880 are based on a free field calibration of the reference sound source in accordance with ANSI S12.31-90. "Precision Methods for the Determination of Sound Power Levels of Broad-Band Noise Sources in Reverberation Rooms." Real rooms at low frequencies behave acoustically more like reverberant rooms than open spaces (free field). Therefore it is necessary to adjust power levels obtained in accordance with AHRI Standard 880 by the Environmental Adjustment Factor listed in Table 3. These factors are subtracted from the manufacturer's sound power level data. Nailor tests all terminal units in accordance with ANSI/ASHRAE Std. 130 and AHRI Standard 880; therefore these corrections should be applied when estimating the sound power in occupied spaces.

Octave Band	125	250	500	1000	2000	4000	8000
dB Reduction	2	1	0	0	0	0	0

Table 3: Environmental Adjustment Factor

Ref: AHRI Standard 885, Appendix C, Table C1, page 41.

3. Sound Paths

In order to estimate the sound power level in the occupied space, one must first identify the sound source and then determine by which paths the sound enters the occupied space. The example in Figure 2 illustrates a fan powered terminal as the sound source and identifies all the sound paths. These are:

1. Upstream Duct Breakout Radiated

This is the sound generated by the terminal unit which is transmitted through the upstream ductwork.

2. Casing and Induction Inlet Radiated

This is the sound transmitted through the terminal unit casing and the induction air inlet on a fan powered terminal.

3. Discharge Duct Breakout Radiated

This is the sound generated by the terminal unit which is transmitted through the downstream ductwork walls. This occurs at several locations.

4. Outlet Discharge

This is the sound generated by the terminal which travels down the ductwork and escapes at the air outlet.

5. Outlet Generated

This is the sound generated by the air outlet (grille, diffuser) itself.

While a discerning engineer should evaluate each of these paths when designing a building, the discussion and examples that follow will only consider the radiated sound from the terminal and the discharge sound emitted into the room at the diffuser. These are a function of terminal performance and usually the most significant and therefore critical sound paths requiring analysis.

Upstream and discharge duct breakout radiated noise paths are not usually a contributing factor to the occupied sound level so long as care is taken in the design and installation of the ductwork. However, a detailed analysis of these paths is covered in AHRI Standard 885.

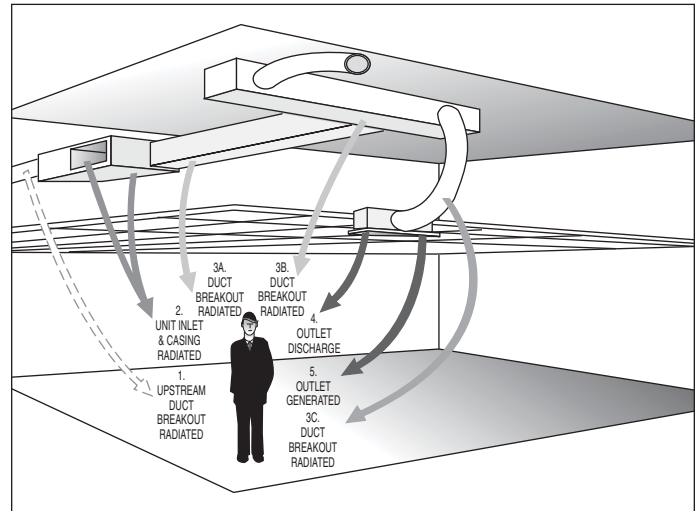

Figure 2: Typical Sound Paths for a Terminal Unit (Fan Powered Type illustrated)

4. Radiated Sound

Fig. 3 illustrates the sound path for casing and inlet radiated sound. The attenuation factors that apply to this sound path are Ceiling/Space Effect and Environmental Adjustment Factor (which was presented earlier).

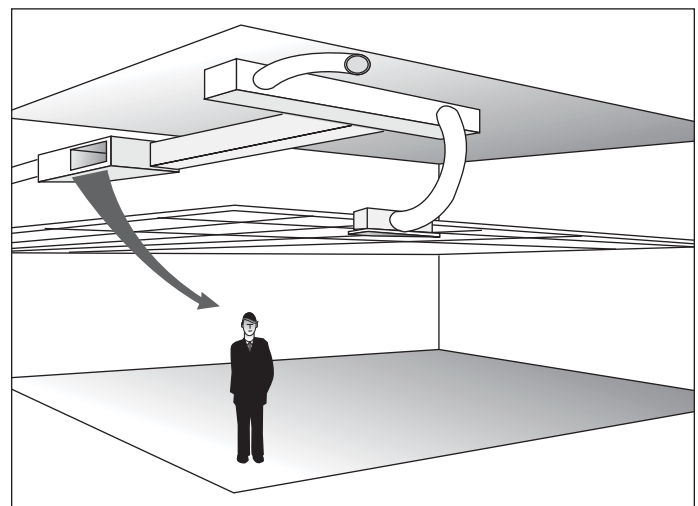

Figure 3: Radiated Sound Path

Ceiling/Space Effect

To calculate the sound level in a space resulting from a sound source located in the ceiling cavity, a transfer function is provided which is used to calculate the sound pressure in the space. This transfer function includes the combined effect of the absorption of the ceiling tile, plenum absorption and room absorption. This procedure is based on research conducted under ASHRAE research project RP-755, approved June 1997. The procedure assumes the following conditions:

- a. The plenum is at least 3 feet (0.9 meters) deep.
- b. The Plenum space is either wide [over 30 feet (9 meters)] or lined with insulation.
- c. The ceiling has no significant penetrations directly under the units.

Table 4 provides typical values for ceiling space effect of several ceiling types. For conditions other than these, sound transfer functions may be less. For instance, in a shallow plenum, 2 ft. (0.6 m) or less, tests have shown that sound in the space can be expected to be 5 – 7 dB louder below 500 Hz (4th Octave Band).

Octave Band	125	250	500	1000	2000	4000
Mineral Fiber Tile 5/8", 20lb/ft ³	16	18	20	26	31	36
Glass Fiber Tile-2", 4 lb/ft ³	17	18	21	25	29	35
Solid Gypsum Board – 5/8", 43 lb/ft ³	23	27	27	29	29	30

Table 4: Ceiling/Space Effect Attenuation Values

Ref: AHRI Standard 885, Appendix D, Table D14, Page 56.

5. Discharge Sound

Figure 4 illustrates the sound path for outlet discharge sound. The attenuation factors which apply to this sound path are:

- Environmental Adjustment Factor
- Lined Duct Insertion Loss
- Elbow and Tee Loss
- Branch Power Division
- Lined Flexible Duct Insertion Loss
- End Reflection Factor
- Space Effect

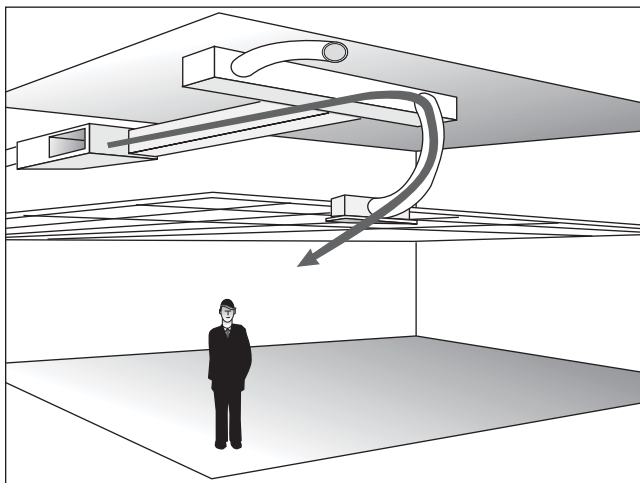

Figure 4: Discharge Sound

Lined Duct Insertion Loss

As sound travels down a duct, some of its energy is absorbed by the duct and its lining. Some of the energy is also radiated or transmitted through the duct walls. Consequently, the sound pressure level at the discharge end of the duct will be lower than at the inlet of the duct.

Duct Insertion Loss is affected by the size of the duct at the discharge of the terminal unit. Table 5 shows several different sizes of discharge ducts that are commonly used for Nailor terminal units and their associated attenuation factors for each octave band in dB/linear foot when internally lined with 1" (25) thick, 1 1/2 lb/ft³ density insulation.

Nominal Duct Dimension inches (mm)	Octave Band					
	125	250	500	1000	2000	4000
10 x 10 (254 x 254)	0.4	1.0	2.1	4.4	4.7	3.1
12 x 12 1/2 (305 x 318)	0.4	0.8	1.9	4.0	4.1	2.8
14 x 12 1/2 (356 x 318)	0.3	0.8	1.8	3.9	3.7	2.6
18 x 12 1/2 (458 x 318)	0.3	0.7	1.7	3.7	3.5	2.5
24 x 12 1/2 (610 x 318)	0.3	0.6	1.6	3.3	2.9	2.2
28 x 12 1/2 (711 x 318)	0.3	0.6	1.7	3.5	3.0	2.3
38 x 12 1/2 (966 x 445)	0.2	0.4	1.3	2.7	2.0	1.7
14 x 14 (356 x 356)	0.3	0.8	1.8	3.7	3.7	2.6
15 x 15 (381 x 381)	0.3	0.7	1.7	3.6	3.3	2.4
16 x 16 (406 x 406)	0.3	0.7	1.7	3.5	3.3	2.4
28 x 18 (711 x 457)	0.2	0.5	1.4	3.0	2.4	1.9
18 x 16 (457 x 406)	0.3	0.6	1.7	3.5	3.2	2.3
22 x 16 (558 x 406)	0.3	0.6	1.6	3.3	2.9	2.2
16 x 12 (406 x 305)	0.3	0.8	1.8	3.8	3.7	2.6
24 x 15 (610 x 318)	0.3	0.6	1.6	3.3	2.9	2.2
50 x 15 (1270 x 381)	0.2	0.5	1.4	2.9	2.4	1.9
40 x 12 (1016 x 305)	0.3	0.6	1.6	3.3	2.9	2.2
12 x 10 (305 x 254)	0.4	0.9	2.0	4.2	4.4	2.9
14 x 10 (356 x 254)	0.4	0.8	1.9	4.1	4.2	2.8
28 x 10 (711 x 254)	0.3	0.7	1.7	3.6	3.3	2.4
40 x 9 (1016 x 229)	0.3	0.6	1.6	3.3	2.9	2.2
24 x 8 (610 x 203)	0.4	0.8	1.9	4.0	4.1	2.8

Table 5: Sound Insertion Loss/Attenuation in Straight Lined Metal Ducts, dB/ft.

Ref: AHRI Standard 885, Appendix D, Table D8, page 50.

Elbow and Rectangular Tee Loss

Lined and unlined rectangular elbows provide attenuation as per Tables 6a & 6b. Tee fittings can be considered as if they are two elbows side by side, where mean duct width for estimation purposes from Tables 6a & 6b is taken as being 1/2 of the actual duct width. See Figure 5.

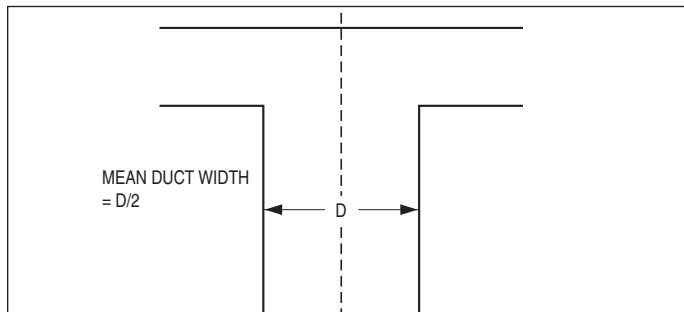

Figure 5: Tee Fitting Loss.

	Duct Width Inches (mm)	Octave Band					
		125	250	500	1000	2000	4000
Unlined Duct	5 – 10 (100 – 125)	0	0	1	5	8	4
	11 – 20 (260 – 700)	1	5	5	8	4	3
	21 – 40 (710 – 1000)	5	5	8	4	3	3
	41 – 80 (1010 – 2000)	5	8	4	3	3	3
Lined Duct	5 – 10 (100 – 125)	0	0	1	6	11	10
	11 – 20 (260 – 700)	1	6	6	11	10	10
	21 – 40 (710 – 1000)	6	6	11	10	10	10
	41 – 80 (1010 – 2000)	6	11	10	10	10	10

Table 6a: Insertion Loss of Unlined and Lined Elbows without Turning Vanes, db

	Duct Width Inches (mm)	Octave Band					
		125	250	500	1000	2000	4000
Unlined Duct	5 – 10 (100 – 125)	0	0	1	4	6	4
	11 – 20 (260 – 700)	1	4	6	4	4	4
	21 – 40 (710 – 1000)	4	6	6	4	4	4
	41 – 80 (1010 – 2000)	4	6	6	4	4	4
Lined Duct	5 – 10 (100 – 125)	0	0	1	4	7	7
	11 – 20 (260 – 700)	1	4	7	7	7	7
	21 – 40 (710 – 1000)	4	7	7	7	7	7
	41 – 80 (1010 – 2000)	4	7	7	7	7	7

Table 6b: Insertion Loss of Unlined and Lined Elbows with Turning Vanes, db

Ref: AHRI Standard 885, Appendix D, Table D12, page 54.

Branch Power (Flow) Division

This calculation should be performed for each junction, where a division of airflow exists, such as tees and branch takeoffs. At Branch takeoffs, acoustic energy is distributed between the branches and/or the main duct in accordance with the ratio of the branch cross sectional area to the total cross sectional area of all ducts leaving the takeoff. Acoustic energy is divided in proportion to the flow division. Table 7 lists the attenuation at various percentages of total flow carried by the branch ductwork.

% of Total Flow	60	50	40	30	20	15	10	5
dB Attenuation	2	3	4	5	7	8	10	13

Table 7: Power Level Division at Branch Takeoffs

Ref: AHRI Standard 885, Appendix D, Table D2, page 43.

Lined Flexible Duct Insertion Loss

Insertion loss values for lined flexible duct are listed in Table 8. Unlined flexible duct should be conservatively modeled as unlined hard duct, which AHRI Standard 885 regards as negligible.

Non-metallic insulated flexible ducts can significantly reduce airborne noise. Recommended duct lengths are normally from 3 to 6 ft. (0.9 to 1.8 m). Care should be taken to keep flexible ducts straight; bends should have as long a radius as possible. While an abrupt bend may provide some additional insertion loss, the airflow generated noise associated with the airflow in the bend may be unacceptably high. Because of potentially high duct breakout sound levels associated with flexible ducts, care should be exercised when using flexible ducts, above sound sensitive spaces. The data in Table 8 is based on solid core (non-perforated or woven), 1" (25) thick insulation and plastic jacket.

Duct Dia. inches (mm)	Duct Length ft. (m)	Octave Band					
		125	250	500	1000	2000	4000
4 (100)	3 (3.0)	5	4	12	20	23	15
	5 (1.5)	7	5	16	24	27	18
	10 (3.0)	10	9	27	33	38	24
5 (125)	3 (0.9)	5	5	13	19	21	13
	5 (1.5)	6	7	17	23	25	16
	10 (3.0)	10	12	28	33	37	23
6 (150)	3 (0.9)	5	6	13	17	19	11
	5 (1.5)	6	9	18	22	24	15
	10 (3.0)	10	15	28	33	35	22
7 (175)	3 (0.9)	5	7	14	16	17	10
	5 (1.5)	6	10	18	21	22	13
	10 (3.0)	10	16	29	33	34	21
8 (200)	3 (0.9)	4	7	14	15	16	8
	5 (1.5)	6	10	18	20	21	12
	10 (0.9)	10	18	29	32	32	20
10 (250)	3 (0.9)	4	7	14	12	13	6
	5 (1.5)	5	11	18	18	18	9
	10 (3.0)	9	19	28	31	29	18
12 (300)	3 (0.9)	3	6	12	10	11	4
	5 (1.5)	4	9	16	16	15	7
	10 (3.0)	8	17	26	29	26	15
14 (350)	3 (0.9)	2	4	10	9	9	4
	5 (1.5)	3	7	14	14	13	6
	10 (3.0)	6	13	23	26	23	12
16 (400)	3 (0.9)	1	0	8	8	8	4
	5 (1.5)	2	2	11	12	11	5
	10 (3.0)	4	7	19	24	20	8

Table 8: Lined Flexible Duct Insertion Loss, dB

Ref: AHRI Standard 885, Appendix D, Table D9, page 51.

End Reflection Factor

When plane wave sound passes from a small space such as a duct into a large space the size of a room, a certain amount of sound is reflected back into the duct, significantly reducing low frequency sound. See Table 9. The values of Table 9 apply to straight runs of duct entering a room, therefore caution should be exercised when a condition differs drastically from the test conditions used to derive the table.

Duct Dia. inches (mm)	Octave Band					
	125	250	500	1000	2000	4000
6 (150)	12	7	3	1	0	0
8 (200)	10	5	2	1	0	0
10 (250)	8	4	1	0	0	0
12 (300)	7	3	1	0	0	0
16 (400)	5	2	1	0	0	0

Table 9: End Reflection Loss/Per ASHRAE RP 1314, dB.

Ref: AHRI Standard 885, Appendix D, Table D13, page 55.

Space Effect

Space effect is the attenuation of sound power entering a space as a result of the absorption properties of the space and the distance from the sound source to the receiver location (recipient). A sound source terminating in the occupied space is assumed to be a point source. The calculation of the sound pressure level L_p in rooms for the entering sound power L_w can be accomplished using the Schultz equation:

$$L_p = L_w - 10 \log r - 5 \log V - 3 \log f + 25$$

Where:

L_p = sound pressure level in dB, re 20 μ Pa

L_w = sound power level in dB, re 10⁻¹² watts

r = shortest distance in ft. from noise source to receiver

V = room volume in ft.³

f = octave band center frequency in Hz.

Since Space Effect = $L_w - L_p$, then,

$$\text{Space Effect} = 10 \log r + 5 \log V + 3 \log f \text{ (Hz)} - 25$$

Table 10 provides space effect values for several typical conditions that may be used for easy reference. Attenuation values for Space Effect should be used for both the discharge sound traveling from an air terminal through the supply ductwork and entering the room through the diffuser and separately for the air outlet (diffuser) itself.

In order to compare the noise levels of different systems at the design stage where exact room dimensions are not known, the following default room values are suggested.

1. Small Room, Single Outlet 1,500 ft³ (42 m³)
2. Large Room, Four Outlets 8,000 ft³ (220 m³)

It is also recommended that noise level predictions be made at heights 5 ft. (1.5 m) above the floor when no specific height is specified.

Room Volume	Distance from Source	Octave Band					
		125	250	500	1000	2000	4000
2000 ft ² (56 m ³)	5 ft. (1.5 m)	-5	-6	-7	-7	-8	-9
	10 ft. (3.0 m)	-8	-9	-10	-11	-11	-12
	15 ft. (4.6 m)	-10	-10	-11	-12	-13	-14
2500 ft ² (69 m ³)	5 ft. (1.5 m)	-5	-6	-7	-8	-9	-10
	10 ft. (3.0 m)	-8	-9	-10	-11	-12	-13
	15 ft. (4.6 m)	-10	-11	-12	-13	-14	-14
3000 ft ² (83 m ³)	5 ft. (1.5 m)	-6	-7	-7	-8	-9	-10
	10 ft. (3.0 m)	-9	-10	-10	-11	-12	-13
	15 ft. (4.6 m)	-10	-11	-12	-13	-14	-15
5000 ft ² (140 m ³)	5 ft. (1.5 m)	-7	-8	-9	-9	-10	-11
	10 ft. (3.0 m)	-10	-11	-12	-12	-13	-14
	15 ft. (4.6 m)	-12	-12	-13	-14	-15	-16

Table 10: Space Effect, Point Source, dB.

Ref: AHRI Standard 885, Appendix D, Table D16, page 57.

6. Outlet Generated Sound

This is the sound generated by the air outlet (diffuser) itself and is considered a point source. The attenuation factor which applies to this sound path is space effect (from the Schultz equation described on page G26). The attenuation allowances in Table 10 may be used for a single sound source in the room.

Due to the large number and diverse range of model sizes and airflow rating points that must be presented, in order to simplify selection and reduce the amount of documented performance data, manufacturers of grilles, registers, diffusers and other air outlet devices publish a single NC sound rating, rather than presenting the individual sound power levels in each octave band. Published NC ratings commonly subtract 10 dB from measured sound power levels in each octave band to account for an average room attenuation (absorption). As discussed earlier, under environmental adjustment factor and space effect (Tables 3 and 10), this will be a valid assumption for a number of combinations of room volume and distance from the source.

A conservative estimate of outlet generated sound power levels can be obtained by assuming the individual octave band sound pressure levels associated with the published NC rating (presented in Table 11), and then adding to these values in each octave band, the manufacturer's assumed (10 dB) room absorption.

For a closer approximation of diffuser sound power when only NC is known, one can assume that the sound power for the diffuser in the 5th octave band (1,000 Hz) is equal to the reported NC plus 10 dB, the 4th band (500 Hz) is 3 greater than this and the 6th band (2000 Hz) is 5 less. The 2nd, 3rd and 7th octave bands do not significantly contribute to the space sound level and can be ignored.

NC	Octave Band					
	125	250	500	1000	2000	4000
15	36	29	22	17	14	12
20	40	33	26	22	19	17
25	44	37	31	27	24	22
30	48	41	35	31	29	28
35	52	45	40	36	34	33
40	56	50	45	41	39	38
45	60	54	49	46	44	43
50	64	58	54	51	49	48

Table 11: Tabular Representation of NC Curves, dB

Ref: AHRI Standard 885, Table 13, page 32

Multiple Sound Sources

Method A. Logarithmic addition of single sound sources using Schultz Equation for Space Effect.

Manufacturers published NC sound data is for a single source. Allowances must therefore be made for multiple outlets in a single space, since the overall noise level may be higher. Table 12 lists the additive effect of multiple outlets when their sound levels are equal.

No. of Outlets	1	2	3	4	8	10	20
dB addition	0	3	5	6	9	10	13

Table 12: Sound allowance for multiple outlets of equal sound level.

When the sound at each outlet is not equal, they must be added in pairs. Sound power and pressure levels expressed in decibels (dB) are logarithmic functions and are therefore not added directly. Figure 6 provides a simple means of estimating the result.

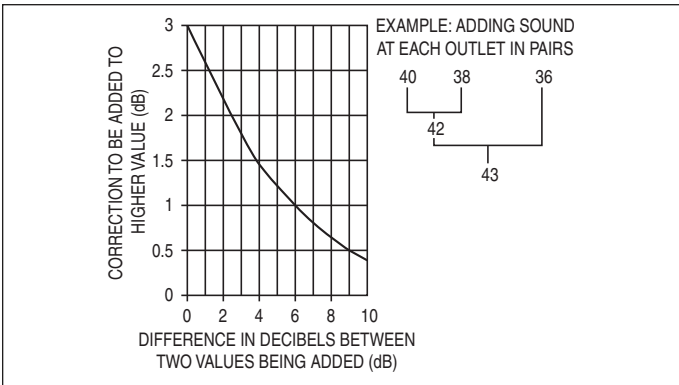

Figure 6: dB Addition.

Ref: AHRI Standard 885, Figure 4, page 11.

For a large open space with a large number of diffuser outlets, consider an area of 400 to 600 sq. ft. with an aspect ratio no less than 1 to 2, as the maximum area where the number of diffusers present contribute to the overall sound level.

Method B. Distributed Array Space Effect.

The above calculation procedure can be tedious and time consuming for a large number of outlets. The Schultz equation must be used to calculate the sound pressure levels for each individual air outlet at their specific location in the room relative to the receiver location and then logarithmically added.

For the special case of a distributed ceiling array of air outlets where all of the sources have the same L_w , the calculation can be simplified by using the following equation for space effect:

$$S_a \text{ (Distributed Ceiling Array Effect)} = L_w - L_p$$

Where:

$$S_a = 5 \log x + 28 \log h - 1.13 \log N + 3 \log f - 31 \text{ dB}$$

x = ratio of floor area served by each outlet to the square of the ceiling height, ft.

h = ceiling height in ft.

N = number of evenly spaced outlets in the room, minimum four.

f = octave band center frequency in Hz.

Data based on the above calculation is presented in Table 13 for easy reference, based upon an array of four outlets for four different room heights with three different outlet areas. This table does not apply for a row of linear diffusers.

Area/ Diffuser	Ceiling Height	Octave Band					
		125	250	500	1000	2000	4000
200 ft ² (18.6 m ²)	8 ft. (2.0 m)	2	3	4	5	6	7
300 ft ² (27.8 m ²)		3	4	5	6	7	8
400 ft ² (37.2 m ²)		4	5	6	7	7	8
200 ft ² (18.6 m ²)	9 ft. (3.0 m)	3	4	5	6	7	8
300 ft ² (27.8 m ²)		4	5	6	7	8	9
400 ft ² (37.2 m ²)		5	6	7	8	8	9
200 ft ² (18.6 m ²)	10 ft. (3.0 m)	4	5	6	7	8	9
300 ft ² (27.8 m ²)		5	6	7	8	9	10
400 ft ² (37.2 m ²)		6	7	7	8	9	10
200 ft ² (18.6 m ²)	12 ft. (3.6 m)	6	6	7	8	9	10
300 ft ² (27.8 m ²)		6	7	8	9	10	11
400 ft ² (37.2 m ²)		7	8	9	10	11	12

Table 13. Room Sound Attenuation for an Outlet Array, 4 outlets, dB.

Ref: AHRI Standard 885, Appendix D, Table D17, page 58.

Example 1:

Determining Sound Pressure Levels at Receiver Location from Radiated and Discharge Paths.

A size 4 – 12 Model 35SST "STEALTH™" fan powered terminal unit is selected to deliver 1100 cfm at 0.5" w.g. inlet static pressure, with 0.25" w.g. downstream resistance. The unit serves four rooms, each with its own supply outlet with the distribution ductwork as illustrated in Figure 7. The terminal unit is located in the ceiling plenum above a mineral fiber tile ceiling in one of the rooms.

The results are tabulated in Table 14 below – radiated sound being applicable only for the room above which the terminal is located and discharge sound applicable to each room.

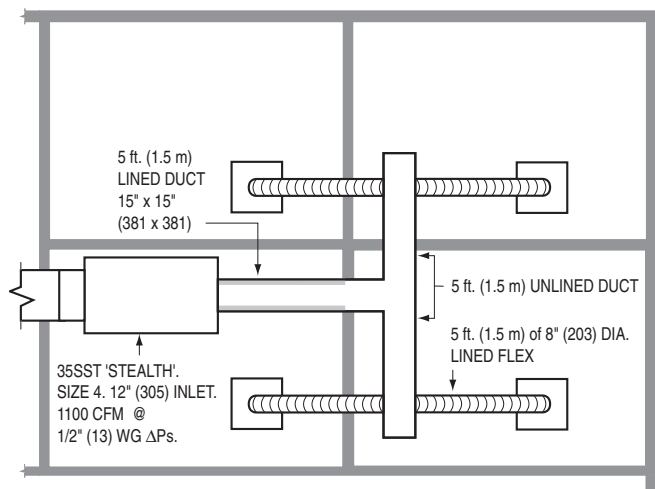

Figure 7: Illustration of working Example 1.

Individual room size: 18 ft. L x 15 ft. W x 9 ft. H (2430 ft.³).

		Octave Band						
		2	3	4	5	6	7	
Radiated Sound Path								
L _{w1} Model 35SST "STEALTH™"		68	60	53	47	42	38	
Environmental / Space Adjustment Factor	(Table 3)	-2	-1	0	0	0	0	
Ceiling / Space Effect	(Table 4)	-16	-18	-20	-26	-31	-36	
L _p , Radiated sound at receiver location		50	41	33	21	11	2	(NC = 32)
Discharge Sound Path								
L _w , Model 35SST "STEALTH™"		77	74	70	69	65	63	
Environmental Adjustment Factor	(Table 3)	-2	-1	0	0	0	0	
5' Lined Duct, 15" x 15"	(Table 5)	-2	-4	-9	-18	-17	-12	
Rectangular tee (D/2 = 7½")	(Table 6a)	0	0	-1	-4	-6	-4	
Branch Power Division (50%)	(Table 7)	-3	-3	-3	-3	-3	-3	
5' Unlined Duct		0	0	0	0	0	0	
5' Lined Flex Duct, 8" dia.	(Table 8)	-6	-10	-18	-20	-21	-12	
Branch Power Division (50%)	(Table 7)	-3	-3	-3	-3	-3	-3	
End Reflection	(Table 9)	-10	-5	-2	-1	0	0	
Space Effect V = 2500 ft ³ , r = 5 ft	(Table 10)	-5	-6	-7	-8	-9	-10	
L _{p1} Discharge sound at receiver location		46	42	12	14	6	19	(NC = 31)

Table 14: Resultant Radiated and Discharge Sound Pressure Levels due to terminal unit for Example 1.

Example 2:

Determining Sound Pressure Level at Receiver Location from Air Outlet Sound Path.

Let us assume the same terminal selection and operating conditions as in the previous Example 1, but instead of supplying four rooms, the terminal is now supplying two larger rooms, each supplied by two diffusers. (Figure 8).

The diffusers selected are Nailor Model RNS, 24" x 24" (610 x 610) ceiling module, 8" (203) dia. neck, each handling 275 cfm (1100 ÷ 4). From Air Distribution Catalog; NC = 20.

Octave Band	2	3	4	5	6	7
NC 20 Sound Power (Table 11)				22		
10 dB add to 5th band (room absorption)				+10		
4th band=5th+3. 6th band=5th-5			35	32	27	
Env. Adjustment Factor (Table 3)			0	0	0	
Space Effect * (Table 10)			-9	-9	-10	
Two Outlets (Table 12)			+3	+3	+3	
L _p , Outlet Sound at Receiver Location (NC=24)			29	26	20	

* Space Effect: V = 5000 ft.³, r = 5 ft.

Table 15: Air Outlet Sound Path resultant Sound Pressure Levels for Example 2.

Example 3:

Determining Total Overall Sound Pressure Level at Receiver Location.

Using the same terminal selection, operating conditions, room layout and diffuser selection as in Example 2 above, the

contributions of the critical sound paths must be combined to obtain the total L_p at the receiver location. The discharge and radiated sound paths are modeled in a similar fashion to Example 1, but with adjustments for room size and number of outlets.

Octave Band	2	3	4	5	6	7
L _w , Model 35SST "STEALTH™"	68	60	53	47	42	38
Env. Adjustment Factor (Table 3)	-2	-1	0	0	0	0
Ceiling/Space Effect (Table 4)	-16	-18	-20	-26	-31	-36
L _p , Radiated Sound at Receiver Location (NC=32)	50	41	33	21	11	2

Table 16: Radiated Sound Path resultant Sound Pressure Levels due to terminal unit for Example 3.

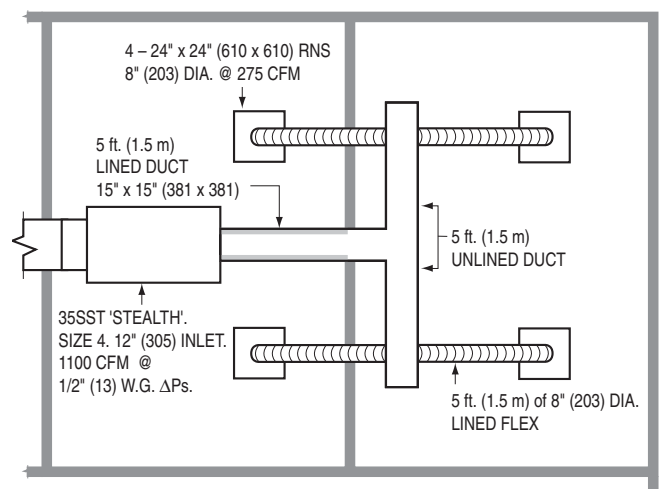

Figure 8: Illustration of working Example 2 and 3. Individual room size = 30 ft. L x 18 ft. W x 9 ft. H (4860 ft.³).

Octave Band	2	3	4	5	6	7
Lw, Model 35SST "STEALTH™"	77	74	70	69	65	63
Env. Adjustment Factor (Table 3)	-2	-1	0	0	0	0
5' Lined Duct 15" x 15" (Table 5)	-2	-4	-9	-18	-17	-12
Rectangular Tee (Table 6a)	0	0	-1	-4	-6	-4
Branch Power Division (50%) (Table 7)	-3	-3	-3	-3	-3	-3
5' Unlined Duct	0	0	0	0	0	0
5' Lined Flex, 8" Dia. (Table 8)	-6	-10	-18	-20	-21	-12
Branch Power Division (Table 7)	-3	-3	-3	-3	-3	-3
End Reflection (Table 9)	-10	-5	-2	-1	0	0
Space Effect* (Table 10)	-7	-8	-9	-9	-10	-11
Two Outlets (Table 12)	+3	+3	+3	+3	+3	+3
Lp, Discharge Sound at Receiver Location (NC=32)	47	43	28	14	8	21

* Space Effect: V = 5000 ft.³, r = 5 ft.

Table 17: Discharge Sound Path resultant Sound Pressure Levels due to terminal unit for Example 3.

Total Overall Sound

Total Sound = Radiated + Discharge + Air Outlet

The paths are totaled in each octave band using logarithmic addition. Figure 6 may be used as an approximation to save time and simplify this calculation.

Calculation:

$$\text{Total } L_p(\text{octave band}) = 10 \log_{10} \left[10^{\left(\frac{\text{Rad.}}{10}\right)} + 10^{\left(\frac{\text{Disch.}}{10}\right)} + 10^{\left(\frac{\text{Outlet}}{10}\right)} \right]$$

Octave Band	Rad.	Disch.	Outlet	Total
2	50	47	-	52
3	41	43	-	45
4	33	28	29	35
5	21	14	26	27
6	11	8	20	21
7	2	21	-	21

Plot sound pressure levels on NC curve chart. (Figure 1).

Result: Overall Room NC Level = 35.

Acoustic Design and Installation Considerations

To help ensure an acceptable NC Level in the occupied space, engineers can minimize the sound contribution of air terminals by taking into account several design considerations and by using the following guidelines for good design practice.

1. Design systems to operate at low (minimum) supply static pressure at the primary air inlet. This will reduce the generated sound level, provide more energy efficient operation and allow the central fan to be downsized. Excessive static pressure generates noise.
2. Use metal ducts before the inlet. Flexible duct allows significantly greater breakout noise and should be avoided wherever possible. Flexible duct can also generate sound if bends or sagging are present.
3. Select terminals to operate toward the middle area of their operating range. Larger inlets reduce velocity and hence noise. For fan powered terminals, lower fan speeds produce lower sound levels. Sound emissions will be lower when fan speed controllers are used to reduce fan rpm rather than using mechanical dampers to restrict airflow.
4. Whenever possible, locate terminals above non-critical areas that are less sensitive to noise such as corridors,

copy rooms or storage/file rooms. This will isolate critical areas from potential radiated noise.

5. Locate terminals in the largest ceiling plenum space available in order to maximize radiated noise reduction. Install terminals at highest practical point above ceiling in order to optimize radiated sound dissipation.
6. Avoid locating terminals near return air openings or light fixtures. This allows a direct path for radiated sound to enter the space without the benefit of ceiling attenuation.
7. Locate terminals to allow the use of lined discharge ductwork to help attenuate discharge sound.
8. To avoid possible aerodynamic noise, keep airflow velocities below 1000 fpm (5 m/s) in branch ducts and below 800 fpm (4 m/s) in run-outs to air outlet devices.
9. Consider the use of a larger number of smaller air outlets to minimize outlet generated sound. Insulated flexible duct on diffuser run-outs provides excellent attenuation performance.
10. The use of ceilings with a high sound transmission loss classification will help reduce radiated sound.

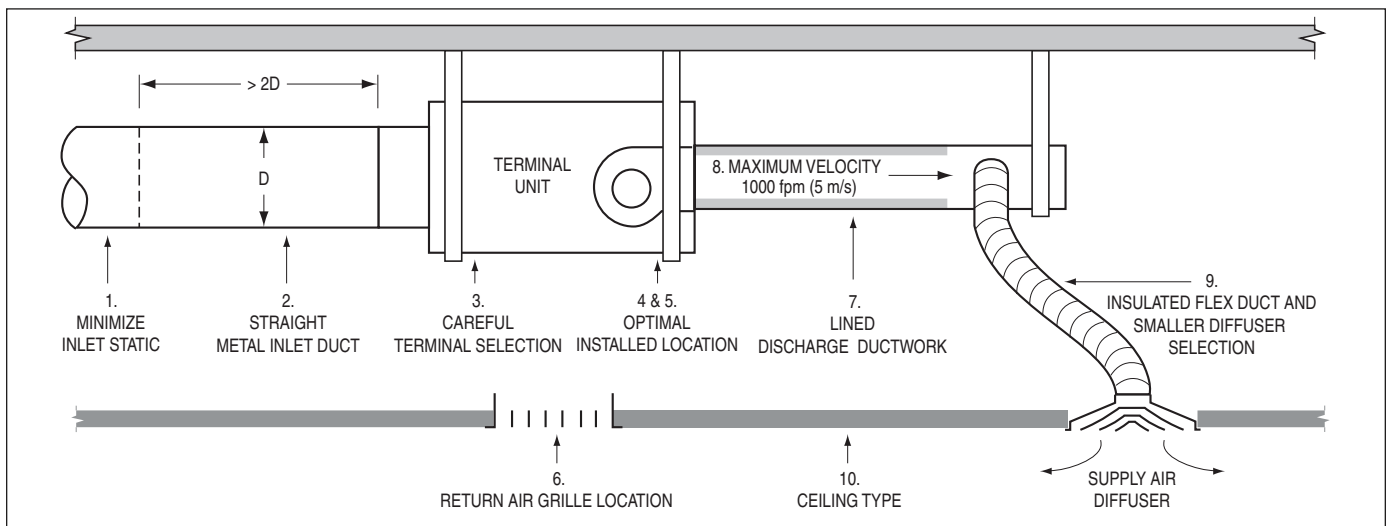

Figure 9: Guidelines for VAV and Fan Powered Terminal Unit Installation for Optimal Acoustic Performance.

Performance Data Explanation

Sound Power Levels vs. NC Levels

Sound Performance for terminal units is provided in two manners: Sound Power levels and NC levels.

The laboratory obtained discharge and radiated sound power levels in octave bands 2 through 7 (125 through 4000 Hz) center frequency for each unit at various flows and inlet static pressures is presented. This data is derived in accordance with ASHRAE 130 and AHRI Standard 880. This data is raw with no attenuation deductions and includes AHRI Certification standard rating points.

Nailor also provides an NC Level table as an application aid in terminal unit selection, which includes attenuation allowances as explained below. The suggested attenuation allowances are not representative of specific job site conditions. It is recommended that the sound power level data be used and a detailed NC calculation be performed using the procedures outlined in AHRI Standard 885, Appendix E for accurate space sound levels.

NC Levels

Tabulated NC Levels are based on attenuation values as outlined in AHRI Standard 885 "Procedure for Estimating Occupied Space Sound Levels in the Application of Air Terminals and Air Outlets". AHRI Standard 885, Appendix E provides typical sound attenuation values for air terminal discharge sound and air terminal radiated sound.

As stated in AHRI Standard 885, Appendix E, "These values can be used as a quick method of estimating space level when a detailed evaluation is not available. The attenuation values are required for use by manufactures to catalog application sound levels. In product catalogs, the end user environments are not known and the following factors are provided as typical attenuation values. Use of these values will allow better comparison between manufactures and give the end user a value which will be expected to be applicable for many types of space."

Radiated Sound

Table E1 of Appendix E provides radiated sound attenuation values for three types of ceiling: Type 1 – Glass Fiber; Type 2 – Mineral Fiber; Type 3 – Solid Gypsum Board.

Since Mineral Fiber tile ceilings are the most common construction used in commercial buildings, these values have been used to tabulate Radiated NC levels.

The following table provides the calculation method for the radiated sound total attenuation values based on AHRI Standard 885.

	Octave Band					
	2	3	4	5	6	7
Environmental Effect	2	1	0	0	0	0
Ceiling/Space Effect	16	18	20	26	31	36
Total Attenuation Deduction	18	19	20	26	31	36

The ceiling/space effect assumes the following conditions:

1. 5/8" (16) tile, 20 lb/ft³ (320 kg/m³) density.
2. The plenum is at least 3 feet (914) deep.
3. The plenum space is either wide [over 30 feet (9 m)] or lined with insulation.
4. The ceiling has no significant penetration directly under the unit.

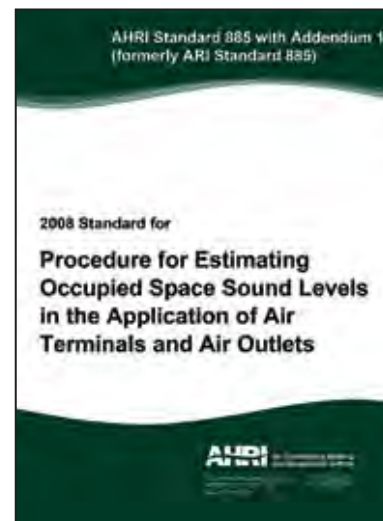

Performance Data Explanation (continued)

Discharge Sound

Table E1 of Appendix E provides typical discharge sound attenuation values for three sizes of terminal unit.

1. Small box: Less than 300 cfm (142 l/s)
[Discharge Duct 8" x 8" (203 x 203)].
2. Medium box: 300 – 700 cfm (142 - 330 l/s)
[Discharge Duct 12" x 12" (305 x 305)].
3. Large box: Greater than 700 cfm (330 l/s)
[Discharge Duct 15" x 15" (381 x 381)].

These attenuation values have been used to tabulate Discharge NC levels applied against the terminal airflow volume and not terminal unit size.

The following tables provide the calculation method for the discharge sound total attenuation values based on AHRI Standard 885.

Small Box <300 cfm	Octave Band					
	2	3	4	5	6	7
Environmental Effect	2	1	0	0	0	0
5 ft. (1.5 m) 1" (25) Duct Lining	2	6	12	25	29	18
Branch Power Division (1 outlet)	0	0	0	0	0	0
5 ft. (1.5 m), 8 in. dia. (203) Flex Duct	5	10	18	19	21	12
End Reflection	10	5	2	1	0	0
Space Effect	5	6	7	8	9	10
Total Attenuation Deduction	24	28	39	53	59	40

Medium Box 300 – 700 cfm	Octave Band					
	2	3	4	5	6	7
Environmental Effect	2	1	0	0	0	0
5 ft. (1.5 m) 1" (25) Duct Lining	2	4	10	20	20	14
Branch Power Division (2 outlets)	3	3	3	3	3	3
5 ft. (1.5 m), 8 in. dia. (203) Flex Duct	5	10	18	19	21	12
End Reflection	10	5	2	1	0	0
Space Effect	5	6	7	8	9	10
Total Attenuation Deduction	27	29	40	51	53	39

Large Box >700 cfm	Octave Band					
	2	3	4	5	6	7
Environmental Effect	2	1	0	0	0	0
5 ft. (1.5 m) 1" (25) Duct Lining	2	3	9	18	17	12
Branch Power Division (3 outlets)	5	5	5	5	5	5
5 ft. (1.5 m), 8 in. dia. (203) Flex Duct	5	10	18	19	21	12
End Reflection	10	5	2	1	0	0
Space Effect	5	6	7	8	9	10
Total Attenuation Deduction	29	30	41	51	52	39

1. Flexible duct is non-metallic with 1" (25) insulation.
2. Space effect (room size and receiver location) 2500 ft.³ (69 m³) and 5 ft. (1.5 m) distance from source.

For a complete explanation of the attenuation factors and the procedures for calculating room NC levels, please refer to Estimating Sound Levels of this section and AHRI Standard 885.

Duct End Reflection Corrections

Duct end reflection occurs at the termination of a duct where there is a large change in cross sectional area, and a significant amount of low frequency sound is reflected back into the duct. New AHRI Standard 880 Performance Rating of Air Terminals regulations require manufactures to catalog discharge sound power levels with duct end reflection corrections. The published discharge sound power levels and NC levels are now higher than before as a result. However, this does not mean the terminal unit got louder, the rating process changed.

Note that the catalog discharge NC Levels will also increase in most cases. This does not mean that the actual room noise levels will be affected since the actual terminal unit sound output has not changed. Field measurements are not affected by these new calculation procedures. However, HVAC designers may find that a certain terminal unit model size at a certain airflow may no longer meet their room NC specification based on the new duct end reflection correction values. Remember that the terminal unit is not actually any louder than before, the same noise level will be heard or measured in the field.

Useful Formulas and Definitions

Airflow

- Q = V x A
- Q = Airflow Rate, cfm (l/s)
- V = Velocity, fpm (m/s)
- A = Area, ft² (m²)

Pressure

- | <i>Imperial Units</i> | <i>Metric Units</i> |
|--|--|
| VP = $\left(\frac{V \text{ (fpm)}}{4005}\right)^2$
(" w.g.) | VP (Pa) = $\left(\frac{V \text{ (m/s)}}{1.3}\right)^2$ |
| VP = Velocity Pressure | |
| TP = SP + VP | |
| TP = Total Pressure, " w.g. (Pa) | |
| SP = Static Pressure, " w.g. (Pa) | |

Heat Transfer

- | <i>Imperial Units</i> | <i>Metric Units</i> |
|------------------------------|--------------------------|
| H = 1.085 x cfm x Δt (°F) | H = 1.23 x l/s x Δt (°C) |
| H = Heat Transfer, Btu's/hr. | H = Heat Transfer, watts |
| Btu = British Thermal Unit | |
| Δt = Temp. Differential | |

Water Coils

- | <i>Imperial Units</i> | <i>Metric Units</i> |
|--|---|
| Δt(°F) = $927 \times \frac{\text{MBH}}{\text{cfm}}$ | Δt (°C) = $829 \times \frac{\text{kW}}{\text{l/s}}$ |
| Δt = Air Temperature Rise | |
| MBH = 1000's of Btu's/hr. | |
| Δt(°F) = $2.04 \times \frac{\text{MBH}}{\text{GPM}}$ | Δt (°C) = $0.244 \times \frac{\text{kW}}{\text{l/s}}$ |
| Δt = Water Temperature Drop | |
| GPM = Water Flow, gallons per minute | |
| l/s = Liters per second | |

Electric Coils

- Δt(°F) = $\frac{\text{kW} \times 3160}{\text{cfm}}$
- kW = $\frac{\text{cfm} \times \Delta t}{3160}$
- Δt = Air Temperature Rise
- kW = Kilowatts

Power DC Circuits

- hp = $\frac{E \times I \times \text{Eff.}}{746}$
- W = E x I
- Eff. = $\frac{746 \times \text{bhp}}{W}$

Power AC Circuits (Single Phase)

- PF = $\frac{W}{E \times I}$
- I = $\frac{746 \times \text{hp}}{E \times \text{Eff.} \times \text{PF}}$
- Eff. = $\frac{746 \times \text{hp}}{E \times I \times \text{PF}}$
- kW = $\frac{E \times I \times \text{PF} \times \text{Eff.}}{1000}$
- hp = $\frac{E \times I \times \text{PF} \times \text{Eff.}}{746}$
- kVA = $\frac{I \times E}{1000}$

Power AC Circuits (Three Phase)

- PF = $\frac{W}{E \times I \times 1.732}$
- I = $\frac{746 \times \text{hp}}{1.732 \times E \times \text{PF} \times \text{Eff.}}$
- Eff. = $\frac{746 \times \text{hp}}{E \times I \times \text{PF} \times 1.732}$
- kW = $\frac{E \times I \times \text{PF} \times 1.732}{1000}$
- hp = $\frac{E \times I \times 1.732 \times \text{PF} \times \text{Eff.}}{746}$
- kVA = $\frac{1.732 \times I \times E}{1000}$
- PF = Power Factor
- W = Watts
- E = Volts
- I = Amperes
- hp = Horsepower
- Eff. = Efficiency

Imperial/Metric Guide Conversion Factors

Quantity	Imperial Unit	Metric Unit		From Imperial To Metric Multiply By:	From Metric To Imperial Multiply By:
Area	square foot	square meter	(m ²)	0.0929	10.764
	square inch	square millimeter	(mm ²)	645.16	0.00155
Density	pounds per cubic foot	kilograms per cubic meter	(kg/M ³)	16.018	0.0624
Energy	British thermal unit (BTU)	joule	(J)	1055.056	0.000948
	kilowatt hour	megajoule	(MJ)	3.6	0.2778
	watts per second	joule	(J)	1.0	1.0
	horsepower hour	megajoule	(MJ)	2.6845	.3725
Force	ounce force	newton	(N)	.278	3.597
	pound force	newton	(N)	4.4482	0.2248
	kilogram force	newton	(N)	9.8067	.102
Heat	BTU per hour	watt	(W)	.2931	3.412
	BTU per pound	joules per kilogram	(J/kg)	2326.0	.00043
Length	inch	millimeter	(mm)	25.4	.0394
	foot	millimeter	(mm)	304.8	.00328
	foot	meter	(m)	.3048	3.2808
	yard	meter	(m)	.9144	1.0936
Mass (weight)	ounce (avoirdupois)	gram	(g)	28.350	.0353
	pound (avoirdupois)	kilogram	(kg)	.4536	2.2046
Power	horsepower	kilowatt	(kW)	.7457	1.341
	horsepower (boiler)	kilowatt	(kW)	9.8095	.1019
	foot pound - force per minute	watt	(W)	.0226	44.254
	ton of refrigeration	kilowatt	(kW)	3.517	.2843
Pressure	inch of water column	kilopascal	(kPa)	.2486	4.0219
	foot of water column	kilopascal	(kPa)	2.9837	.3352
	inch of mercury column	kilopascal	(kPa)	3.3741	.2964
	ounces per square inch	kilopascal	(kPa)	.4309	2.3206
	pounds per square inch	kilopascal	(kPa)	6.8948	.145
Temperature	Fahrenheit	Celsius	(°C)	5/9(°F-32)	(9/5°C)+32
Torque	ounce - force inch	millinewton-meter	(mN.m)	7.0616	.1416
	pound - force inch	newton-meter	(N.m)	.1130	8.8495
	pound - force foot	newton-meter	(N.m)	1.3558	.7376
Velocity	feet per second	meters per second	(m/s)	.3048	3.2808
	feet per minute	meters per second	(m/s)	.00508	196.85
	miles per hour	meters per second	(m/s)	.44704	2.2369
Volume (capacity)	cubic foot	liter	(l)	28.3168	.03531
	cubic inch	cubic centimeter	(cm ³)	16.3871	.06102
	cubic yard	cubic meter	(m ³)	.7646	1.308
	gallon (U.S.)	liter	(l)	3.785	.2642
	gallon (imperial)	liter	(l)	4.546	.212
Volume (flow)	cubic feet per minute (cfm)	liters per second	(l/s)	.4719	2.119
	cubic feet per minute (cfm)	cubic meters per second	(m ³ /s)	.0004719	2119
	cubic feet per hour (cfh)	milliliters per second	(ml/s)	7.8658	.127133
	gallons per minute (U.S.)	liters per second	(l/s)	.06309	15.85
	gallons per minute (imperial)	liters per second	(l/s)	0.07577	13.198

Pressure Measurement

Concepts of Pressure. Pressure is force per unit area. This may also be defined as energy per unit volume of fluid. There are three categories of pressure — Total Pressure, Static Pressure and Velocity Pressure. They are all associated with air handling. Unit of pressure is expressed in inches of water, designated **in. w.g.**

Static Pressure is the normal force per unit area at a small hole in the wall of a duct or other boundaries. It is a function of air density and degree of compression. It may be thought of as the pressure in a tire or in a balloon which extends in all directions.

Velocity Pressure is the force per unit area capable of causing an equivalent velocity in moving air. Velocity pressure is a function of air density and velocity. At standard air density, the relationship between velocity pressure and velocity is expressed in the following formula:

$$P_v = \left(\frac{V}{4005} \right)^2 \text{ or } V = 4005 \sqrt{P_v}$$

Where: V = Air Velocity (FPM)
 P_v = Velocity Pressure (in. w.g.)

Total Pressure, as its name implies, is the sum of static pressure and velocity pressure.

The Pitot Static Tube is an instrument used to measure pressure and velocities as illustrated below. It is constructed of two tubes. The inner, or impact tube, senses the total pressure as the impact opening faces upstream. The outer tube senses only the static pressure, which communicates with the airstream through small holes in its wall.

The U-Tube Manometer connects both parts of the Pitot Static Tube. The manometer functions as a subtracting device to give a reading of velocity pressure.

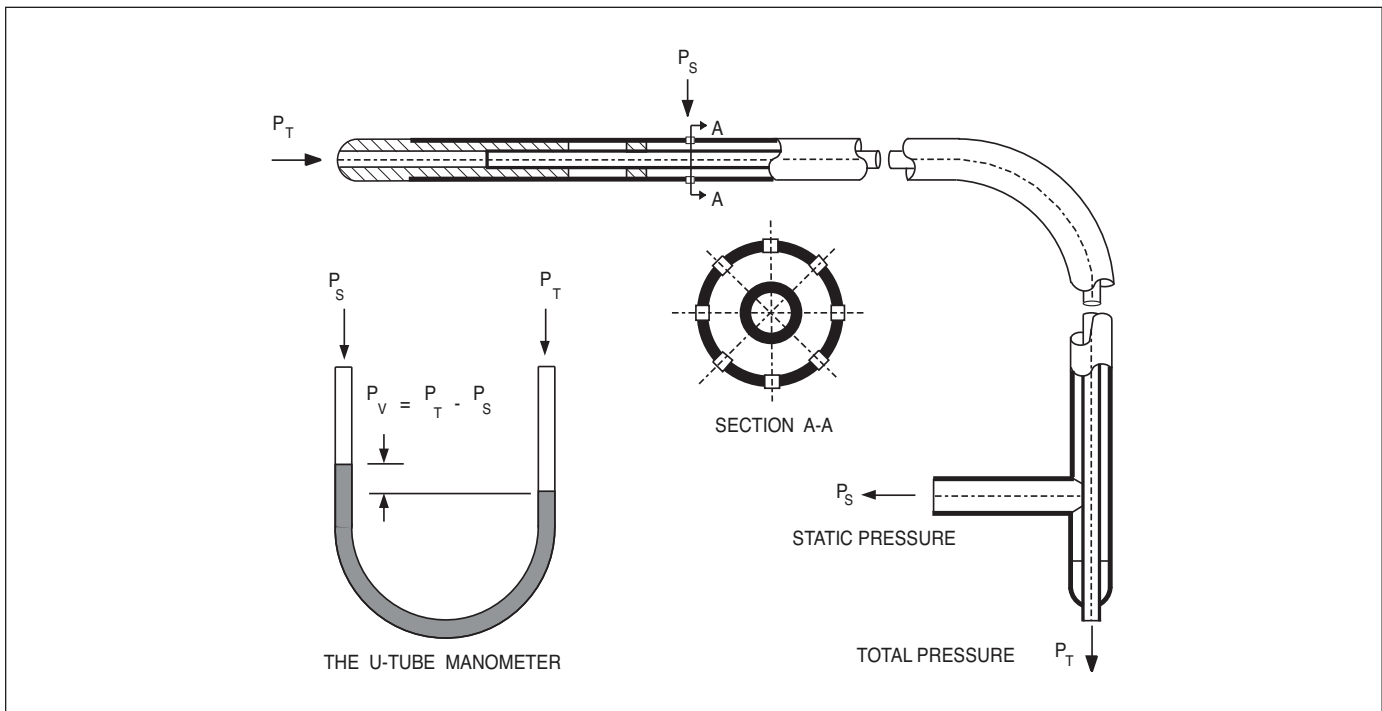

MODEL	DESCRIPTION	PAGE NO.
3001	Single Duct, No Heat.....	A6
3001Q	Single Duct, Quiet with Dissipative Silencer, No Heat.....	A22
30HQ	Single Duct, Hospital Grade, Quiet with Dissipative Silencer, No Heat.....	A32
30HQE	Single Duct, Hospital Grade, Quiet with Dissipative Silencer, Electric Reheat	A32
30HQW	Single Duct, Hospital Grade, Quiet with Dissipative Silencer, Hot Water Reheat	A32
30HQX	Single Duct, Exhaust, Hospital Grade, Quiet with Dissipative Silencer.....	A68
30RE	Single Duct with Electric Reheat	A6
30REQ	Single Duct, Quiet with Dissipative Silencer, Electric Reheat.....	A22
30RW	Single Duct with Hot Water Reheat	A6
30RWQ	Single Duct, Quiet with Dissipative Silencer, Hot Water Reheat	A22
30X	Single Duct, Exhaust.....	A54
3210	Dual Duct, No Mixing	B4
3230	Dual Duct with Compact Mixing Attenuator	B11
3240	Dual Duct BlendMaster™ with High Efficiency Mixing Attenuator	B18
33SZ	Fan Powered, Series Flow, Chilled Water for DOAS, No Heat	C14
33SZE	Fan Powered, Series Flow, Chilled Water for DOAS, Electric Heat.....	C14
33SZW	Fan Powered, Series Flow, Chilled Water for DOAS, Hot Water Heat	C14
3400	Bypass, No Heat	E3
34RE	Bypass with Electric Reheat.....	E3
34RW	Bypass with Hot Water Reheat	E3
35N	Fan Powered, Parallel Flow, No Heat.....	C105
35NE	Fan Powered, Parallel Flow with Electric Heat	C105
35NW	Fan Powered, Parallel Flow with Hot Water Heat.....	C105
35S	Fan Powered, Series Flow, No Heat.....	C35
35SE	Fan Powered, Series Flow with Electric Heat.....	C35
35SW	Fan Powered, Series Flow with Hot Water Heat	C35
35SST	Fan Powered, Series Flow, "Stealth™", No Heat	C49
35SEST	Fan Powered, Series Flow, "Stealth™" with Electric Heat	C49
35SWST	Fan Powered, Series Flow, "Stealth™" with Hot Water Heat.....	C49
35S-OAI	Fan Powered, Series Flow, Outside Air Inlet, No Heat.....	C62
35SE-OAI	Fan Powered, Series Flow, Outside Air Inlet with Electric Heat.....	C62
35SW-OAI	Fan Powered, Series Flow, Outside Air Inlet with Hot Water Heat	C62
35SST-OAI	Fan Powered, Series Flow, "Stealth™", Outside Air Inlet, No Heat	C62
35SEST-OAI	Fan Powered, Series Flow, "Stealth™", Outside Air Inlet, Electric Heat.....	C62
35SWST-OAI	Fan Powered, Series Flow, "Stealth™", Outside Air Inlet, Hot Water Heat	C62
35S-CVP	Fan Powered, Series Flow, Pressurization with No Heat	C69
35SE-CVP	Fan Powered, Series Flow, Pressurization with Electric Heat.....	C69
35SW-CVP	Fan Powered, Series Flow, Pressurization with Hot Water Heat	C69
36FMSD	Flow Measuring Station with Balancing Damper	D14
36VR	Internal Retrofit.....	D3
36VRR	Round Retrofit	D5
36VRS	Square and Rectangular Retrofit.....	D10
37N	Fan Powered, Parallel Flow, Low Profile, No Heat.....	C119
37NE	Fan Powered, Parallel Flow, Low Profile with Electric Heat	C119
37NW	Fan Powered, Parallel Flow, Low Profile with Hot Water Heat.....	C119
37S	Fan Powered, Series Flow, Low Profile, No Heat.....	C80
37SE	Fan Powered, Series Flow, Low Profile with Electric Heat.....	C80
37SW	Fan Powered, Series Flow, Low Profile with Hot Water Heat	C80
37SST	Fan Powered, Series Flow, "Stealth™", Low Profile, No Heat	C91
37SEST	Fan Powered, Series Flow, "Stealth™", Low Profile, Electric Heat.....	C91
37SWST	Fan Powered, Series Flow, "Stealth™", Low Profile, Hot Water Heat	C91



"Complete Air Control and Distribution Solutions"

International Group Locations:

United States and International Headquarters, Sales, Manufacturing, Research and Development and Test Laboratory:

Nailor Industries of Texas Inc.
4714 Winfield Road,
Houston, Texas 77039
U.S.A.
Tel: 281-590-1172
Fax: 281-590-3086
info@nailor.com
www.nailor.com

Canadian Headquarters, Sales and Manufacturing:

Nailor Industries Inc.
98 Toryork Drive,
Toronto, Ontario M9L 1X6
Canada
Tel: 416-744-3300
Fax: 416-744-3360

European Sales and Marketing Center, Manufacturing:

(also responsible for exports to the Middle East, Asia and Australia):

Advanced Air (UK) Ltd.
Burrell Way,
Thetford, Norfolk
IP24 3QU
England
Tel: (0)1842 765657
Fax: (0)1842 762032
info@advancedair.co.uk
www.advancedair.co.uk

Regional Sales and Manufacturing Facilities:

Nailor Industries Inc. (Western U.S.A.)
3730 Civic Center Drive
Las Vegas, NV 89030
U.S.A.
Tel: 702-648-5400
Fax: 702-638-0400

Nailor Industries (Western) Inc.
Unit F, 4427-72nd Avenue S.E.
Calgary, Alberta T2C 2G5
Canada
Tel: 403-279-8619
Fax: 403-279-5035

EZVAV DIGITAL CONTROLS



EZ to order. EZ to install. EZ to setup, commission and balance.



The new EZvav Digital Controls by Nailor bring simplicity to the Variable Air Volume (VAV) terminal unit market. Designed for both stand-alone applications and for integration with BACnet building automation systems, EZvav are precise P+I pressure independent VAV controllers that are pre-configured for standard control sequences that cover the vast majority of terminal unit applications.

All terminal units with electric or hot water heating coils are supplied as standard with a DAT Discharge Air Temperature control sensor that can limit the discharge air temperature to a maximum of 15 °F above room set point, helping compliance with ASHRAE Standard 62.1 and 55.

Field commissioning and balancing can all be performed using the standard digital display room temperature sensor, which has an intuitive menu driven setup. No laptop, expansion modules, communication interface or software is required.

FEATURES & BENEFITS:

- Integrated controller/actuator/transducer
- Factory mounted and wired for new building applications
- Ideal for retrofitting and upgrading pneumatic and analog controls to a digital solution
- Room temperature sensor (thermostat) options include Digital Display, Occupancy Sensor and compact Rotary Dial models
- Remote fan volume adjustment from 0 – 100% for EPIC ECM fan powered terminals
- Simple menu driven setup
- BACnet BMS network integration ready

Application Control Sequences Include:

- Single Duct VAV or CAV Cooling only and Heat/Cool Changeover
- Single Duct VAV Cooling with reheat
- Dual Duct Variable Volume or Constant Volume control

- Series Fan Powered Constant Volume with/without supplementary heat
- Parallel Fan Powered Variable Volume with/without supplementary heat

Heating Control Options:

Binary (up to 3 stages of electric heat), Modulating (0 – 10 Vdc analog) or Floating heat control.

Native BACnet

All models are BACnet Applications Specific Controllers that are ready to connect to a BACnet MS/TP network. Device instance, MAC address and baud rate are set from an STE-8001W36 without special software.

EZ to order

Nailor Representatives' Automated Pricing Program (RAPP) features EZ quick select options for control sequences and room temperature sensor options based on terminal unit type and application requirement.

EZ to install

For field retrofit applications, the EZvav controller is mounted within a terminal unit controls enclosure and directly coupled to the damper shaft. The flow sensor, power supply, heat and temperature sensors are then connected. The EZvav controller automatically detects them without programming or software tools.

EZ to setup, commission and balance

All options can be set by using an STE-8001W36 sensor as a technician's service tool or installed as a permanent room sensor. The EZvav Controller can be stocked by representatives to provide a simple digital solution to their customers that wish to upgrade their pneumatic or analog inventory to a new digital solution, perfect for retrofit applications!

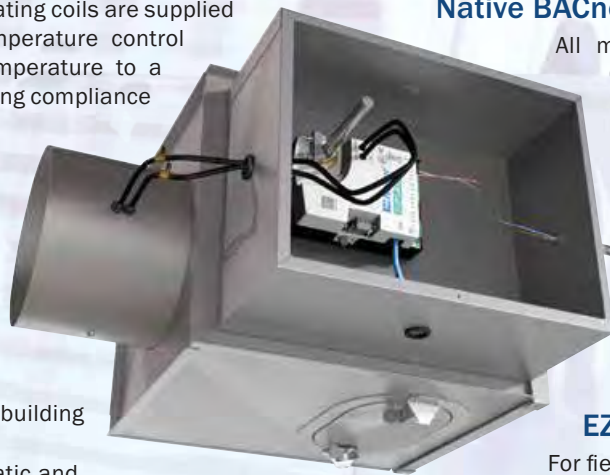

SHHH... Keep it quiet!

A Phrase you will not hear when using
Nailor's Quiet Type 3000Q Series Terminals...

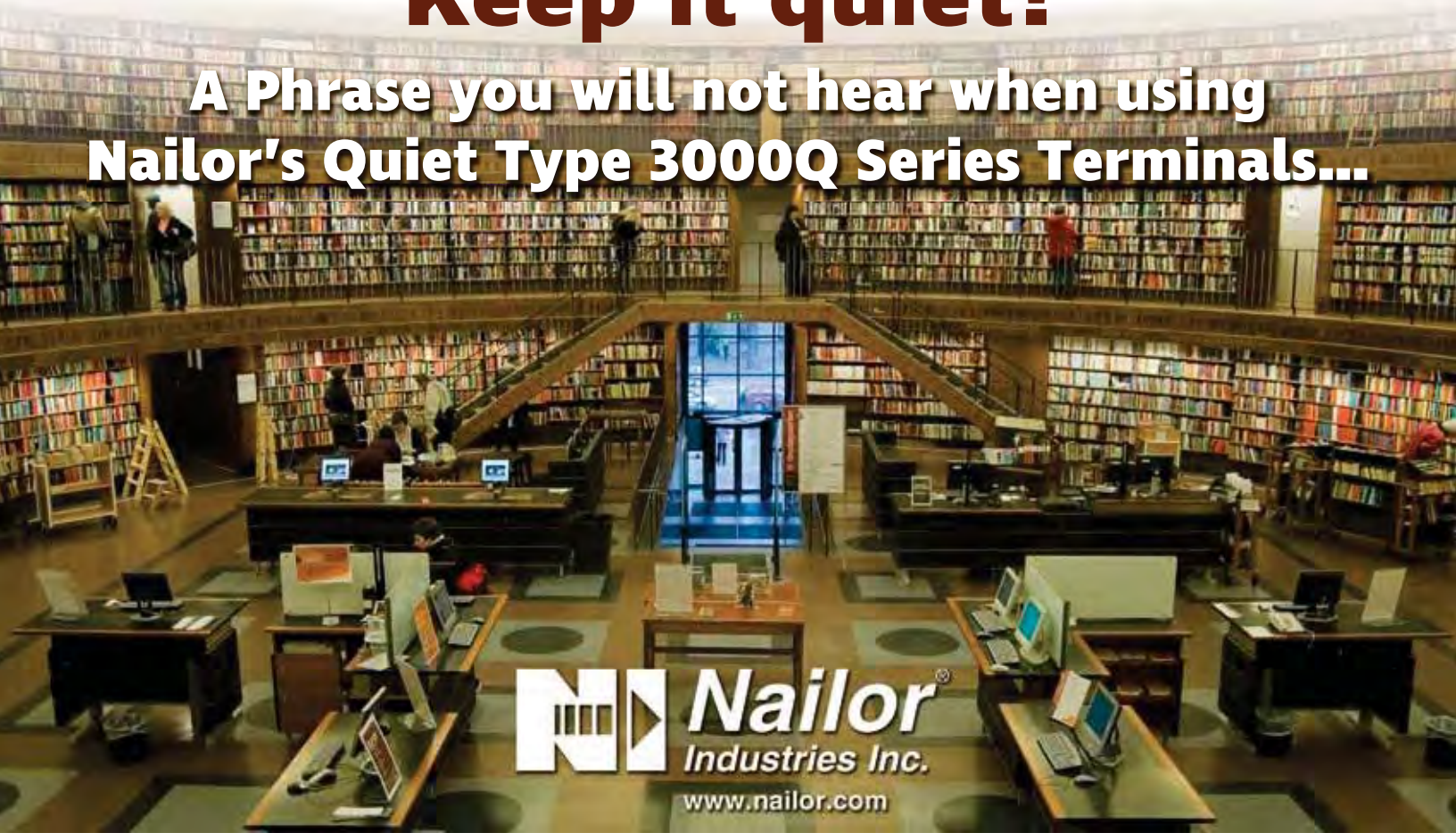

 **Nailor**[®]
Industries Inc.
www.nailor.com

Nailor's 3000Q Series deliver exceptionally quiet performance. Using a purpose designed integral dissipative silencer to minimize pressure loss, reduce self-generated sound and maximize acoustical attenuation the 3000Q Series is ideal for use in: Libraries, Studios, Performance Halls, Conference Rooms and Classrooms to name a few!

Features:

- Nailor's unique inclined opposed blade damper for premium performance and control
- Compact design with performance of close coupled device
- 11 sizes ranging from 0 – 8330 cfm (3931 l/s)
- Choice of terminal liners with 3 acoustical liner types
- Available with hot water and electric reheat
- Seismic certification
- Oversized casing option

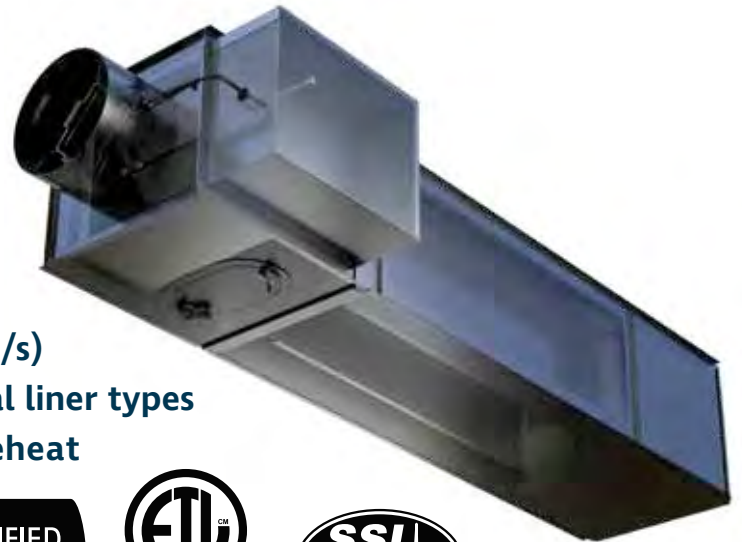

PRODUCT SPOTLIGHT

FAN POWERED CHILLED WATER TERMINAL UNIT 33SZ SERIES AT A GLANCE

Nailor offers a full range of commercial quality air distribution products. Experience has built a solid reputation for design and engineering excellence, performance, flexibility and creativity. Whether the project uses a factory ready product or requires customization, Nailor is capable and ready to provide a complete solution.

We are pleased to announce the addition of the model series 33SZ, Fan Powered Chilled Water Terminal to our already efficient and flexible terminal unit lineup. The 33SZ is a fan powered terminal that includes a cooling induction coil to use in conjunction with a DOAS (dedicated outdoor air system) and is useful in a variety of commercial applications, such as office spaces, classrooms, critical environments, laboratories, etc.

FEATURES

The 33SZ Series is available in both low profile and standard unit heights. Standard EPIC ECM motors provide the quiet, wide turn down ratios and energy efficiency pioneered by Nailor. Similar in overall construction to the standard fan terminal units, features including electric heat, hot water reheat, 2, 4 and 6 row induction chilled water coils and multiple liner options.

MATERIAL

Each 33SZ is constructed with heavy gauge galvanized steel and the seemingly small details, like integral drip pans and numerous coil configurations, provide for a reliable, long lasting and flexible product.

- 20 ga. (1.0) galvanized casing
- Available IAQ liner offerings
- Ultra-energy efficient ECM with solid state EPIC volume controller

CONSIDER THE FACTS

FPCWT 33SZ Series terminals are constructed with a draw-thru induction chilled water coil.

Benefits:

The unit can be used in a variety of applications including zone sensible cooling, supplemental heating, or even used together with an AHU to take advantage of economizer model. Depending on application, the 33SZ provides a universal product in a footprint similar to well established fan powered terminals. Additionally, the ducted discharge can service a larger zone than say, a chilled beam product.

Simplicity:

- More versatile than a chilled beam or standard fan powered terminal
- Industry familiar installation and operation
- Effective overhead ventilation control
- Flexibility with reheat and various control schemes

QUICK DESIGN FEATURES

- An ideal cost effective solution for complying with ASHRAE standards 62.1 ventilation and 5.5 thermal comfort requirements
- Ideal for use with a dedicated outdoor air system (DOAS air handler)
- Standard and Low-Profile designs
- Draw-Thru Induction Coil available in 2, 4 or 6 rows for maximum capacity
- Ultra-high efficiency ECM motor with pressure independent "EPIC Fan Technology[®]"
- Airflow capacities* of 300 – 2000 CFM
*Capacities are dictated by cabinet size and available options
- Available with electric or hot water supplementary heat
- Integral condensate drip pan as standard
- Couple with digital controls for most efficient and accurate system operation
- Pressure independent primary supply damper with integrated airflow sensor
- Flexibility of diffuser selection allows for better turn-down, aesthetic, performance and cost options
- Versatility of load diversity for both 33SZ and AHU's, save energy over typical constant volume systems, such as active chilled beam systems

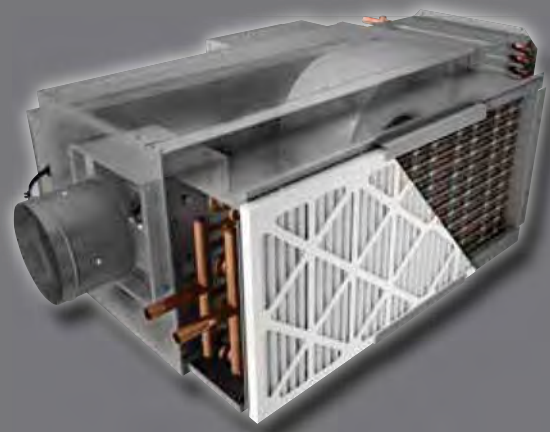



Air Distribution Products:

- Flowline
- Grilles and Registers
- Ceiling Diffusers
- Linear Diffusers
- Plenum Slot Diffusers
- Fire Rated Assemblies
- Hospital/Cleanroom Diffusers



Air Control Products:

- Louvers
- Control & Backdraft Dampers
- Curtain Fire Dampers
- Multi-Blade Fire Dampers
- Smoke Dampers
- Combination Fire/Smoke Dampers
- Ceiling Dampers
- Access Doors



Green Building Products

- Underfloor Air Distribution Systems
- Displacement Ventilation



Electric Duct Heaters:

- Slip-in/Insert Mount
- Flanged Mount
- Round Duct Connection



Fan Coil Units

- Vertical Hi-Rise & Closet
- Horizontal Fan Coil Units
- Vertical Sill Fan Coil Units

WTUCB

Complete Air Control and Distribution Solutions

For the most up to date catalog information go to
www.nailor.com

