

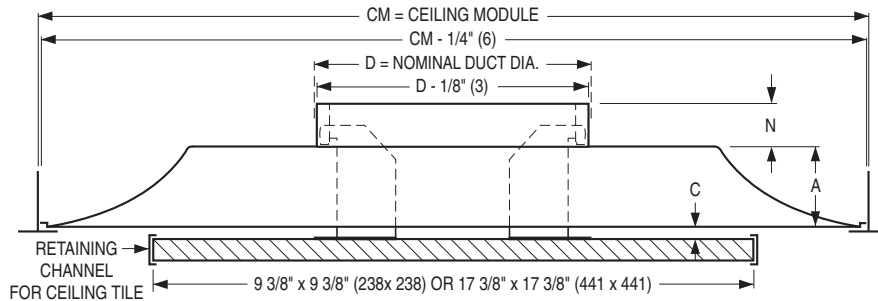

# ARCHITECTURAL CEILING DIFFUSERS

SQUARE PLAQUE • CONCEALED NECK BRACKETRY  
CEILING TILE MOUNTING • STEEL • ROUND NECK  
MODEL: UNI WITH RC OPTION

**TYPE L Lay-in T-Bar**



**Dimensional Data**

Ceiling Module CM		Imperial Units (inches)						Metric Units (mm)					
Imperial Modules	Metric Modules	Duct Size D	N	A	B	C	F	Duct Size D	N	A	B	C	F
12 x 12	300 x 300	4*	3 1/4	1	11	5/8	13	102*	83	25	279	16	330
		5, 6, 7, 8	1 1/4					127, 152, 178, 203	32				
24 x 24	600 x 600	6, 8, 10, 12, 14, 15	1 1/4	2 5/16	22	3/8	24 3/4	152, 203, 254, 305, 356, 381	32	59	559	10	629

\* Supplied with a reducer.

**DESCRIPTION:**

1. Material: Corrosion-resistant steel.
2. The UNI Diffuser has been designed to provide both the unobtrusive appearance for architectural excellence and engineered performance. Unique, concealed neck bracketry design is virtually invisible from a normal viewing position, giving the appearance that the plaque face floats below the backpan. There are no visible corner posts as on competitor's models to detract from the aesthetically clean design.
3. The diffuser delivers a tight 360° radial horizontal pattern allowing high turn down ratios with no dumping. Excellent for VAV systems.
4. Stamped one-piece outer cone eliminates mitered corners. Inner diffuser plate is supplied with a retaining channel for mounting a ceiling tile up to 5/8" (16) thick for a unique custom appearance. Blends harmoniously with architectural ceiling design. The RC retaining channel is shipped separately for field installation of a ceiling tile that has been cut to size. The RC channel is supplied in two pieces with pop rivets for field assembly.
5. A spring clip arrangement permits quick, easy installation and removal of the inner core assembly.
6. Standard finish is AW Appliance White.

**OPTIONS:**

- CF Ceiling tile cut and factory mounted (supplied by others)
- EX External Foil-Back Insulation, installed - R-4.2
- EXB External Foil-Back Insulation, ships loose - R-4.2
- MIB Molded Insulation Blanket - R-6.0 (24 x 24 only)
- EIC Extended Inlet Collar (2.25") with bead
- EQT Earthquake Tabs

**Finish:**

- SP Special. Specify \_\_\_\_\_.

**QB Quadrant Blanks:**

- QB3 3-Way Blow
- QC2 2-Way Corner Blow
- QB2 2-Way Opposite Blow
- QB1 1-Way Blow

Dimensions are in inches (mm). Finline® is a registered trademark of USG Interiors Inc.

**TYPE L Surface Mount**

Hard duct connection recommended.

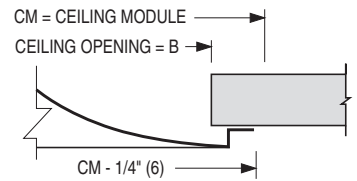

**TYPE L Surface Mount With DFA**

Drywall/Plaster frame. Recommended for flexible duct connection and ceiling access

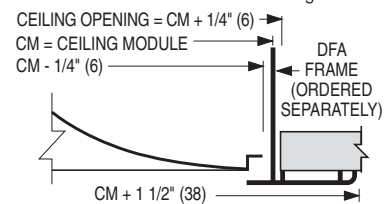

**TYPE S Surface Mount**

CEILING OPENING = CM - 1" (25)

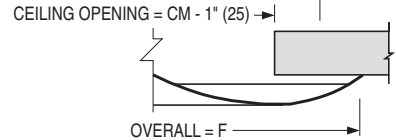

**TYPE F Finline®**

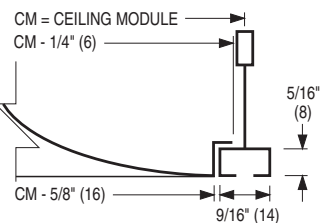

**TYPE M Metal Pan (Snap-in)**

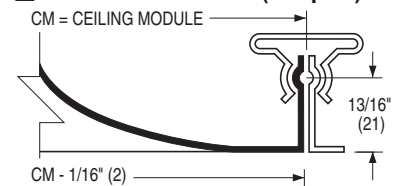

**TYPE SP Spline**

For one directional exposed T-Bar or fully concealed grid. 1 spline on two opposite sides. Steel lift brackets on other.

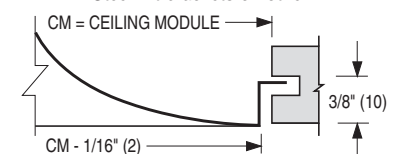

**SCHEDULE TYPE:**

**PROJECT:**

**ENGINEER:**

**CONTRACTOR:**

**DATE**

**B SERIES**

**SUPERSEDES**

**DRAWING NO.**

4 - 20 - 17

UNI

1 - 24 - 17

UNI-3