

GENERAL PRODUCT OVERVIEW

Leading The Industry

Providing products that incorporate the desires and requirements of the industry we serve has traditionally been a primary focus at Nailor.

We listened in-depth to the engineering and contracting community, asked a lot of questions and realized there was not a single line of fan powered terminals available that incorporated all the design features and performance criteria that satisfied their wishes.

After an extensive and intense period of research, design and development, we have produced a line of fan powered terminals that satisfy the vast majority of requirements the HVAC industry demands.

On the next page, you can see at a glance some of the unique universal features that have been incorporated into Nailor fan powered terminals, providing the benefits of high performance operation and many field-friendly features to aid installation.

All Nailor terminals include the following additional features as standard:

- Compatibility with digital, analog electronic and pneumatic controls.
- Fan motors and heaters are energized and dielectric tests are performed on every terminal to ensure correct operation prior to shipment.
- Custom fabricated motor/blower combinations are mounted on special heavy gauge angles and isolated from casing with rubber insulators.
- All motors incorporate an anti-backward rotation design to prevent backward rotation upon start-up.
- Units can be flipped in the field for right or left hand configuration except Model Series 33SZ.

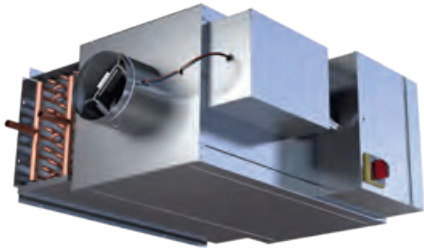

Model Series 33SZ. Basic Unit
Chilled Water, Series Flow, (Constant or Variable Volume)

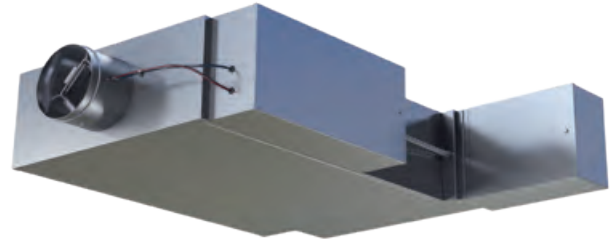

Model Series 37SE, Electric Heat
Series Flow (Constant or Variable Volume)

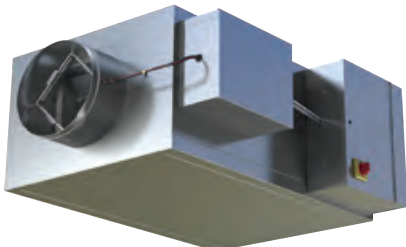

Model Series 35S. Basic Unit
Series Flow (Constant or Variable Volume)

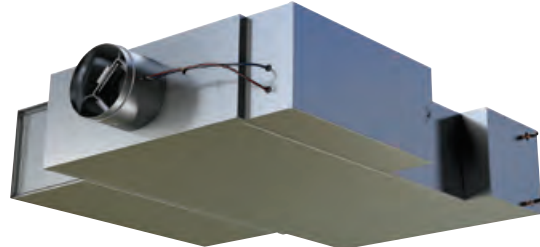

Model Series 37SST Stealth™, Hot Water Heat
Super Quiet, Series Flow (Constant or Variable Volume)

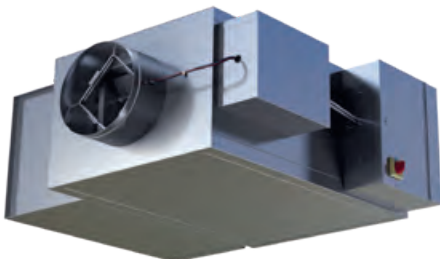

Model Series 35SST Stealth™, Hot Water Heat
Super Quiet, Series Flow (Constant or Variable Volume)

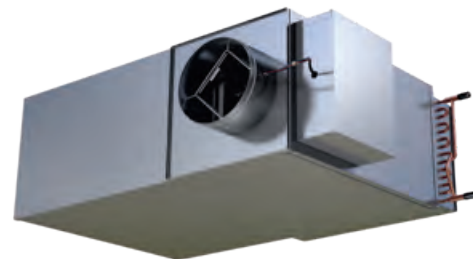

Model Series 35NW, Hot Water Heat
Compact Design, Parallel Flow (Variable Volume)

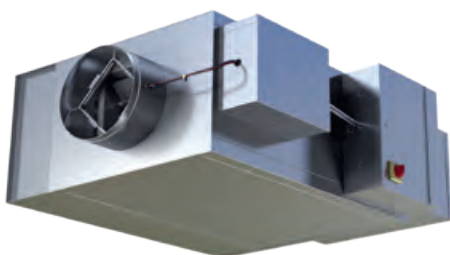

Model Series 35SEXC Stealth™, Electric Heat
Super Quiet, Series Flow (Variable Volume)

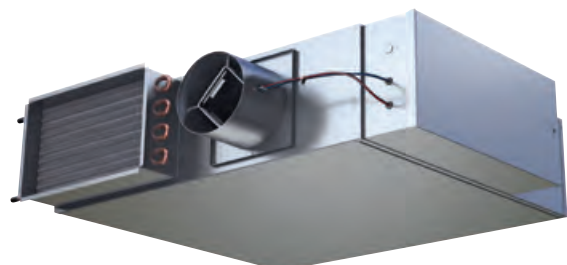

Model Series 37NW, Hot Water Heat
Low Profile Design, Parallel Flow (Variable Volume)

Design Characteristics and Application

Introduction

Fan Powered Terminal Units are an economical means of both cooling and periodically heating the perimeter zones of a building utilizing a single duct control system. In addition to inherent VAV economies, fan terminals utilize the free heat derived from lighting, people and other equipment and induce this warmer plenum air from the building core ceiling plenum space and re-circulate it to rooms calling for heating. If additional heating is required, optional supplementary heating coils may be activated. The need for a central source of warm air is eliminated.

During weekend or night-time operation, the central fans may be turned off. Heat, if required, may be provided by the terminal unit fan itself.

Fan Powered Terminal Units are the most popular design for office buildings because they provide performance benefits by reducing first cost, (such as lower central system fan HP and smaller ductwork), lower operating cost, the recovery of waste heat, and the capacity for improved air circulation and diffuser performance.

Fan terminals are available in two basic configurations; series or parallel flow. Each contains a fan motor assembly and a variable air volume damper to modulate primary air.

In a series unit (Fig. 1), the fan sits in the primary air stream and runs constantly when the zone is occupied. In a parallel unit (Fig. 2), the fan sits outside the primary air stream and runs intermittently.

Although both terminals can provide central fan HP savings, each terminal has different inlet static pressure requirements. Series fan terminals boost both induced air and primary air, so the inlet static pressure only needs to overcome the loss across the damper [less than 0.05" w.g. (12 Pa)] with Nailor terminals. Parallel fan terminals require enough static pressure to overcome the losses across the damper, the downstream ductwork and diffusers [typically 0.25 — 0.5" w.g. (62 — 124 Pa)] with Nailor terminals.

Series Flow Terminals – (Constant Volume)

A series fan powered terminal unit mixes primary air with induced plenum air by using a continuously operating fan during the occupied mode. It provides a constant volume of air to the space regardless of load.

As the cooling load decreases, the zone thermostat throttles the primary air valve. The terminal fan makes up the difference by inducing more return air from the plenum. At low cooling loads, the primary air may close or go to a minimum ventilation setting. If the zone temperature drops still further, the thermostat can energize optional supplemental heat. The sequence reverses when the load is increased.

The series terminal is therefore a constant volume, variable temperature unit. (See Fig. 3).

Series units should only be used with pressure independent controls. Series fans must be adjusted to match the maximum

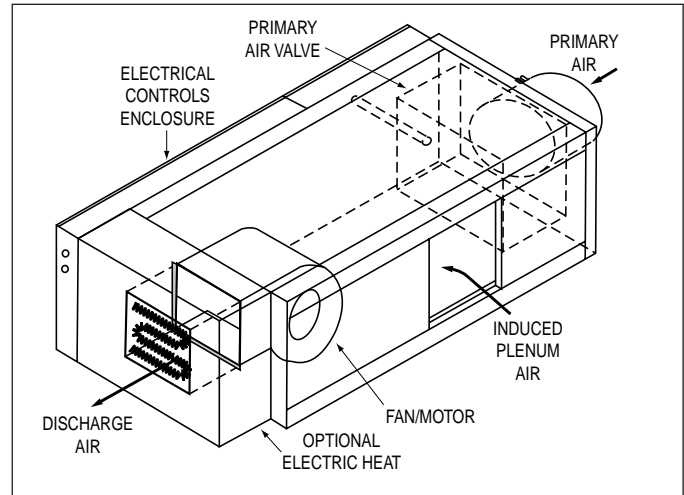

Figure 1. Series Fan Terminal

cooling cfm, to ensure that the primary air does not exceed the fan cfm as this would result in the short-circuiting of primary air directly into the ceiling plenum and waste energy. A pressure independent controller and inlet flow sensor controls the primary air valve to compensate for changes in inlet static pressure and ensures design cfm is maintained.

Parallel Flow Terminals – (Variable Volume)

Also called an intermittent fan terminal unit, a parallel unit modulates primary air in response to cooling demand and energizes the integral fan in sequence to deliver induced air to meet heating demand. The induction fan operating range should slightly overlap the range of the primary air valve. A backdraft damper ahead of the terminal fan restricts conditioned air from escaping into the return air plenum when the fan is off.

During full cooling demand, the thermostat positions the primary air valve for full airflow while the fan is de-energized. As the cooling load decreases, less primary air is delivered to the zone as the thermostat modulates the valve (functioning as a single duct VAV terminal).

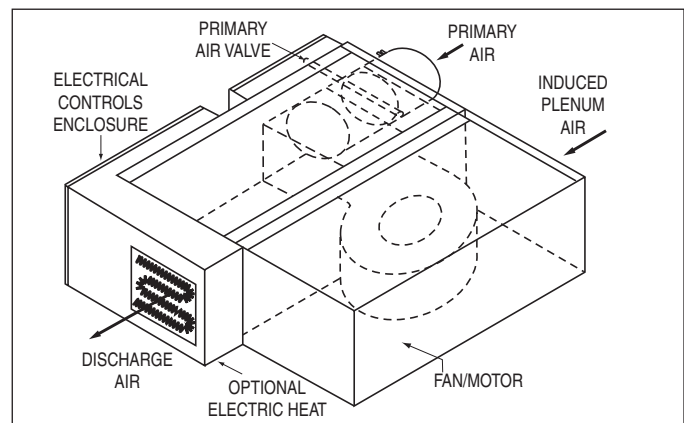

Figure 2. Parallel Fan Terminal

Common Fan Terminal Components

The Diamond Flow multi-point averaging sensor is standard on all Nailor terminal units that are equipped with pressure independent controls.

In addition to the Diamond Flow multi-point averaging sensor and opposed blade damper configuration of the primary air valve that are described in detail on page O11 in this catalog, all Nailor fan powered terminals incorporate the following features and benefits.

Single Speed PSC Induction Motors

All Nailor fan powered terminal units are currently equipped with single speed, direct drive, fractional horsepower, high efficiency, PSC motors as standard. These motors are manufactured to specifications developed by Nailor specifically for the fan powered terminal unit market. Some of the more important features of PSC motors are listed and explained below.

- **No Corona Effect**

Motors not only provide power, but act as transformers and generators. Under certain conditions, this causes the unused speed taps in multiple speed motors to have large potential or static charges present. While these charges are not doing any work, they will create damage to the windings if their potential voltages are greater than the winding insulating quality. This is often the case and lifetimes are shortened. Nailor fan powered terminal units do not suffer from this malady. All motors are single speed.

- **Wide Operating Ranges**

Nailor motors are designed to operate at rotational speeds lower than those of our competitors. This requires special stator wire sizing, special capacitor sizing and special bearings. These items are covered in our specifications. This assures you of high end performance equal to or better than any of our competitors and low end ranges below any of our competitors.

Low end performance is often ignored. Many times, this is because the range is not great enough to allow much difference, or because the low end performance is achieved by artificial means such as manual dampers to lower the airflows. Manual dampers lower airflows, but they increase RPM. Increased RPM puts back all the noise generated in the fan powered terminal unit as if it were still operating at full airflow. This is due to the noise caused by tip speed and vibration within the unit. High RPM, regardless of airflow will generate high noise.

Nailor solves this problem through low RPM for low airflows. Typically, the motors in Nailor fan powered terminal units can rotate as low as 350 RPM at low end, shedding as many as 14 to 20 decibels in the second and third octave bands depending on which unit is being selected. This means real sound level selections, units that can produce NC's of 30 and 35 when applied correctly and wider operating ranges on individual units for greater flexibility in the zone.

- **Permanently Lubricated Motors**

Nailor fan powered terminal units are equipped with permanently lubricated motors. The motors are equipped with oilers, but the oilers are not necessary as long as the units are operated in typical ambient temperature conditions. The specifications call for the oil reservoirs to have at least 50% of the original oil still in the reservoir after 50,000 hours of use under normal conditions.

- **Permanent Split Capacitor Design**

All Nailor fan powered terminal units are supplied with PSC motors as standard. The capacitors are sized to provide ample starting torque, even when turned down to the low minimums allowed on Nailor fan powered terminal units.

- **High Efficiency**

All Nailor PSC motors have the highest efficiency available in the market today. This too, is controlled by the Nailor motor specifications. Higher efficiency means lower operating expenses.

PSC Fan Speed Controllers

Nailor designed its own solid state fan speed controllers. They are designed to operate with the specific motor and blower combinations as used in Nailor fan powered terminal units. They provide smooth and infinite adjustment of motor speed from maximum to the lowest preset low end limits found in the industry.

The speed controllers are largely responsible for the operating ranges of the motors. High quality standards allow very accurate low end stops. This assures Nailor customers of sound levels and performance as cataloged.

The matching of the motors and speed controllers allows Nailor fan powered terminal units lower watt consumption as motor RPM's are reduced. High efficiency is maintained from high end performance to low end performance. Very few of our competitors can make a similar claim.

Low Noise Levels – AHRI Certified

In addition to those items listed above, Nailor holds down noise levels in the occupied space with heavy gauge metal casings, dual density insulation and multiple isolation points between motors and casings. Nailor is as quiet as any and far quieter than most of our competitors when controlling similar airflows on competitive equipment. Check out the sound data in this catalog. Notice there is no fine print covering the conditions under which the data does not apply. Notice that the minimum static requirement on series fan powered terminal units is 0.05" w.g. (12 Pa). Then notice the correspondingly low inlet static pressures on the parallel units. Notice that Nailor sound data is AHRI certified and independently certified by Energistics Laboratory, Houston. Compare that to the competition.

ECM/EPIC FAN TECHNOLOGY®

- Significant energy savings (67% typical compared to PSC motors)
- Unique factory pre-set air volume capability (+/- 5%)
- Pressure independent fan operation
- LED for visual indication of air volume
- Field adjustable fan air volume controller
- Remote fan air volume adjustment capability from BAS
- Larger turn down ratios mean more flexibility for tenant changes

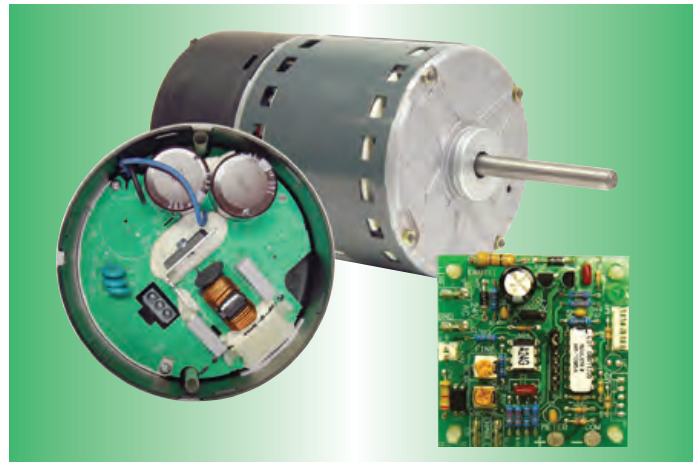

Since 1985, equipment manufacturers have used ECM's in residential air conditioners and furnaces. These motors have made it possible to achieve SEER ratings of 12 and higher. Nailor first introduced the ECM to the commercial HVAC market (ASHRAE Journal, April 1997) as an option for use in series fan powered terminal unit applications.

WHAT IS AN ECM?

The ECM (Electronically Commutated Motor) is an ultra high efficiency programmable brushless DC motor utilizing a permanent magnet motor and a built-in AC/DC converter. DC motors are significantly more energy efficient than AC motors and much easier to control. The major weakness of series fan powered terminal units until now, has been their low fan motor efficiency. The widely used single speed fractional horsepower PSC (Permanent Split Capacitor) induction motor in combination with an electronic SCR speed controller is extremely inefficient at typical operating conditions. Due to acoustical considerations, the fan motor is usually adjusted to operate at considerably less than full load (where PSC motor efficiencies may be as high as 62%). PSC motor efficiency drops off dramatically when turned down; typically by at least half. Installed PSC motor efficiencies are therefore typically in the range of only 12 – 45%. ECM's in contrast, maintain a high efficiency of 78 – 83% at all speeds.

In addition to lower operating costs, ECM / EPIC Fan Technology® allows Nailor to pre-set the fan airflow volume at the factory for constant volume units or modulate the fan across wide ranges as zone loads change.

Figure 1. shows the lower watts per cfm translating into lower operating costs as shown on Figure 2, and wider operating ranges of series terminals employing ECM versus PSC induction motors.

FEATURES AND BENEFITS OF ECM

Soft starts and slewed speed ramps are programmed into the ECM eliminating stress transmitted to the mounting bracket or hardware. They incorporate ball bearings providing permanent lubrication unlike sleeve bearings requiring a minimum RPM operation for oiling. The wider operating range of the ECM allows much more flexibility in zone applications. This feature alone provides several benefits; a simpler

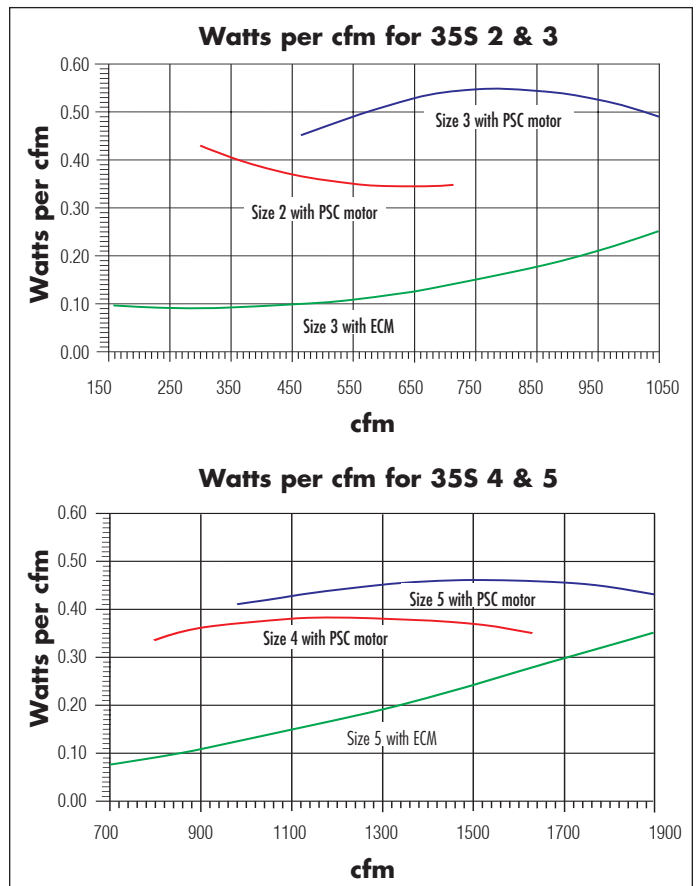

Figure 1. Power consumption comparison of ECM versus PSC motors.

product line to choose from, little or no equipment changes necessary when tenants change, more similar sized units on the job, decreased spare parts inventory and increased contractor flexibility. The low operating temperature of the ECM motor (essentially ambient) requires very little energy to offset the heat gain from the motor.

ECM/EPIC FAN TECHNOLOGY®

These features also extend the life of the ECM, which are expected to provide an average 90,000 hours of operation. This translates into about 25 years for a typical series fan powered terminal unit. In addition to these standard features are two primary benefits; energy savings and the ability to pre-set the fan airflow volume at the factory.

HOW DO YOU PRE-SET FAN AIRFLOW?

Pre-setting the fan airflow (cfm) has always been a problem for fan powered terminal manufacturers for two major reasons. First is that AC motors are not synchronous machines and second the RPM and consequently the unit cfm, changes when static pressure changes. The difficulty in pre-setting the fan lies in estimating the motor workload required at the job site in actual working conditions. The fan will not produce the same volume of air as it did at the factory without the duct work. Because there is no way to accurately predict the downstream static pressure as it would exist at the job site, it was impossible to pre-set the fan cfm. The ECM's are DC and inherently synchronous machines. The motors are programmed to calculate the work they are doing and then compare the work accomplished to the cfm requirement. The integral microprocessor based controller automatically adjusts the speed and torque in response to system pressure changes and pressure independent constant airflow operation is achieved without the need for an external flow sensor feedback loop.

Nailor series fan powered terminal units incorporate our own custom EPIC fan controller. An electronic PWM volume control device that allows adjustment of airflow volume. This value can be pre-set on the assembly line. It is field adjustable either manually using a screwdriver and voltmeter locally at the terminal or more conveniently, remotely using a 0 – 10 VDC analog output from a digital controller via the BAS. A fan volume versus DC volts calibration chart is provided. The importance of this feature is that the balancer never has to go into the ceiling to adjust the fan. This relieves the balancer of most of his work per zone on fan powered terminal units and related headaches. This also removes the uncertainty of diffuser flow measurement with hoods. Laboratory tests show the fan cfm to be accurate within +/- 5% of the factory set point. This is a huge benefit to the owner, the controls contractor, the mechanical contractor and the ceiling contractor.

ENERGY SAVINGS

The following graphs show the energy savings of units with ECM's compared to units with Nailor engineered PSC motors. Since PSC motors used by Nailor are built specifically for Nailor fan powered terminal units and are more efficient than those used by most of our competitors.

A comparison using Nailor units with ECM's and a competitor's units with PSC motors would show even greater savings.

The typical range of operation for the size 3 would be 200 to about 900 cfm (94 to 425 l/s). The typical range of operation for the size 5 unit would be 700 to 1700 cfm (330 to 802 l/s).

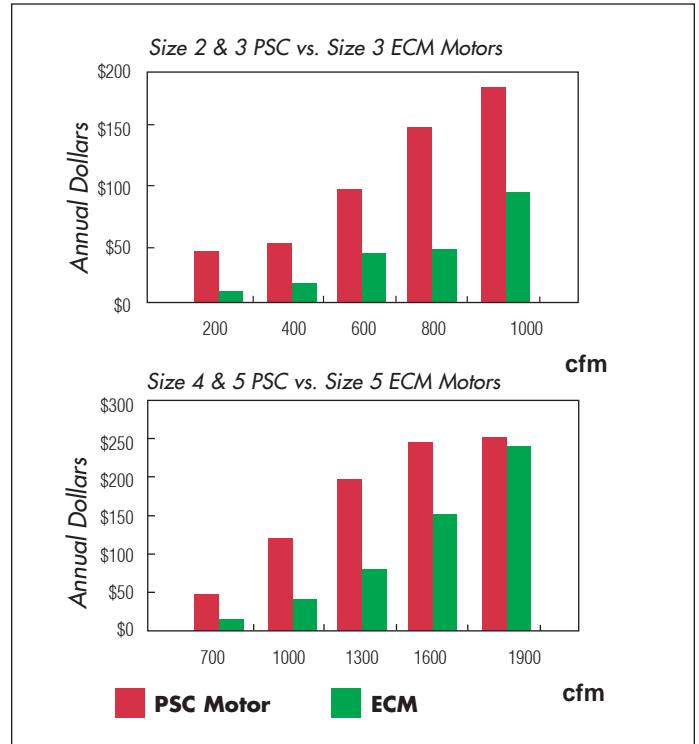

Figure 2. Typical operating cost comparison.

WHAT IS THE PAYBACK PERIOD ON ECM MOTORS?

The payback period varies. It depends on which unit you use, where you set the cfm, how much you run the equipment and what you are paying for electricity. The graphs above are calculated assuming 66 hours per week operations and \$.10 per kWh. If you run the equipment longer in your building or if you pay more for electricity, the payback will change proportionally. Considering the pre-set capability of the motor, there should be an up-front savings on balancing. That should be rebated to the owner and should be considered as part of the payback from the motor. Typically, with the balancing rebate and the operating expenses as shown above, the payback period should be anywhere from 6 to 18 months.

FAN POWERED TERMINAL UNITS

Recommended Primary Valve Airflow Ranges For All Fan Powered Terminal Units

The recommended airflow ranges below are for fan powered terminal units with pressure independent controls and are presented as ranges for total and controller specific minimum and maximum airflow. Airflow ranges are based upon maintaining reasonable sound levels and controller limits using Nailor's Diamond Flow Sensor as the airflow measuring device. For a given unit size, the minimum, auxiliary and the maximum flow setting must be within the range limits to ensure pressure independent operation, accuracy and repeatability.

Minimum airflow limits are based upon .02" w.g. (5 Pa) differential pressure signal from Diamond Flow Sensor on analog/digital controls and .03" (7.5) for pneumatic controllers. This is a realistic low limit for many transducers used in the digital controls industry. Check your controls supplier for minimum limits. Setting airflow minimums lower, may cause hunting and failure to meet minimum ventilation requirements.

The high end of the tabulated Total Airflow Range on pneumatic and analog electronic controls represents the Diamond Flow Sensor's differential pressure reading at 1" w.g. (249 Pa). The high end airflow range for digital controls is represented by the indicated transducer differential pressure.

ASHRAE 130 "Performance Rating of Air Terminals" is the method of test for the certification program. The "standard rating condition" (certification rating point) airflow volumes for each terminal unit size are tabulated below per AHRI Standard 880. These air volumes equate to an approximate inlet velocity of 2000 fpm (10.2 m/s).

When digital or other controls are mounted by Nailor, but supplied by others, these values are guidelines only, based upon experience with the majority of controls currently available. Controls supplied by others for factory mounting are configured and calibrated in the field. Airflow settings on pneumatic and analog controls supplied by Nailor are factory preset when provided.

Imperial Units, Cubic Feet per Minute

Inlet Size	Inlet Type	Total Airflow Range, cfm	Airflow at 2000 fpm Inlet Velocity (nom.), cfm	Range of Minimum and Maximum Settings, cfm							
				Pneumatic 3000 Controller		Analog Electronic Controls		Digital Controls			
						Transducer Differential Pressure (w.g.)					
				Min.	Max.	Min.	Max.	Min.	Max.	Max.	
.03	1.0	.02	1.0	.02	1.0	1.25	≥ 1.5				
4	Round	0 – 225	150	30	180	25	180	25	180	200	225
5		0 – 400	250	55	325	45	325	45	325	360	400
6		0 – 550	400	80	450	65	450	65	450	500	550
7		0 – 800	550	115	650	95	650	95	650	725	800
8		0 – 1100	700	155	900	125	900	125	900	1000	1100
10		0 – 1840	1100	260	1500	215	1500	215	1500	1675	1840
12		0 – 2500	1600	355	2050	290	2050	290	2050	2290	2500
14		0 – 3370	2100	475	2750	390	2750	390	2750	3075	3370
16		0 – 4510	2800	640	3700	520	3700	520	3700	4120	4510
12		Flat Oval	0 – 2500	1600	355	2050	290	2050	290	2050	2300
14	0 – 3125		2100	440	2550	360	2550	360	2550	2850	3125
16	0 – 3725		2800	525	3040	430	3040	430	3040	3400	3725
18	0 – 5265		3500	750	4300	610	4300	610	4300	4800	5265
14 x 8	Rect.	0 – 2450	1560	350	2000	290	2000	290	2000	2240	2450
14 x 10		0 – 2950	1900	420	2400	340	2400	340	2400	2700	2950

Metric Units, Liters per Second

Inlet Size	Inlet Type	Total Airflow Range, l/s	Airflow at 10.2 m/s Inlet Velocity (nom.), l/s	Range of Minimum and Maximum Settings, l/s							
				Pneumatic 3000 Controller		Analog Electronic Controls		Digital Controls			
						Transducer Differential Pressure (Pa)					
				Min.	Max.	Min.	Max.	Min.	Max.		
7.5	249	5	249	5	249	311	≥ 374				
4	Round	0 – 106	71	14	85	12	85	12	85	94	106
5		0 – 189	118	26	153	21	153	21	153	170	189
6		0 – 260	189	38	212	31	212	31	212	236	260
7		0 – 378	260	54	307	45	307	45	307	342	378
8		0 – 519	330	73	425	59	425	59	425	472	519
10		0 – 868	519	123	708	101	708	101	708	790	868
12		0 – 1180	755	168	967	137	967	137	967	1081	1080
14		0 – 1590	991	224	1298	184	1298	184	1298	1451	1590
16		0 – 2128	1321	302	1746	245	1746	245	1746	1944	2128
12		Flat Oval	0 – 1180	755	168	967	137	967	137	967	1085
14	0 – 1475		991	208	1203	170	1203	170	1203	1345	1475
16	0 – 1758		1321	248	1435	203	1435	203	1435	1604	1758
18	0 – 2485		1652	354	2029	288	2029	288	2029	2265	2485
14 x 8	Rect.	0 – 1156	736	165	944	137	944	137	944	1057	1156
14 x 10		0 – 1392	897	198	1133	160	1133	160	1133	1274	1392

PARALLEL FLOW VARIABLE VOLUME

35N SERIES

Models:

- 35N** No Heat
- 35NE** Electric Heat
- 35NW** Hot Water Heat



Model 35NW

The **35N Series** provides many standard design features and excellent sound performance when compared with other designs. The 35N offers a compact and economical design that provides excellent performance in the most demanding variable air volume/intermittent fan applications. The fan is mounted at ninety degrees to the primary airflow to provide optimum mixing.

STANDARD FEATURES:

- 20 ga. (1.0) galvanized steel construction.
- Round laminated 2 x 20 ga. (1.0) butterfly primary air damper with peripheral gasket. 90° rotation, CW to close. 1/2" (13) dia. plated steel drive shaft. An indicator mark on the end of the shaft shows damper-position. Damper leakage is less than 2% of nominal flow at 3" w.g. (750 Pa).
- Round minimum 6" (152) deep inlet collars for field duct connection.
- Pressure independent primary airflow control (also available in pressure dependent configuration).
- Multi-point averaging Diamond Flow sensor (pressure independent control only).
- Access panels on underside of terminal for ease of maintenance and service.
- Energy efficient PSC fan motor with thermal overload protection.
- Motor blower assembly mounted on special 16 ga. (1.61) angles and isolated from casing with rubber isolators.
- Adjustable PSC solid state fan speed controller with minimum voltage stop.
- Gasketed backdraft damper mounted on fan discharge restricts primary air escaping through the fan section into the ceiling plenum.

- Hinged door on fan controls enclosure.
- 3/4" (19) dual density insulation. Exposed edges coated to prevent air erosion. Meets requirements of NFPA 90A and UL 181.
- Available with electric or hot water supplementary heat.
- Hot water coils are mounted on discharge of 35NW unit with slip and drive duct connection.
- All controls are mounted on exterior of terminal providing ready access for field adjustment.
- Each terminal factory tested prior to shipment.
- Single point electrical and/or pneumatic main air connection.
- Discharge opening on 35N and 35NE designed for flanged duct connection.
- Full primary air valve low voltage NEMA 1 type enclosure for factory mounted DDC and analog electronic controls.

Controls:

- Nailor EZvav
- Analog electronic and pneumatic controls. Factory supplied, mounted and calibrated.
- Digital controls. Factory mounting and wiring of DDC controls supplied by BAS Controls Contractor.

Options:

- ECM/EPIC Fan Technology®.
- Induced air filter, 1" (25) thick, disposable type.
- Primary air valve enclosure for field mounted controls.
- Toggle disconnect switch units with electric heat, when disconnect is an electric heat option and includes fan).
- Various IAQ linings are available.
- Fan airflow switch for night shutdown.
- Night setback fan/heat cycle (pneumatic and analog).
- Fan unit fusing.
- Hanger brackets.
- Q option induced air attenuator.



Dimensions

Model Series 35N • Parallel Flow

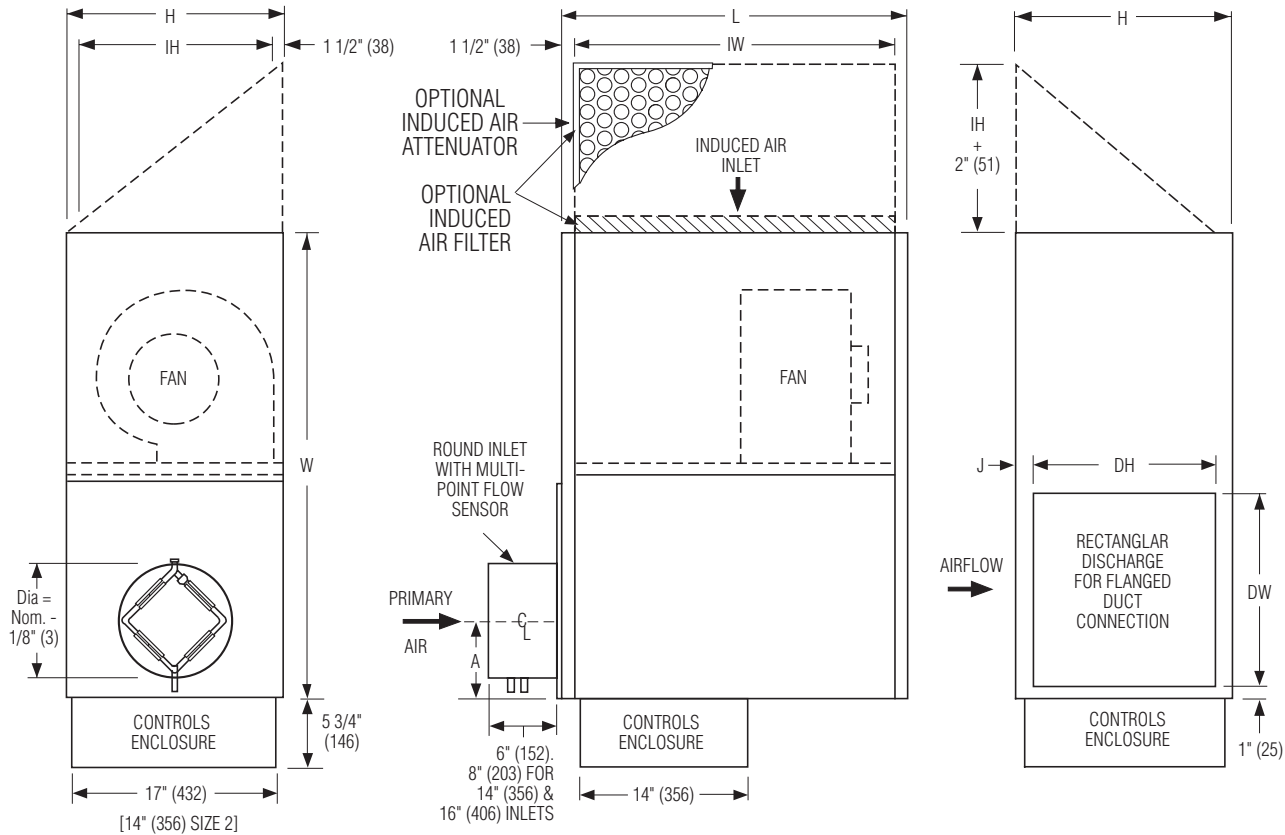

Right hand unit, top view illustrated. Controls mounted as standard on RH side as shown. Left hand units / terminals ordered with LH controls (optional), are built as mirror image. Inlet, discharge and control enclosure are opposite of the drawing.

Dimensional Data

Unit Size	Inlet Size	W	H	L	J	Induced Air Inlet IW x IH	Outlet Discharge DW x DH	Filter Size
2	6, 8, 10, 12 (152, 203, 254, 305)	34 3/4 (883)	14 (356)	27 9/16 (700)	1 (25)	24 9/16 x 10 3/4 (624 x 273)	16 x 12 (406 x 305)	26 x 13 (660 x 330)
3	8, 10, 12, 14 (203, 254, 305, 356)	38 1/4 (972)	18 (457)	28 9/16 (725)	1 1/2 (38)	25 9/16 x 14 3/4 (649 x 375)	16 x 15 (406 x 381)	27 x 17 (686 x 432)
5	10, 12, 14 (254, 305, 356)	45 5/8 (1159)	18 (457)	34 1/2 (876)	1 1/2 (38)	31 1/2 x 14 3/4 (800 x 375)	24 x 15 (610 x 381)	33 x 17 (838 x 432)
6	12, 14, 16 (305, 356, 406)	50 3/4 (1289)	20 (508)	36 (914)	1 1/4 (32)	33 x 16 3/4 (838 x 426)	28 x 17 1/2 (711 x 445)	35 x 19 (889 x 483)

Primary Inlet Dimensions

Inlet Size	Dim. A
6	5 (127)
8	6 (152)
10	7 (178)
12	8 (203)
14	9 (229)
16	10 (254)

Dimensions

Model Series 35N • Parallel Flow

Hot Water Coil Section

Model 35NW

Available in one, two or three row. Coil section installed on unit discharge. Right hand coil connection looking in direction of airflow standard (shown). Left hand is optional (terminals are inverted / built as mirror image). Connections must be selected same hand as controls enclosure location.

Standard Features:

- Coil is mounted on unit discharge.
- 1/2" (13) copper tubes.
- Aluminum ripple fins.
- Sweat Connections:
Size 2 and 3: 1 Row 1/2" (13); O.D. male solder.
All others: 7/8" (22); O.D. male solder.
- Bottom access panel for inspection and coil cleaning.
- Discharge opening for slip and drive connection.

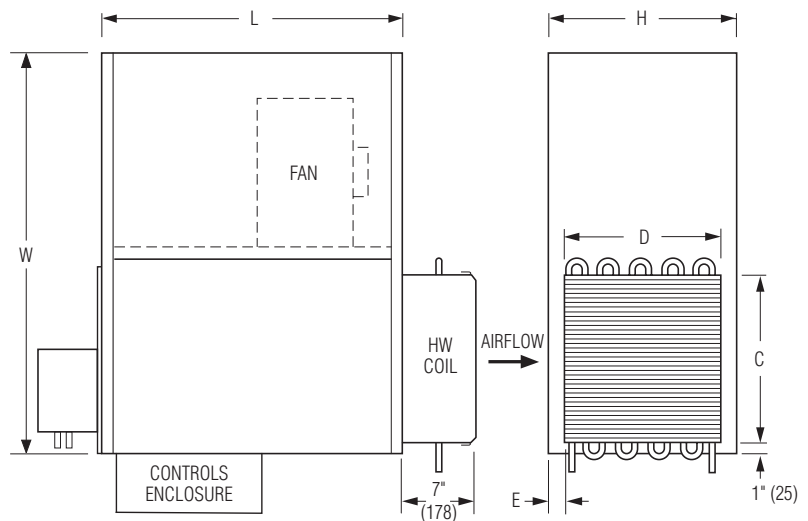

Unit Size	Outlet Duct Size C x D	W	H	L	E
2	16 x 12 1/2 (406 x 318)	34 3/4 (883)	14 (356)	27 9/16 (700)	3/4 (19)
3	16 x 15 (406 x 381)	38 1/4 (972)	18 (457)	28 9/16 (725)	1 1/2 (38)
5	24 x 15 (610 x 381)	45 5/8 (1159)	18 (457)	34 1/2 (876)	1 1/2 (38)
6	28 x 17 1/2 (737 x 445)	50 3/4 (1289)	20 (508)	36 (914)	1 1/4 (32)

Electric Coil Section

Model 35NE

Standard Features:

- Coil installed on unit discharge.
- Insulated coil element wrapper.
- Automatic reset high limit cut-outs (one per element).
- Single point electrical connection for entire terminal unit (except 600V/3 ph., which comes with 120V/1 ph. motor).
- Magnetic contactors per stage.
- Class A 80/20 Ni/Cr wire.
- Positive pressure airflow switch.
- Flanged outlet duct connection.
- Terminal unit with coil is ETL Listed as an assembly.
- Controls mounted as standard on RH side as shown. Terminals ordered with LH controls (optional) are built as mirror image.

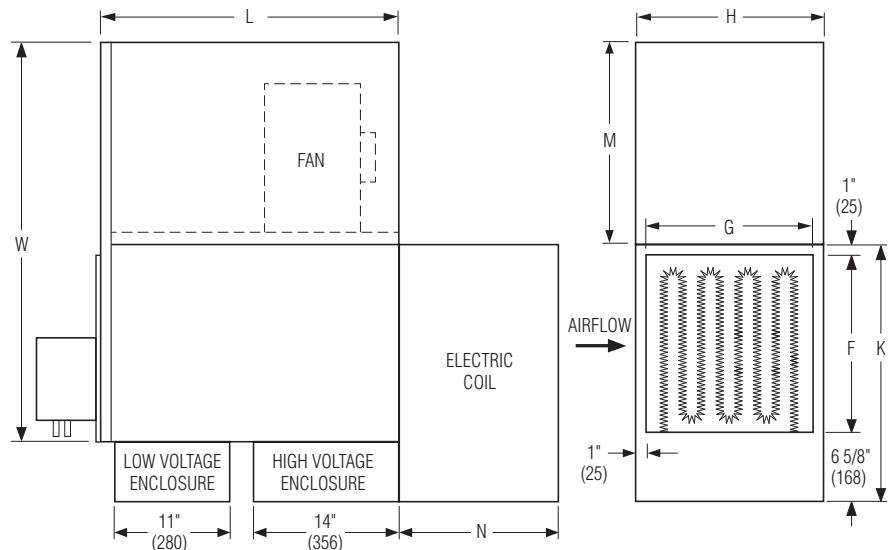

Standard Supply Voltage (60 Hz):

- Single phase: 120, 208, 240 & 277V.
- Three phase: 208, 480 (4 wire wye) and 600V (dual point connection).

Options:

- SCR control.
- SCR control with discharge temperature control.
- Toggle disconnect switch (includes fan).
- Door interlock disconnect switch.
- Mercury contactors.
- Power circuit fusing.
- Dust tight construction.
- Manual reset secondary thermal cut out.

Unit Size	Outlet Duct Size F x G	K	H	M	N
2	17 x 12 (432 x 305)	24 5/8 (626)	14 (356)	15 7/8 (403)	12 1/2 (318)
3	17 x 16 (432 x 406)	24 5/8 (626)	18 (457)	19 3/8 (492)	15 1/4 (387)
5	25 x 16 (635 x 406)	32 5/8 (829)	18 (457)	18 3/4 (476)	15 1/4 (387)
6	29 x 18 (737 x 457)	36 5/8 (930)	20 (508)	19 7/8 (505)	15 1/4 (387)

Performance Data

PSC Motor Fan Curves – Airflow vs. Downstream Static Pressure

35N Series • Parallel Flow

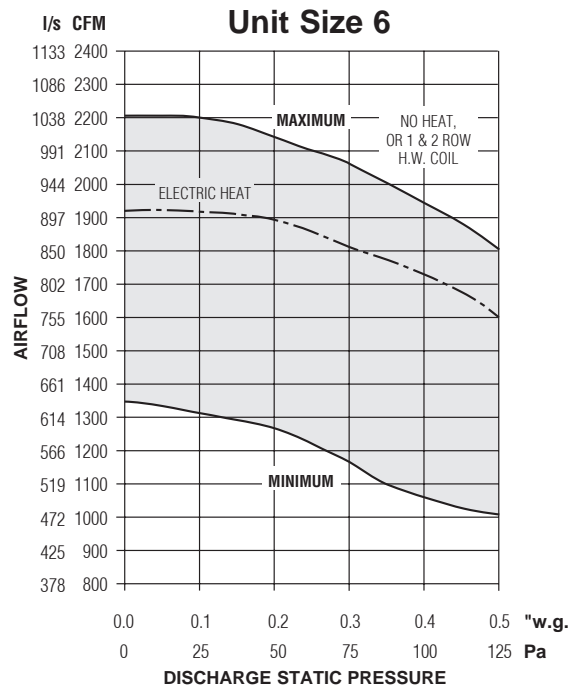
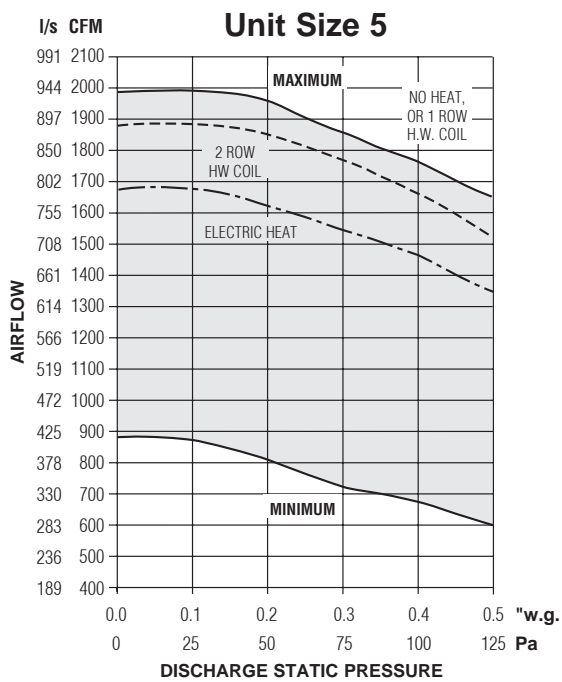
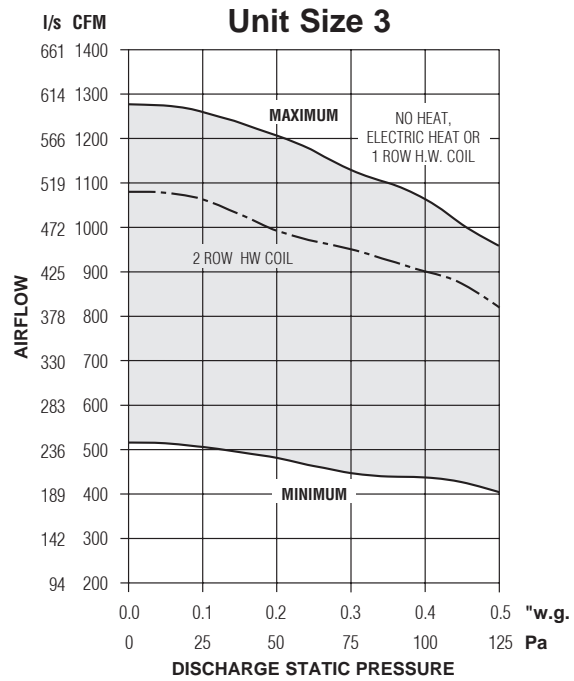
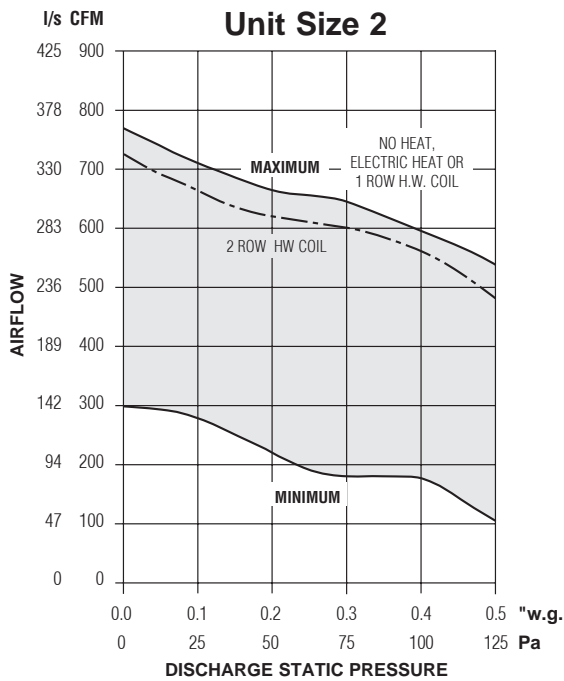

Electrical Data

Unit Size	Motor H.P.	PSC MOTOR FLA			
		120/1/60	208/1/60	240/1/60	277/1/60
2	1/10	2.8	1.4	1.4	1.2
3	1/4	4.7	2.0	2.0	1.7
5	1/2	9.9	4.1	4.1	3.5
6	3/4	8.4	3.8	3.8	3.7

FLA = Full load amperage

- Fan curves shown are applicable to 120, 208, 240 and 277 volt, single phase PSC motors.

Performance Data

ECM Motor Fan Curves – Airflow vs. Downstream Static Pressure

35N Series • Parallel Flow

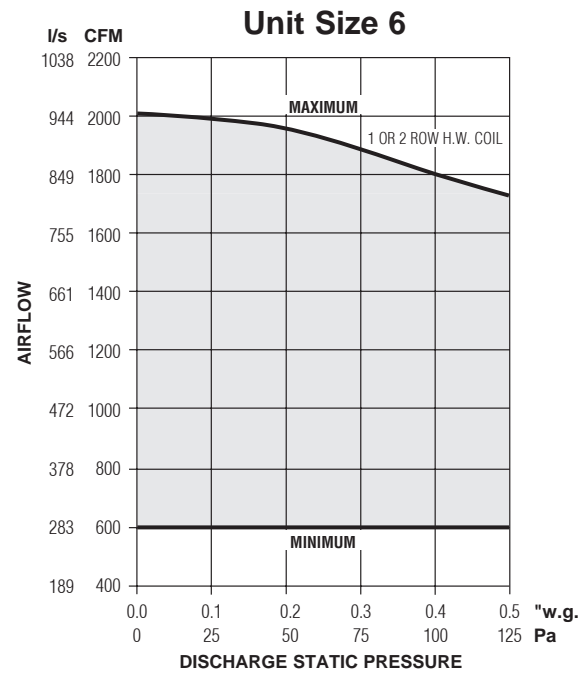
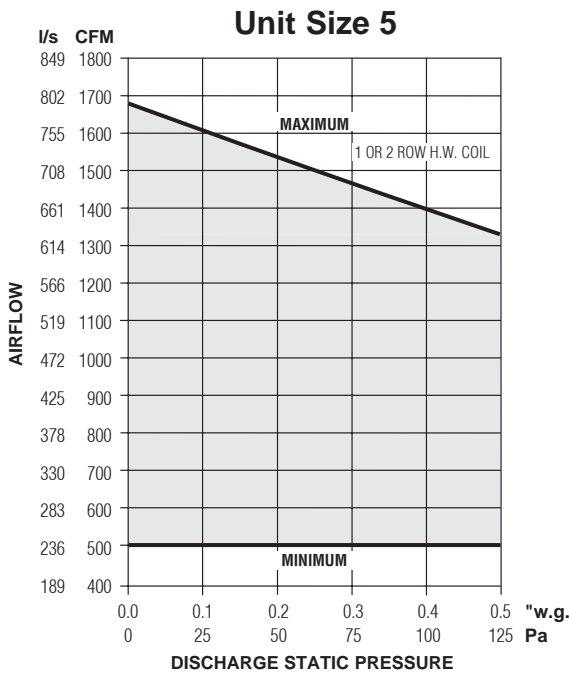
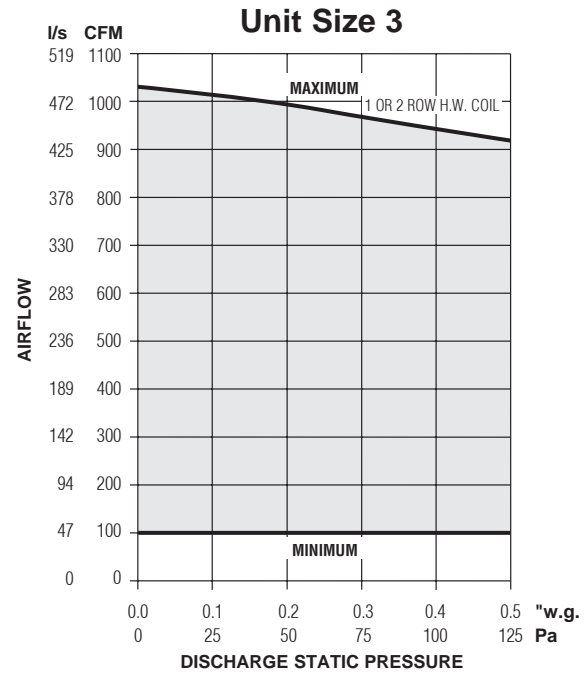
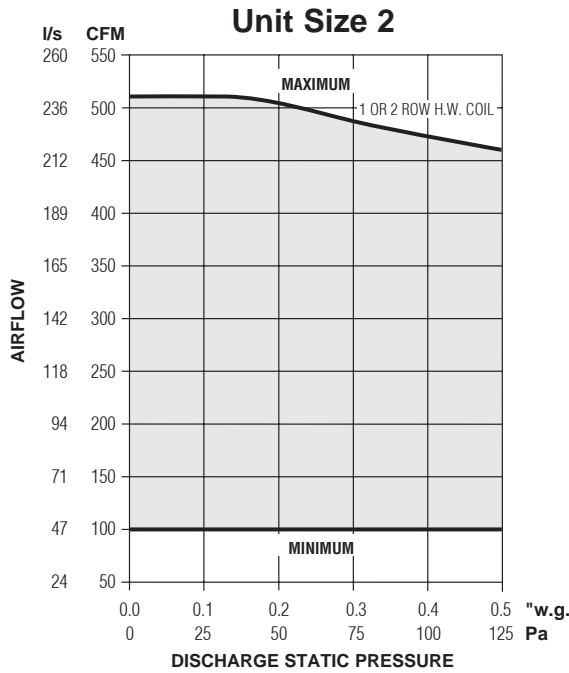

Electrical Data

Unit Size	EPIC ECM Motor FLA				
	Motor HP	120V	208V	240V	277V
2	*	3.9	2.2	2.2	1.8
3	*	6.9	3.9	3.9	3.5
5	*	11.9	6.8	6.8	6.1
6	*	13.7	7.9	7.9	6.7

* The ECM is a variable horsepower motor. Refer to Selectworks Schedule for actual power consumption.
 FLA = Full load amperage.
 All motors are single phase/60 Hz.

NOTES:

- The ECM is pressure independent and constant volume in operation at factory or field set point within the shaded area. Airflow does not vary with changing static pressure conditions. The motor compensates for any changes in external static pressure or induced air conditions such as filter loading.
- Airflow can be set to operate on horizontal performance line at any point within shaded area using the solid state volume controller provided.
- Fan curves shown are applicable to 120/240, 208 and 277 volt, single phase ECM's. ECM's, although DC in operation, include a built-in AC/DC converter.

Performance Data • NC Level Application Guide

Model Series 35N • Parallel Flow • 100% Primary Air • Cooling Cycle

Fiberglass Liner

Unit Size	Inlet Size	Airflow		Min. Inlet ΔPs		NC Levels @ Inlet pressure (ΔPs) shown									
						DISCHARGE					RADIATED				
						Min. ΔPs	0.5" w.g. (125 Pa)	1.0" w.g. (250 Pa)	1.5" w.g. (375 Pa)	2.0" w.g. (500 Pa)	Min. ΔPs	0.5" w.g. (125 Pa)	1.0" w.g. (250 Pa)	1.5" w.g. (375 Pa)	2.0" w.g. (500 Pa)
2	6	500	236	0.49	122	-	-	24	31	36	22	25	32	35	38
		400	189	0.15	37	-	-	24	30	33	20	24	30	33	34
		300	142	0.18	45	-	-	25	29	33	-	23	26	30	32
		200	94	0.08	20	-	-	23	25	26	-	20	23	28	30
		100	47	0.02	5	-	-	-	-	-	-	-	22	26	29
	8	875	413	0.30	75	-	-	25	30	36	-	-	29	31	35
		700	330	0.20	50	-	-	24	31	33	-	-	26	32	34
		525	248	0.11	27	-	-	23	29	33	-	-	23	30	32
		350	165	0.05	12	-	-	20	24	26	-	-	20	26	31
		175	83	0.01	2	-	-	-	-	27	-	-	22	26	28
	10	1375	649	0.40	99	-	-	25	33	36	21	24	29	34	37
		1100	519	0.24	60	-	-	24	30	33	-	20	26	33	36
		825	389	0.15	37	-	-	21	26	30	-	-	25	30	34
		550	260	0.06	15	-	-	20	21	23	-	-	23	26	30
		275	130	0.02	5	-	-	-	-	28	-	-	20	24	26
	12	2000	944	0.45	112	-	-	25	33	36	32	32	35	35	37
		1600	755	0.30	75	-	-	25	31	34	26	29	28	31	34
		1200	566	0.18	45	-	-	24	28	30	-	-	24	29	32
		800	378	0.08	20	-	-	-	24	24	-	-	20	22	25
		400	189	0.02	5	-	-	-	-	27	-	-	-	21	24
3	8	875	413	0.24	60	-	-	26	31	34	20	21	30	33	36
		700	330	0.15	37	-	-	24	30	31	-	20	28	33	34
		525	248	0.08	20	-	-	23	26	30	-	-	22	26	30
		350	165	0.04	10	-	-	-	24	23	-	-	-	23	28
		175	83	0.01	2	-	-	-	-	26	-	-	-	20	23
	10	1375	649	0.25	62	-	-	28	34	37	26	30	33	36	39
		1100	519	0.16	40	-	-	25	31	35	-	26	29	34	36
		825	389	0.09	22	-	-	23	29	31	-	22	26	30	32
		550	260	0.04	10	-	-	20	25	29	-	-	22	26	29
		275	130	0.01	2	-	-	-	-	22	-	-	21	22	23
	12	2000	944	0.34	85	-	-	28	31	36	-	23	29	33	36
		1600	755	0.22	55	-	-	24	31	34	-	-	25	33	35
		1200	566	0.12	30	-	-	23	28	29	-	-	25	29	33
		800	378	0.05	12	-	-	-	22	21	-	-	21	24	26
		400	189	0.01	2	-	-	-	20	29	-	-	-	20	23
14	2625	1239	0.39	97	21	21	28	33	36	22	23	30	33	37	
	2100	991	0.25	62	-	-	25	30	33	-	20	28	31	34	
	1575	743	0.14	35	-	-	21	26	29	-	-	22	29	32	
	1050	495	0.06	15	-	-	-	22	23	-	-	21	26	29	
	525	248	0.02	5	-	-	-	20	28	-	-	-	23	24	
5	10	1375	649	0.26	65	-	-	28	31	35	-	22	26	33	35
		1100	519	0.17	42	-	-	24	29	31	-	24	26	31	34
		825	389	0.11	27	-	-	21	26	29	-	-	23	26	29
		550	260	0.04	10	-	-	20	24	28	-	-	-	25	26
		275	130	0.01	2	-	-	-	-	28	-	-	-	-	21
	12	2000	944	0.24	60	-	-	26	33	35	23	26	35	36	39
		1600	755	0.15	37	-	-	25	30	33	20	26	31	34	36
		1200	566	0.08	20	-	-	21	26	26	-	23	26	30	33
		800	378	0.03	7	-	-	-	21	24	-	20	22	25	28
		400	189	0.01	2	-	-	-	-	21	-	-	21	23	23
14	2625	1239	0.30	75	-	-	25	30	33	20	22	28	31	34	
	2100	991	0.19	47	-	-	23	26	28	-	-	25	28	31	
	1575	743	0.10	25	-	-	-	23	24	-	-	22	25	28	
	1050	495	0.04	10	-	-	-	21	22	-	-	-	22	25	
	525	248	0.01	2	-	-	-	20	28	-	-	-	-	23	
6	12	2000	944	0.21	52	-	-	25	30	33	-	20	29	33	35
		1600	755	0.13	32	-	-	23	29	29	-	-	28	30	30
		1200	566	0.07	17	-	-	20	24	24	-	20	21	24	29
		800	378	0.04	10	-	-	-	21	22	-	-	-	21	24
		400	189	0.01	2	-	-	-	-	28	-	-	-	-	20
	14	2625	1239	0.22	55	-	23	29	34	37	28	35	39	40	41
		2100	991	0.14	35	-	-	26	31	35	22	31	35	36	38
		1575	743	0.07	17	-	-	24	30	30	-	26	30	33	34
		1050	495	0.03	7	-	-	20	25	28	-	22	25	28	29
		525	248	0.01	2	-	-	-	22	25	-	-	20	22	24
16	3425	1616	0.25	62	25	25	28	30	34	25	26	30	31	35	
	2750	1298	0.16	40	-	-	23	29	29	-	23	25	29	31	
	2050	967	0.08	20	-	-	20	25	26	-	-	23	26	28	
	1375	649	0.04	10	-	-	-	23	26	-	22	20	22	24	
	700	330	0.01	2	-	-	-	22	26	-	-	-	-	21	

Performance Notes:

1. NC Levels are calculated based on procedures as outlined on page C160.
2. Dash (-) in space indicates a NC less than 20.

Performance Data • Discharge Sound Power Levels

Model Series 35N • Parallel Flow • 100% Primary Air • Cooling Cycle

Fiberglass Liner



Unit Size	Inlet Size	Airflow		Min. inlet ΔPs "w.g. Pa	100% Primary Air – Sound Power Octave Bands @ Inlet pressure (ΔPs) shown																																		
					Minimum ΔPs							0.5" w.g. (125Pa) ΔPs							1.0" w.g. (249Pa) ΔPs							1.5" w.g. (375Pa) ΔPs							2.0" w.g. (500Pa) ΔPs						
					2	3	4	5	6	7	2	3	4	5	6	7	2	3	4	5	6	7	2	3	4	5	6	7	2	3	4	5	6	7					
2	6	500	236	0.45	133	61	57	52	49	46	47	62	58	53	50	47	48	69	65	59	55	52	54	72	71	64	58	55	58	74	75	69	60	57	61				
		400	189	0.15	37	57	52	48	45	41	40	61	56	51	48	45	44	67	65	58	53	50	51	72	70	63	56	54	57	72	72	67	58	56	60				
		300	142	0.17	42	52	46	43	40	34	30	61	57	50	47	44	43	66	65	57	51	50	51	67	68	62	55	53	56	69	71	66	57	55	59				
		200	94	0.08	19	-	42	37	30	20	-	59	56	49	45	43	43	62	63	56	50	49	50	63	65	60	54	52	54	63	66	64	57	54	57				
		100	47	0.01	3	-	-	-	-	-	-	50	53	48	44	40	38	53	57	56	50	44	43	52	56	60	54	47	47	52	57	61	57	50	50				
	8	875	413	0.30	75	56	54	50	48	45	45	62	60	54	52	49	49	71	67	61	57	53	55	77	71	65	59	56	60	79	76	69	57	57	61				
		700	330	0.20	50	55	51	45	44	40	38	65	60	53	50	48	48	70	66	59	54	52	54	74	72	65	56	56	59	75	73	67	56	57	60				
		525	248	0.11	27	-	44	38	38	32	29	61	57	49	46	45	43	67	64	57	50	51	52	71	69	64	54	55	57	71	72	66	54	56	58				
		350	165	0.05	12	-	38	31	29	20	-	58	54	47	44	43	41	62	62	55	48	50	50	64	65	60	52	54	55	64	67	64	54	54	55				
		175	83	0.01	2	-	-	-	-	-	-	55	52	46	43	42	39	55	59	54	47	48	47	56	57	60	50	53	51	58	59	60	50	59	64				
	10	1375	649	0.40	99	60	58	55	50	50	49	62	61	57	51	51	51	69	67	64	55	55	57	75	73	69	59	58	62	76	76	71	59	58	63				
		1100	519	0.24	60	56	52	50	45	44	41	61	59	56	49	49	48	68	66	62	53	54	55	72	71	67	57	57	61	73	73	67	57	58	62				
		825	389	0.15	37	51	46	43	39	36	32	60	57	53	46	47	45	65	64	59	50	52	53	68	68	65	54	56	62	68	71	68	54	56	59				
		550	260	0.06	15	-	38	34	29	23	-	56	53	48	43	43	40	60	62	57	48	51	51	63	63	62	52	54	57	62	64	64	53	53	56				
		275	130	0.02	5	-	-	-	-	-	-	51	51	47	42	42	38	53	56	55	46	47	47	55	58	61	50	51	52	55	60	63	62	61	65				
	12	2000	944	0.45	112	62	59	55	52	50	51	62	59	55	52	50	51	68	67	63	57	56	58	74	73	67	59	59	62	76	76	71	60	60	64				
		1600	755	0.30	75	57	54	49	46	44	43	61	59	55	50	50	49	69	67	62	54	55	57	72	72	66	58	58	61	73	74	69	58	58	63				
		1200	566	0.18	45	51	45	42	38	35	30	61	57	53	47	46	46	67	66	60	52	54	55	68	69	64	55	57	60	69	71	67	56	56	59				
		800	378	0.08	20	50	39	34	31	26	-	57	53	49	44	45	42	61	61	56	49	51	51	63	66	62	53	55	57	66	66	64	54	53	55				
		400	189	0.02	5	49	35	29	23	-	-	52	50	46	42	42	38	54	57	56	48	48	48	56	59	59	51	51	51	57	60	62	59	58	63				
3	8	875	413	0.24	60	59	55	50	48	46	46	64	59	53	52	49	50	72	68	61	57	55	57	76	72	64	59	57	61	75	74	66	59	58	62				
		700	330	0.15	37	55	50	44	44	41	39	67	58	52	51	49	49	70	66	58	54	53	55	73	71	62	56	56	59	75	72	65	56	57	61				
		525	248	0.08	20	-	41	36	35	31	27	62	57	49	46	46	45	66	64	56	50	52	53	68	67	60	53	54	57	68	70	63	54	56	58				
		350	165	0.04	10	-	-	28	25	-	-	57	52	44	42	43	41	62	61	53	47	50	51	64	65	58	51	53	56	64	64	61	53	52	53				
		175	83	0.01	2	-	-	-	-	-	-	52	48	44	40	41	38	54	54	52	46	47	47	55	56	56	49	50	51	55	61	59	59	59	63				
	10	1375	649	0.35	75	66	59	53	50	50	49	67	61	57	52	53	53	71	69	63	57	57	59	74	74	67	59	60	64	76	77	70	61	62	66				
		1100	519	0.16	40	60	53	48	45	44	41	64	59	54	50	50	50	69	67	60	54	56	57	71	72	65	57	59	62	74	75	68	60	61	65				
		825	389	0.10	25	53	47	44	42	37	31	62	57	52	48	47	47	67	65	58	52	55	56	69	70	63	55	58	61	71	72	66	58	60	64				
		550	260	0.04	11	-	42	42	39	33	27	58	54	49	45	49	45	63	62	56	50	53	54	64	66	61	54	57	59	65	69	65	56	59	62				
		275	130	0.01	2	-	39	40	35	26	18	53	53	49	44	45	44	55	58	56	49	51	52	57	60	58	53	55	56	58	62	60	55	57	59				
	12	2000	944	0.34	85	62	59	58	51	50	50	64	62	59	52	52	53	70	69	64	55	57	59	73	72	67	58	59	63	75	76	70	59	60	65				
		1600	755	0.22	55	57	53	52	45	44	41	62	60	56	49	51	50	68	66	61	53	56	57	71	72	65	56	59	62	72	74	69	57	59	64				
		1200	566	0.12	30	50	46	43	37	34	28	59	56	52	45	48	46	66	65	59	51	55	56	67	69	63	54	58	60	68	70	66	54	57	61				
		800	378	0.05	12	-	36	31	24	-	-	56	51	47	42	44	41	60	61	57	49	54	55	61	63	59	51	56	58	63	63	61	53	55	57				
		400	189	0.01	2	-	35	29	20	-	-	49	49	46	41	45	42	52	55	53	47	50	51	56	58	57	50	54	56	54	58	57	62	62	66				
	14	2625	1239	0.39	97	66	64	60	55	52	50	67	64	61	55	54	53	72	69	64	58	58	60	74	73	66	60	60	63	75	76	70	59	61	65				
		2100	991	0.25	62	62	59	54	49	47	43	64	61	56	51	52	50	69	67	61	55	57	58	70	71	64	57	59	62	73	73	68	57	60	63				
		1575	743	0.14	35	55	52	45	40	36	30	60	56	51	47	49	46	66	64	58	52	55	56	68	68	62	55	58	60	69	70	65	56	58	61				
		1050	495	0.06	15	48	41	34	29	22	-	56	52	47	44	47	44	60	60	56	49	53	54	62	64	60	52	56	58	64	65	63	54	56	59				
		525	248	0.02	5	-	-	24	-	-	-	49	49	45	42	44	42	54	57	53	48	51	52	55	59	57	51	53	56	58	62	61	59	60	64				
5	10	1375	649	0.26	65	59	55	55	50	49	49	65	61	59	52	52	53	71	69	64	56	56	59	73	72	66	57	58	61	72	75	70	57	59	63				
		1100	519	0.17	42	53	49	48	43	41	39	62	58	55	48	49	49	69	66	61	52	54	56	71	70	65	56	57	61	72	72	68	56	58	62				
		825	389	0.11	27	50	43	42	36	34	29	61	56	52	45	47	46	66	64	58	50	53	54	67	68	62	53	56	59	69	70	66	54	57	61				
		550	260	0.04	10	-	37	32	27	-	-	58	53	48	43	45	43	63	62	57	49	52	53	63	65	61	51	54	57	66	68	65	53	54	57				
		275	130	0.01	2	-	-	-	-	-	-	51	49	46	40	41	40	53	54	53	45	48	48	55	58	57	50	52	54	56	60	60	61	61	66				
	12	2000	944	0.28	71	63	58	56	51	50	50	67	61	58	53	52	53	71	68	63	56	56	58	74	73	67	58	59	62	76	75	70	60	61	64				
		1600	755	0.15	37	59	53	51	47	45	43	65	59	55	49	45	43	7																					

Performance Data • Radiated Sound Power Levels
 Model Series 35N • Parallel Flow • 100% Primary Air • Cooling Cycle
 Fiberglass Liner

Unit Size	Inlet Size	Airflow		Min. inlet ΔPs		100% Primary Air – Sound Power Octave Bands @ Inlet pressure (ΔPs) shown																																		
						Minimum ΔPs		0.5" w.g. (125Pa) ΔPs					1.0" w.g. (249Pa) ΔPs					1.5" w.g. (375Pa) ΔPs					2.0" w.g. (500Pa) ΔPs																	
						"w.g.	Pa	2	3	4	5	6	7	2	3	4	5	6	7	2	3	4	5	6	7	2	3	4	5	6	7	2	3	4	5	6	7			
2	6	500	236	0.45	133	54	50	48	42	35	31	58	53	51	45	38	33	65	61	57	49	42	38	67	64	60	51	44	42	69	66	63	52	45	44					
		400	189	0.15	37	-	45	46	40	32	26	57	51	50	44	36	30	64	58	55	47	40	37	66	62	58	48	42	40	66	63	59	49	43	42					
		300	142	0.17	42	-	40	43	38	29	21	56	50	49	43	35	29	61	55	52	44	38	34	62	58	55	45	40	38	63	59	57	46	41	41					
		200	94	0.08	19	-	37	42	36	28	19	53	46	46	40	32	25	55	51	49	42	36	31	56	54	53	42	38	36	56	55	55	44	40	39					
		100	47	0.01	3	-	35	38	34	25	-	48	41	42	33	25	18	48	47	48	37	31	26	49	47	52	39	34	31	49	47	54	42	37	34					
	8	875	413	0.30	75	50	46	41	36	32	29	55	50	45	40	35	32	65	57	52	42	39	38	67	61	56	45	43	42	67	64	59	45	44	44					
		700	330	0.20	50	49	43	37	32	29	24	54	49	43	36	33	29	62	57	51	39	38	36	65	61	57	42	41	41	66	63	59	44	43	43					
		525	248	0.11	27	-	36	31	27	-	-	53	48	41	33	32	29	58	54	49	36	37	35	61	58	55	39	39	39	61	61	57	42	41	41					
		350	165	0.05	12	-	35	28	24	-	-	51	45	39	30	30	26	53	51	46	33	35	33	55	55	52	37	38	37	53	58	56	40	40	40					
		175	83	0.01	2	-	-	-	-	-	-	45	41	36	28	27	22	46	50	48	33	33	31	45	49	52	36	36	33	45	48	53	39	38	36					
	10	1375	649	0.40	99	56	51	47	39	37	36	57	53	50	41	39	38	64	58	54	43	42	43	67	63	58	46	44	47	69	66	61	48	46	49					
		1100	519	0.24	60	51	46	42	34	32	30	54	50	46	36	35	33	61	56	52	40	40	40	64	62	56	43	43	45	66	64	61	46	45	48					
		825	389	0.15	37	46	39	34	28	26	21	53	47	43	33	33	32	59	55	51	37	38	39	59	59	55	41	41	44	61	61	59	44	44	48					
		550	260	0.06	15	-	34	26	-	-	-	51	45	39	30	31	29	53	53	49	35	37	37	54	53	52	39	40	42	56	56	55	42	42	46					
		275	130	0.02	5	-	-	-	-	-	-	45	42	38	28	29	25	47	48	46	34	35	35	47	49	50	37	38	39	47	50	52	41	41	42					
	12	2000	944	0.45	112	62	59	57	49	42	38	62	59	57	49	42	38	68	63	60	49	43	40	69	64	60	49	45	44	69	66	61	50	47	47					
		1600	755	0.30	75	59	55	52	43	35	30	60	57	54	43	36	31	64	58	53	43	41	38	65	61	56	46	44	43	66	63	59	49	47	46					
		1200	566	0.18	45	52	48	45	35	27	-	55	49	44	34	32	26	59	54	50	40	39	35	60	58	54	43	43	42	62	60	57	45	44	45					
		800	378	0.08	20	44	38	33	22	-	-	50	44	38	32	32	26	52	49	46	36	38	35	54	50	48	38	40	41	56	53	51	42	42	46					
		400	189	0.02	5	42	34	26	-	-	-	41	37	34	28	30	21	46	44	44	34	37	34	47	46	47	37	39	41	48	48	50	40	41	48					
3	8	875	413	0.24	60	49	49	46	42	40	38	55	51	47	43	40	38	63	60	55	47	45	45	65	62	57	48	46	47	67	65	60	50	48	50					
		700	330	0.15	37	48	43	41	37	34	31	53	49	46	41	38	36	62	58	52	45	43	42	65	62	57	48	46	47	65	63	59	49	47	49					
		525	248	0.08	20	-	35	32	27	-	-	50	46	41	35	33	30	56	53	48	39	39	38	57	56	52	42	41	42	58	59	55	45	43	46					
		350	165	0.04	10	-	34	23	-	-	-	47	42	36	31	29	27	52	50	45	37	36	36	52	53	49	40	39	40	53	56	53	44	42	44					
		175	83	0.01	2	-	-	-	-	-	-	45	40	36	29	28	25	46	46	45	35	33	33	46	47	46	36	36	36	47	49	49	41	39	41					
	10	1375	649	0.35	75	63	51	48	42	37	32	66	58	53	46	41	37	68	62	57	49	43	40	70	65	60	51	45	44	71	68	62	52	47	46					
		1100	519	0.16	40	57	47	45	39	33	24	63	54	50	44	38	32	65	59	54	46	41	37	67	63	57	48	43	41	69	65	60	50	44	43					
		825	389	0.10	25	-	43	42	37	29	19	59	51	48	41	35	29	62	57	51	43	38	36	65	60	54	44	41	40	66	61	57	45	42	42					
		550	259	0.04	11	-	40	41	35	27	-	55	48	45	39	33	26	58	52	48	39	36	33	59	56	52	41	39	38	61	57	54	43	41	40					
		275	130	0.01	2	-	-	38	34	26	-	50	44	43	36	30	23	51	48	47	37	33	29	53	50	48	40	36	34	52	52	49	41	38	36					
	12	2000	944	0.34	85	53	49	45	40	38	34	54	53	49	43	40	38	60	58	54	45	44	44	64	62	57	48	48	48	65	65	60	50	50	51					
		1600	755	0.22	55	48	44	41	35	32	27	51	49	44	38	36	32	59	56	51	43	44	42	62	62	56	47	47	45	63	64	59	48	48	49					
		1200	566	0.12	30	42	37	33	27	21	-	52	48	43	37	37	33	56	56	49	41	42	41	58	59	54	44	45	45	59	61	58	47	47	48					
		800	378	0.05	12	-	-	23	-	-	-	48	44	37	33	33	28	51	50	47	38	40	38	53	53	50	41	43	43	52	54	52	44	45	46					
		400	189	0.01	2	-	-	-	-	-	-	43	40	35	30	31	27	45	45	43	36	38	37	47	47	46	40	41	42	50	50	49	43	44	45					
	14	2625	1239	0.39	97	55	51	48	42	38	34	55	52	49	44	39	36	63	59	55	46	44	44	64	62	57	48	47	48	66	66	61	51	49	51					
		2100	991	0.25	62	51	46	43	36	32	27	54	50	46	38	37	33	60	58	52	43	43	43	62	61	56	46	46	47	64	62	59	48	48	50					
		1575	743	0.14	35	46	40	35	28	22	-	52	46	42	35	35	31	56	53	48	40	41	40	60	58	54	44	45	46	61	59	57	47	48	47					
		1050	495	0.06	15	-	-	22	-	-	-	49	43	39	33	34	30	52	51	47	39	40	40	55	54	52	43	44	45	57	55	54	45	46	48					
		525	248	0.02	5	-	-	-	-	-	-	40	38	32	34	34	34	47	46	44	37	39	40	50	50	49	41	43	44	49	51	50	43	45	45					
5	10	1375	649	0.26	65	49	43	42	39	38	34	55	52	48	42	41	40	62	57	51	44	43	43	65	62	55	46	45	48	63	64	58	48	47	49					
		1100	519	0.17	42	45	40	39	36	34	29	59	54	50	43	39	37	60	57	50	42	42	42	61	61	54	44	44	47	63	63	57	46	46	49					
		825	389	0.11	27	45	36	33	30	26	-	51	47	39	33	33	31	56	54	47	39	40	40	58	57	51	41	42	44	57	59	54	44	43	46					
		550	260	0.04	10	-	33	28	21	-	-	48	44	37	31	31	30	52	50	44	36	37	37	56	56	50	40	41	43	55	56	52	42	42	45					
		275	130	0.01	2	-	-	40	35	28	29	28	-	40	35	28	29	28	-	43	42	33	35	35	-	44	45	37	38	39	47	47	40	41	42					
	12	2000	943	0.28	71	60	52	49	44	40	37	63	56	51	45	42	39	70	62	55	47	45	44	71	65	58	49	47	47	73	67	61	51	49	49					
		1600	755	0.15	37	55	49	46	42	38	34	63	54	49	43	40	37	67	60	53	45	43	42	69	63	56	47	45	46	71	64	59	49	48	49					
		1200	566	0.10																																				

Performance Data • NC Level Application Guide

Model Series 35N • Parallel Flow • Fan Only • Heating Cycle
Fiberglass Liner

PSC Motor

Unit Size	Inlet Size	Airflow		Discharge ΔPs		NC Level	
		cfm	l/s	"w.g.	Pa	Discharge	Radiated
2	ALL	600	283	0.25	62	25	41
		500	236	0.25	62	20	35
		400	189	0.25	62	-	33
		300	142	0.25	62	-	32
3	ALL	1000	472	0.25	62	20	39
		850	401	0.25	62	-	36
		700	330	0.25	62	-	34
		550	260	0.25	62	-	33
5	ALL	1850	873	0.25	62	25	46
		1600	755	0.25	62	24	45
		1400	661	0.25	62	21	44
		1200	566	0.25	62	-	40
		1000	472	0.25	62	-	38
		800	378	0.25	62	-	34
6	ALL	2100	991	0.25	62	27	46
		1900	897	0.25	62	28	48
		1700	802	0.25	62	25	45
		1500	708	0.25	62	22	44
		1200	566	0.25	62	-	40

Performance Notes:

1. NC Levels are calculated based on procedures as outlined on page C160.
2. Dash (-) in space indicates a NC less than 20.

Performance Data • Sound Power Levels

Model Series 35N • Parallel Flow • Fan Only • Heating Cycle
Fiberglass Liner

Unit Size	Inlet Size	Airflow		Discharge ΔPs		Sound Power Octave Bands													
		cfm	l/s	"w.g.	Pa	Discharge							Radiated						
						2	3	4	5	6	7	2	3	4	5	6	7		
2	ALL	600	283	0.25	62	71	63	61	58	54	53	75	67	62	58	53	51		
		500	236	0.25	62	67	60	59	56	53	52	68	62	60	55	49	47		
		400	189	0.25	62	62	55	54	50	47	46	67	60	58	52	45	43		
		300	142	0.25	62	60	52	52	47	44	41	63	57	57	50	43	38		
3	ALL	1000	472	0.25	62	69	61	60	59	57	54	73	66	63	61	56	53		
		850	401	0.25	62	64	58	59	57	54	52	70	64	61	58	53	50		
		700	330	0.25	62	62	56	56	53	50	47	67	61	59	55	49	45		
		550	260	0.25	62	61	53	53	50	46	42	65	59	58	52	45	41		
5	ALL	1850	873	0.25	62	72	67	66	65	62	61	79	71	66	63	60	58		
		1600	755	0.25	62	72	66	64	63	60	59	78	70	64	61	58	56		
		1400	661	0.25	62	70	64	62	60	57	56	77	68	62	59	55	53		
		1200	566	0.25	62	68	60	59	56	54	52	74	65	60	56	52	49		
		1000	472	0.25	62	67	58	57	54	51	49	72	63	58	54	49	46		
		800	378	0.25	62	64	55	54	51	47	44	69	60	56	51	45	41		
6	ALL	2100	991	0.25	62	72	68	68	67	64	63	79	71	68	66	63	61		
		1900	897	0.25	62	72	69	67	67	64	63	80	71	66	65	62	60		
		1700	802	0.25	62	69	67	65	64	61	61	78	69	65	63	60	58		
		1500	708	0.25	62	67	64	63	62	59	58	77	67	63	61	58	55		
		1200	566	0.25	62	64	62	61	59	55	54	74	65	61	58	55	51		



For performance table notes, see page C142; highlighted numbers indicate embedded AHRI certification points.

Performance Data • AHRI Certification and Performance Notes

Model Series 35N • Parallel Flow • AHRI Certification Rating Points

Fiberglass Liner

Unit Size	Inlet Size	Primary Airflow		Min. Inlet ΔPs		100% Primary @ 1.5" w.g. (375 Pa) ΔPs w/ .25" w.g. (62 Pa) Discharge ΔPs														Fan Airflow		Fan† Watts	Fan Only* @ 25" w.g. (62 Pa) ΔPs													
						Discharge							Radiated										Discharge							Radiated						
						cfm	l/s	"w.g.	Pa	2	3	4	5	6	7	2	3	4	5				6	7	cfm	l/s	2	3	4	5	6	7	2	3	4	5
2	6	400	189	0.15	37	72	70	63	56	54	57	66	62	58	48	42	40	600	283	254	71	63	61	58	54	53	75	67	62	58	53	51				
3	10	1100	519	0.16	40	71	72	65	57	59	62	67	63	57	48	43	41	1000	472	385	69	61	60	59	57	54	73	66	63	61	56	53				
5	12	1600	755	0.15	37	71	71	65	56	57	60	69	63	56	47	45	46	1850	873	995	72	67	66	65	62	61	79	71	66	63	60	58				
6	14	2100	991	0.14	35	75	72	66	59	61	65	71	65	60	51	48	49	2100	991	814	72	68	68	67	64	63	79	71	68	66	63	61				

† Motor = PSC.

*Primary air valve is closed and therefore primary cfm is zero.



Ratings are certified in accordance with AHRI Standards.

Performance Notes for Sound Power Levels:

- Discharge sound power is the noise emitted from the unit discharge into the downstream duct. Discharge Sound Power Levels (SWL) now include duct end reflection energy as part of the standard rating. Including the duct end correction provides sound power levels that would normally be transmitted into an acoustically, non-reflective duct. The effect of including the energy correction to the discharge SWL, is higher sound power levels when compared to previous AHRI certified data. For more information on duct end reflection calculations see AHRI Standard 880.
- Radiated sound power is the breakout noise transmitted through the unit casing walls.
- Sound power levels are in decibels, dB re 10⁻¹² watts.
- All sound data listed by octave bands is raw data without any corrections for room absorption or duct attenuation. Dash (-) in space indicates sound power level is less than 20 dB or equal to background.
- Minimum inlet ΔPs is the minimum operating pressure requirement of the unit (damper full open) to achieve rated primary CFM.
- Asterisk (*) in space indicates that the minimum inlet static pressure requirement is greater than 0.5" w.g. (125 Pa) at rated airflow.
- Data derived from independent tests conducted in accordance with ANSI/ASHRAE Standard 130 and AHRI Standard 880.
- 100% primary air sound power levels are cooling cycle (fan turned off).
- Fan airflow is rated fan volume at .25" w.g. (62 Pa) downstream static pressure.
- Fan only sound power levels are 100% recirculated air; fan only; in heating cycle.
- Fan Watts are the maximum electrical power input at rated fan volume.

Performance Data • Hot Water Coil

Model: 35NW • Parallel Flow

Unit Size 2

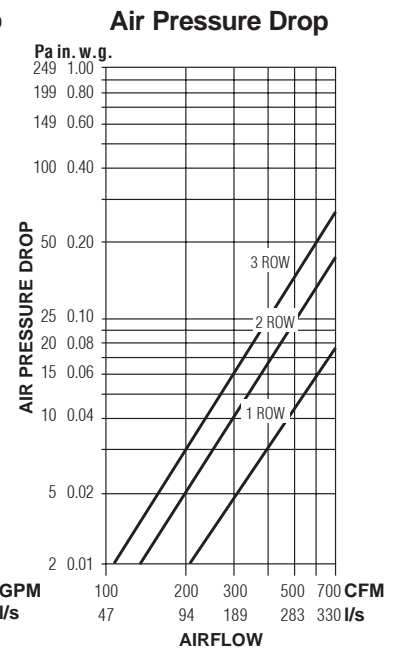
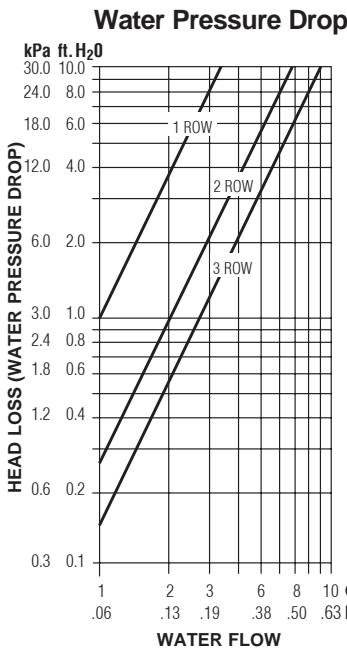
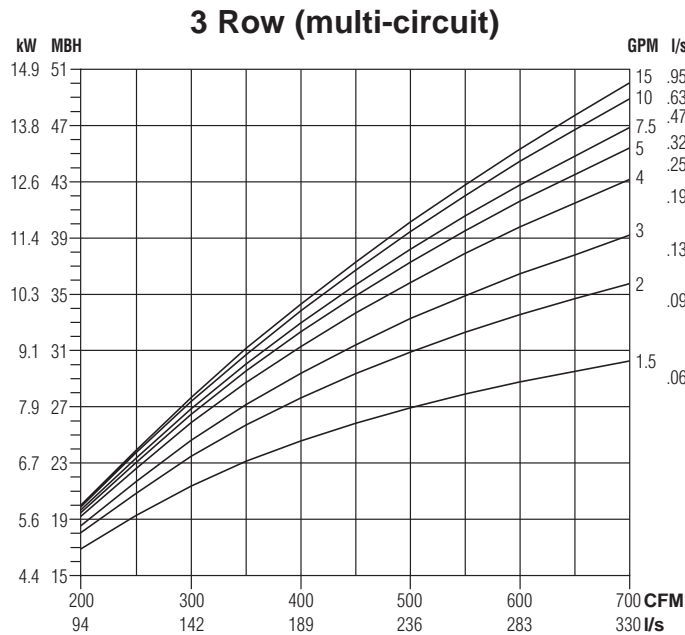
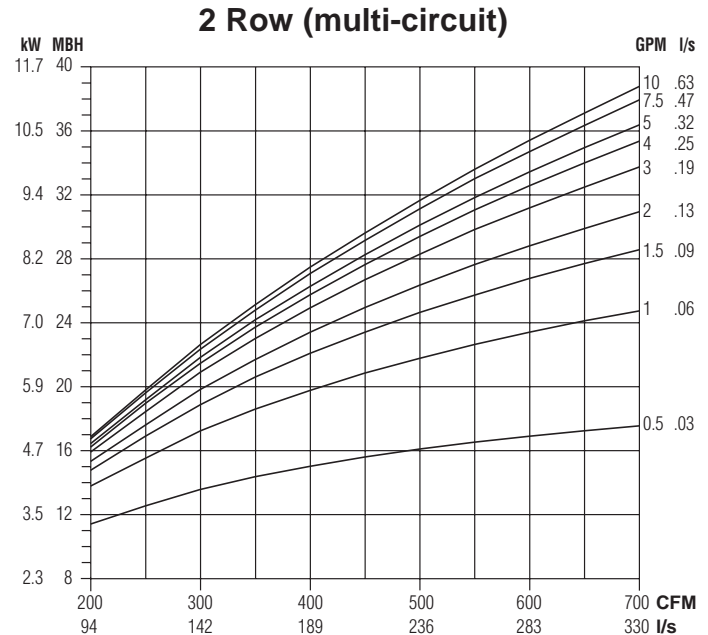
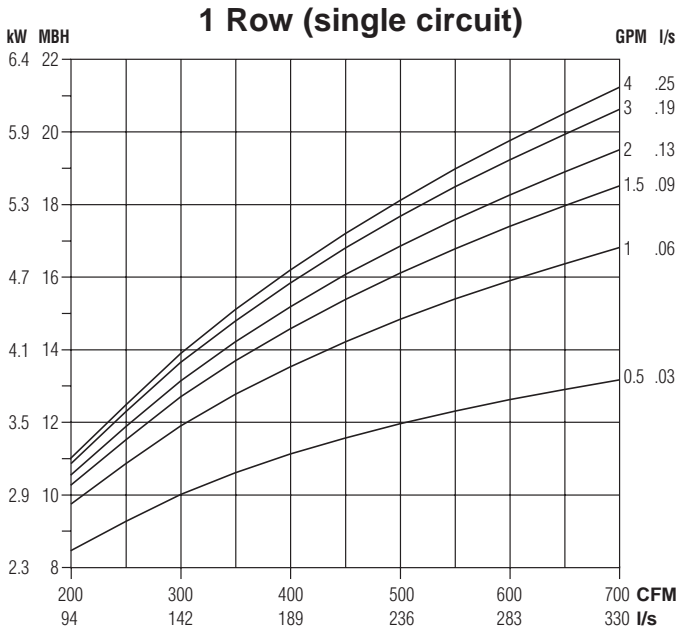

NOTES:

- Capacities are in MBH (kW), **thousands of Btu per hour (kiloWatts)**.
- MBH (kW) values are based on a Δt (temperature difference) of 110°F (61°C) between entering air and entering water. For other Δt's; multiply the MBH (kW) values by the factors below.

- Air Temperature Rise.

$$\text{ATR (}^\circ\text{F)} = 927 \times \frac{\text{MBH}}{\text{cfm}}, \quad \text{ATR (}^\circ\text{C)} = 829 \times \frac{\text{kW}}{\text{I/s}}$$

- Water Temp. Drop.

$$\text{WTD (}^\circ\text{F)} = 2.04 \times \frac{\text{MBH}}{\text{GPM}}, \quad \text{WTD (}^\circ\text{C)} = .224 \times \frac{\text{kW}}{\text{I/s}}$$

- Connections: 1 Row 1/2" (13), 2 and 3 Row 7/8" (22); O.D. male solder.

Altitude Correction Factors:

Altitude ft. (m)	Sensible Heat Factor
0 (0)	1.00
2000 (610)	0.94
3000 (914)	0.90
4000 (1219)	0.87
5000 (1524)	0.84
6000 (1829)	0.81
7000 (2134)	0.78

Correction factors at other entering conditions:

Δt °F (°C)	50 (28)	60 (33)	70 (39)	80 (44)	90 (50)	100 (56)	110 (61)	120 (67)	130 (72)	140 (78)	150 (83)
Factor	.455 (.459)	.545 (.541)	.636 (.639)	.727 (.721)	.818 (.820)	.909 (.918)	1.00 (1.00)	1.09 (1.10)	1.18 (1.18)	1.27 (1.28)	1.36 (1.36)

Performance Data • Hot Water Coil

Model: 35NW • Parallel Flow

Unit Size 3

1 Row (single circuit)

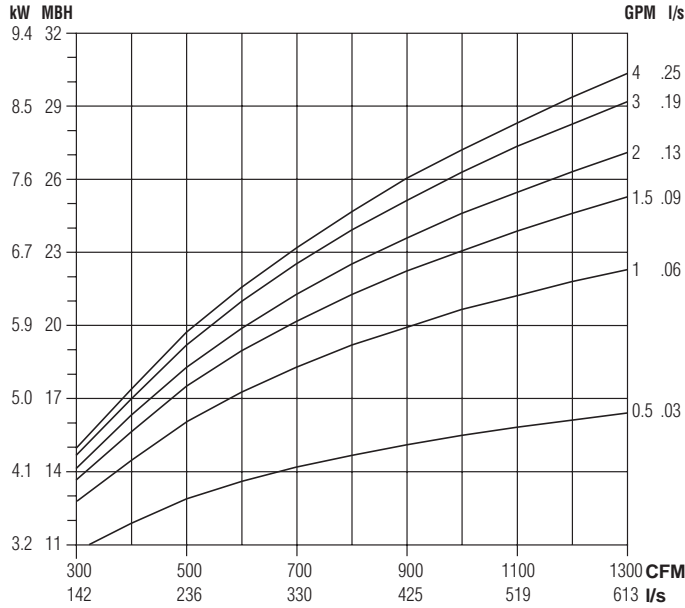

2 Row (multi-circuit)

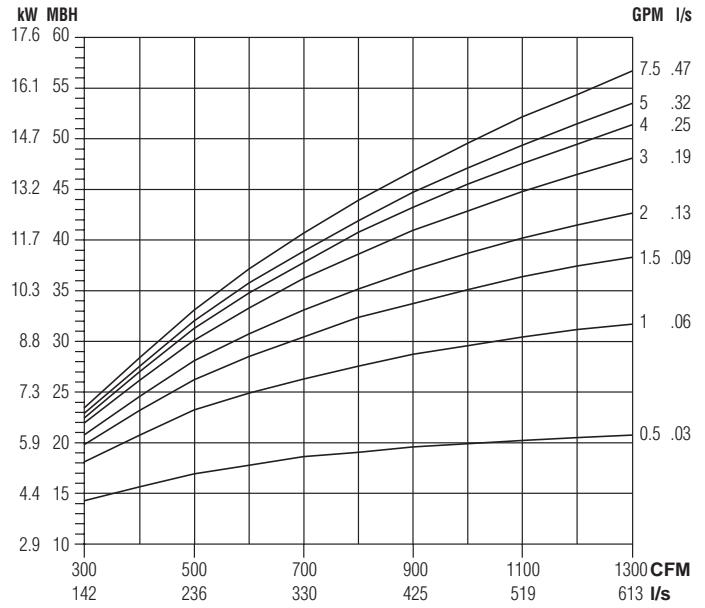

3 Row (multi-circuit)

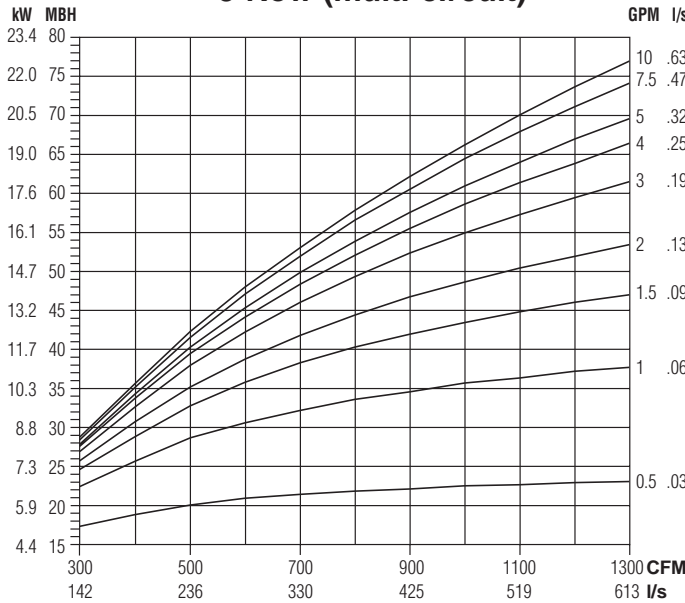

Water Pressure Drop

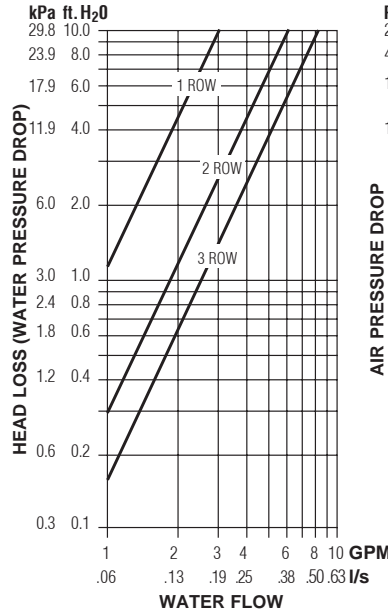

Air Pressure Drop

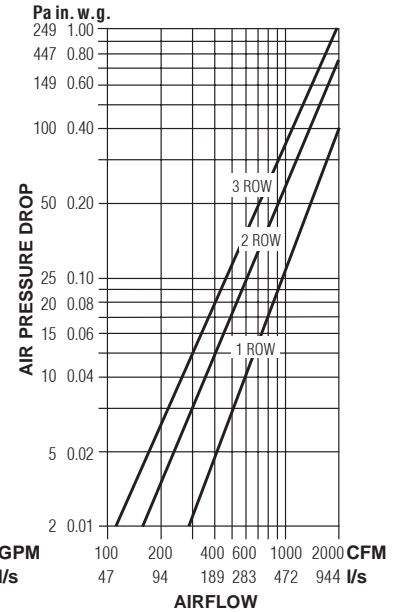

NOTES:

1. Capacities are in MBH (kW), *thousands of Btu per hour (kiloWatts)*.

2. MBH (kW) values are based on a Δt (temperature difference) of 110°F (61°C) between entering air and entering water. For other Δt's; multiply the MBH (kW) values by the factors below.

3. Air Temperature Rise.

$$\text{ATR (°F)} = 927 \times \frac{\text{MBH}}{\text{cfm}}, \quad \text{ATR (°C)} = 829 \times \frac{\text{kW}}{\text{l/s}}$$

4. Water Temp. Drop.

$$\text{WTD (°F)} = 2.04 \times \frac{\text{MBH}}{\text{GPM}}, \quad \text{WTD (°C)} = .224 \times \frac{\text{kW}}{\text{l/s}}$$

5. Connections: 1 Row 1/2" (13), 2 and 3 Row 7/8" (22); O.D. male solder.

Altitude Correction Factors:

Altitude ft. (m)	Sensible Heat Factor
0 (0)	1.00
2000 (610)	0.94
3000 (914)	0.90
4000 (1219)	0.87
5000 (1524)	0.84
6000 (1829)	0.81
7000 (2134)	0.78

Correction factors at other entering conditions:

Δt °F (°C)	50 (28)	60 (33)	70 (39)	80 (44)	90 (50)	100 (56)	110 (61)	120 (67)	130 (72)	140 (78)	150 (83)
Factor	.455 (.459)	.545 (.541)	.636 (.639)	.727 (.721)	.818 (.820)	.909 (.918)	1.00 (1.00)	1.09 (1.10)	1.18 (1.18)	1.27 (1.28)	1.36 (1.36)

Performance Data • Hot Water Coil

Model: 35NW • Parallel Flow

Unit Size 5

1 Row (multi-circuit)

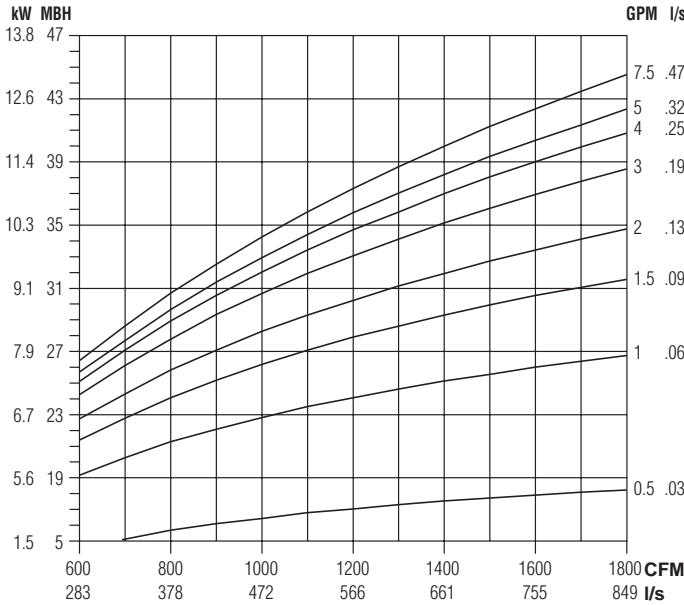

2 Row (multi-circuit)

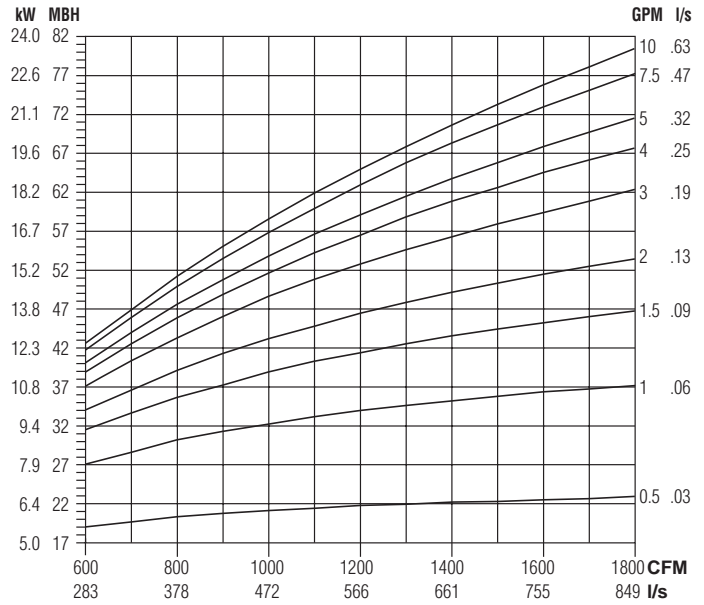

3 Row (multi-circuit)

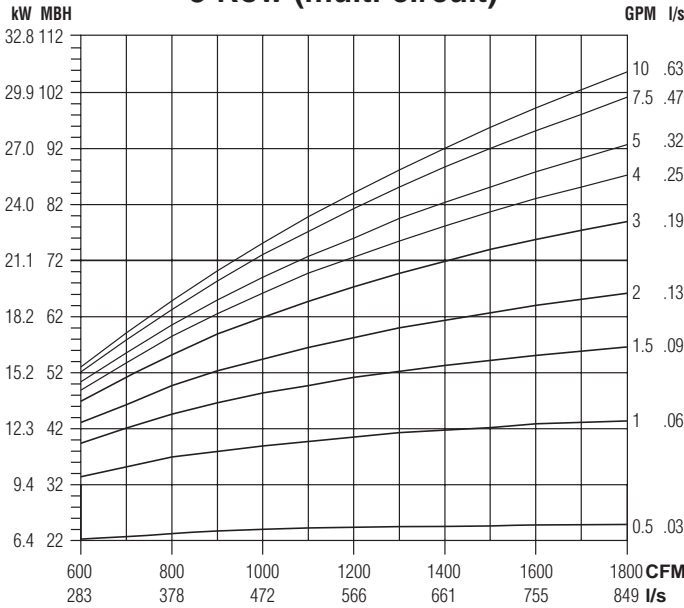

Water Pressure Drop

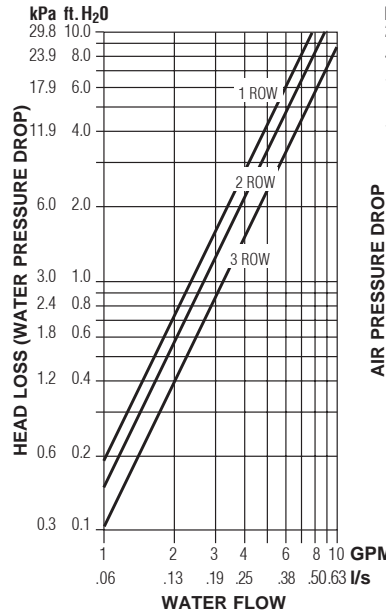

Air Pressure Drop

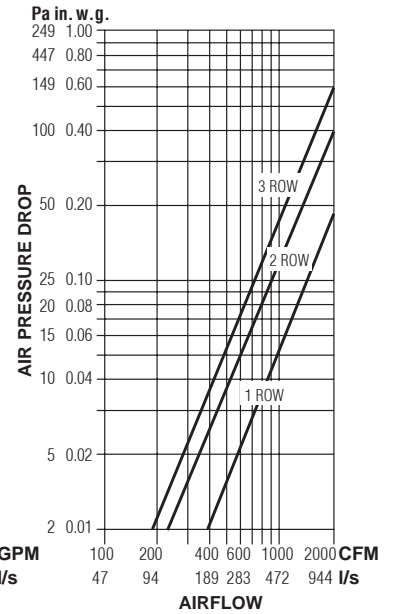

NOTES:

- Capacities are in MBH (kW), **thousands of Btu per hour (kiloWatts)**.
- MBH (kW) values are based on a Δt (temperature difference) of 110°F (61°C) between entering air and entering water. For other Δt 's; multiply the MBH (kW) values by the factors below.

- Air Temperature Rise.

$$\text{ATR (}^\circ\text{F)} = 927 \times \frac{\text{MBH}}{\text{cfm}}, \text{ ATR (}^\circ\text{C)} = 829 \times \frac{\text{kW}}{\text{I/s}}$$

- Water Temp. Drop.

$$\text{WTD (}^\circ\text{F)} = 2.04 \times \frac{\text{MBH}}{\text{GPM}}, \text{ WTD (}^\circ\text{C)} = .224 \times \frac{\text{kW}}{\text{I/s}}$$

- Connections: 1, 2 and 3 Row 7/8" (22); O.D. male solder.

Altitude Correction Factors:

Altitude ft. (m)	Sensible Heat Factor
0 (0)	1.00
2000 (610)	0.94
3000 (914)	0.90
4000 (1219)	0.87
5000 (1524)	0.84
6000 (1829)	0.81
7000 (2134)	0.78

Correction factors at other entering conditions:

Δt °F (°C)	50 (28)	60 (33)	70 (39)	80 (44)	90 (50)	100 (56)	110 (61)	120 (67)	130 (72)	140 (78)	150 (83)
Factor	.455 (.459)	.545 (.541)	.636 (.639)	.727 (.721)	.818 (.820)	.909 (.918)	1.00 (1.00)	1.09 (1.10)	1.18 (1.18)	1.27 (1.28)	1.36 (1.36)

Performance Data • Hot Water Coil

Model: 35NW • Parallel Flow

Unit Size 6

1 Row (multi-circuit)

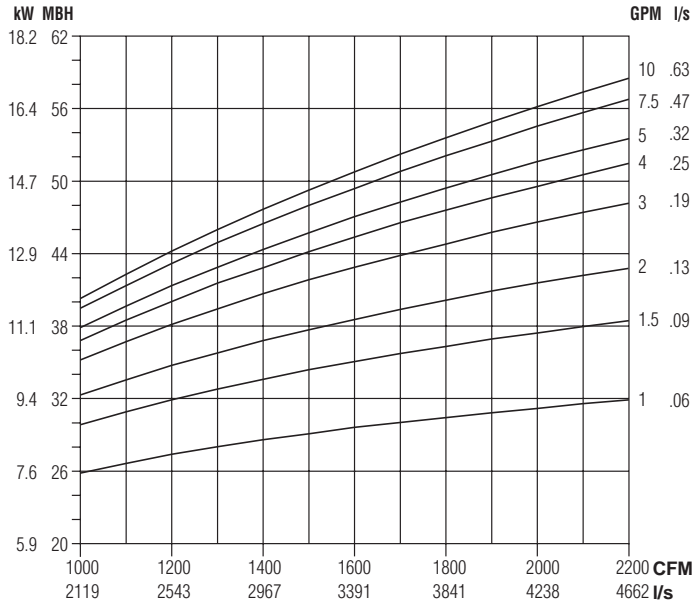

2 Row (multi-circuit)

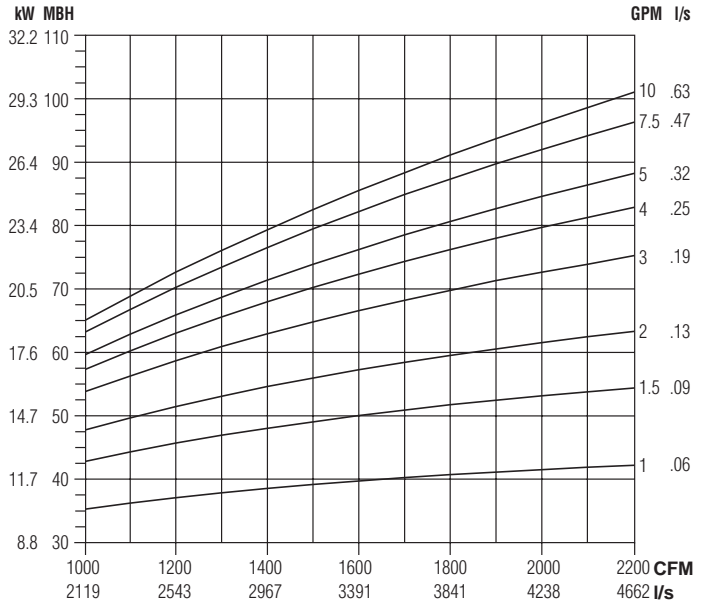

3 Row (multi-circuit)

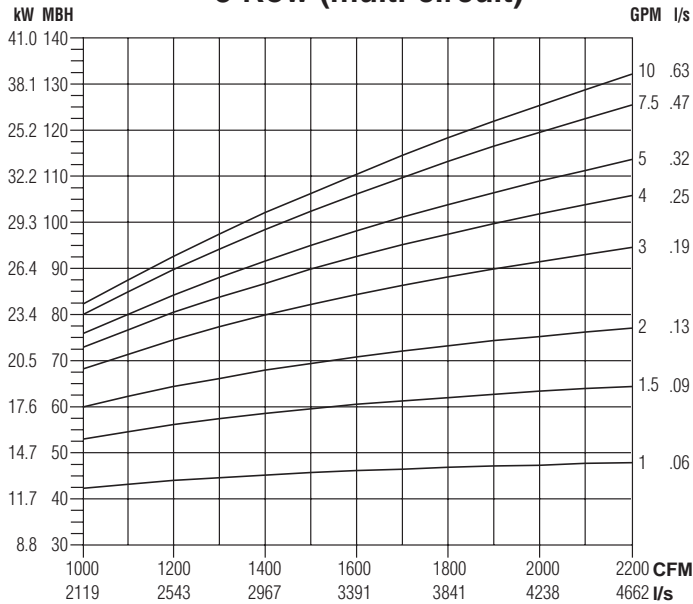

Water Pressure Drop

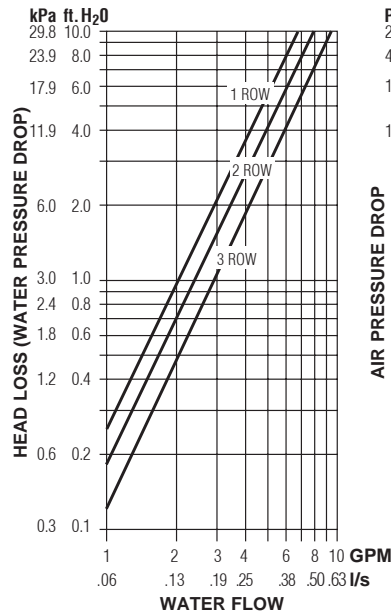

Air Pressure Drop

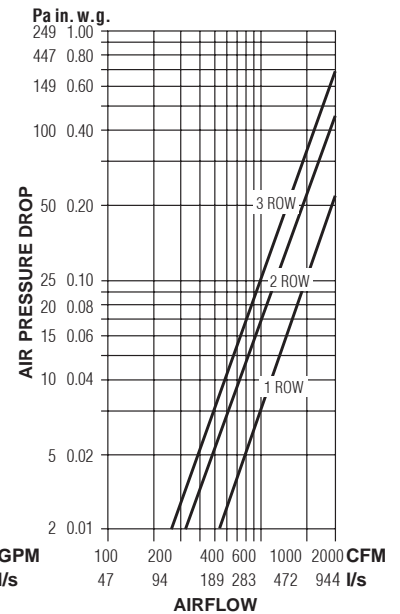

NOTES:

- Capacities are in MBH (kW), *thousands of Btu per hour (kiloWatts)*.
- MBH (kW) values are based on a Δt (temperature difference) of 110°F (61°C) between entering air and entering water. For other Δt 's; multiply the MBH (kW) values by the factors below.

- Air Temperature Rise.

$$\text{ATR (°F)} = 927 \times \frac{\text{MBH}}{\text{cfm}}, \quad \text{ATR (°C)} = 829 \times \frac{\text{kW}}{\text{l/s}}$$

- Water Temp. Drop.

$$\text{WTD (°F)} = 2.04 \times \frac{\text{MBH}}{\text{GPM}}, \quad \text{WTD (°C)} = .224 \times \frac{\text{kW}}{\text{l/s}}$$

- Connections: 1, 2 and 3 Row 7/8" (22); O.D. male solder.

Altitude Correction Factors:

Altitude ft. (m)	Sensible Heat Factor
0 (0)	1.00
2000 (610)	0.94
3000 (914)	0.90
4000 (1219)	0.87
5000 (1524)	0.84
6000 (1829)	0.81
7000 (2134)	0.78

Correction factors at other entering conditions:

Δt °F (°C)	50 (28)	60 (33)	70 (39)	80 (44)	90 (50)	100 (56)	110 (61)	120 (67)	130 (72)	140 (78)	150 (83)
Factor	.455 (.459)	.545 (.541)	.636 (.639)	.727 (.721)	.818 (.820)	.909 (.918)	1.00 (1.00)	1.09 (1.10)	1.18 (1.18)	1.27 (1.28)	1.36 (1.36)

**PARALLEL FLOW
VARIABLE VOLUME**

**37N SERIES
• LOW PROFILE**



Model 37NW

Models:

- 37N No Heat**
- 37NE Electric Heat**
- 37NW Hot Water Heat**

The **37N Low Profile Series** provides many standard design features and excellent sound performance when compared with other parallel designs. The 37N offers a compact and economical design that provides excellent performance in the most demanding variable air volume/intermittent fan applications. The fan is mounted at ninety degrees to the primary airflow to provide optimum mixing.

STANDARD FEATURES:

- Only 11" (279) to 12 1/2" (318) high.
- 20 ga. (1.0) galvanized steel construction.
- 2 x 20 ga. (1.0) round or rectangular primary air damper with a polyurethane peripheral gasket. 90° rotation, CW to close. 1/2" (13) dia. plated steel drive shaft. An indicator mark on the end of the shaft shows damper-position. Damper leakage is less than 2% of nominal flow at 3" w.g. (750 Pa).
- Round or rectangular 6" (152) deep inlet collars for field duct connection.
- Multi-point averaging Diamond Flow sensor (pressure independent control only).
- Access panels on underside of terminal for ease of maintenance and service.
- Energy efficient PSC fan motor with thermal overload protection.
- Solid state fan speed controller with minimum voltage stop.
- Motor blower assembly mounted on special 16 ga. (1.61) angles and isolated from casing with rubber isolators.
- Gasketed backdraft damper mounted on fan discharge restricts primary air escaping through the fan section into the ceiling plenum.

- Hinged door on fan controls enclosure.
- 1/2" (13) dual density insulation. Exposed edges coated to prevent air erosion. Meets requirements of NFPA 90A and UL 181.
- Available with electric or hot water supplementary heat.
- Hot water coils are mounted on induced air inlet of 37NW unit and are designed to accept flanged duct connection.
- Electric coils are mounted on unit discharge.
- Single point electrical and/or pneumatic main air connection.
- Discharge opening designed for flanged duct connection.
- Full primary air valve low voltage NEMA 1 type enclosure for factory mounted DDC and analog electronic controls.

Controls:

- Nailor EZvav
- Analog electronic and pneumatic controls. Factory supplied, mounted and calibrated.
- Digital controls. Factory mounting and wiring of DDC controls. Controls supplied by BAS controls contractor.

Options:

- ECM/EPIC Fan Technology®.
- Induced air filter, 1" (25) thick, disposable type.
- Primary air valve enclosure for field mounted controls.
- Toggle disconnect switch. Units with electric heat also offer door Interlocking type.
- Various IAQ linings are available.
- Fan airflow switch for night shutdown.
- Night setback fan/heat cycle (pneumatic and analog).
- Fan unit fusing.
- Hanger brackets.
- Induced air attenuator.



Dimensions

Model Series 37N • Parallel Flow • Low Profile

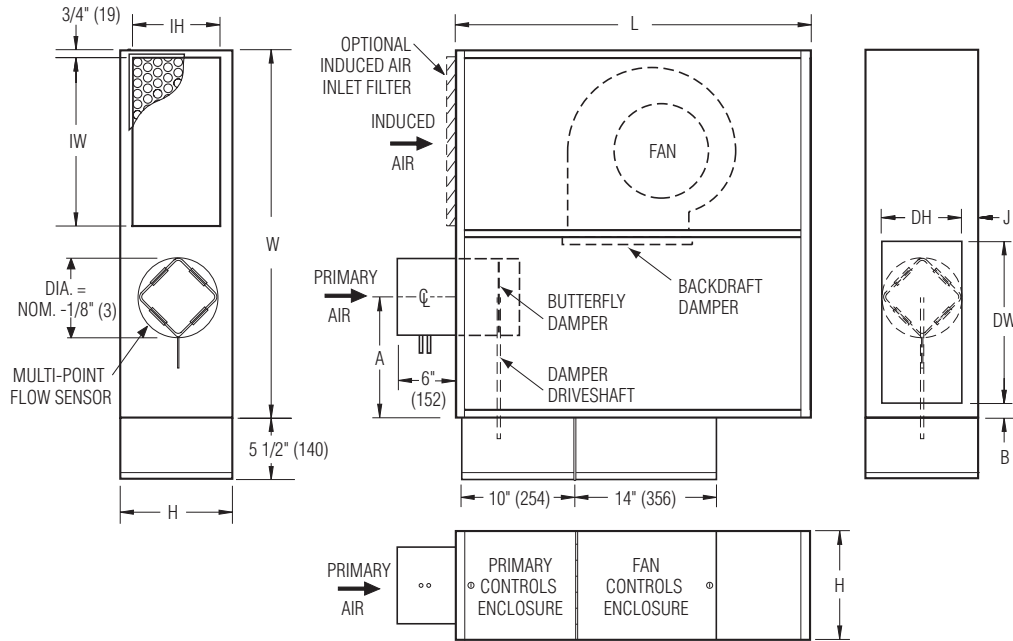

Right hand unit, top view illustrated. Controls mounted as standard on RH side as shown. Left hand terminals ordered with LH controls (optional), are built as mirror image. Inlet, discharge and control enclosure are opposite of the drawing.

Dimensional Data

Unit Size	Inlet Size	W	L	H	A	Induced Air Inlet IW x IH	Outlet Discharge DW x DH	B	J	Filter (Optional) Size
2	6 (152), 8 (203), 10 (254)	32 (813)	36 (914)	11 (279)	7 7/8 (200), 6 1/2 (165)	12 x 10 (305 x 254)	10 x 8 (254 x 203)	1 1/2 (38)	1 1/2 (38)	14 x 11 (356 x 279)
3	8 (203), 10 (254), 14 x 8 (356 x 203)	38 (965)	36 (914)	11 (279)	12 (305), 8 1/8 (206)	16 x 10 (406 x 254)	16 x 8 (406 x 203)	1 1/2 (38)	1 1/2 (38)	18 x 11 (457 x 279)
4*	14 x 8 (356 x 203), 14 x 10 (356 x 254)	43 (1092)	36 (914)	12 1/2 (318)	13 (330)	19 x 10 (483 x 254)	19 x 11 (483 x 279)	1 (25)	3/4 (19)	21 x 11 (533 x 279)

*Unit size 4 with rectangular damper, 90° rotation.

Options and Accessories:

Q option – Induced Air Attenuator

- 22 ga. (0.86) galvanized steel construction.
- Shipped loose for field attachment.
- Flanged connection.
- 1/2" (13) thick dual density fiberglass liner. Meets requirements of NFPA 90A & UL 181.

Without HW Coil

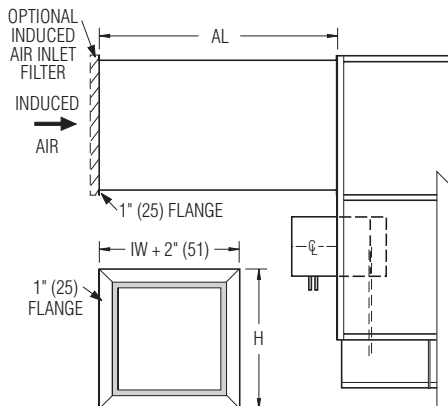

With HW Coil

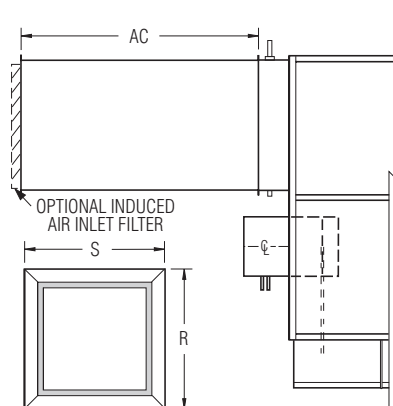

Unit Size	H	IW	S	R	AL	AC
2	11 (279)	12 (305)	13 (330)	11 (279)	36 (914)	36 (914)
3	11 (279)	16 (406)	17 (432)	11 (279)	36 (914)	36 (914)
4	12 1/2 (318)	19 (483)	22 (559)	11 (279)	36 (914)	36 (914)

Dimensions

Model Series 37N • Parallel Flow • Low Profile

Hot Water Coil Section

Model 37NW

Available in one or two row. Coil section mounted on induced air inlet.

Standard Features:

- 1/2" (13) copper tubes.
- Aluminum ripple fins.
- Sweat Connections: 1/2" (13); O. D. male solder.
- 2 Row 7/8" (22); O.D. male solder.

Coil Hand Connections:

(Looking in direction of airflow).

- Left hand (illustrated). Standard.
- Right hand (terminals are inverted. Built as mirror image) Optional.

Connections must be selected opposite hand to controls enclosure location.

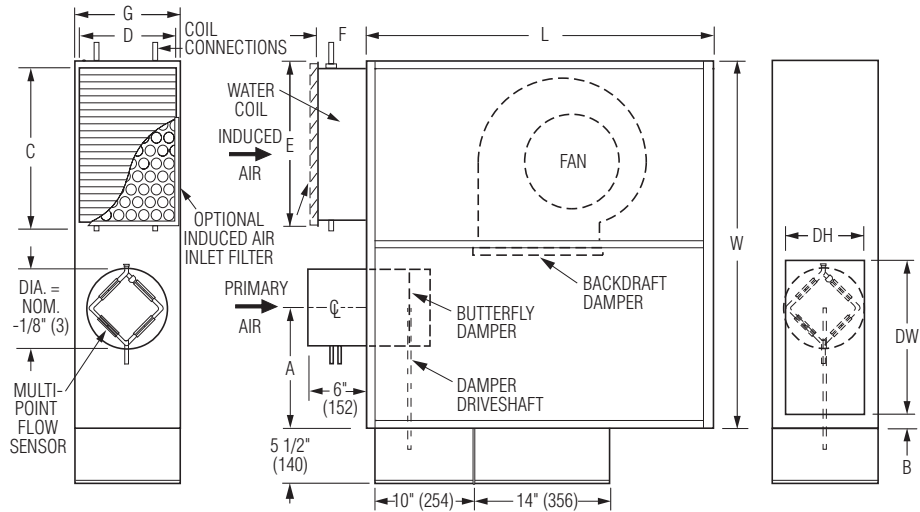

Unit Size	W	L	H	B	C x D	E	F	G	DW x DH
2	32 (813)	36 (914)	11 (279)	1 1/2 (38)	12 x 10 (305 x 254)	13 (330)	5 (127)	11 (279)	10 x 8 (254 x 203)
3	38 (965)	36 (914)	11 (279)	1 1/2 (38)	16 x 10 (406 x 254)	17 (432)	5 (127)	11 (279)	16 x 8 (406 x 203)
4	43 (1092)	36 (914)	12 1/2 (318)	1 (25)	21 x 10 (533 x 254)	22 (559)	5 (127)	11 (279)	19 x 11 (483 x 279)

Electric Coil Section

Model 37NE

Standard Features:

- Unique hinged heater design permits easy access, removal and replacement of heater element without disturbing ductwork.
- Coil installed on unit discharge.
- Insulated coil element wrapper.
- Automatic reset high limit cut-outs (one per element).
- Single point electrical connection (except 600V).
- Magnetic contactors per stage.
- Class A 80/20 Ni/Cr wire.
- Positive pressure airflow switch.
- Flanged outlet duct connection.
- Terminal unit with coil is ETL Listed as an assembly.
- Controls mounted as standard on RH side as shown. Terminals ordered with LH controls (optional) are built as mirror image.

Standard Supply Voltage (60 Hz):

- Single phase: 120, 208, 240 & 277V.
- Three phase: 208, 480 (4 wire wye) and 600V (dual point connection).

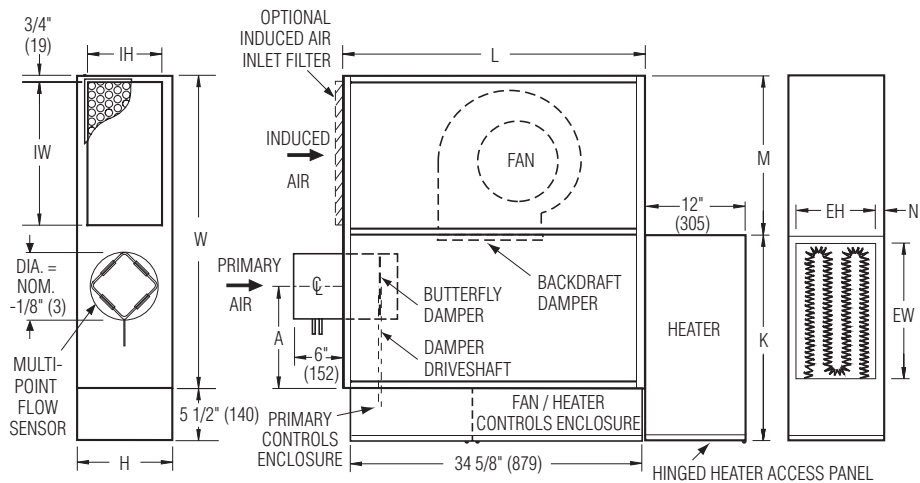

Options:

- Toggle disconnect switch (includes fan).
- Door interlock disconnect switch.
- Power circuit fusing.
- Dust tight construction.
- Manual reset secondary thermal cut out.

Unit Size	W	L	H	IW x IH	K	M	N	EW x EH
2	32 (813)	36 (914)	11 (279)	12 x 10 (305 x 254)	18 1/2 (470)	19 (483)	1 1/2 (38)	10 1/2 x 9 (267 x 229)
3	38 (965)	36 (914)	11 (279)	16 x 10 (406 x 254)	24 1/2 (622)	19 (483)	1 1/2 (38)	16 1/2 x 9 (419 x 229)
4	43 (1092)	36 (914)	12 1/2 (318)	19 x 10 (483 x 254)	27 (686)	22 (559)	3/4 (19)	19 x 10 1/2 (483 x 267)

Performance Data

PSC Motor Fan Curves – Airflow vs. Downstream Static Pressure

37N Series • Parallel Flow • Low Profile

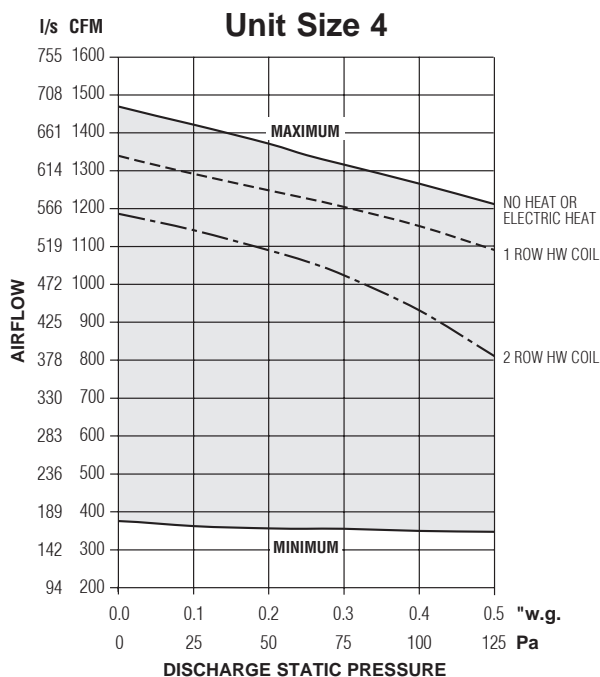
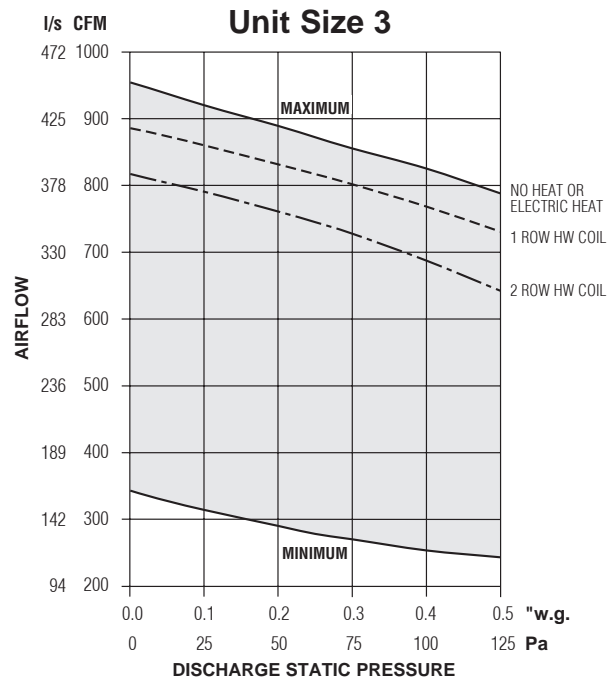
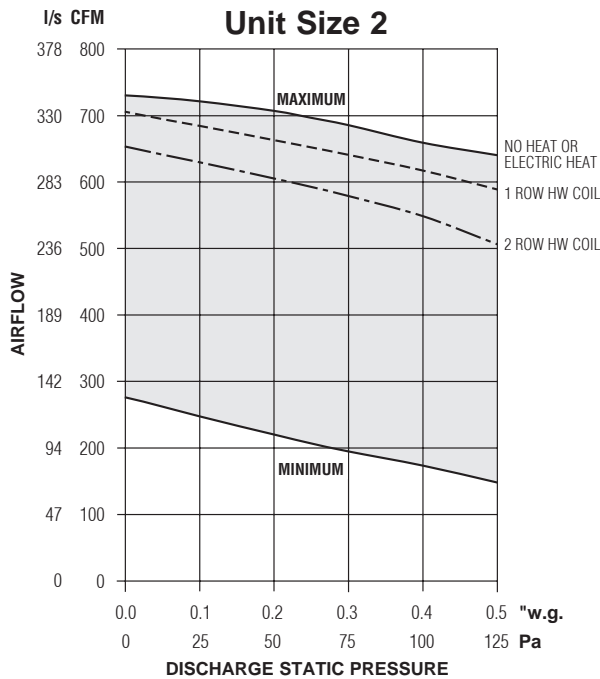

- Fan curves shown are applicable to 120, 208, 240 and 277 volt, single phase PSC motors.

Electrical Data

Unit Size	Motor H.P.	PSC MOTOR FLA			
		120/1/60	208/1/60	240/1/60	277/1/60
2	1/6	4.6	1.8	1.8	1.3
3	1/4	5.4	2.2	2.2	1.7
4	1/2	7.5	3.5	3.5	2.6

FLA = Full load amperage.

Performance Data

ECM Motor Fan Curves – Airflow vs. Downstream Static Pressure

37N Series • Parallel Flow • Low Profile

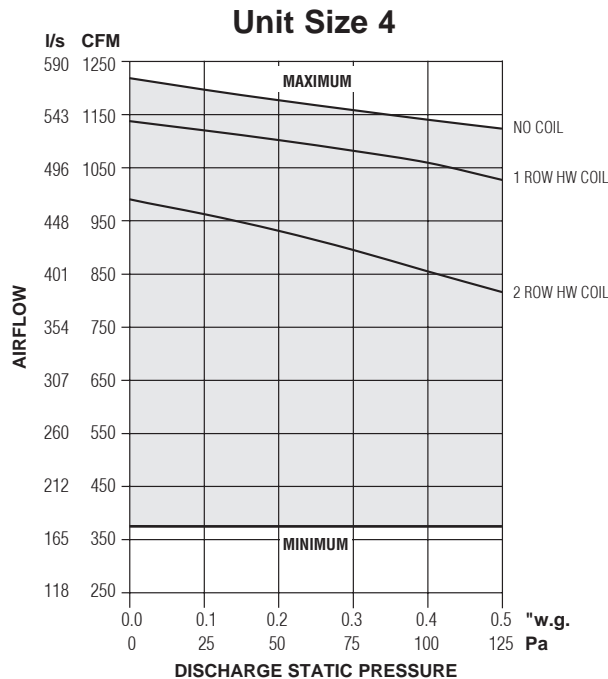
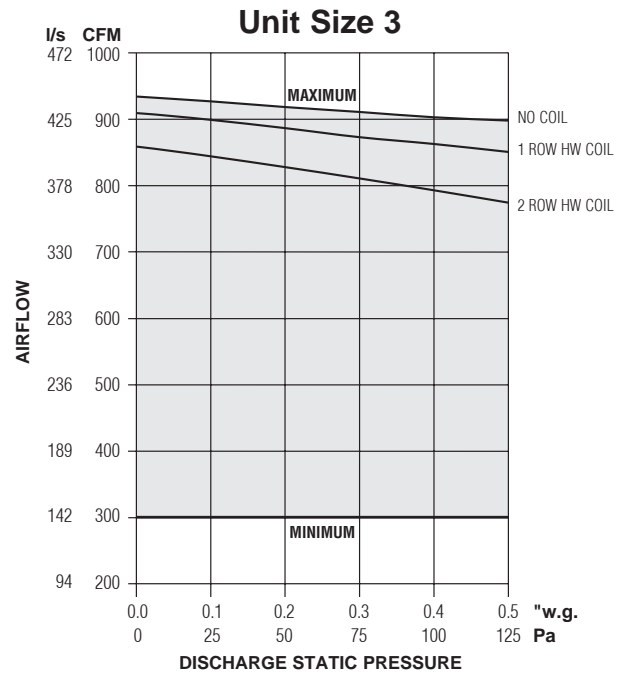
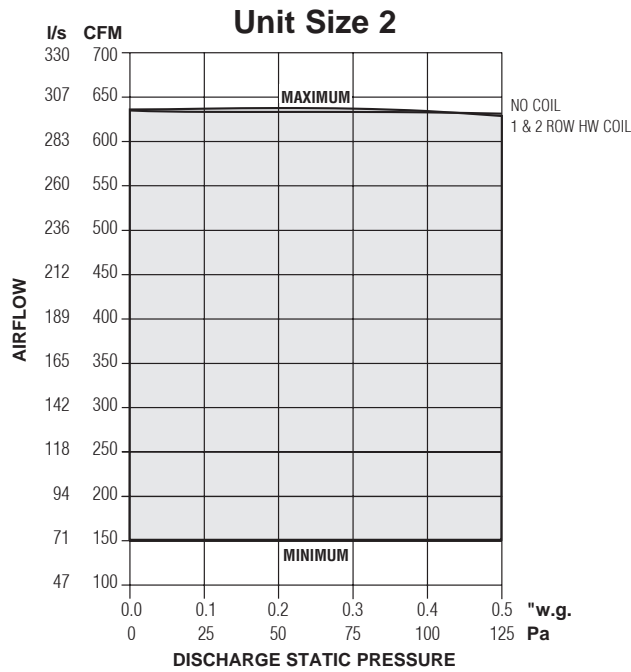

NOTES:

- The ECM is pressure independent and constant volume in operation at factory or field set point within the shaded area. Airflow does not vary with changing static pressure conditions. The motor compensates for any changes in external static pressure or induced air conditions such as filter loading.
- Airflow can be set to operate on horizontal performance line at any point within shaded area using the solid state volume controller provided.
- Fan curves shown are applicable to 120/240, 208 and 277 volt, single phase ECM's. ECM's, although DC in operation, include a built-in AC/DC converter.

Electrical Data

Unit Size	EPIC ECM Motor FLA				
	Motor HP	120V	208V	230V	277V
2	*	2.1	1.5	1.5	1.4
3	*	4.2	2.5	2.6	2.6
4	*	5.1	3.7	3.7	3.8

* The ECM is a variable horsepower motor.
 Refer to Selectworks Schedule for actual power consumption.
 FLA = Full load amperage.
 All motors are single phase/60 Hz.

Performance Data • NC Level Application Guide

Model Series 37N • Parallel Flow • 100% Primary Air • Cooling Cycle

Fiberglass Liner

Unit Size	Inlet Size	Airflow		Min. inlet ΔPs		NC Levels @ Inlet pressure (ΔPs) shown									
						DISCHARGE					RADIATED				
						Min. ΔPs	0.5" w.g. (125 Pa)	1.0" w.g. (250 Pa)	1.5" w.g. (375 Pa)	2.0" w.g. (500 Pa)	Min. ΔPs	0.5" w.g. (125 Pa)	1.0" w.g. (250 Pa)	1.5" w.g. (375 Pa)	2.0" w.g. (500 Pa)
2	6	450	212	0.19	47	-	-	26	31	35	-	25	31	35	36
		400	189	0.16	40	-	-	25	30	34	-	23	31	34	35
		300	142	0.10	25	-	-	21	28	30	-	21	28	30	31
		200	94	0.05	12	-	-	-	24	26	-	-	23	24	26
		100	47	0.02	5	-	-	-	-	-	-	-	-	-	-
	8	800	378	0.11	27	-	-	25	30	33	-	29	38	40	39
		700	330	0.08	20	-	-	24	29	31	-	29	36	38	39
		600	283	0.06	15	-	-	23	26	29	-	26	34	35	35
		400	189	0.03	7	-	-	-	20	20	-	21	26	26	26
		175	83	0.01	2	-	-	-	-	-	-	-	21	21	23
	10	1400	661	0.27	67	20	25	31	35	37	28	29	36	41	43
		1100	519	0.16	40	-	21	28	31	34	-	28	34	39	40
		825	389	0.09	22	-	-	24	29	31	-	24	33	35	36
		550	260	0.04	10	-	-	20	24	25	-	21	28	29	31
		275	130	0.01	2	-	-	-	-	-	-	-	20	24	25
3	8	800	378	0.14	35	-	21	25	29	31	-	28	34	36	38
		700	330	0.10	25	-	21	26	29	30	-	24	31	34	35
		600	283	0.07	17	-	-	24	26	29	-	21	29	31	33
		400	189	0.03	7	-	-	-	-	21	-	-	21	23	25
		175	83	0.01	2	-	-	-	-	-	-	-	-	21	24
	10	1400	661	0.30	75	23	26	31	36	38	28	33	38	41	44
		1100	519	0.17	42	-	23	28	33	35	20	29	34	38	40
		825	389	0.09	22	-	-	25	29	30	-	25	30	34	35
		550	260	0.04	10	-	-	23	24	25	-	20	25	28	29
		275	130	0.01	2	-	-	-	-	20	-	-	-	22	24
	14 x 8	2100	991	0.30	75	20	24	33	37	41	26	33	38	43	45
		1600	755	0.17	42	-	20	29	33	34	21	30	36	40	41
		1200	566	0.10	25	-	-	23	28	29	-	28	33	35	38
		800	378	0.04	10	-	-	-	21	24	-	-	26	29	30
		400	189	0.01	2	-	-	-	21	20	-	-	20	26	29
4	14 x 8	2100	991	0.08	20	20	29	33	38	39	24	34	38	41	44
		1600	755	0.04	10	-	23	28	33	34	-	30	35	40	43
		1200	566	0.02	5	-	-	23	28	29	-	24	30	34	35
		800	378	0.01	2	-	-	-	21	24	-	-	25	26	28
		400	189	0.01	2	-	-	-	21	21	-	-	-	26	29
	14 x 10	2700	1274	0.10	25	20	28	34	38	40	26	34	40	45	49
		1950	920	0.05	12	-	23	29	34	35	-	30	36	43	45
		1550	731	0.03	7	-	20	26	31	33	-	26	34	39	41
		1050	495	0.01	2	-	-	21	25	28	-	21	29	34	36
		525	248	0.01	2	-	-	-	-	20	-	-	-	24	26

Performance Notes:

1. NC Levels are calculated based on procedures as outlined on page C160.
2. Dash (-) in space indicates a NC less than 20.

Performance Data • Discharge Sound Power Levels
 Model Series 37N • Parallel Flow • 100% Primary Air • Cooling Cycle
 Fiberglass Liner



Unit Size	Inlet Size	Airflow		Min. inlet ΔPs		Fan and 100% Primary Air – Sound Power Octave Bands @ Inlet pressure (ΔPs) shown																																		
						Minimum ΔPs						0.5" w.g. (125Pa) ΔPs						1.0" w.g. (249Pa) ΔPs						1.5" w.g. (375Pa) ΔPs						2.0" w.g. (500Pa) ΔPs										
						2	3	4	5	6	7	2	3	4	5	6	7	2	3	4	5	6	7	2	3	4	5	6	7	2	3	4	5	6	7					
2	6	450	212	0.19	47	60	55	51	44	34	32	64	60	57	49	37	36	70	67	62	55	41	40	75	71	66	58	44	44	76	74	68	58	45	46					
		400	189	0.16	40	63	53	49	41	31	29	64	59	56	47	35	33	70	66	61	53	39	38	74	70	65	56	42	42	75	73	67	57	44	45					
		300	142	0.10	25	56	47	43	35	26	21	62	57	53	44	31	29	68	63	58	49	36	36	71	68	62	52	40	41	71	70	65	54	42	44					
		200	94	0.05	12	-	40	35	25	-	-	59	53	49	40	26	25	63	60	55	45	33	35	64	64	59	48	38	41	65	66	62	50	40	44					
		100	47	0.02	5	-	-	24	-	-	-	-	50	45	37	24	24	55	56	51	40	31	35	56	59	57	45	36	39	58	60	59	48	39	41					
	8	800	378	0.11	27	58	53	47	41	33	28	67	62	55	51	40	35	71	67	60	55	43	39	73	71	65	58	45	42	75	73	67	60	47	44					
		700	330	0.08	20	56	50	44	38	30	24	64	60	53	49	38	32	70	65	59	53	41	36	72	69	62	56	43	40	73	71	65	58	45	42					
		600	283	0.06	15	-	47	41	35	27	21	62	58	51	47	35	29	68	64	57	51	38	34	70	67	61	54	41	39	71	69	63	56	43	42					
		400	189	0.03	7	-	42	37	30	25	-	59	55	48	43	30	24	63	59	54	47	34	33	64	62	57	50	36	39	64	62	58	52	37	40					
		175	83	0.01	2	-	-	26	-	-	-	-	47	43	35	28	23	55	52	50	41	25	34	55	54	56	48	31	30	55	55	59	52	34	33					
	10	1400	661	0.27	67	69	63	56	51	48	44	71	67	60	53	49	44	75	72	65	57	52	47	77	75	69	60	54	49	79	77	71	62	55	50					
		1100	519	0.16	40	63	58	51	46	42	36	69	64	57	50	45	39	73	69	62	54	48	42	75	72	66	57	50	45	76	74	69	60	52	47					
		825	389	0.09	22	-	52	46	41	35	27	65	61	53	46	40	33	70	66	59	51	44	37	72	70	64	55	48	43	74	72	66	57	49	44					
		550	260	0.04	10	-	46	40	34	27	-	62	57	49	42	34	27	65	62	56	47	40	36	67	65	59	50	42	37	69	66	60	52	43	39					
		275	130	0.01	2	-	40	35	29	24	-	58	51	45	37	29	27	59	55	50	40	31	27	61	57	53	44	34	31	62	59	55	47	37	34					
3	8	800	378	0.14	35	63	56	49	43	37	31	70	63	55	50	40	35	73	67	60	54	43	39	76	70	64	57	46	42	77	72	65	59	47	44					
		700	330	0.10	25	61	53	46	40	33	27	68	60	53	48	38	32	72	65	59	52	41	37	74	68	62	55	44	40	75	70	64	57	46	43					
		600	283	0.07	17	57	49	43	38	30	23	65	58	52	47	36	30	70	64	58	51	40	37	72	66	61	54	42	39	74	69	63	56	44	41					
		400	189	0.03	7	-	42	37	32	27	-	60	53	48	45	32	25	65	58	54	47	35	35	66	61	57	51	38	36	68	63	59	53	40	37					
		175	83	0.01	2	-	-	-	23	-	-	-	47	43	34	-	-	55	53	53	43	28	25	57	55	57	48	33	31	56	55	59	52	36	35					
	10	1400	661	0.30	75	71	64	58	52	46	41	74	67	61	54	48	42	78	72	66	59	51	46	82	76	70	62	54	48	83	78	73	65	55	50					
		1100	519	0.17	42	65	57	52	46	40	34	71	64	58	51	44	38	75	69	63	55	47	41	79	73	68	60	51	46	81	75	70	63	53	48					
		825	389	0.09	22	58	52	47	41	35	28	68	60	55	48	40	33	73	66	60	53	44	38	76	70	65	57	47	44	77	71	66	59	49	45					
		550	260	0.04	10	-	45	40	35	29	-	63	56	51	45	36	28	69	62	56	49	40	37	70	64	59	51	42	39	71	65	60	52	43	41					
		275	130	0.01	2	-	-	32	30	26	-	56	49	46	38	34	25	60	53	50	41	32	36	62	56	54	45	36	33	64	58	56	48	38	36					
	14 x 8	2100	991	0.30	75	68	63	58	53	47	44	71	66	61	55	48	46	76	73	66	59	52	50	80	77	70	62	55	54	84	81	74	67	61	60					
		1600	755	0.17	42	62	56	51	47	41	35	69	63	58	51	44	41	75	70	63	56	48	48	78	73	66	59	51	51	79	74	68	61	53	53					
		1200	566	0.10	25	55	50	46	41	35	29	67	60	55	49	40	39	71	65	60	53	45	45	73	69	63	56	49	48	74	70	65	57	50	50					
		800	378	0.04	10	-	43	40	35	28	-	60	55	51	45	36	35	64	60	55	49	41	39	67	64	59	51	44	44	68	66	62	54	45	47					
		400	189	0.01	2	-	-	35	32	30	-	-	49	45	39	32	26	57	59	53	44	36	36	58	63	60	49	41	41	58	62	62	51	44	44					
4	14 x 8	2100	991	0.08	20	69	60	56	52	44	43	76	67	63	56	49	48	79	71	67	60	52	52	83	75	71	63	55	55	84	76	72	64	57	57					
		1600	755	0.04	10	61	53	49	44	36	33	71	63	59	52	44	43	75	68	64	56	49	49	79	72	67	59	52	53	80	74	70	61	55	55					
		1200	566	0.02	5	-	46	42	37	29	23	67	59	55	48	40	39	71	64	61	53	46	47	75	68	65	56	50	52	76	70	67	58	51	53					
		800	378	0.01	2	-	40	36	30	25	-	61	54	51	44	36	37	66	60	57	49	43	43	68	64	61	52	46	47	68	66	63	54	47	49					
		400	189	0.01	2	-	-	33	28	24	-	59	50	47	40	33	34	57	59	55	44	38	39	59	63	62	49	42	43	59	63	65	52	45	46					
	14 x 10	2700	1274	0.10	25	69	62	57	53	46	43	75	68	64	57	51	50	80	73	69	61	55	54	83	76	72	64	59	58	85	79	74	66	61	60					
		1950	920	0.05	12	61	53	49	43	36	32	71	64	60	52	46	44	76	69	65	57	52	50	80	73	69	61	56	54	81	75	70	63	58	56					
		1550	731	0.03	7	56	47	43	38	30	23	69	61	58	50	43	41	74	66	62	55	49	47	78	70	66	59	54	52	79	73	69	61	56	55					
		1050	495	0.01	2	-	41	36	30	25	-	65	57	53	46	39	37	70	63	59	52	47	44	73	67	64	55	50	51	75	69	65	57	50	52					
		525	248	0.01	2	-	-	32	29	25	-	58	50	46	40	33	28	61	56	52	44	39	37	63	60	56	48	43	42	64	62	60	51	45	46					

For performance table notes, see page C155; highlighted numbers indicate embedded AHRI certification points.

FAN POWERED TERMINAL UNITS

Performance Data • Radiated Sound Power Levels Model Series 37N • Parallel Flow • 100% Primary Air • Cooling Cycle Fiberglass Liner



Unit Size	Inlet Size	Airflow		Min. inlet ΔPs		Fan and 100% Primary Air – Sound Power Octave Bands @ Inlet pressure (ΔPs) shown																																		
						Minimum ΔPs							0.5" w.g. (125Pa) ΔPs							1.0" w.g. (249Pa) ΔPs							1.5" w.g. (375Pa) ΔPs							2.0" w.g. (500Pa) ΔPs						
						2	3	4	5	6	7	2	3	4	5	6	7	2	3	4	5	6	7	2	3	4	5	6	7	2	3	4	5	6	7					
2	6	450	212	0.19	47	55	48	40	36	32	25	62	53	46	40	35	31	67	59	52	43	36	32	70	63	56	46	38	35	71	65	58	48	39	37					
		400	189	0.16	40	52	45	38	35	31	-	60	51	44	38	33	25	67	58	51	42	35	30	69	62	55	45	37	34	70	64	57	46	38	36					
		300	142	0.10	25	-	-	36	34	32	-	59	49	42	36	33	-	64	55	48	40	35	27	66	58	52	42	35	31	67	61	55	44	37	35					
		200	94	0.05	12	-	-	33	31	29	-	55	46	40	36	34	-	60	52	46	38	35	26	59	54	50	40	36	31	59	55	52	41	35	33					
		100	47	0.02	5	-	-	29	26	-	-	-	40	35	29	-	-	-	44	41	31	26	-	-	45	45	34	29	27	-	46	45	36	31	31					
	8	800	378	0.11	27	56	46	39	37	36	27	65	54	46	42	39	32	72	59	51	44	41	35	74	63	55	45	41	35	73	65	57	47	42	37					
		700	330	0.08	20	56	44	38	36	36	26	65	52	45	40	38	30	71	59	50	43	40	32	72	62	54	44	40	34	73	63	56	45	41	35					
		600	283	0.06	15	52	41	36	34	36	25	63	50	43	38	38	29	69	55	48	40	38	31	70	59	52	42	39	33	70	61	53	44	40	34					
		400	189	0.03	7	50	39	35	33	34	23	59	47	40	36	37	27	63	51	44	37	37	28	63	53	48	39	37	31	63	55	50	41	37	32					
		175	83	0.01	2	-	-	33	30	25	-	49	43	38	32	22	-	52	45	42	33	31	22	53	47	47	37	33	25	54	47	49	40	33	27					
	10	1400	661	0.27	67	64	54	47	43	45	38	65	55	48	43	44	37	71	61	53	45	44	37	75	65	57	47	44	39	76	68	59	48	44	40					
		1100	519	0.16	40	57	49	43	41	42	35	64	54	46	41	42	34	69	59	50	43	42	35	73	64	55	45	42	37	74	66	57	46	42	38					
		825	389	0.09	22	50	44	38	38	41	32	61	52	44	40	41	32	68	57	49	41	40	33	70	60	52	42	39	35	71	62	54	44	39	36					
		550	260	0.04	10	-	42	38	38	39	31	59	50	42	39	40	31	64	53	45	39	38	31	65	56	48	40	38	32	67	58	51	42	39	34					
		275	130	0.01	2	-	41	35	37	37	25	54	46	39	38	38	27	58	49	42	38	37	28	61	52	45	39	37	30	62	54	46	40	38	33					
3	8	800	378	0.14	35	57	48	43	37	31	26	64	53	46	41	34	29	69	57	50	43	37	33	71	60	53	44	39	36	72	63	55	46	41	37					
		700	330	0.10	25	52	46	42	36	29	22	61	51	45	38	31	26	67	55	48	41	35	31	69	59	52	43	37	35	70	61	54	45	39	37					
		600	283	0.07	17	-	44	41	34	28	20	59	49	43	37	30	24	65	54	47	39	33	30	67	57	50	41	36	33	68	59	52	43	38	36					
		400	189	0.03	7	-	41	41	34	27	18	53	46	41	34	28	21	59	50	44	36	30	27	60	52	47	38	32	31	62	53	49	41	34	32					
		175	83	0.01	2	-	41	42	37	30	19	-	44	41	33	28	19	-	46	44	33	27	22	-	47	47	37	30	27	-	47	50	41	32	30					
	10	1400	661	0.30	75	64	54	49	43	40	35	68	58	51	44	41	37	72	63	56	47	42	39	75	68	60	50	44	42	77	69	62	52	46	44					
		1100	519	0.17	42	58	48	46	40	34	27	65	55	49	43	36	32	69	61	54	46	39	35	72	65	58	48	41	39	74	67	60	50	42	40					
		825	389	0.09	22	-	45	44	38	28	18	62	53	48	41	33	26	66	58	51	43	36	31	69	62	54	45	37	36	70	63	56	46	39	38					
		550	260	0.04	10	-	43	43	36	25	-	58	50	45	38	30	21	62	54	47	39	32	29	64	57	50	41	34	33	65	58	51	42	35	35					
		275	130	0.01	2	-	42	42	36	26	-	52	46	43	35	28	19	54	48	45	37	28	22	57	51	48	40	31	26	58	53	50	42	34	30					
	14 x 8	2100	991	0.30	75	63	54	51	46	40	36	68	58	53	48	43	39	72	63	56	51	47	45	76	68	59	53	49	48	78	69	60	55	51	50					
		1600	755	0.17	42	56	50	47	41	34	28	66	55	49	44	39	36	71	60	52	47	44	42	74	63	55	49	47	46	75	65	57	51	49	49					
		1200	566	0.10	25	52	46	44	37	28	17	64	51	45	40	37	36	68	56	49	44	42	41	70	60	52	46	46	45	72	62	55	48	48	48					
		800	378	0.04	10	-	43	43	34	25	-	57	47	42	37	35	35	63	53	46	41	41	41	65	57	49	44	45	45	66	59	53	46	47	47					
		400	189	0.01	2	-	39	42	35	27	-	45	41	35	33	35	35	56	52	46	39	40	40	57	56	52	43	44	44	56	55	54	46	46	47					
4	14 x 8	2100	991	0.08	20	61	53	50	45	40	35	69	59	54	49	44	40	72	62	57	51	47	44	75	65	59	53	49	47	77	67	61	55	52	50					
		1600	755	0.04	10	56	45	44	38	32	26	66	54	49	44	40	36	70	59	53	48	44	41	74	62	56	50	47	46	76	64	58	52	49	49					
		1200	566	0.02	5	50	41	38	32	27	17	61	50	46	41	36	32	66	56	50	45	42	40	69	59	53	47	45	47	70	62	56	49	47	50					
		800	378	0.01	2	-	-	34	27	24	-	56	46	42	37	32	27	62	52	46	40	37	34	63	56	50	44	41	39	64	58	52	46	43	42					
		400	189	0.01	2	-	-	34	27	21	-	49	41	38	32	28	22	53	49	44	36	32	30	55	54	52	42	37	36	54	53	54	45	40	39					
	14 x 10	2700	1274	0.10	25	62	55	52	47	44	36	69	61	56	50	47	42	74	65	60	54	51	48	78	68	62	56	53	50	81	71	64	58	55	55					
		1950	920	0.05	12	54	48	45	39	35	26	66	56	51	45	41	37	71	60	54	48	45	41	76	64	57	51	48	46	78	67	60	53	50	48					
		1550	731	0.03	7	52	44	41	35	31	23	63	53	49	44	40	35	69	58	52	47	45	42	73	62	56	50	48	47	75	65	59	53	51	51					
		1050	495	0.01	2	-	43	37	32	28	18	59	49	45	41	38	35	65	54	49	44	43	44	69	59	53	47	45	47	71	62	56	50	48	49					
		525	248	0.01	2	-	40	36	30	25	-	52	45	40	37	35	32	57	49	44	41	40	39	59	53	50	45	44	43	60	55	52	47	46	46					

For performance table notes, see page C155; highlighted numbers indicate embedded AHRI certification points.

FAN POWERED TERMINAL UNITS

Performance Data • NC Level Application Guide

Model Series 37N • Parallel Flow • Fan Only • Heating Cycle
Fiberglass Liner

PSC Motor

Unit Size	Inlet Size	Airflow		Discharge ΔPs		NC Level	
		cfm	l/s	"w.g.	Pa	Discharge	Radiated
2	ALL	700	330	0.25	62	23	34
		550	259	0.25	62	24	34
		400	189	0.25	62	-	31
		250	118	0.25	62	-	26
3	ALL	850	401	0.25	62	26	38
		700	330	0.25	62	25	35
		550	259	0.25	62	24	32
		350	165	0.25	62	-	28
4	ALL	1350	637	0.25	62	33	45
		1100	519	0.25	62	28	41
		825	389	0.25	62	21	36
		450	212	0.25	62	-	31

Performance Notes:

1. NC Levels are calculated based on procedures as outlined on page C160.
2. Dash (-) in space indicates a NC less than 20.

Performance Data • Sound Power Levels

Model Series 37N • Low Profile • Parallel Flow • Fan Only • Heating Cycle
Fiberglass Liner

PSC Motor

Unit Size	Inlet Size	Airflow		Discharge ΔPs		Sound Power Octave Bands													
		cfm	l/s	"w.g.	Pa	Discharge							Radiated						
						2	3	4	5	6	7	2	3	4	5	6	7		
2	ALL	700	330	0.25	62	68	64	60	55	46	48	67	60	59	54	49	42		
		550	260	0.25	62	70	60	56	51	41	43	69	59	56	50	46	38		
		400	189	0.25	62	61	57	54	47	37	38	63	57	56	48	44	36		
		250	118	0.25	62	-	53	49	41	30	26	59	54	52	43	38	29		
3	ALL	850	401	0.25	62	74	65	63	58	52	55	72	65	63	59	51	43		
		700	330	0.25	62	71	61	60	54	47	50	68	60	60	55	47	38		
		550	260	0.25	62	70	56	56	50	42	45	67	57	57	51	43	33		
		350	165	0.25	62	66	52	51	44	36	35	62	53	53	46	38	26		
4	ALL	1350	637	0.25	62	79	71	70	68	62	63	77	72	69	66	59	51		
		1100	519	0.25	62	75	66	67	62	56	57	73	67	66	62	54	46		
		825	389	0.25	62	70	60	62	56	49	50	69	61	61	56	47	39		
		450	212	0.25	62	63	52	53	46	38	36	64	55	56	49	40	30		



For performance table notes, see page C155; highlighted numbers indicate embedded AHRI certification points.

Performance Data • AHRI Certification and Performance Notes

Model Series 37N • Low Profile • Parallel Flow • AHRI Certification Rating Points

Fiberglass Liner

Unit Size	Inlet Size	Primary Airflow		Min. Inlet ΔPs		100% Primary @ 1.5" w.g. (375 Pa) ΔPs w/ .25" w.g. (62 Pa) Discharge ΔPs														Fan Airflow	Fan† Watts	Fan Only* @ 25" w.g. (62 Pa) ΔPs													
						Discharge							Radiated									Discharge							Radiated						
						2	3	4	5	6	7	2	3	4	5	6	7	2	3			4	5	6	7	2	3	4	5	6	7				
2	10	1100	519	0.16	40	75	72	66	57	50	45	73	64	55	45	42	37	550	260	275	70	60	56	51	41	43	69	59	56	50	46	38			
3	14 x 8	1600	755	0.17	42	78	73	66	59	51	51	74	63	55	49	47	46	700	330	355	71	61	60	54	47	50	68	60	60	55	47	38			
4	14 x 10	1950	920	0.05	12	80	73	69	61	56	54	76	64	57	51	48	46	1100	519	570	75	66	67	62	56	57	73	67	66	62	54	46			

Motor = PSC

* Primary air valve is closed and therefore primary cfm is zero.



Ratings are certified in accordance with AHRI Standards.

Performance Notes for Sound Power Levels:

- Discharge sound power is the noise emitted from the unit discharge into the downstream duct. Discharge Sound Power Levels (SWL) now include duct end reflection energy as part of the standard rating. Including the duct end correction provides sound power levels that would normally be transmitted into an acoustically, non-reflective duct. The effect of including the energy correction to the discharge SWL, is higher sound power levels when compared to previous AHRI certified data. For more information on duct end reflection calculations see AHRI Standard 880.
- Radiated sound power is the breakout noise transmitted through the unit casing walls.
- Sound power levels are in decibels, dB re 10⁻¹² watts.
- All sound data listed by octave bands is raw data without any corrections for room absorption or duct attenuation. Dash (-) in space indicates sound power level is less than 20 dB or equal to background.
- Minimum inlet ΔPs is the minimum operating pressure requirement of the unit (damper full open) to achieve rated primary CFM.
- Asterisk (*) in space indicates that the minimum inlet static pressure requirement is greater than 0.5" w.g. (125 Pa) at rated airflow.
- Data derived from independent tests conducted in accordance with ANSI/ASHRAE Standard 130 and AHRI Standard 880.
- 100% primary air sound power levels are cooling cycle (fan turned off).
- Fan airflow is rated fan volume at .25" w.g. (62 Pa) downstream static pressure.
- Fan only sound power levels are 100% recirculated air; fan only; in heating cycle.
- Fan Watts are the maximum electrical power input at rated fan volume.

Performance Data • Hot Water Coil

Model: 37NW • Parallel Flow • Low Profile

Unit Size 2

1 Row (single circuit)

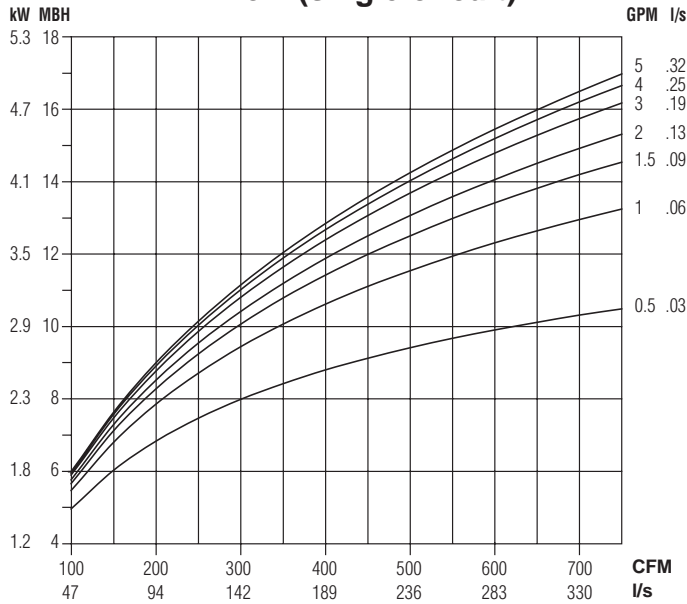

2 Row (multi-circuit)

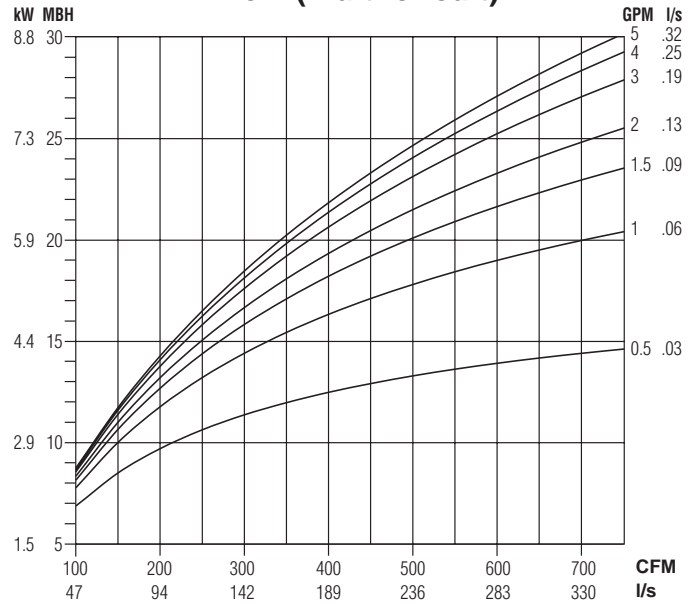

Water Pressure Drop

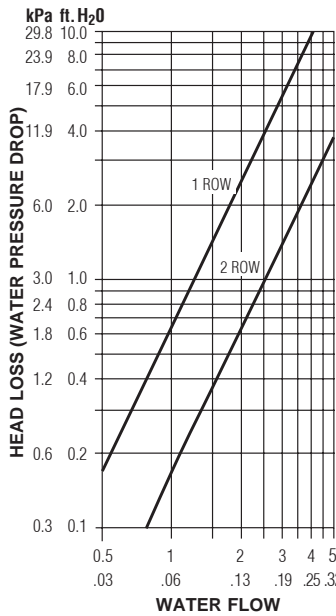

Air Pressure Drop

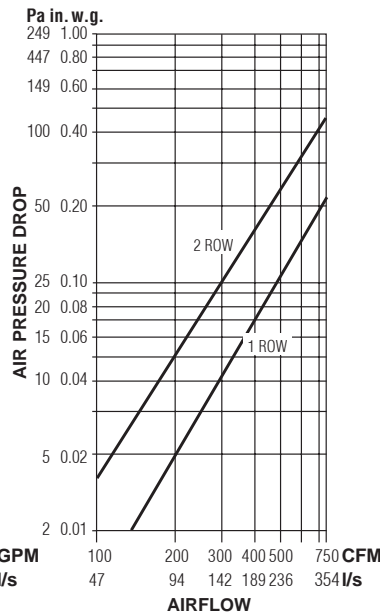

NOTES:

- Capacities are in MBH (kW), **thousands of Btu per hour (kiloWatts)**.
- MBH (kW) values are based on a Δt (temperature difference) of 110°F (61°C) between entering air and entering water. For other Δt 's; multiply the MBH (kW) values by the factors below.

- Air Temperature Rise.
 $ATR (°F) = 927 \times \frac{MBH}{cfm}$, $ATR (°C) = 829 \times \frac{kW}{I/s}$
- Water Temp. Drop.
 $WTD (°F) = 2.04 \times \frac{MBH}{GPM}$, $WTD (°C) = .224 \times \frac{kW}{I/s}$
- Connections: 1 Row 1/2" (13) and 2 Row 7/8" (22); O.D. male solder.

Altitude Correction Factors:

Altitude ft. (m)	Sensible Heat Factor
0 (0)	1.00
2000 (610)	0.94
3000 (914)	0.90
4000 (1219)	0.87
5000 (1524)	0.84
6000 (1829)	0.81
7000 (2134)	0.78

Correction factors at other entering conditions:

Δt °F (°C)	50 (28)	60 (33)	70 (39)	80 (44)	90 (50)	100 (56)	110 (61)	120 (67)	130 (72)	140 (78)	150 (83)
Factor	.455 (.459)	.545 (.541)	.636 (.639)	.727 (.721)	.818 (.820)	.909 (.918)	1.00 (1.00)	1.09 (1.10)	1.18 (1.18)	1.27 (1.28)	1.36 (1.36)

Performance Data • Hot Water Coil

Model: 37NW • Parallel Flow • Low Profile

Unit Size 3

1 Row (single circuit)

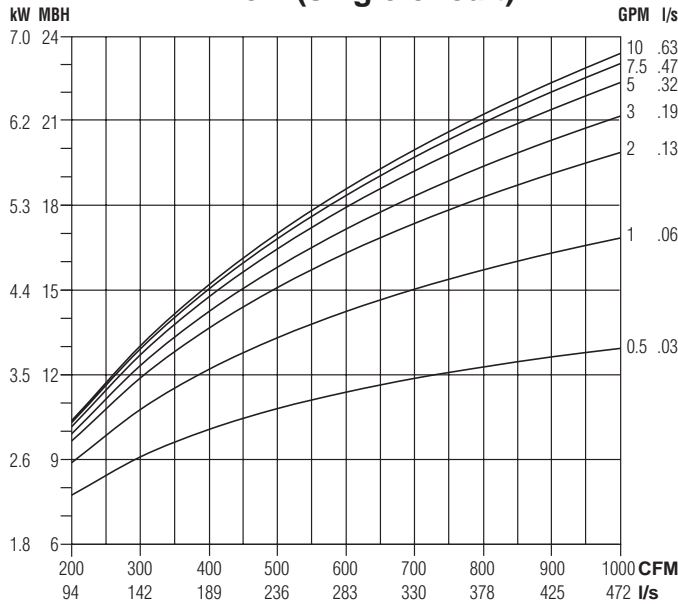

2 Row (multi-circuit)

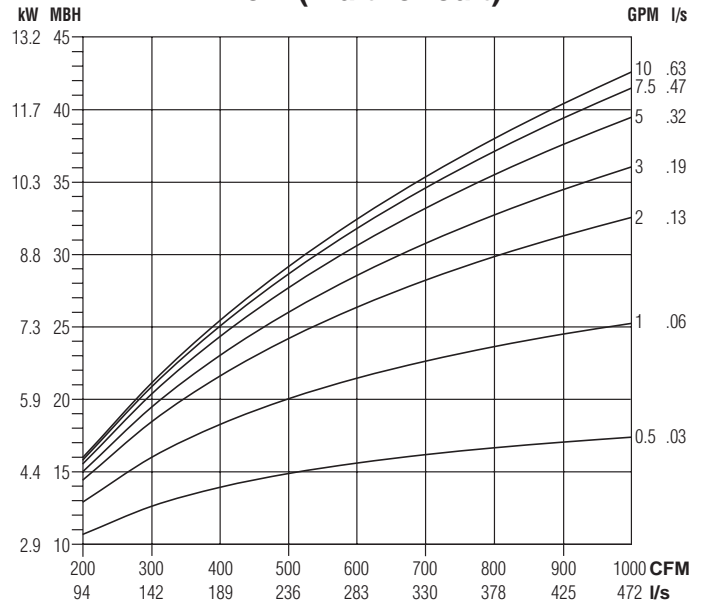

Water Pressure Drop

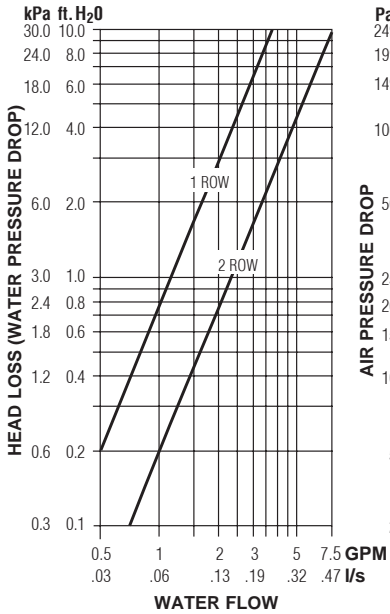

Air Pressure Drop

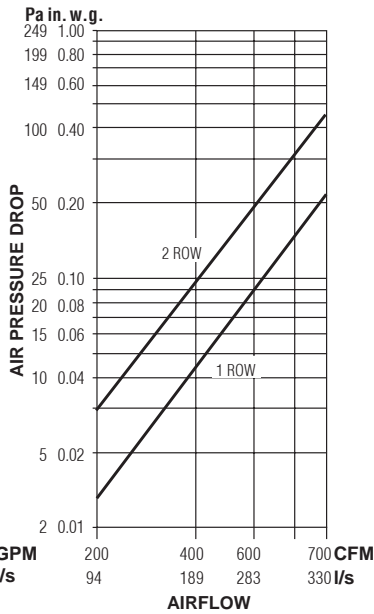

NOTES:

- Capacities are in MBH (kW), **thousands of Btu per hour (kiloWatts)**.
- MBH (kW) values are based on a Δt (temperature difference) of 110°F (61°C) between entering air and entering water. For other Δt 's; multiply the MBH (kW) values by the factors below.

- Air Temperature Rise.
 $ATR (^\circ F) = 927 \times \frac{MBH}{cfm}$, $ATR (^\circ C) = 829 \times \frac{kW}{l/s}$
- Water Temp. Drop.
 $WTD (^\circ F) = 2.04 \times \frac{MBH}{GPM}$, $WTD (^\circ C) = .224 \times \frac{kW}{l/s}$
- Connections: 1 Row 1/2" (13) and 2 Row 7/8" (22); O.D. male solder.

Altitude Correction Factors:

Altitude ft. (m)	Sensible Heat Factor
0 (0)	1.00
2000 (610)	0.94
3000 (914)	0.90
4000 (1219)	0.87
5000 (1524)	0.84
6000 (1829)	0.81
7000 (2134)	0.78

Correction factors at other entering conditions:

Δt °F (°C)	50 (28)	60 (33)	70 (39)	80 (44)	90 (50)	100 (56)	110 (61)	120 (67)	130 (72)	140 (78)	150 (83)
Factor	.455 (.459)	.545 (.541)	.636 (.639)	.727 (.721)	.818 (.820)	.909 (.918)	1.00 (1.00)	1.09 (1.10)	1.18 (1.18)	1.27 (1.28)	1.36 (1.36)

Performance Data • Hot Water Coil

Model: 37NW • Parallel Flow • Low Profile

Unit Size 4

1 Row (single circuit)

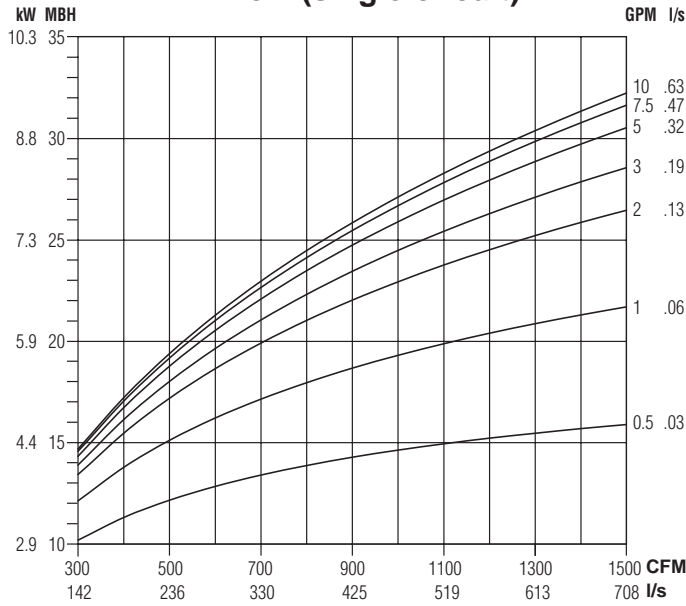

2 Row (multi-circuit)

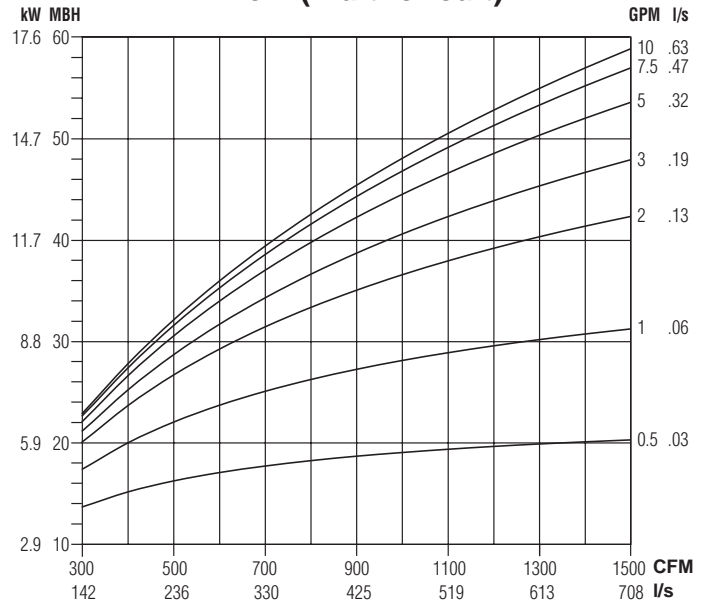

Water Pressure Drop

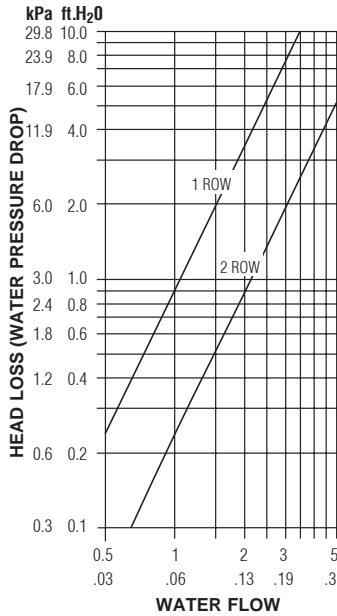

Air Pressure Drop

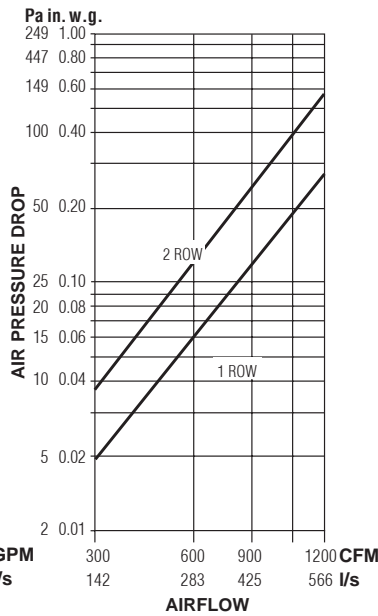

NOTES:

- Capacities are in MBH (kW), *thousands of Btu per hour (kiloWatts)*.
- MBH (kW) values are based on a Δt (temperature difference) of 110°F (61°C) between entering air and entering water. For other Δt 's; multiply the MBH (kW) values by the factors below.

- Air Temperature Rise.

$$\text{ATR (}^\circ\text{F)} = 927 \times \frac{\text{MBH}}{\text{cfm}}, \text{ ATR (}^\circ\text{C)} = 829 \times \frac{\text{kW}}{\text{l/s}}$$
- Water Temp. Drop.

$$\text{WTD (}^\circ\text{F)} = 2.04 \times \frac{\text{MBH}}{\text{GPM}}, \text{ WTD (}^\circ\text{C)} = .224 \times \frac{\text{kW}}{\text{l/s}}$$
- Connections: 1 Row 1/2" (13) and 2 Row 7/8" (22); O.D. male solder.

Altitude Correction Factors:

Altitude ft. (m)	Sensible Heat Factor
0 (0)	1.00
2000 (610)	0.94
3000 (914)	0.90
4000 (1219)	0.87
5000 (1524)	0.84
6000 (1829)	0.81
7000 (2134)	0.78

Correction factors at other entering conditions:

Δt °F (°C)	50 (28)	60 (33)	70 (39)	80 (44)	90 (50)	100 (56)	110 (61)	120 (67)	130 (72)	140 (78)	150 (83)
Factor	.455 (.459)	.545 (.541)	.636 (.639)	.727 (.721)	.818 (.820)	.909 (.918)	1.00 (1.00)	1.09 (1.10)	1.18 (1.18)	1.27 (1.28)	1.36 (1.36)

Performance Data Explanation

Sound Power Levels vs. NC Levels

The **Nailor Model Series: 35S, 35SST, 37S, 37SST, 35N and 37N** fan powered terminal unit performance data is presented in two forms.

The laboratory obtained discharge and radiated sound power levels in octave bands 2 through 7 (125 through 4000 Hz) center frequency for each unit size at various flow rates and inlet static pressures is presented. This data is derived in accordance with ANSI/ASHRAE Standard 130 and AHRI Standard 880. This data is raw with no attenuation deductions and includes AHRI Certification standard rating points.

Nailor also provides an "NC Level" table as an application aid in terminal selection, which include attenuation allowances as explained below. The suggested attenuation allowances are typical and are not representative of specific job site conditions. It is recommended that the sound power level data be used and a detailed NC calculation be performed using the procedures outlined in AHRI Standard 885, Appendix E for accurate space sound levels.

Explanation of NC Levels

Tabulated NC levels are based on attenuation values as outlined in AHRI Standard 885 Procedure for Estimating Occupied Space Sound Levels in the Application of Air Terminals and Air Outlets". AHRI Standard 885, Appendix E provides typical sound attenuation values for air terminal discharge sound and air terminal radiated sound.

As stated in AHRI Standard 885, Appendix E, These values can be used as a quick method of estimating space sound levels when a detailed evaluation is not available. The attenuation values are required for use by manufacturers to catalog application sound levels. In product catalogs, the end user environments are not known and the following factors are provided as typical attenuation values. Use of these values will allow better comparison between manufacturers and give the end user a value which will be expected to be applicable for many types of space.

Radiated Sound

Table E1 of Appendix E provides typical radiated sound attenuation values for three types of ceiling: Type 1 – Glass Fiber; Type 2 – Mineral Fiber; Type 3 – Solid Gypsum Board.

Since Mineral Fiber tile ceilings are the most common construction used in commercial buildings, these values have been used to tabulate Radiated NC levels.

The following table provides the calculation method for the radiated sound total attenuation values based on AHRI Standard 885.

	Octave Band					
	2	3	4	5	6	7
Environmental Effect	2	1	0	0	0	0
Ceiling/Space Effect	16	18	20	26	31	36
Total Attenuation Deduction	18	19	20	26	31	36

The ceiling/space effect assumes the following conditions:

1. 5/8" (16) tile, 20 lb/ft³ (320 kg/m³) density.
2. The plenum is at least 3 feet (914) deep.
3. The plenum space is either wide [over 30 feet (9 m)] or lined with insulation.
4. The ceiling has no significant penetration directly under the unit.

Discharge Sound

Table E1 of Appendix E provides typical discharge sound attenuation values for three sizes of terminal unit.

1. Small box; Less than 300 cfm (142 l/s)
[Discharge Duct 8" x 8" (203 x 203)].
2. Medium box; 300 – 700 cfm (142 - 330 l/s)
[Discharge Duct 12" x 12" (305 x 305)].
3. Large box; Greater than 700 cfm (330 l/s)
[Discharge Duct 15" x 15" (381 x 381)].

These attenuation values have been used to tabulate Discharge NC levels applied against the terminal airflow volume and not terminal unit size.

The following tables provide the calculation method for the discharge sound total attenuation values based on AHRI Standard 885.

Small Box <300 cfm	Octave Band					
	2	3	4	5	6	7
Environmental Effect	2	1	0	0	0	0
5 ft. (1.5 m) 1" (25) Duct Lining	2	6	12	25	29	18
Branch Power Division (1 outlet)	0	0	0	0	0	0
5 ft. (1.5 m), 8 in. dia. (203) Flex Duct	5	10	18	19	21	12
End Reflection	10	5	2	1	0	0
Space Effect	5	6	7	8	9	10
Total Attenuation Deduction	24	28	39	53	59	40

Medium Box 300 – 700 cfm	Octave Band					
	2	3	4	5	6	7
Environmental Effect	2	1	0	0	0	0
5 ft. (1.5 m) 1" (25) Duct Lining	2	4	10	20	20	14
Branch Power Division (2 outlets)	3	3	3	3	3	3
5 ft. (1.5 m), 8 in. dia. (203) Flex Duct	5	10	18	19	21	12
End Reflection	10	5	2	1	0	0
Space Effect	5	6	7	8	9	10
Total Attenuation Deduction	27	29	40	51	53	39

Large Box >700 cfm	Octave Band					
	2	3	4	5	6	7
Environmental Effect	2	1	0	0	0	0
5 ft. (1.5 m) 1" (25) Duct Lining	2	3	9	18	17	12
Branch Power Division (3 outlets)	5	5	5	5	5	5
5 ft. (1.5 m), 8 in. dia. (203) Flex Duct	5	10	18	19	21	12
End Reflection	10	5	2	1	0	0
Space Effect	5	6	7	8	9	10
Total Attenuation Deduction	29	30	41	51	52	39

1. Flexible duct is non-metallic with 1" (25) insulation.
2. Space effect (room size and receiver location) 2500 ft.³ (69 m³) and 5 ft. (1.5 m) distance from source.

For a complete explanation of the attenuation factors and the procedures for calculating room NC levels, please refer to the acoustical engineering guidelines at the back of this catalog and AHRI Standard 885.

Electric Heating Coils

Features, Selection and Capacities

Nailor Electric Coils are tested with terminal units in accordance with UL Standard 1995 and meet all requirements of the NEC (National Electric Code) and CSA (Canadian Standards Association). Units are listed and labeled by the ETL Testing Laboratory as a total package. All controls are enclosed in a NEMA 1 electrical enclosure on the side of the fan package for easy access.

All wiring for the motor and heater terminates in the enclosure for single point electrical connection in the field. Each unit is supplied with a wiring diagram. Note: NEC requires a means to disconnect the heater power supply within sight or on the terminal.

Standard Features:

- Automatic reset high limit thermal cut-outs.
- Magnetic contactors per stage on terminals with DDC or analog electronic controls.
- P.E. switch per stage to carry load or pilot duty with magnetic contactors as required with pneumatic control.
- Positive pressure airflow safety switch.
- P.E. switch for fan on parallel terminals (P35NE) with pneumatic control.
- Fan relay for DDC fan terminals.
- Control voltage transformer (Class II) for DDC or analog electronic terminals.
- Class A 80/20 Ni/Cr wire.

Options:

- Toggle disconnect switch.
- Door interlocking disconnect switch.
- Mercury contactors.
- Power circuit fusing.
- Dust tight control enclosure.
- Manual reset high limits.
- SCR Control.

SCR Control Option:

The SCR (Silicon Controlled Rectifier) option provides infinite solid state heater control using a proportional signal (0 – 10 Vdc or 4 – 20 mA). This option may be specified compatible with pneumatic, analog electronic or digital (DDC) controls.

Time proportional control of the electric heater provides superior comfort and energy savings. The SCR controller modulates the heater to supply the exact amount of heat based upon the zone requirement. Room set points are maintained more accurately, undershoot and overshoot as associated with staged heat are eliminated, reducing operation costs.

SCR controllers provide silent operation, as mechanical staged contactors are eliminated. Zero cross switching of the thyristor prevents electrical noise.



Models	Unit Size	Maximum KiloWatts - 1 Stage Heat				
		120 Volt 1 phase	208/240 Volt 1 phase	277 Volt 1 phase	208 Volt 3 phase	480 & 600 Volt 3 phase
33SZE	30	4.5	10*	11.5	14.5	15
	40	4.5	10*	11.5	14.5	18
	50	4.5	10*	11.5	14.5	25
35SE 35SEST	1	–	8	8	10	8
	2	–	8	8	10	8
	3	–	8	11.5	10	14
	4	–	8	11.5	10	16
	5	–	8	11.5	14.5	20.5
	6	–	8	11.5	14.5	26
	7	–	8	11.5	14.5	30
37SE 37SEST	1	–	5.5	5.5	5.5	5.5
	2	–	10.5**	12	12	12
	3	–	10***	12	15.5	17
	4	–	8	11.5	14.5	27
35NE	2	–	8	8	10	8
	3	–	8	11.5	10	14
	5	–	8	11.5	14.5	20.5
	6	–	8	11.5	14.5	26
37NE	2	–	8	11.5	11.5	11.5
	3	–	8	11.5	13.5	16
	4	–	8	11.5	14.5	27

*208V max is 8.5
 **208V max is 9.0
 ***208V max is 8.5

Recommended Selection:

The table above is a quick reference guide, to illustrate the relationship between electrical power supply, heater capacity in kiloWatts and terminal unit size that are available for fan powered units.

- Digital and pneumatic control terminals are available with up to 3 stages of heat. Analog electronic control terminals are available with 1 or 2 stages of heat only. A minimum of 0.5 kW per stage is required.

- Voltage and kilowatt ratings are sized so as not to exceed 48 amps, in order to avoid the NEC code requirement for circuit fusing.

- A minimum airflow of 70 cfm (33 l/s) per kW is required for any given terminal in order to avoid possible nuisance tripping of the thermal cutouts.

- Discharge air temperature should not exceed 120°F (49°C).



Tested and approved to the following standards:
ANSI/UL 1995, 1st ed.
CSA C22.2 No. 236.

Electric Heating Coils (continued)

Application Guidelines

Discharge Air Temperature

When considering the capacity and airflow for the heater, discharge air temperature can be an important factor. Rooms use different types of diffusers and they are intended to perform different functions. Slots that blend the air at the glass and set up air curtains within the room, must be able to blow the air very low in the room. Hot air will be too buoyant to be effective in this case. Discharge air temperatures for this application should be in the 85 – 90°F (29 – 32°C) range.

Diffusers in the center of the room blend their discharge air as it crosses the ceiling. Discharge air temperatures in this application can be as high as 105°F (41°C) and still be effective. However, if the return air grilles are in the discharge air pattern, the warm air will be returned to the plenum before it heats the room. Again, the air temperature needs to be blended down to an acceptable temperature that can be forced down into the occupied space by the time the air gets to the walls. Discharging warm air into the room at temperatures above 105°F (41°C) usually will set up stratification layers and will not keep the occupants warm if there is a ceiling return because only the top 12" – 24" (300 – 600 mm) of the room will be heated.

The maximum approved discharge air temperature for any Nailor Fan Powered Terminal Unit with supplemental heat is 120°F (49°C). No heater should be applied to exceed this temperature.

Electric Heater Selection

To properly select an electric heater, three things must be determined: the heat requirement for the room, the entering air temperature and the desired discharge air temperature. The heat requirement for the room is the sum of the heat loss calculation and the amount of heat required to raise the entering air temperature to the desired room temperature. Usually, the second item is small compared to the first for fan powered terminal units in a return air plenum. MBH can be converted to kW by using the chart or by calculation. There are 3.413 MBH in 1 kW. If using the chart, find the MBH on the left scale, then move horizontally to the right and read kW.

Next, the desired discharge air temperature should be ascertained. This will depend on the type of diffusers that are in the room.

The desired heating airflow for the room can then be calculated using the following equation:

$$cfm = \frac{kW \times 3160}{\Delta t \text{ (discharge air temp - inlet air temp.) } ^\circ F}$$

Assuming 70°F (21°C) supply air temperature to the heater, the room airflow can be selected directly from the chart. Start at the left at the design kW. Move horizontally to the desired discharge air temperature. Then, move vertically down to the cfm at the bottom of the chart.

The kW can be selected directly from the chart. Start at the bottom with the design cfm into the room. Move vertically up to the line that represents the desired discharge air temperature. Then, move left to the kW.

The discharge air temperature can also be selected directly from the chart. Start at the bottom with the design cfm into the room. Move to the left side of the chart and find the design kW. Move horizontally and vertically into the chart until the lines intersect. The intersection will be the desired discharge air temperature. Interpolation between the curves is linear.

Heater Selection Chart

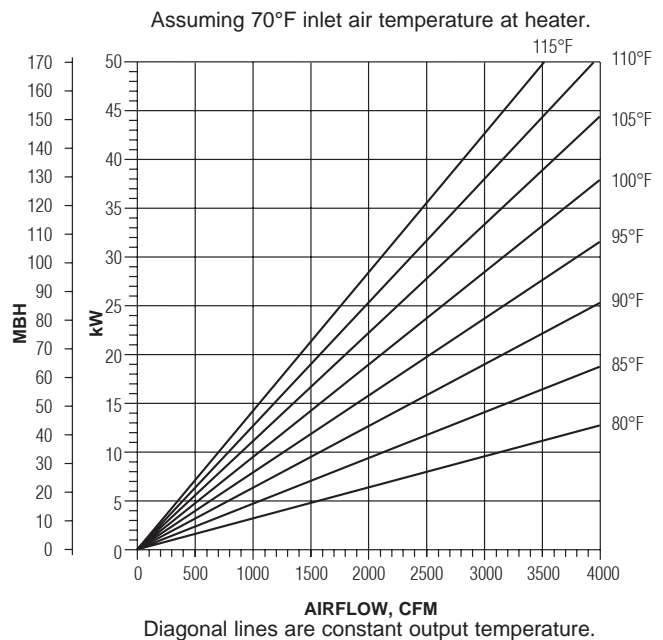

Optional Terminal Unit Liners For IAQ Sensitive Applications

Nailor offers several options for terminal unit applications where the maintenance of an high Indoor Air Quality is a primary concern. Specific IAQ liners are designed to address applications where the issue of fiberglass insulation eroding and entering the airstream is a concern and/or to reduce the risk of microbial growth.

The sound power levels published in this catalog for fan powered terminal units are based upon testing with standard dual density fiberglass insulation. Dual density insulation is surface treated to prevent erosion and was developed to optimize attenuation for terminal unit applications. Cataloged discharge sound levels for series terminals are not significantly affected by the different liner options, as the fan is mounted on the discharge, however radiated sound levels may escalate depending on the terminal model and liner selection. Contact your Nailor representative for further information.

Fiber-Free Liner

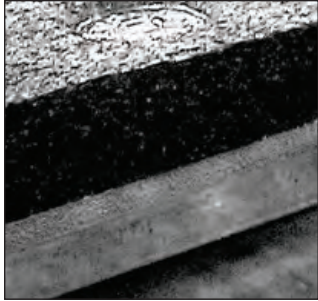

Fiber-Free liner.

Nailor's Fiber-Free liner is 3/4" (19) thick, closed cell elastomeric foam which totally eliminates fiberglass. The liner has excellent thermal insulating characteristics. The foam does not absorb water, reducing the likelihood of mold or bacterial growth.

The Fiber-Free liner surface is smooth, so that dirt and debris won't accumulate, durable, erosion resistant and washable.

Complies with the following standards and tests:

- NFPA 90A Supplementary materials for air distribution systems.
- ASTM E84 and UL 181 (25/50) Smoke and Flame spread.
- ASTM C1071, G21 and G22 (No bacterial or fungal growth).
- Acoustical attenuation of radiated sound is reduced compared with standard dual density fiberglass insulation.

Steri-Liner

Steri-Liner is an internal insulation designed to reduce the risk of microbial growth within the terminal. A smooth non-porous facing provides a vapor barrier to moisture and reduces the risk of micro-organisms becoming trapped. It also facilitates cleaning and prevents insulating material erosion. Damage to the liner though, will expose fiberglass particles to the airstream. Acoustic absorption of aluminum foil lined insulation is reduced for discharge sound levels and somewhat increased for radiated sound levels when compared to standard fiberglass insulation.

- 13/16" (21) thick, 4 lb./sq. ft. (64 kg/m³) density rigid fiberglass with a fire resistant reinforced aluminum foil-scrim-kraft (FSK) facing on all panels in the mixing chamber.
- Meets the requirements of NFPA 90A and UL 181 for smoke and flame spread and the bacteriological requirements of ASTM C665. Will not support the growth of fungi or bacteria, G21 and G22.
- No exposed edges. All Steri-Liner panels feature full length steel angle inserts and end caps to encapsulate the edges. Nailor's Stealth™ models with Steri-Liner are unique and have been especially designed, utilizing a low density foil back insulation with perforated metal covering in the tuned induction port that maintains cataloged radiated sound levels. No other manufacturer can maintain their cataloged sound levels like Nailor with a foil face liner option.

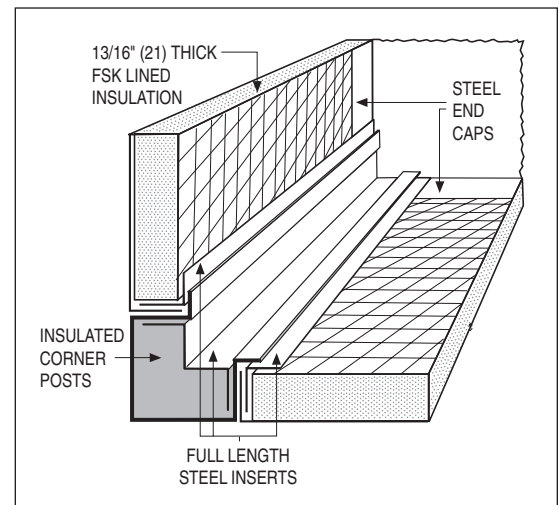

Steri-Liner detail on single duct terminal unit.

Solid Metal Liner

Nailor also offers a solid inner metal liner that completely isolates the standard insulation from the airstream within the terminal mixing chamber. Solid metal liners offer the ultimate protection against exposure of fiberglass particles to the airstream, all but eliminating the possibility of punctures exposing fiberglass. This option is also resistant to moisture. Fully performance tested for our clients, the Stealth™ series terminals with solid metal liner feature the tuned induction attenuation design described above for Steri-Liner and reduce cataloged radiated sound level ratings. No other terminal manufacturer can make that claim.

Perforated Metal Liner

Provides additional security and retains standard dual density fiberglass insulation or optional Steri-Liner insulation reducing possibility of long term erosion or breakdown.

Direct Digital Controls (DDC)

Microprocessor based technology is now commonplace in HVAC building management systems, particularly in larger building applications. Most controls companies have therefore developed DDC controllers and software programs for terminal units, to enhance energy efficient VAV systems and the well proven associated control strategies. VAV digital controllers are only one part of a much larger fully integrated building management system and the common availability and specification of terminal unit DDC controllers from control companies ensures compatibility and common protocol for trouble-free systems communication, maintenance support and trouble shooting. Digital VAV controls offer all the advantages of accurate, pressure independent operation plus the additional benefits of a networking capability and two-way communication. Parameters can be loaded and downloaded via communication with a remote PC.

Nailor has extensive experience factory mounting digital controls supplied by the temperature control contractor. Nailor has developed individual factory mounting programs for most manufacturers currently offering digital controls, providing the assurance of a high quality, professional installation and minimizing start-up problems.

Nailor has designed its terminal units to be generic in nature and compatible with all DDC controllers.

- Nailor supplies as standard a NEMA 1 full controls enclosure for protection of the controls during shipment, installation and for the life of the building HVAC system. Dust tight construction is an option.
- The vast majority of digital controls require a flow sensor. Nailor's Diamond Flow multi-point averaging sensor is compatible with all such controls. Nailor will mount its own sensor as standard, whether the digital controls are to be factory or field mounted, ensuring accurate measurement regardless of inlet conditions. Factors have been developed for loading into the flow control algorithm.
- UL Class 2 control transformers and disconnect switches are available from Nailor factory installed. All components carrying 120 VAC or higher should be supplied and installed by Nailor in order to maintain ETL listings.
- Separate isolation control transformers are available on fan terminal units to protect digital components from potentially harmful voltage spikes.
- An economical factory approved tri-state 24 VAC, 40 in. - lb. (4.5 Nm) torque direct drive actuator is available from Nailor when the DDC controller being mounted is available for use with a separate actuator.

Models: MEP-4003 60°/minute
MEP-5061 18°/minute



Optional Nailor supplied and mounted 'Tri-state' Series Actuator.

Nailor EZvav Digital Controls

The EZvav Digital Controls by Nailor bring simplicity to the Variable Air Volume (VAV) terminal unit market. Designed for both stand-alone applications and for integration with BACnet building automation systems, EZvav are precise P-I pressure independent VAV controllers that are pre-configured for standard control sequences that cover the vast majority of terminal unit applications.

All terminal units with electric or hot water heating coils are supplied as standard with a DAT Discharge Air Temperature control sensor that can limit the discharge air temperature to a maximum of 15°F above room set point, helping compliance with ASHRAE Standard 62.1 and 55.

Field commissioning and balancing can all be performed using the standard digital display room temperature sensor, which has an intuitive menu driven setup. No laptop, expansion modules, communication interface or software is required.



EZvav Digital Controls

Nailor EZvav Digital Controls (continued)

Features & Benefits:

- Integrated controller/actuator/transducer.
- Factory mounted and wired for new building applications.
- Ideal for retrofitting and upgrading pneumatic and analog controls to a digital solution.
- Room temperature sensor (thermostat) options include Digital Display, Occupancy Sensor and compact Rotary Dial models.
- Remote fan volume adjustment from 0 – 100% for EPIC ECM fan powered terminals.
- Simple menu driven setup.
- BACnet BMS network integration ready.

Application Control Sequences Include:

- Single Duct VAV or CAV Cooling only and Heat/Cool Changeover.
- Single Duct VAV Cooling with reheat.
- Dual Duct Variable Volume or Constant Volume control.
- Series Fan Powered Constant Volume with/without supplementary heat.
- Parallel Fan Powered Variable Volume with/without supplementary heat.

Heating Control Options:

Binary (up to 3 stages of electric heat), Modulating (0 – 10 Vdc analog) or Floating heat control.

Native BACnet

All models are BACnet Applications Specific Controllers that are ready to connect to a BACnet MS/TP network. Device instance, MAC address and baud rate are set from an STE-8001W36 without special software.

EZ to order

Nailor Representatives' Automated Pricing Program (RAPP) features EZ quick select options for control sequences and room temperature sensor options based on terminal unit type and application requirement.

EZ to install

For field retrofit applications, the EZvav controller is mounted within a terminal unit controls enclosure and directly coupled to the damper shaft. The flow sensor, power supply, heat and temperature sensors are then connected. The EZvav controller automatically detects them without programming or software tools.

EZ to setup, commission and balance

All options can be set by using an STE-8001W36 sensor as a technician's service tool or installed as a permanent room sensor. The EZvav Controller can be stocked by representatives to provide a simple digital solution to their customers that wish to upgrade their pneumatic or analog inventory to a new digital solution, perfect for retrofit applications!

EZvav Digital Controllers:

Model Number Application

BAC-8001-36	Single Duct Cooling and Heat/Cool changeover
BAC-8005-36	Single Duct with Reheat and Fan Powered Applications
BAC-8007-36	Dual Duct Master
TSP-8001-36	Dual Duct Secondary Actuator

Room Temperature Sensor (Thermostat) Options:



STE-8001W36 Digital Display

- Temperature readout in deg F or C. (and time of day when networked). User Set point adjustment.
- Field Commissioning Tool.
- Password Capable.



STE-8201W36 Digital Display with Occupancy Sensor

- Same Features as STE-8001W36 with Occupancy Motion Sensor that provides unoccupied, setback and standby control.



STE-6014W36 Rotary Dial

- Small, compact and discreet.
- Economical.
- Set point Adjustable Only.

CONTROLS
F

Nailor EZvav Digital Controls (continued)

Technical Specifications:

Inputs and Outputs

All inputs and outputs for EZvav controllers are set up at the factory and do not require field programming.

Inputs

- Sensors are automatically detected.
- Inputs accept industry-standard 10K ohm thermistor sensors.
- Input over voltage protection up to 24 volts AC, continuous.
- 12-bit analog-to-digital conversion.

Triac outputs

- Optically isolated triac output.
- Maximum switching 24 volts AC at 1.0 ampere for each output.
- Maximum for controller is 3.0 amperes.

Analog outputs

- Short-circuit protected.
- Output voltage 0–10 volts DC.
- 30 mA per output, 30 mA total for all analog outputs.
- 12-bit digital-to-analog conversion.

Airflow sensor

CMOS differential pressure 0–2 inches of water (0–500 Pa) measurement range. Internally linearized and temperature compensated.

- Configured as BACnet analog input object.
- Span accuracy 4.5% of reading.
- Zero point accuracy 0.0008 in. H₂O/0.2 Pa at 77° F (25° C).
- Barbed connections for 1/4 inch FR tubing.

Actuator

Torque 40 in-lb. (4.5 N.m)

Angular Rotation 0 to 95°
Adjustable end stops at 45 and 60° rotation

Motor Timing

90 sec./90° at 60 Hz. 108 sec./90° at 50 Hz.

Shaft size

Directly mounts on 3/8 to 5/8 inch (9.5 to 16 mm) round or 3/8 to 7/16 inch (9.5 to 11 mm) square damper shafts.

BACnet communication

- Integrated peer-to-peer BACnet MS/TP network communications.
- Network speed from 9600 to 76,800 baud.
- Meets or exceeds ANSI/ASHRAE BACnet Standard 135-2008 for Application Specific Controllers.

Installation:

Supply voltage 24 volts AC (–15%, +20%),
50–60 Hz, 5 VA, Class 2 only

Weight 13.2 ounces (376 grams)

Case material Gray and black flame retardant plastic

Environmental limits

Operating 32 to 120° F (0 to 49° C)

Shipping –40 to 140° F (–40 to 60° C)

Humidity 0–95% relative humidity (non-condensing)

Regulatory

- UL 916 Energy Management Equipment.
- BACnet Testing Laboratory listed as Application Specific Controller (ASC).
- CE compliant.
- SASO PCP Registration KSA R-103263.
- FCC Class B, Part 15, Subpart B and complies with Canadian ICES-003 Class B.

Digital Controls Factory Mounting Authorization Program

Nailor Industries Terminal Units are generic in nature and compatible with all DDC controls currently available.

Nailor usually supplies and mounts its own Diamond Flow multi-point averaging flow sensor.

Controls may be factory mounted and wired by **Nailor** or field installed by the controls contractor. Nailor has a wealth of experience supplying terminal units with digital controls supplied by the Air Temperature Control (ATC) contractor, a very common requirement in today's VAV marketplace.

We have worked with all major controls companies in recent years and have developed standard factory mounting programs to ensure the highest professional, quality installation. Nailor provides custom wiring diagrams in color for each individual project.

A 24 volt Class 2 control transformer and fan relay are provided by Nailor as standard on all fan powered terminals intended for use with digital controls in order to comply with UL and ETL requirements.

Standard Control Sequences • Fan Powered Terminal Units • Parallel Flow

Nailor EZvav • Pressure Independent

Control Sequence N400

Models: 35N and 37N

Cooling (Plenum Heat Only)

1. Changeover/Morning Warm-up (Central AHU Heat/Cool): If supply air as measured by the discharge air temperature (DAT) sensor is below 72°F (22.2°C), cool air is said to be available.

2. Cool Air Available: As space temperature rises above the cooling setpoint, the controller increases primary airflow. At a space temperature of 2°F (1.1°C) above the cooling setpoint, maximum cooling airflow is maintained. On a decrease in space temperature, the controller reduces airflow. Below cooling setpoint, minimum airflow is maintained.

3. The fan is started only on a call for heat. The fan stops if there is no call for heat. The fan induces warm ceiling plenum air. During occupied mode, the fan runs at maximum fan speed. EPIC ECM Motor Only: During standby and unoccupied modes, the fan runs at minimum fan speed.

4. As the space temperature drops below the heating setpoint, the fan continues to recirculate warm ceiling plenum air.

5. Warm Air Available: The fan is locked out. As space temperature drops below the heating setpoint, the controller increases primary airflow. At a space temperature of 2°F (1.1°C) below the heating setpoint, maximum heating airflow is maintained. On an increase in space temperature, airflow decreases. As space temperature rises above the heating setpoint, minimum heating airflow is maintained.

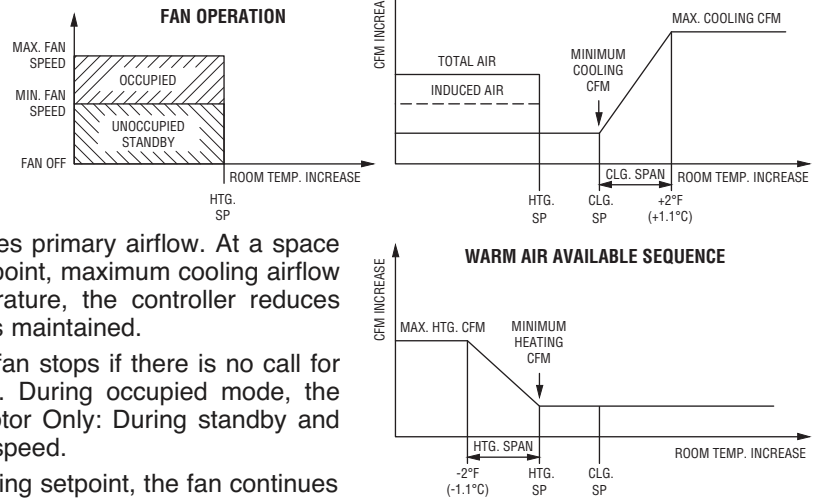

Control Sequence N402

Models: 35NE, 35NW, 37NE and 37NW

Cooling with Modulating Heat

1. Changeover/Morning Warm-up (Central AHU Heat/Cool): If supply air as measured by the discharge air temperature (DAT) sensor is below 72°F (22.2°C), cool air is said to be available. If supply air is above 76°F (24.4°C), warm air is said to be available. Any time warm air is available, auxiliary heat is locked out.

2. Cool Air Available: As space temperature rises above the cooling setpoint, the controller increases primary airflow. At a space temperature of 2°F (1.1°C) above the cooling setpoint, maximum cooling airflow is maintained. On a decrease in space temperature, the controller reduces airflow. Below cooling setpoint, minimum airflow is maintained.

3. The fan is started only on a call for heat. The fan stops if there is no call for heat. The fan induces warm ceiling plenum air. During occupied mode, the fan runs at maximum fan speed. EPIC ECM Motor Only: During standby and unoccupied modes, the fan runs at minimum fan speed.

4. Supplemental Heat: As the space temperature drops below the heating setpoint, the heating output modulates open. As the space temperature rises towards the heating setpoint, the heating modulates closed. If the heating loop is less than 10%, the heating output remains at 0%.

5. If DAT limiting is enabled and a DAT sensor is detected, the discharge air heating setpoint is determined based on the heating loop. The discharge temperature is limited to 15°F (8.3°C) above space temperature up to a maximum of 90°F (32.2°C).

6. Warm Air Available: The fan is locked out. As space temperature drops below the heating setpoint, the controller increases primary airflow. At a space temperature of 2°F (1.1°C) below the heating setpoint, maximum heating airflow is maintained. On an increase in space temperature, airflow decreases. As space temperature rises above the heating setpoint, minimum heating airflow is maintained.

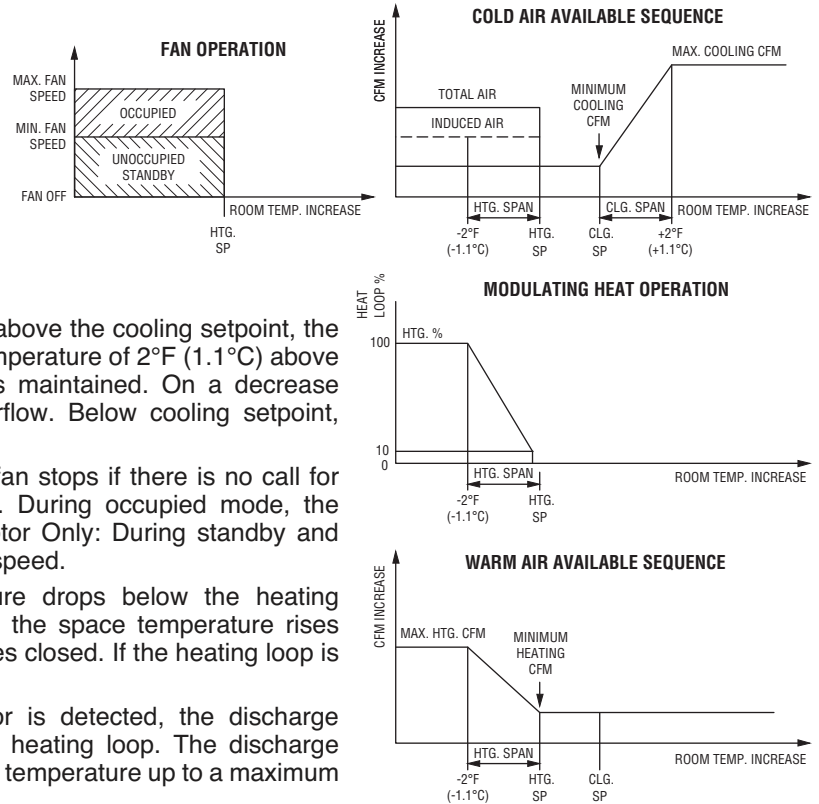

CONTROLS

F

Standard Control Sequences • Fan Powered Terminal Units • Parallel Flow

Nailor EZvav • Pressure Independent

Control Sequence N403

Models: 35NW and 37NW

Cooling with Floating Heat

1. Changeover/Morning Warm-up (Central AHU Heat/Cool): If supply air as measured by the discharge air temperature (DAT) sensor is below 72°F (22.2°C), cool air is said to be available. If supply air is above 76°F (24.4°C), warm air is said to be available. Any time warm air is available, auxiliary heat is locked out.
2. Cool Air Available: As space temperature rises above the cooling setpoint, the controller increases primary airflow. At a space temperature of 2°F (1.1°C) above the cooling setpoint, maximum cooling airflow is maintained. On a decrease in space temperature, the controller reduces airflow. Below cooling setpoint, minimum airflow is maintained.
3. The fan is started during occupied and standby modes and runs continuously at maximum fan speed. The fan induces warm ceiling plenum air as the primary airflow varies and maintains a constant volume to the space. During unoccupied mode, the fan starts on a call for heating only. The fan stops only during unoccupied mode when there is no call for heat. EPIC ECM Motor Only: During standby and unoccupied modes, the fan runs at minimum fan speed.
4. Supplemental Heat: As the space temperature drops below the heating setpoint (heating loop is greater than 70%), the valve is driven open. As the space temperature rises back toward the heating setpoint (heating loop is less than 30%), the valve is driven closed. If the loop is in between, there is no valve action.
5. If DAT limiting is enabled and a DAT sensor is detected, the discharge air heating setpoint is determined based on the heating loop. The discharge temperature is limited to 15°F (8.3°C) above space temperature up to a maximum of 90°F (32.2°C).
6. Warm Air Available: As space temperature drops below the heating setpoint, the controller increases primary airflow. At a space temperature of 2°F (1.1°C) below the heating setpoint, maximum heating airflow is maintained. On an increase in space temperature, airflow decreases. As space temperature rises above the heating setpoint, minimum heating airflow is maintained.

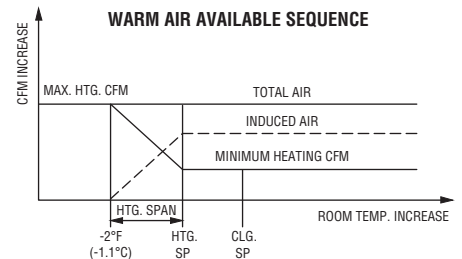
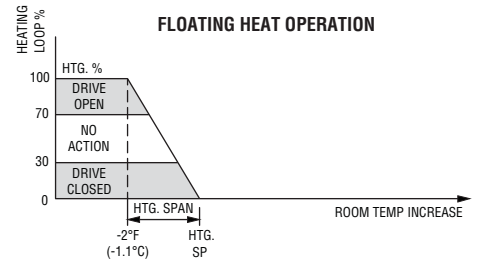
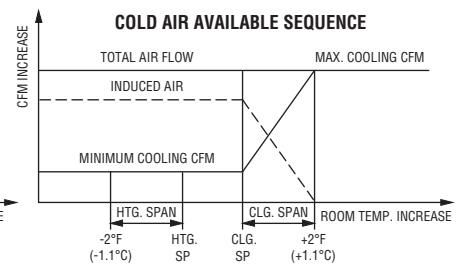
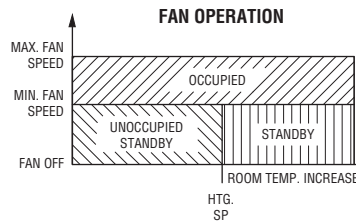

Standard Control Sequences • Fan Powered Terminal Units • Parallel Flow

Nailor EZvav • Pressure Independent

Control Sequence N404

Models: 35NE, 35NW, 37NE and 37NW

**Cooling with Binary Heat
(Staged Electric or On/Off Hot Water)**

1. Changeover/Morning Warm-up (Central AHU Heat/Cool): If supply air as measured by the discharge air temperature (DAT) sensor is below 72°F (22.2°C), cool air is said to be available. If

supply air is above 76°F (24.4°C), warm air is said to be available. Any time warm air is available, auxiliary heat is locked out.

2. Cool Air Available: As space temperature rises above the cooling setpoint, the controller increases airflow. At a space temperature of 2°F (1.1°C) above the cooling setpoint, maximum cooling airflow is maintained. On a decrease in space temperature, the controller reduces airflow. Below cooling setpoint minimum airflow is maintained.

3. The fan is started only on a call for heat. The fan stops if there is no call for heat. During occupied mode, the fan runs at maximum fan speed. EPIC ECM Motor Only: During standby and unoccupied modes, the fan runs at minimum fan speed.

4. Supplemental Heat: As the space temperature drops below the heating setpoint, up to 3 stages of electric heat are energized respectively. As the space temperature rises back toward the heating setpoint, heating stages 3, 2 and 1 turn off respectively (Alternatively, an on/off two position spring return hot water valve can be controlled).

5. Warm Air Available: The fan is locked out. As space temperature drops below the heating setpoint, maximum heating airflow is maintained. On an increase in space temperature, airflow decreases. As space temperature rises above the heating setpoint, minimum heating airflow is maintained.

Note: **DO NOT** enable the DAT Discharge Air Temperature limiting feature for binary staged or on/off reheat as short cycling will occur.

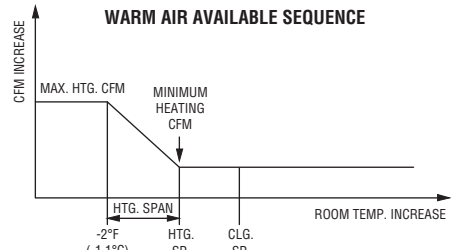
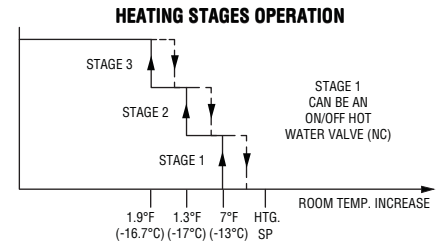
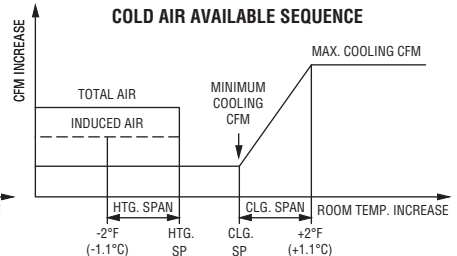
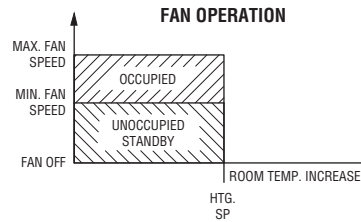

CONTROLS

F

Standard Control Sequences • Fan Powered Terminal Units • Parallel Flow

Model Series 35N and 37N

Pneumatic • Pressure Dependent

The actuator and fan respond directly to a signal from the room thermostat.

P.E. switches are furnished to sequentially activate fan and optional hot water heat upon demand (electric heat is not available with pressure dependent controls).

Pneumatic • Pressure Independent

Occupied Cycle

1. Upon start-up of the central system, cold air is delivered to the space through the primary air section at the flow rate dictated by the thermostat. The reset controller compensates for any variation in inlet static pressure. The fan remains off. A backdraft damper at the fan outlet prevents cold air from flowing back through the fan into the ceiling space.
2. On a rise in room temperature, the thermostat sends a signal to increase the flow of primary air.
3. When the room temperature exceeds set point by 2°F or more, cold airflow is maintained at the maximum setting.
4. On a decrease in room temperature, the thermostat sends a signal for less cooling to the flow controller and cold airflow begins to decrease.
5. When the room temperature is at or below the thermostat set point, cold airflow is at its minimum limit.
6. If room temperature continues to drop, the fan section is energized to supply warm ceiling plenum air.
7. If room temperature drops further still, an optional supplementary heating coil may be energized.
8. When the central system is turned off (night-time or weekend operation), the fan and optional heat can be energized by the room thermostat on an intermittent basis on a call for heating.

Pneumatic Options

1. Night Setback

The space temperature may be reset to a lower setting through a change in main air pressure. The fan and optional heat will be energized through the P.E. switch furnished with the unit while the central system remains off.

2. A normally open damper configuration may be utilized for a central morning warm-up sequence by removing main air to the terminal.

Pneumatic Control Combinations

Pressure Dependent	Pressure Independent	Thermostat Action	Terminal Damper	Primary Air Cooling Range Max. - Min.	Suggested Range Settings					Code
					Fan P.E. Switch**		Electric Heating Coil P.E. Off - On			
					Off - On Setting	Normal Position	1st Stage	2nd Stage	3rd Stage	
✓		D.A.	N.C.	15 - 10 psi	12 - 10/N.C.		10 - 8	9 - 7	8 - 6	D1
✓		R.A.	N.O.	5 - 10 psi	9 - 11/N.O.		11 - 13	12 - 14	13 - 15	D2
	✓	D.A.	N.O.	13 - 8 psi	10 - 8/N.C.		8 - 5	7 - 4	6 - 3	1P3
	✓	R.A.	N.O.	3 - 8 psi	6 - 8/N.O.		8 - 11	9 - 12	10 - 13	2P3
	✓	D.A.	N.C.	13 - 8 psi	10 - 8/N.C.		8 - 5	7 - 4	6 - 3	3P3
	✓	R.A.	N.C.	3 - 8 psi	6 - 8/N.O.		8 - 11	9 - 12	10 - 13	4P3

Notes: ** A normally closed (N.C.) P.E. switch fails on. A normally open (N.O.) P.E. switch fails off. Hot water coil valves (by others) should be selected to modulate through the desired heating range in sequence with the cooling range.

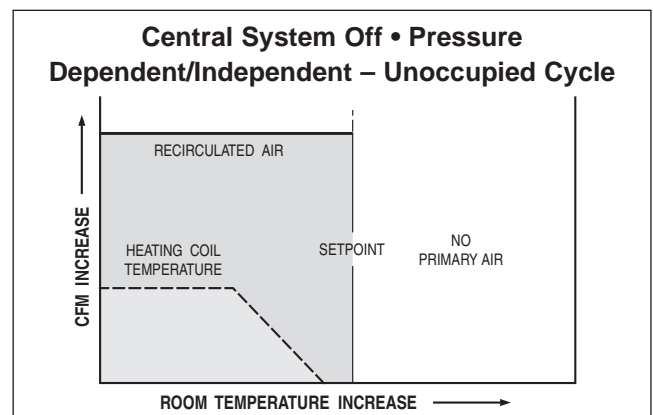
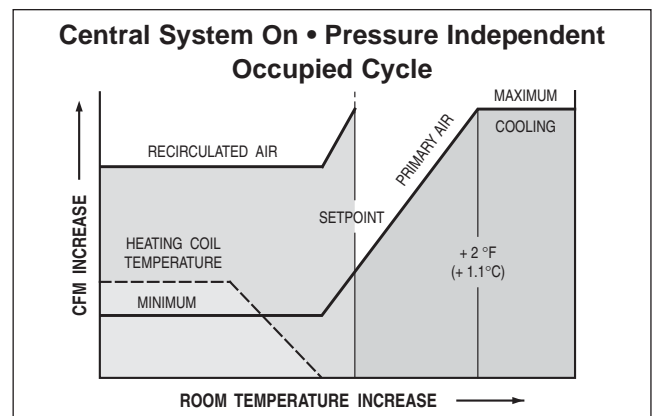
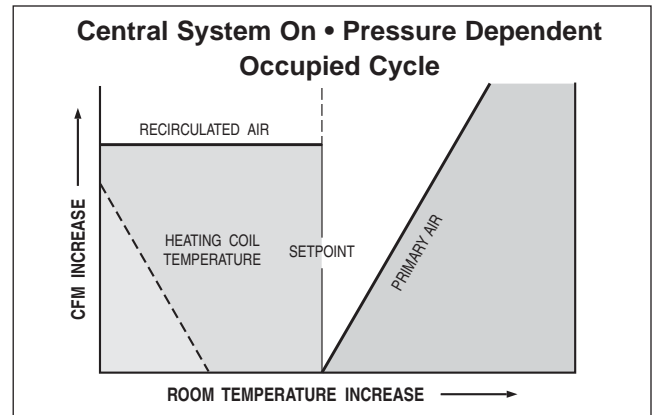

Fan Powered Terminal Units • 35N Series

Model 35N • Parallel Flow (Variable Volume) (continued)

13. All sound data shall be compiled in an independent laboratory and in accordance with the latest version of AHRI Standard 880. All units shall be AHRI certified and bear the AHRI certification label.

14. Unit maximum radiated and discharge sound power levels with fan only and 0.25" w.g. (63 Pa) discharge static pressure shall not exceed the values in Tables 1 and 2 at the specified airflow. No credit or reduction shall in any way be considered for room, plenum, ceiling, downstream duct, elbows and/or similar item effects.

Unit Size	Airflow		Sound Power Octave Band Center Frequency (Hz.)						
	cfm	l/s	2	3	4	5	6	7	
			125	250	500	1000	2000	4000	
2	400	189	67	60	58	52	45	43	
3	700	330	67	61	59	55	49	45	
5	1000	472	72	63	58	54	49	46	
6	1500	708	77	67	63	61	58	55	

Table 1. Maximum Radiated Sound Power Levels Heating Cycle (Fan only)

Unit Size	Airflow		Sound Power Octave Band Center Frequency (Hz.)						
	cfm	l/s	2	3	4	5	6	7	
			125	250	500	1000	2000	4000	
2	400	189	62	55	54	50	47	46	
3	700	330	62	56	56	53	50	47	
5	1000	472	67	58	57	54	51	49	
6	1500	708	67	64	63	62	59	58	

Table 2. Maximum Discharge Sound Power Levels Heating Cycle (Fan only)

15. Unit maximum radiated and discharge sound power levels with 100% primary air and fan off at 1.0" w.g. (249 Pa) inlet pressure and 0.25" w.g. (63 Pa) discharge static pressure shall not exceed the values in Table 3 and 4 at the specified airflow. No credit or reduction shall in any way be considered for room, plenum, ceiling, downstream duct, elbows and/or similar item effects.

Unit/ Inlet Size	Airflow		Sound Power Octave Band Center Frequency (Hz.)						
	cfm	l/s	2	3	4	5	6	7	
			125	250	500	1000	2000	4000	
2	700	189	62	57	51	39	38	36	
3	1100	330	65	59	54	46	41	37	
5	1600	472	67	60	53	45	43	42	
6	2100	708	70	62	57	50	47	45	

Table 3. Maximum Radiated Sound Power Levels Cooling Cycle (100% primary air and fan off)

Unit/ Inlet Size	Airflow		Sound Power Octave Band Center Frequency (Hz.)						
	cfm	l/s	2	3	4	5	6	7	
			125	250	500	1000	2000	4000	
2	700	189	70	66	59	54	52	54	
3	1100	330	69	67	60	54	56	57	
5	1600	472	70	67	61	53	54	56	
6	2100	708	73	68	62	56	59	60	

Table 4. Maximum Discharge Sound Power Levels Cooling Cycle (100% primary air and fan off)

OPTIONS

Electric Heat

(Substitute the following paragraphs:)

1. Furnish and install variable volume parallel fan powered terminal units with integral electric heat of the sizes and capacities as indicated on the drawings. Units shall be pressure independent with (digital, analog electronic, pneumatic) controls. Units shall be manufactured by **Nailor Industries Inc.** Model **35NE**.

2. An electric heater shall be factory mounted and pre-wired as an integral package with the fan powered terminal unit. Heaters shall be sized as shown on the drawings. The entire assembly including the electric heater shall be ETL listed for zero clearance and so labeled and shall meet all requirements of the latest National Electrical Code, CSA C22.2 No.236). The unit shall have a single point electrical (and pneumatic) connection. Heater casing and panel shall be a minimum of 20 ga. (1.00) galvanized steel. Each heater shall be complete with automatic reset high limit thermal cut-outs, control voltage transformer as required, ground terminal, fan relay for interlocking the heater and fan and high grade nickel chrome alloy resistance wire.

Element wires shall be suspended in insulators designed to expose the entire face area of the wire thereby eliminating hot spots. Each heater shall be supplied with factory supplied and pre-wired branch circuit fusing as required by NEC and UL. Circuiting and fusing shall also be in accordance with the circuiting requirements as shown on the plans.

Additional accessories shall include (control transformer, circuit fusing, disconnect switch, SCR controller, pneumatic electric switches) for staging the heater. (Additional performance requirements that you might want to include can be found in the electric heater section). The electric heater shall be located on the discharge side of the fan so as not to add heat to the motor and shorten its expected lifetime.

Coils rated up through 5 kW shall be single phase, 277 volt, 60 Hz and coils larger than 5 kW shall be three phase, four wire wye, 480 volt, 60 Hz. Electric heating coils up to and including 4 kW shall be single stage. Electric coils above 4 kW shall be two stage.

Hot Water Heating Coils

(Substitute the following paragraphs:)

1. Furnish and install Variable Volume Parallel Fan Powered Terminal Units with integral hot water coils of the sizes and capacities as indicated on the drawings. Units shall be pressure independent with (digital, analog electronic, pneumatic) controls. Units shall be manufactured by **Nailor Industries Inc.** Model **35NW**.

2. A hot water coil shall be factory mounted as an integral package with the fan powered terminal unit. Hot water coils shall be sized as shown on the drawings. The entire assembly including the hot water coil shall be ETL listed for zero clearance and so labeled and shall meet all requirements of the latest National Electrical Code (CSA C22.2 No.236). The unit shall have a single point electrical (and pneumatic) connection. Access panels on the bottom of the unit shall permit easy access to the coil for inspection and cleaning. Coils shall be 1, 2 or 3 row as required and heating capacities shall be as shown on the plans. Coils shall have aluminum plate fins spaced 10 per inch and bonded to 1/2" (13) O.D. copper tubes. Copper connections shall be sweat. All coils shall be tested at a minimum of 300 psi (2.1 MPa) under water to produce a guaranteed working pressure of 250 psi (1.7 MPa). Controls and valves for the hot water coils shall be field mounted. Heating coils shall be located on the discharge side of the fan so as not to add heat to the motor and shorten its expected lifetime.

Fan Powered Terminal Units • 35N Series

Model 35N • Parallel Flow (Variable Volume)

OPTIONS (continued)

Liner Options:

(Substitute in the appropriate specification section)

Steri-Liner

Unit shall be fully lined with non-porous, sealed liner which complies with NFPA 90A & 90B, ASTM E84, UL 723, UL 181 and ASTM G21 & G22. Installation shall be 13/16" (21) minimum thickness, 4 lb. 1 cu. ft. (64 kg/m³) density with reinforced aluminum foil-scrim-kraft (FSK) facing. All cut edges shall be secured with steel angles or end caps to encapsulate edges and prevent erosion. Insulation shall be Nailor Steri-Liner or equal.

Fiber-Free Liner

Unit shall be fully lined with a non-porous closed cell elastomeric foam liner which complies with NFPA 90A & 90B, ASTM E84, UL 723, UL 181. Installation shall be 3/4" (19) minimum thickness and secured to the interior of the terminal with mechanical fasteners. No fiberglass is permitted. Insulation shall be Nailor Fiber-Free Liner or equal.

EZvav Digital Controls

1.1 ASC VAV BACnet CONTROLLERS

A. Digital VAV Controllers shall be responsible for monitoring and controlling directly connected VAV Terminals as required. Controllers shall include fully adjustable analog outputs and digital outputs as required utilizing a proportional plus integral control loop to control damper, electric heat and hot water coils for the purpose of maintaining user setpoints. Each controller shall be classified as a native BACnet device, conforming to the BACnet Advanced Specific Controllers (B-ASC) profile, ANSI/ASHRAE BACnet Standard 135.

B. The VAV controller shall be available with integrated applications (based on model) for Single Duct, Dual Duct, and Fan Powered terminal units, including any of the following as required by the control sequence. For Single/Dual Duct terminals: Cooling Only, Cooling/Heating with Changeover and Morning Warm up. For Fan Powered terminals: Cooling with Reheat/Supplementary Heat, Heating coil operation may be with analog, floating or binary control as required.

C. The controller shall be fully configurable via the Digital Display Sensor, including communication parameters (instance, MAC, baud) and application settings (K-factor, flow limits, box configuration, reheat or fan type, default user setpoints, etc.), without any specific PC-based software. VAV controllers shall not require the use of a personal computer and PC based software and/or any interface modules.

D. The VAV controller shall be capable of being balanced from the Digital Room Sensor without any specific pc-based software.

E. The controller shall have integrated MS/TP communications. The communication port shall have network protection bulbs and integrated end-of-line (EOL) terminations.

F. The controller shall have an integrated actuator rated at 40 in-lbs. Connection to the damper shall be with a v-bolt clamp, accepting 3/8" to 5/8" damper shaft sizes. The actuator shall travel 0 to 95 degrees with adjustable end stops at 45 and 60 degrees of rotation. The actuator shall have an integrated gear disengagement mechanism.

G. The controller shall have an integrated transducer pressure sensor for airflow measurement. The sensor shall have a range of 0-2"wc, consuming and accurate to 4.5% of reading or 0.0008"wc, whichever is greater.

H. The controller shall have a Dedicated Room Sensor port for direct interface to a Digital Display Room Sensor or Discrete Room Sensor. The controller shall have the ability of detecting if a sensor has been connected to the port and identify its type, either digital display or discrete. Sensors shall be hot-swappable without powering down the controller. Sensor information via the ports shall not consume any of the devices terminated input capacity.

I. The controller shall have screw terminal blocks that can accommodate wire sizes 14-22 AWG. Terminals shall be color coded: black terminals for power, green terminals for input and outputs, and grey terminals for twisted-shielded-pair communication.

J. The power supply for the controller shall be 24 volts AC (-15%, +20%) power. Voltage below the operating range of the system shall be considered an outage.

1.2 DIGITAL ROOM SENSOR

A. The Digital Display Room Sensor (thermostat) shall provide space condition measurements and indications, including temperature and local motion/occupancy (optional), and user setpoint adjustments.

B. The Digital Room Sensor shall connect directly to the controller and shall not utilize any of the hardware I/O points of the controller. The Digital Display Room Sensor shall be able to be located up to 75' from the controller.

C. The Digital Display Room Sensor shall provide a Temporary Network Interface jack, field accessible without uninstalling the sensor, for connection to the BACnet MS/TP communication trunk to which the devices connected. The Digital Display Room Sensor, the connected controller, and all other devices on the BACnet network shall be accessible through the temporary communication jack. Microprocessor based sensors whose port only allows communication with the controller to which it is connected shall not be acceptable.

D. The Digital Display Room Sensor shall have an integrated sensor for temperature measurement as standard and a second integrated sensor for motion/occupancy (optional).

E. User/Occupant setpoints may be adjusted via the Digital Display Room Sensor.

F. The Digital Display Room Sensor shall have pre-configured menus for all control sequences allowing access to communication and application parameters.

G. The Digital Display Room Sensor shall have two levels of password protection: One level to protect user setpoint adjustment, and one level to protect configuration menu parameters. Passwords shall be at least 4 digits in length.

Fan Powered Terminal Units • 37N Series

Model 37N • Parallel Flow (Variable Volume) Low Profile

1. Furnish and install **Nailor 37N Series Low Profile Variable Volume Parallel Fan Powered Terminal Units** of the sizes and capacities as indicated on the drawings. Units shall be pressure independent with (digital, analog electronic, pneumatic) controls.
2. The entire terminal unit shall be designed and built as a single unit. The units shall be provided with a primary variable air volume damper that controls the air quantity in response to a (thermostat or digital controller/zone sensor). The units shall also include a fan that sequences on and off in response to the (thermostat or digital controller/zone sensor). The space limitations shall be reviewed carefully to ensure that all units will fit into the space allowed.
3. Unit casings shall be 20 ga. (1.00) galvanized steel. Unit shall be fully lined with fiberglass insulation which shall be 1/2" (13) thick dual density insulation complying with NFPA 90 for fire and smoke resistivity and UL 181 for erosion. Any cut edges of insulation shall be coated with NFPA 90 approved sealant.
4. The terminal casing shall have full size bottom access panels for easy access to motor and blower assembly and for maintenance and replacement of parts without disturbing duct connections. Access panels shall be attached to casing with (screws, 1/4 turn fasteners).
5. Units shall have round or rectangular inlets for the primary air connections and shall have a minimum 6" (152) deep inlet duct collar for field connection. Models with no heat or electric heat shall have rectangular outlets suitable for flanged duct connections. Models with hot water coils shall have an induction inlet designed to accept flanged hot water coils. Duct connection to hot water coil shall be flanged ducts. Casing shall have mounting area for hanging by sheet metal straps from a concrete slab.
6. The damper shall be round or rectangular and constructed of laminated 20 ga. (1.00) galvanized steel with a peripheral gasket and a solid steel 1/2" (13) diameter shaft, pivoted in self-lubricating bronze oilite bearings. Damper leakage shall not exceed 2% of the terminal rated airflow at 3" w.g. (746 Pa) inlet static pressure.
7. Entire terminal unit shall be factory assembled with (pneumatic, analog electronic) controls. All components including all controls except the room (thermostat or zone sensor) and (pneumatic piping, field wiring) shall be factory installed and mounted with the unit. Digital controls shall be supplied by BAS controls contractor. Digital controls are optionally factory mounted and wired.
8. Provide a (digital, analog electronic, pneumatic) flow control device that will limit the maximum and minimum airflow to that scheduled on the drawings. Control of the terminal unit shall be pressure independent.
9. The sequence of operation should be described here, if not part of the temperature controls specifications.
10. Blower casings shall be constructed of heavy gauge coated steel. Blower wheel shall be forward curved centrifugal type, dynamically balanced and driven by direct drive, single speed split capacitor motor(s). Motor(s) shall be suitable for 120 or 208 or 240 or 277 volt single phase power. Motors shall have built-in overload protection, bearings capable of low speed oiling, permanently oiled bearings and be of an anti-backward rotation design. Fan assembly shall be mounted so as to isolate the casing from the motor and blower vibration at no less than four points. Isolation shall be supplied at the motor and at the blower mounting points. A gasketed backdraft damper shall be included on the fan discharge to reduce primary air leakage back into the plenum space.
11. A solid state SCR fan speed controller sized and designed for the specific blower motor combination shall be provided to allow infinitely adjustable fan speed from the minimum voltage stop to the line voltage signal to the motor. A minimum voltage stop shall be employed to ensure that fan cannot run in stall mode.
12. Units shall incorporate a single point electrical and/or pneumatic connection for the entire unit. All electrical components shall be ETL listed or recognized and installed in accordance with the

National Electrical Code. All electrical components shall be mounted in a control box. The entire assembly shall be ETL listed and labeled to meet UL 1995 and CSA C22.2 No. 236.

13. All sound data shall be compiled in an independent laboratory and in accordance with the latest version of AHRI Standard 880. All units shall be AHRI certified and bear the AHRI certification label.

14. Unit maximum radiated and discharge sound power levels with fan only and 0.25" w.g. (63 Pa) discharge static pressure shall not exceed the values in Tables 1 and 2 at the specified airflow. No credit or reduction shall in any way be considered for room, plenum, ceiling, downstream duct, elbows and/or similar item effects.

Unit Size	Airflow		Sound Power Octave Band Center Frequency (Hz.)						
	cfm	l/s	2	3	4	5	6	7	
			125	250	500	1000	2000	4000	
2	550	260	69	59	56	50	46	38	
3	700	330	68	60	60	55	47	38	
4	825	389	69	61	61	56	47	39	

Table 1. Maximum Radiated Sound Power Levels Heating Cycle (Fan only)

Unit Size	Airflow		Sound Power Octave Band Center Frequency (Hz.)						
	cfm	l/s	2	3	4	5	6	7	
			125	250	500	1000	2000	4000	
2	550	260	70	60	56	51	41	43	
3	700	330	71	61	60	54	47	50	
4	825	389	70	60	62	56	49	50	

Table 2. Maximum Discharge Sound Power Levels Heating Cycle (Fan only)

15. Unit maximum radiated and discharge sound power levels with 100% primary air and fan off at 1.0" w.g. (249 Pa) inlet pressure and 0.25" w.g. (63 Pa) discharge static pressure shall not exceed the values in Table 3 and 4 at the specified airflow. No credit or reduction shall in any way be considered for room, plenum, ceiling, downstream duct, elbows and/or similar item effects.

Unit/ Inlet Size	Airflow		Sound Power Octave Band Center Frequency (Hz.)						
	cfm	l/s	2	3	4	5	6	7	
			125	250	500	1000	2000	4000	
2	700	330	71	59	50	43	40	32	
3	1100	519	69	61	54	46	39	35	
4	1600	755	70	59	53	48	44	41	

Table 3. Maximum Radiated Sound Power Levels Cooling Cycle (100% primary air and fan off)

Unit/ Inlet Size	Airflow		Sound Power Octave Band Center Frequency (Hz.)						
	cfm	l/s	2	3	4	5	6	7	
			125	250	500	1000	2000	4000	
2	700	330	70	65	59	53	41	36	
3	1100	519	75	69	63	55	47	41	
4	1600	755	75	68	64	56	49	49	

Table 4. Maximum Discharge Sound Power Levels Cooling Cycle (100% primary air and fan off)

Motor:

ECM

(Substitute the following paragraph:)

10. Blower casings shall be constructed of heavy gauge coated steel. Blower wheel shall be forward curved centrifugal type, dynamically balanced and driven by Electronically Commutated Motor(s). Motor(s) shall be suitable for 120 or 208 or 240 or 277 volt single phase power. Fan airflow volume shall be factory set. Fan assembly shall be mounted so as to isolate the casing from the motor and blower vibration at no less than four points. Isolation shall be supplied at the motor and at the blower mounting points. A gasketed backdraft damper shall be included on the fan discharge to reduce primary air leakage back into the plenum space.

Fan Powered Terminal Units • 37N Series

Model 37N • Parallel Flow (Variable Volume) Low Profile (continued)

OPTIONS

Electric Heat:

Model: 37NE Staged

(Substitute the following paragraphs:)

1. Furnish and install **Nailor Model 37NE Low Profile Variable Volume Parallel Fan Powered Terminal Units** with integral electric heat of the sizes and capacities as indicated on the drawings. Units shall be pressure independent with (digital, analog electronic, pneumatic) controls.

12. An electric heater shall be factory mounted and pre-wired as an integral package with the fan powered terminal unit. Heaters shall be sized as shown on the drawings. The entire assembly including the electric heater shall be ETL listed for zero clearance and so labeled and shall meet all requirements of the latest National Electrical Code, (CSA C22.2 No.236). The unit shall have a single point electrical and/or pneumatic connection (dual point electrical on 600V). Heater casing and panel shall be a minimum of 20 ga. (1.00) galvanized steel. Each heater shall be complete with automatic reset high limit thermal cut-outs, control voltage transformer as required, ground terminal, fan relay for interlocking the heater and fan and high grade nickel chrome alloy wire.

Element wires shall be supported by ceramic isolators. Each heater shall be supplied with factory supplied and pre-wired branch circuit fusing as required by NEC and UL. Circuiting and fusing shall also be in accordance with the circuiting requirements as shown on the plans.

Additional accessories shall include (control transformer, circuit fusing, disconnect switch, pneumatic electric switches) for staging the heater.

Proportional Heat (SCR)

(Substitute the following paragraphs:)

1. Furnish and install **Nailor Model 37NE Low Profile Variable Volume Parallel Fan Powered Terminal Units** with integral electric heat of the sizes and capacities as indicated on the drawings. Units shall be pressure independent with (digital, analog electronic, pneumatic) controls.

12. An electric heater shall be factory mounted and pre-wired as an integral package with the fan powered terminal unit. Heaters shall be sized as shown on the drawings. The entire assembly including the electric heater shall be ETL listed for zero clearance and so labeled and shall meet all requirements of the latest National Electrical Code, (CSA C22.2 No.236). The unit shall have a single point electrical and/or pneumatic connection (dual point electrical on 600V). Heater casing and panel shall be a minimum of 20 ga. (1.00) galvanized steel. Each heater shall be complete with automatic reset high limit thermal cut-outs, control voltage transformer as required, ground terminal, fan relay for interlocking the heater and fan and high grade nickel chrome alloy wire.

Element wires shall be supported by ceramic isolators. Each heater shall be supplied with factory supplied and pre-wired branch circuit fusing as required by NEC and UL. Circuiting and fusing shall also be in accordance with the circuiting requirements as shown on the plans.

Additional accessories shall include (control transformer, circuit fusing, disconnect switch, pneumatic electric switches) for heater control.

Heater shall be capable of providing proportional control of heater capacity from an input signal of 4 – 20 mA, 2 – 10 VDC or 0 – 10 VDC. The SCR controller shall provide a 1 – 24 VDC pulsed output to SSR(s) [solid state relay(s)] in proportion to zone heating demand. The SSR's shall switch with zero cross over to reduce system noise and thermal shock on heater coils.

Proportional Heat with Discharge Temperature Control (DTC)

(Substitute the following paragraphs:)

1. Furnish and install **Nailor Model 37NE Low Profile Variable Volume Parallel Fan Powered Terminal Units** with integral electric heat of the sizes and capacities as indicated on the drawings. Units shall be pressure independent with (digital, analog electronic, pneumatic) controls.

12. An electric heater shall be factory mounted and pre-wired as an integral package with the fan powered terminal unit. Heaters shall be sized as shown on the drawings. The entire assembly including the electric heater shall be ETL listed for zero clearance and so labeled and shall meet all requirements of the latest National Electrical Code, (CSA C22.2 No.236). The unit shall have a single point electrical and/or pneumatic connection (dual point electrical on 600V). Heater casing and panel shall be a minimum of 20 ga. (1.00) galvanized steel. Each heater shall be complete with automatic reset high limit thermal cut-outs, control voltage transformer as required, ground terminal, fan relay for interlocking the heater and fan and high grade nickel chrome alloy wire.

Element wires shall be supported by ceramic isolators. Each heater shall be supplied with factory supplied and pre-wired branch circuit fusing as required by NEC and UL. Circuiting and fusing shall also be in accordance with the circuiting requirements as shown on the plans.

Additional accessories shall include (control transformer, circuit fusing, disconnect switch, pneumatic electric switches) for heater control.

The SCR controller shall contain a discharge temperature sensor capable of limiting leaving air temperature to a user defined setpoint.

The SCR controller shall pulse the coil to maintain zone demand while providing the set maximum discharge air temperature. Upon measuring a discharge air temperature above the user defined setpoint, the controller shall reduce heater capacity to maintain maximum allowable discharge air temperature. The discharge air temperature setpoint shall be adjustable from 80 – 100°F (27 – 149°C) by use of a controller mounted potentiometer.

Hot Water Heating Coils:

Model: 37NW

(Substitute the following paragraphs:)

1. Furnish and install **Nailor Model 37NW Low Profile Variable Volume Parallel Fan Powered Terminal Units** with integral hot water coils of the sizes and capacities as indicated on the drawings. Units shall be pressure independent with (digital, analog electronic, pneumatic) controls.

12. A hot water coil shall be factory mounted as an integral package with the fan powered terminal unit. Hot water coils shall be sized as shown on the drawings. The entire assembly including the hot water coil shall be ETL listed, labeled and shall meet all requirements of the latest National Electrical Code (CSA C22.2 No.236). The unit shall have a single point electrical and/or pneumatic connection. Access panels on the bottom of the unit shall permit easy access to the coil for inspection and cleaning. Coils shall be 1 or 2 row as required and heating capacities shall be as shown on the plans. Coils shall have aluminum plate fins spaced 10 per inch and bonded to 1/2" (13) O.D. copper tubes. Copper connections shall be sweat. All coils shall be tested at a minimum of 350 psi (2.4 MPa) under water to produce a guaranteed working pressure of 300 psi (2.1 MPa). Controls and valves for the hot water coils shall be field mounted. Heating coils shall be located on the induction side of the fan.

Fan Powered Terminal Units • 37N Series

Model 37N • Parallel Flow (Variable Volume) Low Profile

OPTIONS (continued)

Liner: Steri-Liner

(Substitute the following paragraph:)

3. Unit casings shall be 20 ga. (1.00) galvanized steel. Unit shall be fully lined with non-porous, sealed liner which complies with NFPA 90A & 90B, ASTM E84, UL 723, UL 181 and ASTM G21 & G22. Installation shall be 1/2" (13) minimum thickness, 4 lb./cu. ft. (64 kg/m³) density with reinforced aluminum foil-scrim-kraft (FSK) facing. All cut edges shall be secured with steel angles or end caps to encapsulate edges and prevent erosion. Insulation shall be Nailor Steri-Liner or equal.

Fiber-Free Liner

(Substitute the following paragraph:)

3. Unit casings shall be 20 ga. (1.00) galvanized steel. Unit shall be fully lined with a non-porous closed cell elastomeric foam liner which complies with NFPA 90A & 90B, ASTM E84, UL 723 and UL 181. Installation shall be 3/8" (10) minimum thickness and secured to the interior of the terminal with mechanical fasteners. No fiberglass is permitted. Insulation shall be Nailor Fiber-Free Liner or equal.

EZvav Digital Controls

1.1 ASC VAV BACnet CONTROLLERS

A. Digital VAV Controllers shall be responsible for monitoring and controlling directly connected VAV Terminals as required. Controllers shall include fully adjustable analog outputs and digital outputs as required utilizing a proportional plus integral control loop to control damper, electric heat and hot water coils for the purpose of maintaining user setpoints. Each controller shall be classified as a native BACnet device, conforming to the BACnet Advanced Specific Controllers (B-ASC) profile, ANSI/ASHRAE BACnet Standard 135.

B. The VAV controller shall be available with integrated applications (based on model) for Single Duct, Dual Duct, and Fan Powered terminal units, including any of the following as required by the control sequence. For Single/Dual Duct terminals: Cooling Only, Cooling/Heating with Changeover and Morning Warm up. For Fan Powered terminals: Cooling with Reheat/Supplementary Heat, Heating coil operation may be with analog, floating or binary control as required.

C. The controller shall be fully configurable via the Digital Display Sensor, including communication parameters (instance, MAC, baud) and application settings (K-factor, flow limits, box configuration, reheat or fan type, default user setpoints, etc.), without any specific PC-based software. VAV controllers shall not require the use of a personal computer and PC based software and/or any interface modules.

D. The VAV controller shall be capable of being balanced from the Digital Room Sensor without any specific pc-based software.

E. The controller shall have integrated MS/TP communications. The communication port shall have network protection bulbs and integrated end-of-line (EOL) terminations.

F. The controller shall have an integrated actuator rated at 40 in-lbs. Connection to the damper shall be with a v-bolt clamp, accepting 3/8(B-ASC)" to 5/8(B-ASC)" damper shaft sizes. The actuator shall travel 0 to 95 degrees with adjustable end stops at 45 and 60 degrees of rotation. The actuator shall have an integrated gear disengagement mechanism.

G. The controller shall have an integrated transducer pressure sensor for airflow measurement. The sensor shall have a range or 0-2(B-ASC)"wc, consuming and accurate to 4.5% of reading or 0.0008(B-ASC)"wc, whichever is greater.

H. The controller shall have a Dedicated Room Sensor port for direct interface to a Digital Display Room Sensor or Discrete Room Sensor. The controller shall have the ability of detecting if a sensor has been connected to the port and identify its type, either digital display or discrete. Sensors shall be hot-swappable without powering down the controller. Sensor information via the ports shall not consume any of the devices terminated input capacity.

I. The controller shall have screw terminal blocks that can accommodate wire sizes 14-22 AWG. Terminals shall be color coded: black terminals for power, green terminals for input and outputs, and grey terminals for twisted-shielded-pair communication.

J. The power supply for the controller shall be 24 volts AC (-15%, +20%) power. Voltage below the operating range of the system shall be considered an outage.

1.2 DIGITAL ROOM SENSOR

A. The Digital Display Room Sensor (thermostat) shall provide space condition measurements and indications, including temperature and local motion/occupancy (optional), and user setpoint adjustments.

B. The Digital Room Sensor shall connect directly to the controller and shall not utilize any of the hardware I/O points of the controller. The Digital Display Room Sensor shall be able to be located up to 75' from the controller.

C. The Digital Display Room Sensor shall provide a Temporary Network Interface jack, field accessible without uninstalling the sensor, for connection to the BACnet MS/TP communication trunk to which the devices connected. The Digital Display Room Sensor, the connected controller, and all other devices on the BACnet network shall be accessible through the temporary communication jack. Microprocessor based sensors whose port only allows communication with the controller to which it is connected shall not be acceptable.

D. The Digital Display Room Sensor shall have an integrated sensor for temperature measurement as standard and a second integrated sensor for motion/occupancy (optional).

E. User/Occupant setpoints may be adjusted via the Digital Display Room Sensor.

F. The Digital Display Room Sensor shall have pre-configured menus for all control sequences allowing access to communication and application parameters.

G. The Digital Display Room Sensor shall have two levels of password protection: One level to protect user setpoint adjustment, and one level to protect configuration menu parameters. Passwords shall be at least 4 digits in length.