

## GENERAL PRODUCT OVERVIEW

### Leading The Industry

Providing products that incorporate the desires and requirements of the industry we serve has traditionally been a primary focus at Nailor.

We listened in-depth to the engineering and contracting community, asked a lot of questions and realized there was not a single line of fan powered terminals available that incorporated all the design features and performance criteria that satisfied their wishes.

After an extensive and intense period of research, design and development, we have produced a line of fan powered terminals that satisfy the vast majority of requirements the HVAC industry demands.

On the next page, you can see at a glance some of the unique universal features that have been incorporated into Nailor fan powered terminals, providing the benefits of high performance operation and many field-friendly features to aid installation.

All Nailor terminals include the following additional features as standard:

- Compatibility with digital, analog electronic and pneumatic controls.
- Fan motors and heaters are energized and dielectric tests are performed on every terminal to ensure correct operation prior to shipment.
- Custom fabricated motor/blower combinations are mounted on special heavy gauge angles and isolated from casing with rubber insulators.
- All motors incorporate an anti-backward rotation design to prevent backward rotation upon start-up.
- Units can be flipped in the field for right or left hand configuration except Model Series 33SZ.

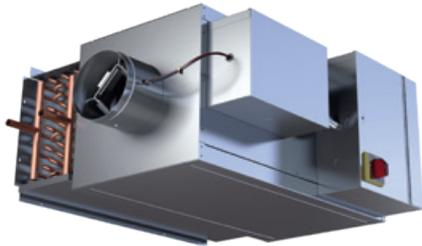

**Model Series 33SZ. Basic Unit**  
*Chilled Water, Series Flow, (Constant or Variable Volume)*

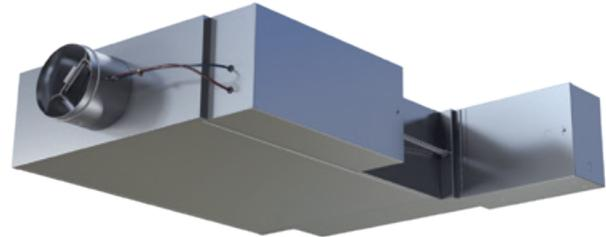

**Model Series 37SE, Electric Heat**  
*Series Flow (Constant or Variable Volume)*

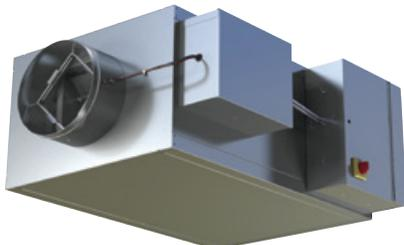

**Model Series 35S. Basic Unit**  
*Series Flow (Constant or Variable Volume)*

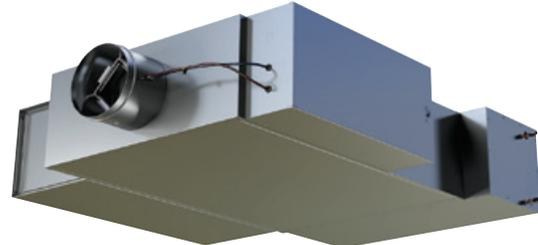

**Model Series 37SST Stealth™, Hot Water Heat**  
*Super Quiet, Series Flow (Constant or Variable Volume)*

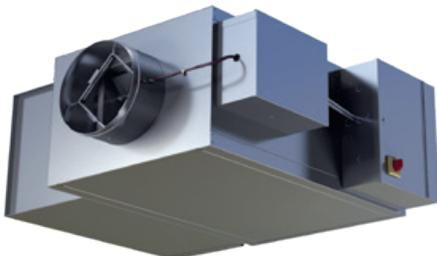

**Model Series 35SST Stealth™, Hot Water Heat**  
*Super Quiet, Series Flow (Constant or Variable Volume)*



**Model Series 35NW, Hot Water Heat**  
*Compact Design, Parallel Flow (Variable Volume)*

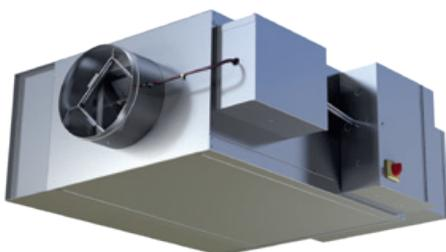

**Model Series 35SEXC Stealth™, Electric Heat**  
*Super Quiet, Series Flow (Variable Volume)*



**Model Series 37NW, Hot Water Heat**  
*Low Profile Design, Parallel Flow (Variable Volume)*

## Design Characteristics and Application

### Introduction

Fan Powered Terminal Units are an economical means of both cooling and periodically heating the perimeter zones of a building utilizing a single duct control system. In addition to inherent VAV economies, fan terminals utilize the free heat derived from lighting, people and other equipment and induce this warmer plenum air from the building core ceiling plenum space and re-circulate it to rooms calling for heating. If additional heating is required, optional supplementary heating coils may be activated. The need for a central source of warm air is eliminated.

During weekend or night-time operation, the central fans may be turned off. Heat, if required, may be provided by the terminal unit fan itself.

Fan Powered Terminal Units are the most popular design for office buildings because they provide performance benefits by reducing first cost, (such as lower central system fan HP and smaller ductwork), lower operating cost, the recovery of waste heat, and the capacity for improved air circulation and diffuser performance.

Fan terminals are available in two basic configurations; series or parallel flow. Each contains a fan motor assembly and a variable air volume damper to modulate primary air.

In a series unit (Fig. 1), the fan sits in the primary air stream and runs constantly when the zone is occupied. In a parallel unit (Fig. 2), the fan sits outside the primary air stream and runs intermittently.

Although both terminals can provide central fan HP savings, each terminal has different inlet static pressure requirements. Series fan terminals boost both induced air and primary air, so the inlet static pressure only needs to overcome the loss across the damper [less than 0.05" w.g. (12 Pa)] with Nailor terminals. Parallel fan terminals require enough static pressure to overcome the losses across the damper, the downstream ductwork and diffusers [typically 0.25 — 0.5" w.g. (62 — 124 Pa)] with Nailor terminals.

#### Series Flow Terminals – (Constant Volume)

A series fan powered terminal unit mixes primary air with induced plenum air by using a continuously operating fan during the occupied mode. It provides a constant volume of air to the space regardless of load.

As the cooling load decreases, the zone thermostat throttles the primary air valve. The terminal fan makes up the difference by inducing more return air from the plenum. At low cooling loads, the primary air may close or go to a minimum ventilation setting. If the zone temperature drops still further, the thermostat can energize optional supplemental heat. The sequence reverses when the load is increased.

The series terminal is therefore a constant volume, variable temperature unit. (See Fig. 3).

Series units should only be used with pressure independent controls. Series fans must be adjusted to match the maximum

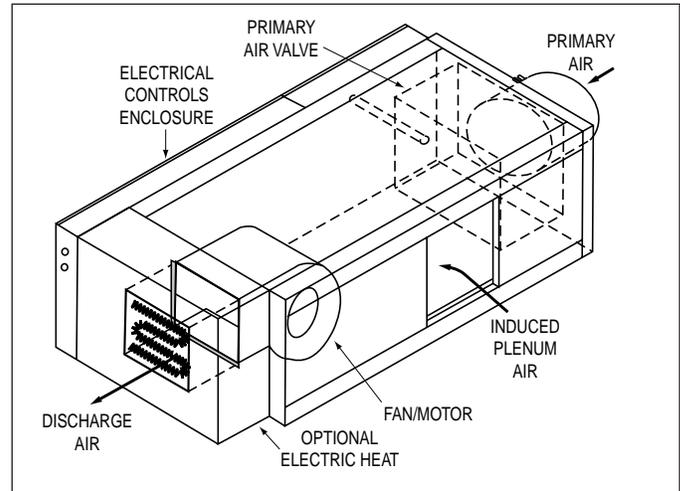

Figure 1. Series Fan Terminal

cooling cfm, to ensure that the primary air does not exceed the fan cfm as this would result in the short-circuiting of primary air directly into the ceiling plenum and waste energy. A pressure independent controller and inlet flow sensor controls the primary air valve to compensate for changes in inlet static pressure and ensures design cfm is maintained.

#### Parallel Flow Terminals – (Variable Volume)

Also called an intermittent fan terminal unit, a parallel unit modulates primary air in response to cooling demand and energizes the integral fan in sequence to deliver induced air to meet heating demand. The induction fan operating range should slightly overlap the range of the primary air valve. A backdraft damper ahead of the terminal fan restricts conditioned air from escaping into the return air plenum when the fan is off.

During full cooling demand, the thermostat positions the primary air valve for full airflow while the fan is de-energized. As the cooling load decreases, less primary air is delivered to the zone as the thermostat modulates the valve (functioning as a single duct VAV terminal).

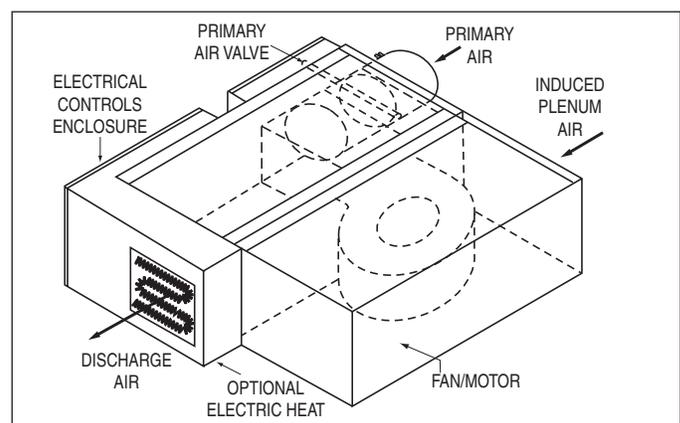

Figure 2. Parallel Fan Terminal

## Common Fan Terminal Components

The Diamond Flow multi-point averaging sensor is standard on all Nailor terminal units that are equipped with pressure independent controls.

In addition to the Diamond Flow multi-point averaging sensor and opposed blade damper configuration of the primary air valve that are described in detail on page O11 in this catalog, all Nailor fan powered terminals incorporate the following features and benefits.

### Single Speed PSC Induction Motors

All Nailor fan powered terminal units are currently equipped with single speed, direct drive, fractional horsepower, high efficiency, PSC motors as standard. These motors are manufactured to specifications developed by Nailor specifically for the fan powered terminal unit market. Some of the more important features of PSC motors are listed and explained below.

- **No Corona Effect**

Motors not only provide power, but act as transformers and generators. Under certain conditions, this causes the unused speed taps in multiple speed motors to have large potential or static charges present. While these charges are not doing any work, they will create damage to the windings if their potential voltages are greater than the winding insulating quality. This is often the case and lifetimes are shortened. Nailor fan powered terminal units do not suffer from this malady. All motors are single speed.

- **Wide Operating Ranges**

Nailor motors are designed to operate at rotational speeds lower than those of our competitors. This requires special stator wire sizing, special capacitor sizing and special bearings. These items are covered in our specifications. This assures you of high end performance equal to or better than any of our competitors and low end ranges below any of our competitors.

Low end performance is often ignored. Many times, this is because the range is not great enough to allow much difference, or because the low end performance is achieved by artificial means such as manual dampers to lower the airflows. Manual dampers lower airflows, but they increase RPM. Increased RPM puts back all the noise generated in the fan powered terminal unit as if it were still operating at full airflow. This is due to the noise caused by tip speed and vibration within the unit. High RPM, regardless of airflow will generate high noise.

Nailor solves this problem through low RPM for low airflows. Typically, the motors in Nailor fan powered terminal units can rotate as low as 350 RPM at low end, shedding as many as 14 to 20 decibels in the second and third octave bands depending on which unit is being selected. This means real sound level selections, units that can produce NC's of 30 and 35 when applied correctly and wider operating ranges on individual units for greater flexibility in the zone.

- **Permanently Lubricated Motors**

Nailor fan powered terminal units are equipped with permanently lubricated motors. The motors are equipped with oilers, but the oilers are not necessary as long as the units are operated in typical ambient temperature conditions. The specifications call for the oil reservoirs to have at least 50% of the original oil still in the reservoir after 50,000 hours of use under normal conditions.

- **Permanent Split Capacitor Design**

All Nailor fan powered terminal units are supplied with PSC motors as standard. The capacitors are sized to provide ample starting torque, even when turned down to the low minimums allowed on Nailor fan powered terminal units.

- **High Efficiency**

All Nailor PSC motors have the highest efficiency available in the market today. This too, is controlled by the Nailor motor specifications. Higher efficiency means lower operating expenses.

### PSC Fan Speed Controllers

Nailor designed its own solid state fan speed controllers. They are designed to operate with the specific motor and blower combinations as used in Nailor fan powered terminal units. They provide smooth and infinite adjustment of motor speed from maximum to the lowest preset low end limits found in the industry.

The speed controllers are largely responsible for the operating ranges of the motors. High quality standards allow very accurate low end stops. This assures Nailor customers of sound levels and performance as cataloged.

The matching of the motors and speed controllers allows Nailor fan powered terminal units lower watt consumption as motor RPM's are reduced. High efficiency is maintained from high end performance to low end performance. Very few of our competitors can make a similar claim.

### Low Noise Levels – AHRI Certified

In addition to those items listed above, Nailor holds down noise levels in the occupied space with heavy gauge metal casings, dual density insulation and multiple isolation points between motors and casings. Nailor is as quiet as any and far quieter than most of our competitors when controlling similar airflows on competitive equipment. Check out the sound data in this catalog. Notice there is no fine print covering the conditions under which the data does not apply. Notice that the minimum static requirement on series fan powered terminal units is 0.05" w.g. (12 Pa). Then notice the correspondingly low inlet static pressures on the parallel units. Notice that Nailor sound data is AHRI certified and independently certified by Energistics Laboratory, Houston. Compare that to the competition.

## ECM/EPIC FAN TECHNOLOGY®

- Significant energy savings (67% typical compared to PSC motors)
- Unique factory pre-set air volume capability (+/- 5%)
- Pressure independent fan operation
- LED for visual indication of air volume
- Field adjustable fan air volume controller
- Remote fan air volume adjustment capability from BAS
- Larger turn down ratios mean more flexibility for tenant changes



Since 1985, equipment manufacturers have used ECM's in residential air conditioners and furnaces. These motors have made it possible to achieve SEER ratings of 12 and higher. Nailor first introduced the ECM to the commercial HVAC market (ASHRAE Journal, April 1997) as an option for use in series fan powered terminal unit applications.

### WHAT IS AN ECM?

The ECM (Electronically Commutated Motor) is an ultra high efficiency programmable brushless DC motor utilizing a permanent magnet motor and a built-in AC/DC converter. DC motors are significantly more energy efficient than AC motors and much easier to control. The major weakness of series fan powered terminal units until now, has been their low fan motor efficiency. The widely used single speed fractional horsepower PSC (Permanent Split Capacitor) induction motor in combination with an electronic SCR speed controller is extremely inefficient at typical operating conditions. Due to acoustical considerations, the fan motor is usually adjusted to operate at considerably less than full load (where PSC motor efficiencies may be as high as 62%). PSC motor efficiency drops off dramatically when turned down; typically by at least half. Installed PSC motor efficiencies are therefore typically in the range of only 12 – 45%. ECM's in contrast, maintain a high efficiency of 78 – 83% at all speeds.

In addition to lower operating costs, ECM / EPIC Fan Technology® allows Nailor to pre-set the fan airflow volume at the factory for constant volume units or modulate the fan across wide ranges as zone loads change.

Figure 1. shows the lower watts per cfm translating into lower operating costs as shown on Figure 2, and wider operating ranges of series terminals employing ECM versus PSC induction motors.

### FEATURES AND BENEFITS OF ECM

Soft starts and slewed speed ramps are programmed into the ECM eliminating stress transmitted to the mounting bracket or hardware. They incorporate ball bearings providing permanent lubrication unlike sleeve bearings requiring a minimum RPM operation for oiling. The wider operating range of the ECM allows much more flexibility in zone applications. This feature alone provides several benefits; a simpler

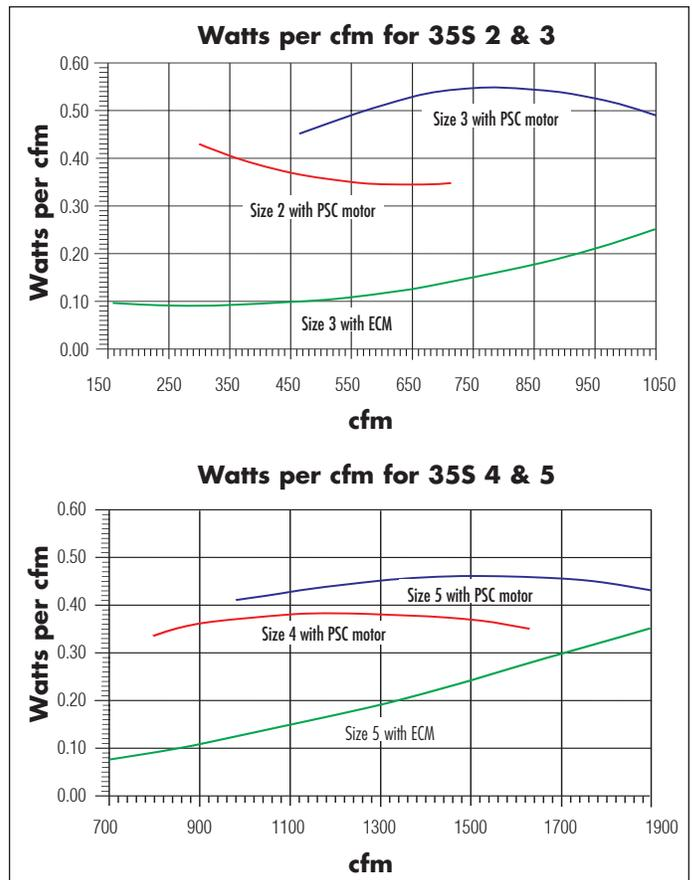

Figure 1. Power consumption comparison of ECM versus PSC motors.

product line to choose from, little or no equipment changes necessary when tenants change, more similar sized units on the job, decreased spare parts inventory and increased contractor flexibility. The low operating temperature of the ECM motor (essentially ambient) requires very little energy to offset the heat gain from the motor.

## ECM/EPIC FAN TECHNOLOGY®

These features also extend the life of the ECM, which are expected to provide an average 90,000 hours of operation. This translates into about 25 years for a typical series fan powered terminal unit. In addition to these standard features are two primary benefits; energy savings and the ability to pre-set the fan airflow volume at the factory.

### HOW DO YOU PRE-SET FAN AIRFLOW?

Pre-setting the fan airflow (cfm) has always been a problem for fan powered terminal manufacturers for two major reasons. First is that AC motors are not synchronous machines and second the RPM and consequently the unit cfm, changes when static pressure changes. The difficulty in pre-setting the fan lies in estimating the motor workload required at the job site in actual working conditions. The fan will not produce the same volume of air as it did at the factory without the duct work. Because there is no way to accurately predict the downstream static pressure as it would exist at the job site, it was impossible to pre-set the fan cfm. The ECM's are DC and inherently synchronous machines. The motors are programmed to calculate the work they are doing and then compare the work accomplished to the cfm requirement. The integral microprocessor based controller automatically adjusts the speed and torque in response to system pressure changes and pressure independent constant airflow operation is achieved without the need for an external flow sensor feedback loop.

Nailor series fan powered terminal units incorporate our own custom EPIC fan controller. An electronic PWM volume control device that allows adjustment of airflow volume. This value can be pre-set on the assembly line. It is field adjustable either manually using a screwdriver and voltmeter locally at the terminal or more conveniently, remotely using a 0 – 10 VDC analog output from a digital controller via the BAS. A fan volume versus DC volts calibration chart is provided. The importance of this feature is that the balancer never has to go into the ceiling to adjust the fan. This relieves the balancer of most of his work per zone on fan powered terminal units and related headaches. This also removes the uncertainty of diffuser flow measurement with hoods. Laboratory tests show the fan cfm to be accurate within +/- 5% of the factory set point. This is a huge benefit to the owner, the controls contractor, the mechanical contractor and the ceiling contractor.

### ENERGY SAVINGS

The following graphs show the energy savings of units with ECM's compared to units with Nailor engineered PSC motors. Since PSC motors used by Nailor are built specifically for Nailor fan powered terminal units and are more efficient than those used by most of our competitors.

A comparison using Nailor units with ECM's and a competitor's units with PSC motors would show even greater savings.

The typical range of operation for the size 3 would be 200 to about 900 cfm (94 to 425 l/s). The typical range of operation for the size 5 unit would be 700 to 1700 cfm (330 to 802 l/s).

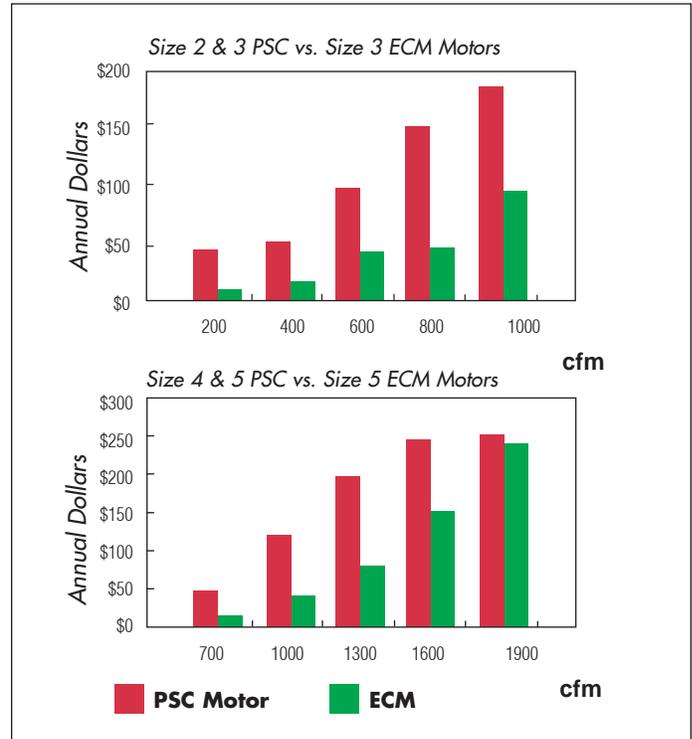

Figure 2. Typical operating cost comparison.

### WHAT IS THE PAYBACK PERIOD ON ECM MOTORS?

The payback period varies. It depends on which unit you use, where you set the cfm, how much you run the equipment and what you are paying for electricity. The graphs above are calculated assuming 66 hours per week operations and \$ .10 per kWh. If you run the equipment longer in your building or if you pay more for electricity, the payback will change proportionally. Considering the pre-set capability of the motor, there should be an up-front savings on balancing. That should be rebated to the owner and should be considered as part of the payback from the motor. Typically, with the balancing rebate and the operating expenses as shown above, the payback period should be anywhere from 6 to 18 months.

## Recommended Primary Valve Airflow Ranges For All Fan Powered Terminal Units

The recommended airflow ranges below are for fan powered terminal units with pressure independent controls and are presented as ranges for total and controller specific minimum and maximum airflow. Airflow ranges are based upon maintaining reasonable sound levels and controller limits using Nailor's Diamond Flow Sensor as the airflow measuring device. For a given unit size, the minimum, auxiliary and the maximum flow setting must be within the range limits to ensure pressure independent operation, accuracy and repeatability.

Minimum airflow limits are based upon .02" w.g. (5 Pa) differential pressure signal from Diamond Flow Sensor on analog/digital controls and .03" (7.5) for pneumatic controllers. This is a realistic low limit for many transducers used in the digital controls industry. Check your controls supplier for minimum limits. Setting airflow minimums lower, may cause hunting and failure to meet minimum ventilation requirements.

The high end of the tabulated Total Airflow Range on pneumatic and analog electronic controls represents the Diamond Flow Sensor's differential pressure reading at 1" w.g. (249 Pa). The high end airflow range for digital controls is represented by the indicated transducer differential pressure.

ASHRAE 130 "Performance Rating of Air Terminals" is the method of test for the certification program. The "standard rating condition" (certification rating point) airflow volumes for each terminal unit size are tabulated below per AHRI Standard 880. These air volumes equate to an approximate inlet velocity of 2000 fpm (10.2 m/s).

When digital or other controls are mounted by Nailor, but supplied by others, these values are guidelines only, based upon experience with the majority of controls currently available. Controls supplied by others for factory mounting are configured and calibrated in the field. Airflow settings on pneumatic and analog controls supplied by Nailor are factory preset when provided.

### Imperial Units, Cubic Feet per Minute

Inlet Size	Inlet Type	Total Airflow Range, cfm	Airflow at 2000 fpm Inlet Velocity (nom.), cfm	Range of Minimum and Maximum Settings, cfm							
				Pneumatic 3000 Controller		Analog Electronic Controls		Digital Controls			
						Transducer Differential Pressure ( w.g.)					
				Min.	Max.	Min.	Max.	Min.	Max.	Max.	
.03	1.0	.02	1.0	.02	1.0	1.25	≥ 1.5				
4	Round	0 – 225	150	30	180	25	180	25	180	200	225
5		0 – 400	250	55	325	45	325	45	325	360	400
6		0 – 550	400	80	450	65	450	65	450	500	550
7		0 – 800	550	115	650	95	650	95	650	725	800
8		0 – 1100	700	155	900	125	900	125	900	1000	1100
10		0 – 1840	1100	260	1500	215	1500	215	1500	1675	1840
12		0 – 2500	1600	355	2050	290	2050	290	2050	2290	2500
14		0 – 3370	2100	475	2750	390	2750	390	2750	3075	3370
16		0 – 4510	2800	640	3700	520	3700	520	3700	4120	4510
12		Flat Oval	0 – 2500	1600	355	2050	290	2050	290	2050	2300
14	0 – 3125		2100	440	2550	360	2550	360	2550	2850	3125
16	0 – 3725		2800	525	3040	430	3040	430	3040	3400	3725
18	0 – 5265		3500	750	4300	610	4300	610	4300	4800	5265
14 x 8	Rect.	0 – 2450	1560	350	2000	290	2000	290	2000	2240	2450
14 x 10		0 – 2950	1900	420	2400	340	2400	340	2400	2700	2950

### Metric Units, Liters per Second

Inlet Size	Inlet Type	Total Airflow Range, l/s	Airflow at 10.2 m/s Inlet Velocity (nom.), l/s	Range of Minimum and Maximum Settings, l/s							
				Pneumatic 3000 Controller		Analog Electronic Controls		Digital Controls			
						Transducer Differential Pressure ( Pa )					
				Min.	Max.	Min.	Max.	Min.	Max.		
7.5	249	5	249	5	249	311	≥ 374				
4	Round	0 – 106	71	14	85	12	85	12	85	94	106
5		0 – 189	118	26	153	21	153	21	153	170	189
6		0 – 260	189	38	212	31	212	31	212	236	260
7		0 – 378	260	54	307	45	307	45	307	342	378
8		0 – 519	330	73	425	59	425	59	425	472	519
10		0 – 868	519	123	708	101	708	101	708	790	868
12		0 – 1180	755	168	967	137	967	137	967	1081	1080
14		0 – 1590	991	224	1298	184	1298	184	1298	1451	1590
16		0 – 2128	1321	302	1746	245	1746	245	1746	1944	2128
12		Flat Oval	0 – 1180	755	168	967	137	967	137	967	1085
14	0 – 1475		991	208	1203	170	1203	170	1203	1345	1475
16	0 – 1758		1321	248	1435	203	1435	203	1435	1604	1758
18	0 – 2485		1652	354	2029	288	2029	288	2029	2265	2485
14 x 8	Rect.	0 – 1156	736	165	944	137	944	137	944	1057	1156
14 x 10		0 – 1392	897	198	1133	160	1133	160	1133	1274	1392

## Performance Data • Hot Water Coil

Models: 35SW, 35SWST, 35SW-OAI, 35SWST-OAI, 35SW-CVP • Series Flow

### Unit Size 6

#### 1 Row (multi-circuit)

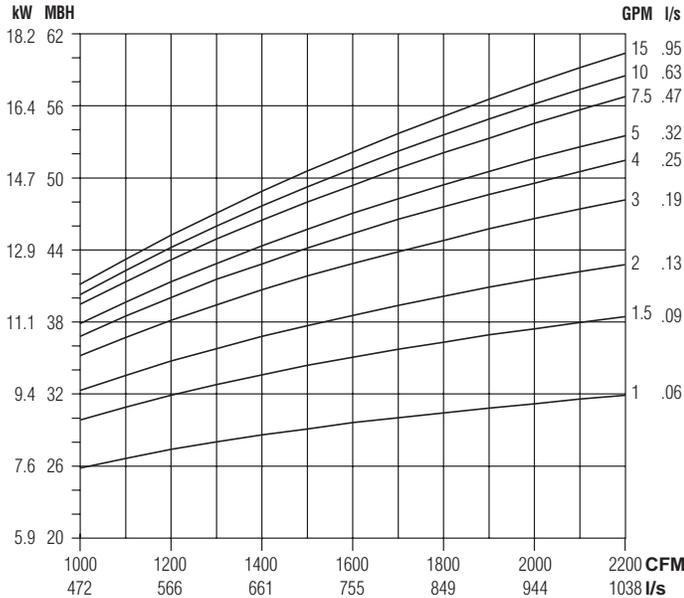

#### 2 Row (multi-circuit)

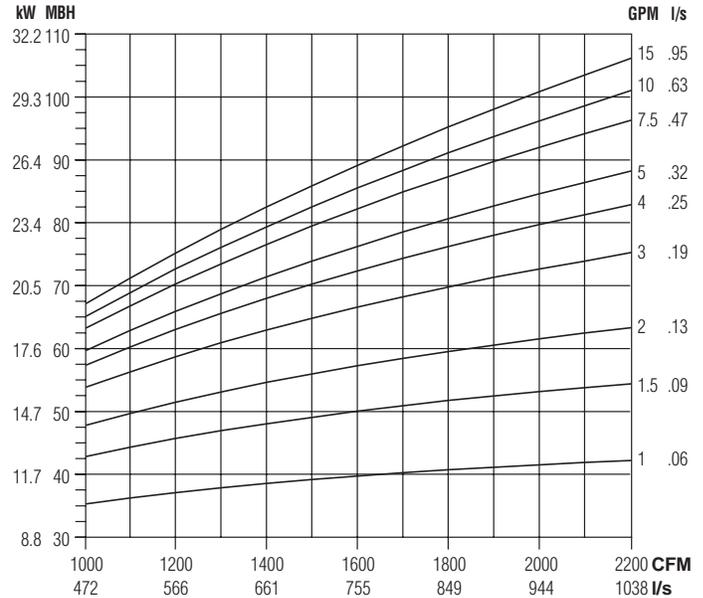

#### 3 Row (multi-circuit)

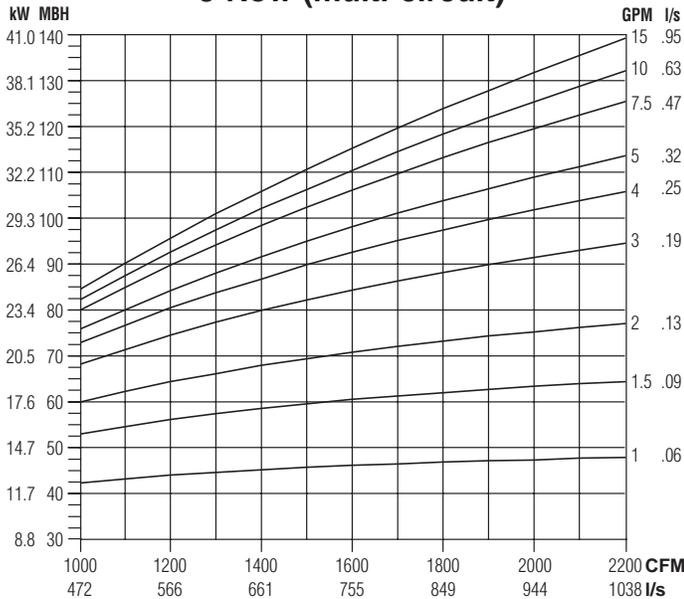

#### Water Pressure Drop

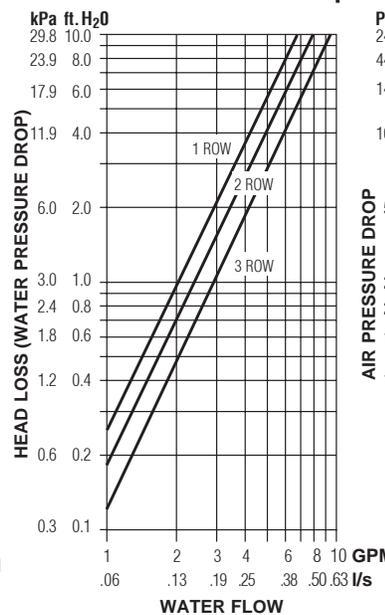

#### Air Pressure Drop

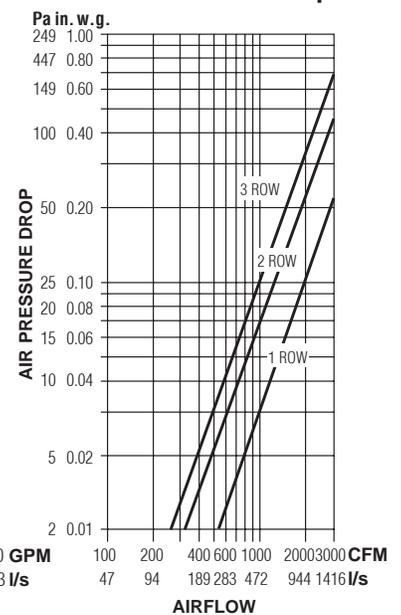

#### NOTES:

- Capacities are in MBH (kW), *thousands of Btu per hour (kiloWatts)*.
- MBH (kW) values are based on a  $\Delta t$  (temperature difference) of 110°F (61°C) between entering air and entering water. For other  $\Delta t$ 's; multiply the MBH (kW) values by the factors below.
- Air Temperature Rise.  
 $ATR (^\circ F) = 927 \times \frac{MBH}{cfm}$ ,  $ATR (^\circ C) = 829 \times \frac{kW}{l/s}$
- Water Temp. Drop.  
 $WTD (^\circ F) = 2.04 \times \frac{MBH}{GPM}$ ,  $WTD (^\circ C) = .224 \times \frac{kW}{l/s}$
- Connections: 1, 2 and 3 Row 7/8" (22); O.D. male solder.

#### Altitude Correction Factors:

Altitude ft. (m)	Sensible Heat Factor
0 (0)	1.00
2000 (610)	0.94
3000 (914)	0.90
4000 (1219)	0.87
5000 (1524)	0.84
6000 (1829)	0.81
7000 (2134)	0.78

#### Correction factors at other entering conditions:

$\Delta t$ °F (°C)	50 (28)	60 (33)	70 (39)	80 (44)	90 (50)	100 (56)	110 (61)	120 (67)	130 (72)	140 (78)	150 (83)
Factor	.455 (.459)	.545 (.541)	.636 (.639)	.727 (.721)	.818 (.820)	.909 (.918)	1.00 (1.00)	1.09 (1.10)	1.18 (1.18)	1.27 (1.28)	1.36 (1.36)

FAN POWERED TERMINAL UNITS

## Performance Data • Hot Water Coil

Models: 35SW, 35SWST, 35SW-OAI, 35SWST-OAI, 35SW-CVP • Series Flow

### Unit Size 7

#### 1 Row (multi-circuit)

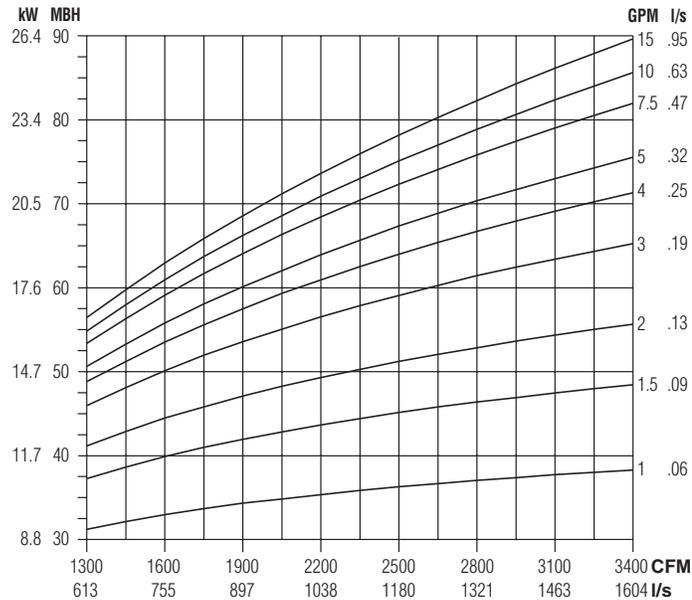

#### 2 Row (multi-circuit)

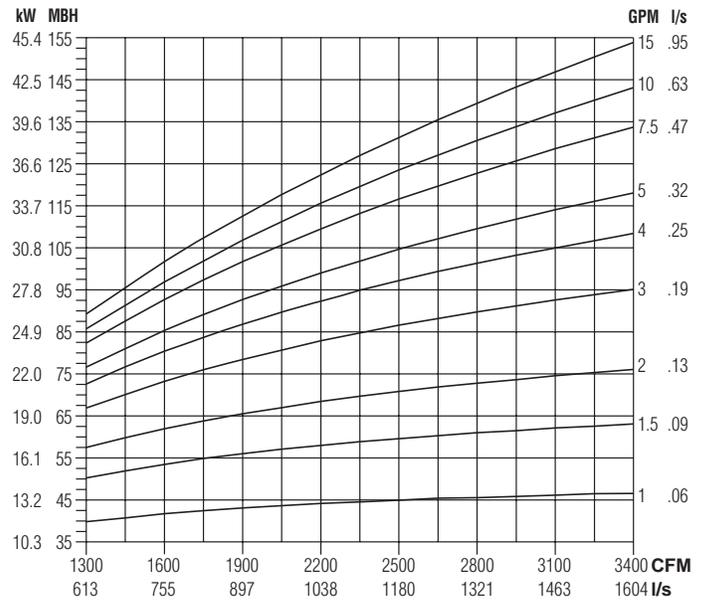

#### 3 Row (multi-circuit)

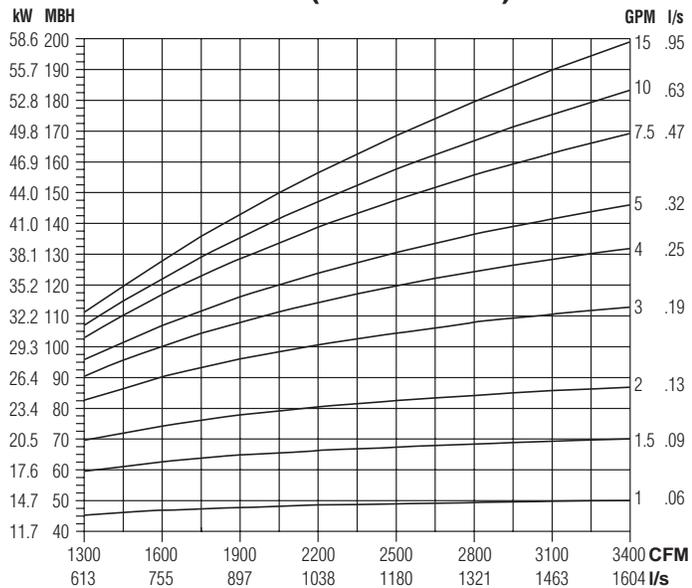

#### Water Pressure Drop

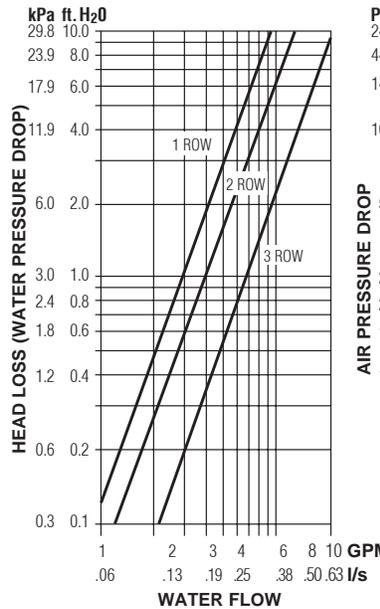

#### Air Pressure Drop

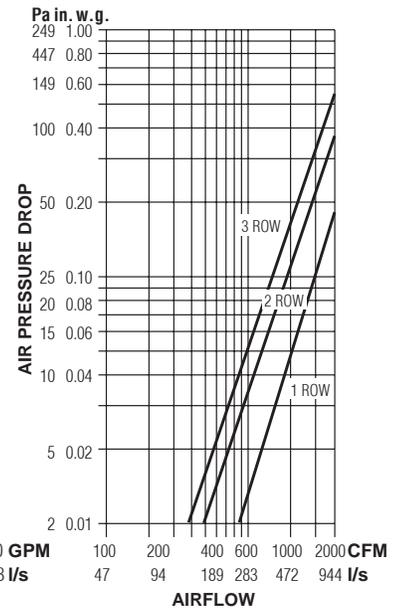

#### NOTES:

- Capacities are in MBH (kW), *thousands of Btu per hour (kiloWatts)*.
- MBH (kW) values are based on a  $\Delta t$  (temperature difference) of 110°F (61°C) between entering air and entering water. For other  $\Delta t$ 's; multiply the MBH (kW) values by the factors below.

- Air Temperature Rise.

$$\text{ATR (°F)} = 927 \times \frac{\text{MBH}}{\text{cfm}}, \quad \text{ATR (°C)} = 829 \times \frac{\text{kW}}{\text{l/s}}$$

- Water Temp. Drop.

$$\text{WTD (°F)} = 2.04 \times \frac{\text{MBH}}{\text{GPM}}, \quad \text{WTD (°C)} = .224 \times \frac{\text{kW}}{\text{l/s}}$$

- Connections: 1 and 2 Row 7/8" (22), 3 Row 1 3/8" (35); O.D. male solder.

#### Altitude Correction Factors:

Altitude ft. (m)	Sensible Heat Factor
0 (0)	1.00
2000 (610)	0.94
3000 (914)	0.90
4000 (1219)	0.87
5000 (1524)	0.84
6000 (1829)	0.81
7000 (2134)	0.78

#### Correction factors at other entering conditions:

$\Delta t$ °F (°C)	50 (28)	60 (33)	70 (39)	80 (44)	90 (50)	100 (56)	110 (61)	120 (67)	130 (72)	140 (78)	150 (83)
Factor	.455 (.459)	.545 (.541)	.636 (.639)	.727 (.721)	.818 (.820)	.909 (.918)	1.00 (1.00)	1.09 (1.10)	1.18 (1.18)	1.27 (1.28)	1.36 (1.36)

**SERIES FLOW  
CONSTANT OR  
VARIABLE VOLUME**

**37S SERIES**

- LOW PROFILE

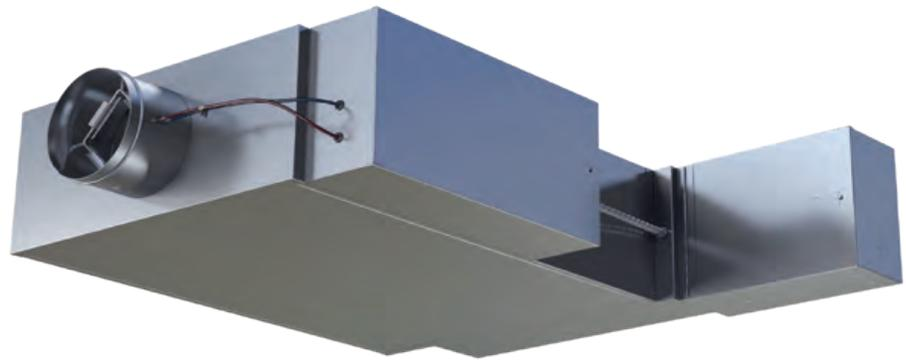

Model 37SE

**Models:**

- |             |                       |
|-------------|-----------------------|
| <b>37S</b>  | <b>No Heat</b>        |
| <b>37SE</b> | <b>Electric Heat</b>  |
| <b>37SW</b> | <b>Hot Water Heat</b> |

The **37S Series** Low Profile terminals are designed for shallow ceiling plenum applications and therefore limited to 11" (279) in height. Shallow plenums are common where zoning requirements limit building height. When building height is constrained, building designers will maximize the number of floors by reducing the distance between floors, requiring low profile products like the 37S Series.

**STANDARD FEATURES:**

- 20 ga. (1.0) galvanized steel construction.
- 16 ga. (1.61) galvanized steel inclined opposed blade primary air damper. 45° rotation, CW to close. 1/2" (13) dia. plated steel drive shaft. An indicator mark on the end of the shaft shows damper-position. Leakage is less than 2% of nominal flow at 3" w.g. (750 Pa).
- Perforated baffle on primary air discharge optimizes mixing with induced air for rapid and effective temperature equalization. The baffle also converts low frequency primary air valve generated sound into more readily attenuated higher frequencies.
- Pressure independent primary airflow control.
- Multi-point averaging Diamond flow sensor.
- Terminal is field flippable, providing left or right installation connections. Refer to IOM for details.
- Access panels are full size on top and bottom of terminal for ease of maintenance and service.
- Energy efficient PSC fan motor with thermal overload protection.
- Motor blower assembly mounted on special 16 ga. (1.61) angles and isolated from casing with rubber isolators.

- Adjustable PSC solid state fan speed controller with minimum voltage stop.
- Hinged door on fan controls enclosure.
- 1/2" (13), dual density insulation. Exposed edges coated to prevent air erosion. Meets requirements of NFPA 90A and UL 181.
- Available with electric or hot water supplementary heat.
- All controls are mounted on exterior of terminal providing ready access for field adjustment.
- Each terminal factory tested prior to shipment.
- Single point electrical and/or pneumatic main air connection.
- Discharge opening designed for flanged duct connection.
- Full primary air valve low voltage NEMA 1 type enclosure for factory mounted DDC and analog electronic controls.

**Controls:**

- Nailor EZvav
- Analog electronic and pneumatic controls. Factory supplied, mounted and calibrated.
- Digital controls. Factory mounting and wiring of DDC controls supplied by BMS Controls Contractor.

**Options:**

- ECM/EPIC Fan Technology®.
- Primary air valve enclosure for field mounted controls.
- Induced air filter, 1" (25) thick, disposable type.
- Toggle disconnect switch (except units with electric heat, when disconnect is an electric heat option and includes fan).
- Various IAQ linings are available.
- Fan airflow or P.E. switch for night shutdown (pneumatic controls).
- Fan airflow switch for night shutdown (analog electronic controls).
- Night setback fan/heat cycle (pneumatic and analog).
- Fan unit fusing.
- Hanger brackets.
- FN2 90° Line Voltage controls enclosure on model 37S and 37SW (standard on 37SE).
- FN3 Remote Line Voltage control enclosure.



**Intertek**

## Dimensions

### Model Series 37S • Low Profile • Series Flow • Unit Sizes 1 – 3

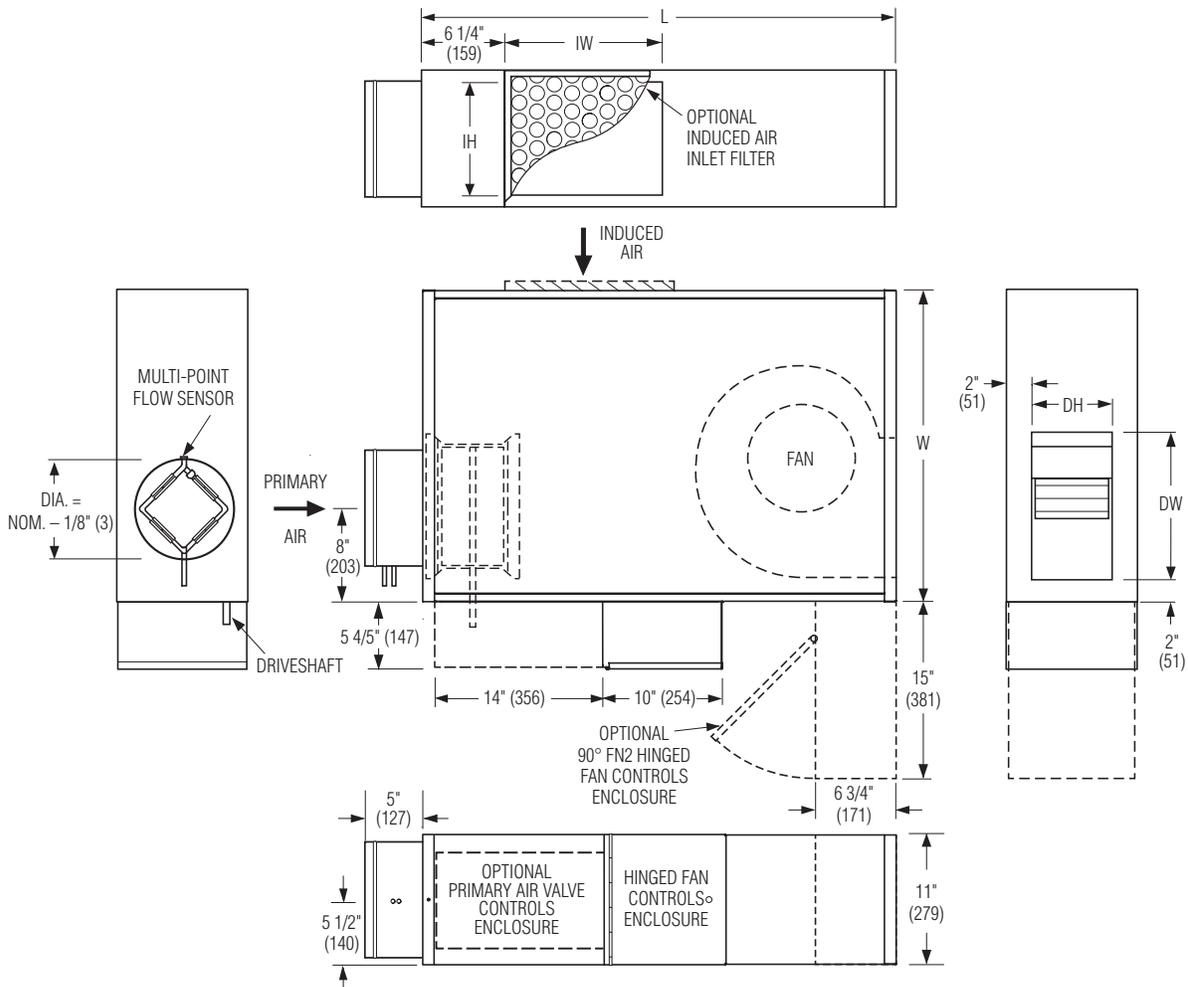

FAN POWERED TERMINAL UNITS

### Dimensional Data

Unit Size	Inlet Size	W	L	Induced Air Inlet IW x IH	Outlet Discharge DW x DH	Filter Size
1	4, 5, 6, 8 (102, 127, 152, 203)	19 (483)	36 (914)	6 x 8 (152 x 203)	10 3/8 x 6 7/8 (264 x 175)	8 x 10 (203 x 254)
2	6, 8, 10 (152, 203, 254)	26 1/2 (673)	40 1/4 (1022)	15 3/4 x 8 (400 x 203)	11 3/8 x 6 7/8 (289 x 175)	18 x 10 (457 x 254)
3	6, 8, 10 (152, 203, 254)	26 1/2 (673)	40 1/4 (1022)	15 3/4 x 8 (400 x 203)	12 3/8 x 6 7/8 (314 x 175)	18 x 10 (457 x 254)

## Dimensions

Model Series 37S • Low Profile • Series Flow • Unit Size 4

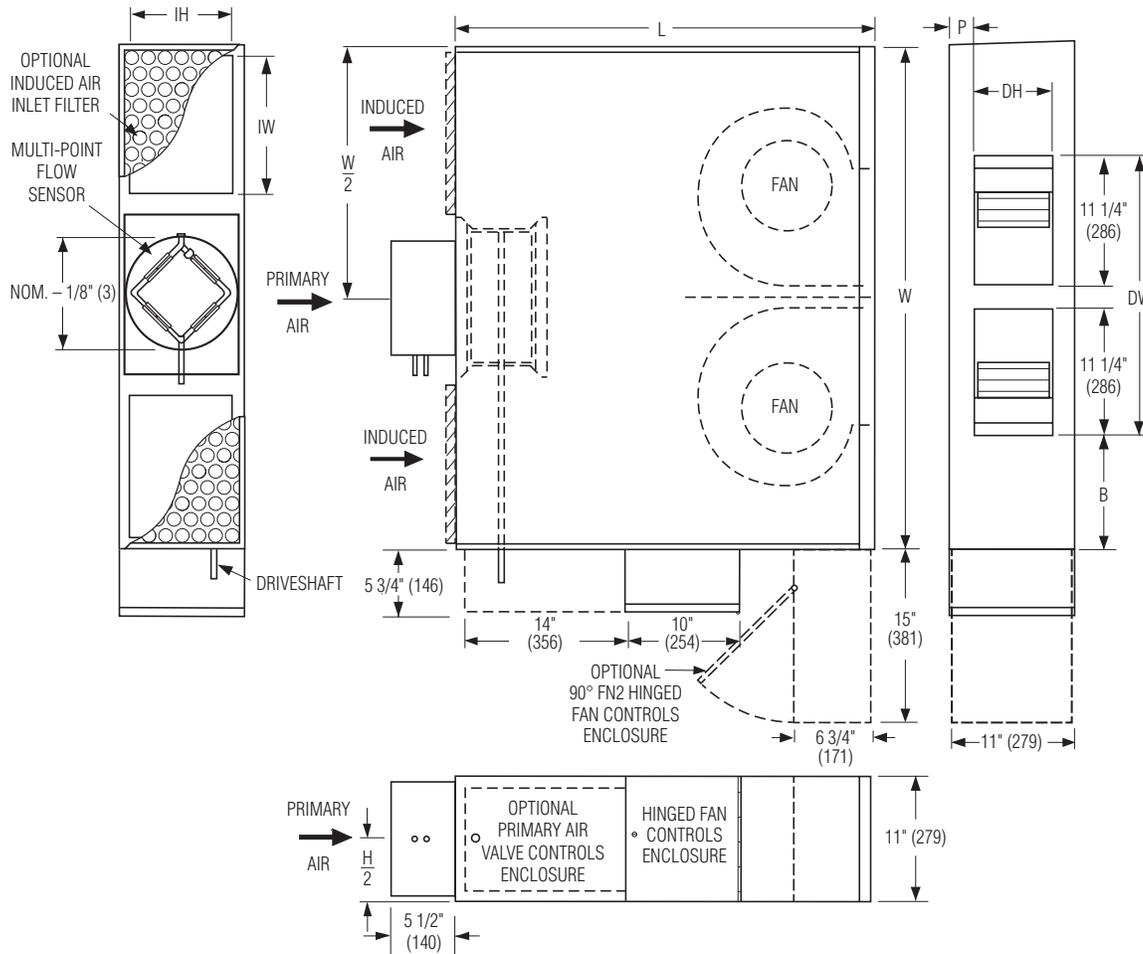

## Dimensional Data

Unit Size	Inlet Size	W	L	B	P	Induced Air Inlet IW x IH	Outlet Discharge DW x DH	Filter Size
4	10 (254) Round 14 x 10 (356 x 254) Rect.	44 (1118)	36 1/2 (927)	9 3/4 (248)	2 1/16 (52)	12 x 9 (305 x 229) Qty. of 2	24 1/2 x 6 7/8 (622 x 175)	14 x 10 (356 x 254) Qty. of 2

## Dimensions

### Model Series 37S • Low Profile • Series Flow

#### Hot Water Coil Section

#### Model 37SW

Available in one, two or three row. Coil section installed on unit discharge. Right hand coil connection looking in direction of airflow standard (shown). Left hand is optional.

#### Standard Features:

- Coil section installed on unit discharge.
- Coil (and header on multi-circuit units) is installed in insulated casing for increased thermal efficiency.
- 1/2" (13) copper tubes.
- Aluminum ripple fins.
- Sweat Connections:  
All size: 1 Row 1/2" (13), 2 and 3 Row 7/8" (22); O.D. male solder.
- Top and bottom access panels for inspection and coil cleaning.
- Flanged outlet duct connection.

#### Unit Sizes 1 – 3

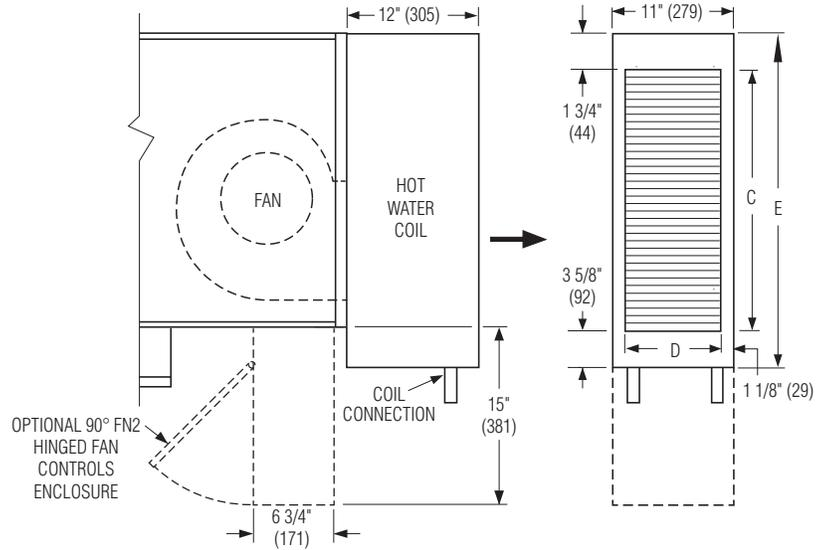

#### Unit Size 4

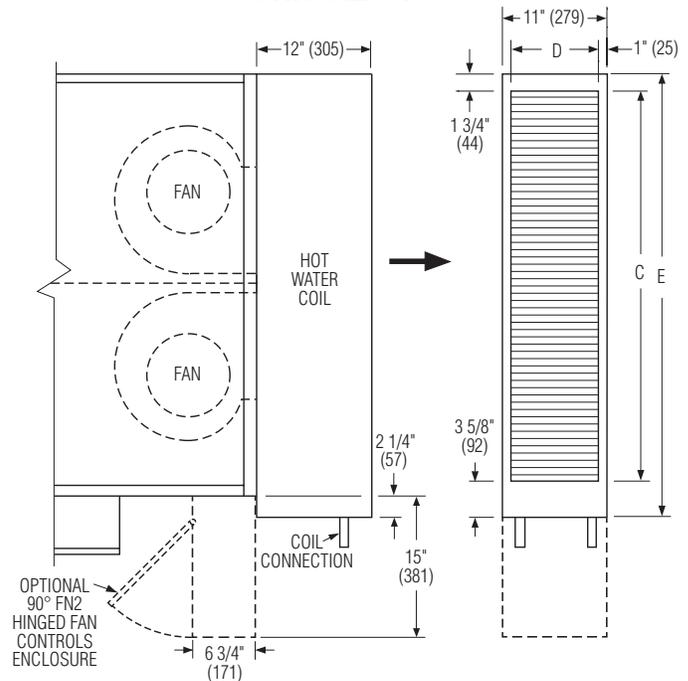

Unit Size	Outlet Duct Size C x D	E
1	14 5/8 x 8 3/4 (371 x 222)	20 (508)
2, 3	24 x 9 (610 x 229)	29 3/8 (746)
4	41 x 9 (1041 x 229)	46 3/8 (1178)

## Dimensions

### Model Series 37S • Low Profile • Series Flow

#### Electric Coil Section

#### Model 37SE

#### Standard Features:

- Controls enclosure incorporates a hinged access door opening upstream that helps ensure NEC clearance requirements and reduces footprint.
- Coil installed on unit discharge.
- Insulated coil element wrapper.
- Automatic reset high limit cut-outs (one per element).
- Single point electrical connection for entire terminal unit.
- Positive pressure airflow switch.
- Magnetic contactors per stage.
- Class A 80/20 Ni/Cr wire.
- Flanged outlet duct connection.
- Terminal unit with coil is ETL Listed as an assembly.
- Controls mounted as standard on RH side as shown. Terminals ordered with LH controls (optional) are inverted.

#### Standard Supply Voltage (60 Hz):

- Single phase: 120, 208, 240 & 277V.
- Three phase: 208, 480 (4 wire wye) and 600V (dual point connection).

#### Options:

- Toggle disconnect switch (includes fan).
- Door interlock disconnect switch.
- Mercury contactors.
- Power circuit fusing.
- Dust tight construction.
- Manual reset secondary thermal cut out.
- SCR Control.

#### Unit Sizes 1 – 3

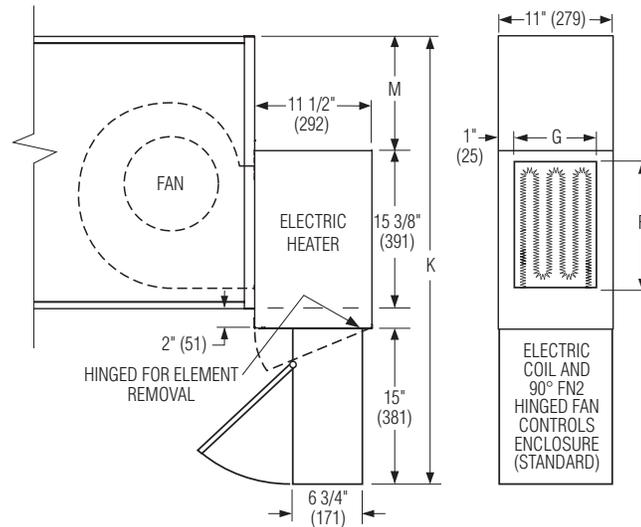

#### Unit Size 4

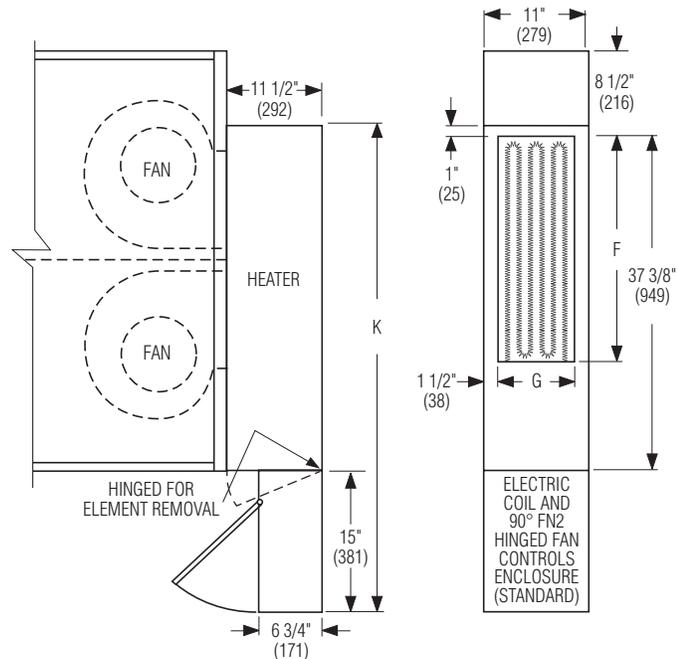

Unit Size	Outlet Duct Size F x G	M	K
1	12 3/8 x 9 (314 x 229)	3 5/8 (92)	35 7/8 (911)
2		11 1/8 (283)	43 1/2 (1105)
3		11 1/8 (283)	43 1/2 (1105)
4	25 x 8 (635 x 203)	—	52 3/8 (1330)

## Performance Data

### PSC Motor Fan Curves – Airflow vs. Downstream Static Pressure

#### 37S Series • Low Profile • Series Flow

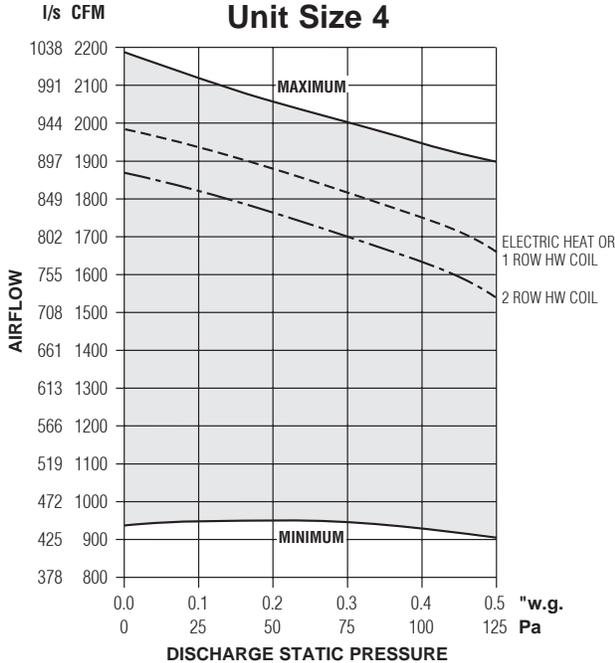
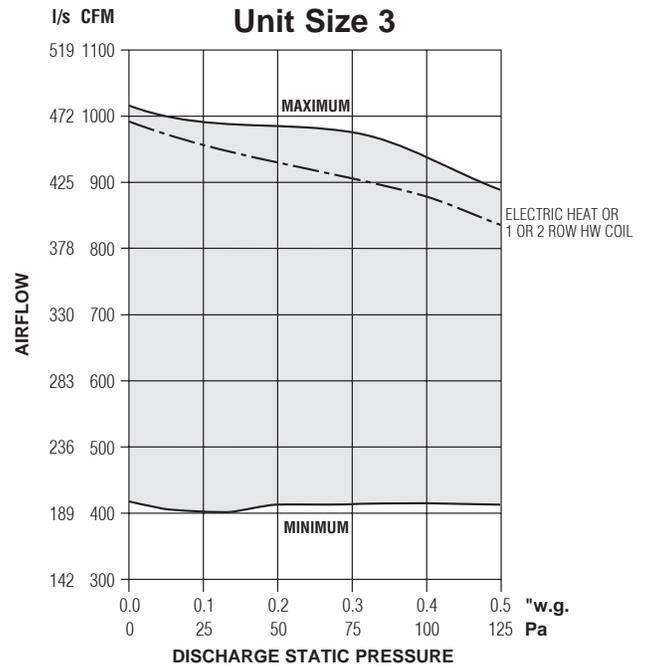
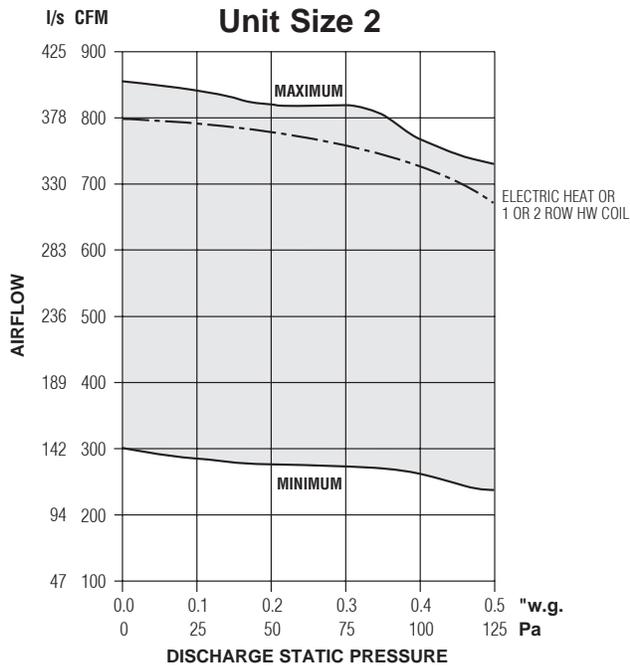

- Fan Curves shown are applicable to 120, 208, 240 and 277 volt, single phase PSC motors.

#### Electrical Data

Unit Size	PSC Motor HP	PSC Motor FLA			
		120V	208V	240V	277V
2	1/6	4.8	1.8	1.8	1.5
3	1/4	5.3	3.6	3.6	1.8
4	2@1/4	10.6	7.2	7.2	3.7

FLA = Full load amperage.  
All motors are single phase/60 Hz.

## Performance Data

### ECM Motor Fan Curves – Airflow vs. Downstream Static Pressure

#### 37S Series • Low Profile • Series Flow

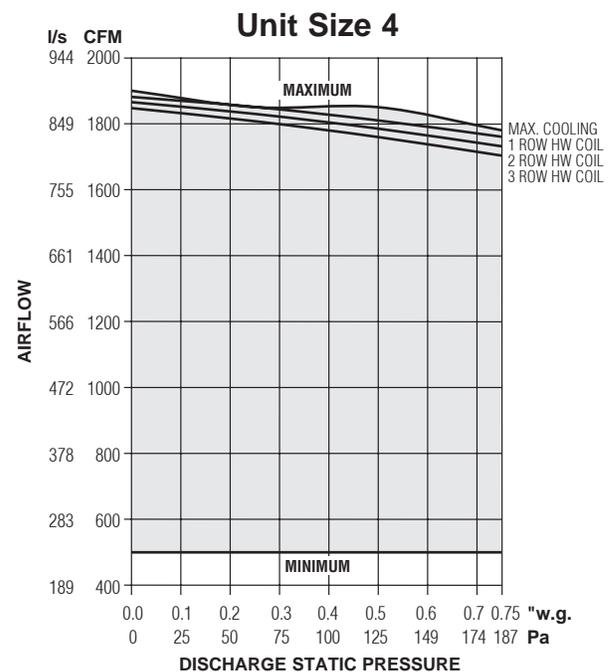
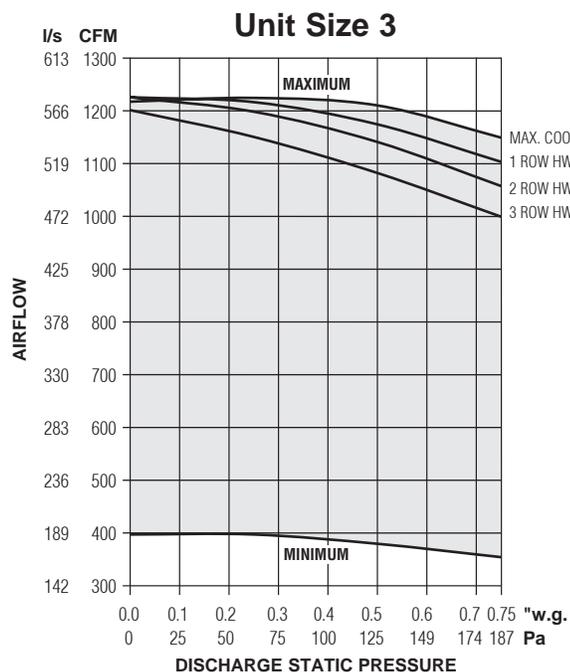
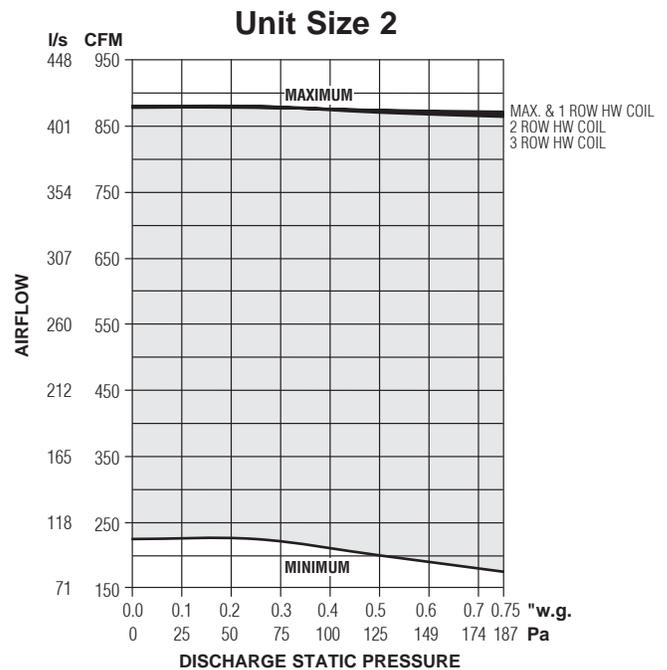
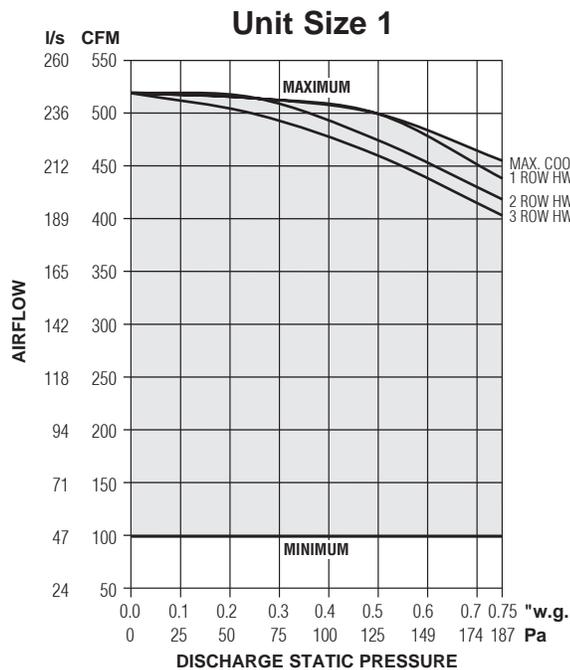

### Electrical Data

Unit Size	EPIC ECM Motor FLA				
	Motor HP	120V	208V	240V	277V
1	*	1.9	1.3	1.3	1.3
2	*	3.3	2.2	2.2	2.2
3	*	6.9	4.7	4.4	4.4
4	*	8.0	5.4	5.2	4.9

\* The EPIC ECM is a variable horsepower motor. Refer to Selectworks schedule for actual power consumption. FLA = Full load amperage. All motors are single phase/60 Hz.

### NOTES:

- The ECM is pressure independent and constant volume in operation at factory or field set point within the shaded area. Airflow does not vary with changing static pressure conditions. The motor compensates for any changes in external static pressure or induced air conditions such as filter loading.
- Airflow can be set to operate on horizontal performance line at any point within shaded area using the solid state volume controller provided.
- Fan curves shown are applicable to 120, 208, 240 and 277 volt, single phase ECM's. ECM's, although DC in operation, include a built-in inverter.

Performance Data • NC Level Application Guide

Model Series 37S • Low Profile • Series Flow

Fiberglass Liner

Unit Size	Inlet Size	Airflow		Min. inlet ΔPs		NC Levels @ Inlet Pressure (ΔPs) shown												
						DISCHARGE					RADIATED							
						Fan Only	Min. ΔPs	0.5" w.g. (125 Pa)	1.0" w.g. (250 Pa)	1.5" w.g. (375 Pa)	2.0" w.g. (500 Pa)	Fan Only	Min. ΔPs	0.5" w.g. (125 Pa)	1.0" w.g. (250 Pa)	1.5" w.g. (375 Pa)	2.0" w.g. (500 Pa)	
1	6	400	189	0.15	37	28	23	26	25	28	30	29	25	26	28	30	31	
		300	142	0.07	17	23	-	23	23	23	25	20	23	23	24	26	28	
		200	94	0.02	5	-	20	23	23	23	23	-	-	-	-	21	22	
		100	47	0.01	1	-	-	-	-	-	-	-	-	-	-	-	-	
	8	400	189	0.02	4	28	23	25	25	28	29	29	25	26	28	30	31	
		300	142	0.01	2	23	-	21	20	21	24	20	22	23	24	26	28	
		200	94	0.01	2	-	-	20	20	20	20	-	-	-	-	20	21	
		100	47	0.01	2	-	-	-	-	-	-	-	-	-	-	-	-	
2	6	550	260	0.21	52	-	-	-	-	20	23	25	25	26	28	30	31	
		400	189	0.08	20	-	-	-	-	-	-	22	22	23	24	26	29	
		275	130	0.01	2	-	-	-	-	-	-	-	20	21	22	25	29	
	8	800	378	0.11	27	28	24	23	21	24	24	31	30	30	31	33	34	
		700	330	0.08	19	24	23	20	21	23	25	29	28	28	30	31	34	
		550	260	0.04	10	-	-	-	-	-	21	25	24	25	28	29	30	
		400	189	0.02	4	-	-	-	-	-	-	22	22	23	24	25	28	
		275	130	0.01	2	-	-	-	-	-	-	-	20	21	22	24	28	
	10	800	378	0.03	7	28	24	21	21	23	24	31	30	30	31	33	34	
		700	330	0.02	4	24	21	-	20	23	23	29	28	28	29	31	34	
		550	260	0.01	2	-	-	-	-	-	20	25	24	25	26	29	30	
		400	189	0.01	2	-	-	-	-	-	-	22	21	22	23	25	27	
3	6	550	260	0.22	55	23	25	28	29	31	31	28	28	28	30	31	34	
		400	189	0.09	22	-	-	-	-	23	24	22	21	22	24	25	28	
	8	1100	519	0.15	37	35	35	35	36	35	36	35	38	36	38	38	38	
		900	425	0.09	22	31	31	31	33	33	33	31	34	34	34	34	35	
		650	307	0.04	10	23	23	25	26	28	29	28	26	28	29	31	34	
		400	189	0.01	2	-	-	-	-	20	21	22	21	21	23	25	28	
	10	1150	543	0.05	12	36	35	35	35	35	35	36	38	38	38	38	38	
		1100	519	0.05	12	35	35	34	35	35	35	35	38	36	38	38	38	
		900	425	0.04	9	31	31	30	31	31	33	31	34	34	34	34	35	
		650	307	0.02	4	23	21	23	24	25	26	28	26	26	29	31	34	
	4	10	1950	920	0.20	50	34	34	34	36	37	38	43	39	40	41	44	45
			1800	849	0.17	42	33	31	33	35	36	37	40	38	39	40	43	44
1450			684	0.12	29	26	26	28	31	33	34	36	35	37	39	40	43	
1100			519	0.08	19	20	20	24	28	29	29	31	31	33	35	37	39	
800			378	0.05	11	-	-	-	-	20	20	28	26	29	32	34	36	
14 x 10		1950	920	0.13	32	34	33	33	35	36	37	43	39	40	41	44	45	
		1800	849	0.12	30	33	31	31	34	35	36	40	38	39	40	43	44	
		1450	684	0.08	20	26	25	26	30	31	33	36	34	36	38	40	41	
		1100	519	0.05	11	20	-	23	25	26	28	31	31	32	34	37	38	
		800	378	0.03	7	-	-	-	-	-	-	28	26	29	31	34	36	

Performance Notes:

1. NC Levels are calculated based on procedures as outlined on page C160.
2. Dash (-) in space indicates a NC less than 20.

FAN POWERED TERMINAL UNITS

## Performance Data • Discharge Sound Power Levels

Model Series 37S • Low Profile • Series Flow • Basic Unit

Fiberglass Liner



Unit Size	Inlet Size	Airflow		Min. inlet ΔPs		Fan Only		Fan and 100% Primary Air – Sound Power Octave Bands @ Inlet pressure (ΔPs) shown																																		
		cfm	l/s	"w.g.	Pa	Minimum ΔPs							0.5" w.g. (125Pa) ΔPs							1.0" w.g. (249Pa) ΔPs							1.5" w.g. (375Pa) ΔPs							2.0" w.g. (500Pa) ΔPs								
						2	3	4	5	6	7	2	3	4	5	6	7	2	3	4	5	6	7	2	3	4	5	6	7	2	3	4	5	6	7							
1	6	400	189	0.15	37	73	68	63	60	57	54	69	63	58	51	47	45	72	66	60	54	51	48	71	65	57	50	46	43	73	68	60	54	51	47	74	70	63	55	52	48	
		300	142	0.07	17	69	63	58	54	50	46	65	57	52	44	39	36	69	61	55	49	44	39	69	61	52	44	38	34	69	64	56	47	41	36	70	66	59	49	43	38	
		200	94	0.02	5	62	54	50	44	38	30	64	52	44	36	30	25	66	54	45	36	29	23	66	58	48	36	26	21	66	59	52	37	27	21	66	60	54	39	29	23	
		100	47	0.01	1	56	48	44	37	29	-	60	46	37	29	22	-	62	49	37	28	-	-	63	55	43	28	-	-	61	55	47	29	-	-	62	55	50	32	-	-	
	8	400	189	0.02	4	<b>73</b>	<b>68</b>	<b>63</b>	<b>60</b>	<b>57</b>	<b>54</b>	69	63	57	51	47	45	71	65	60	54	51	48	71	64	57	50	46	43	72	68	60	54	51	47	73	69	62	55	52	48	
		300	142	0.01	2	69	63	58	54	50	46	64	56	51	44	39	36	68	61	55	48	44	39	67	60	52	44	38	34	68	63	55	46	41	36	69	65	58	48	43	38	
		200	94	0.01	2	62	54	50	44	38	30	62	51	43	36	30	25	64	53	44	36	29	23	64	57	47	35	26	21	64	58	51	37	27	21	64	59	53	39	29	23	
		100	47	0.01	2	56	48	44	37	29	-	58	45	37	29	22	-	61	47	36	28	-	-	61	54	43	28	-	-	60	54	46	28	-	-	60	53	49	31	-	-	
2	6	550	260	0.21	52	63	61	58	56	52	47	65	60	58	54	49	43	63	58	57	52	47	41	66	60	58	53	48	41	67	62	58	53	48	41	69	62	59	53	48	41	
		400	189	0.08	20	59	56	54	51	47	39	62	57	56	51	45	36	62	56	55	49	43	34	63	58	55	49	43	34	65	59	56	49	43	34	65	59	56	49	43	34	
		275	130	0.01	2	56	51	50	46	40	30	61	53	51	46	40	29	60	53	50	44	37	26	60	54	51	44	37	24	63	56	52	44	37	25	62	56	52	44	37	26	
		800	378	0.11	27	71	69	66	63	60	58	68	66	62	58	55	51	67	65	61	57	53	50	68	64	61	57	53	49	70	66	61	57	53	50	70	66	62	58	54	50	
	8	700	330	0.08	19	67	65	62	60	56	53	67	64	61	57	53	48	66	62	59	55	51	47	67	63	60	56	51	47	69	64	60	56	51	47	71	65	61	56	52	47	
		550	260	0.04	10	63	61	58	56	52	47	64	60	58	54	49	43	62	58	56	52	47	41	64	60	57	53	48	41	66	61	58	53	48	41	68	62	58	53	48	41	
		400	189	0.02	4	59	56	54	51	47	39	60	55	55	50	45	36	60	55	54	49	43	34	61	56	54	49	43	34	63	58	55	48	43	34	63	58	55	49	43	34	
		275	130	0.01	2	56	51	50	46	40	30	59	52	50	45	39	28	58	52	49	44	37	25	58	53	50	43	36	24	62	54	51	43	36	25	60	54	51	44	36	25	
	10	800	378	0.03	7	<b>71</b>	<b>69</b>	<b>66</b>	<b>63</b>	<b>60</b>	<b>58</b>	68	66	61	58	55	51	67	64	60	57	53	50	67	64	60	57	53	49	69	65	61	57	53	50	70	66	61	58	54	50	
		700	330	0.02	4	67	65	62	60	56	53	66	63	60	57	53	48	65	61	59	55	51	47	66	62	59	55	51	47	68	64	60	56	51	47	69	64	60	56	52	47	
		550	260	0.01	2	63	61	58	56	52	47	62	59	57	53	49	43	61	57	56	51	47	41	63	59	57	52	48	41	65	61	57	52	48	41	67	61	57	52	48	41	
		400	189	0.01	2	59	56	54	51	47	39	59	54	54	50	45	36	58	54	53	48	43	34	60	55	53	48	43	34	61	56	54	48	43	34	61	57	54	48	43	34	
	275	130	0.01	2	56	51	50	46	40	30	57	50	49	45	39	28	56	50	48	43	37	25	56	51	49	43	36	24	60	52	50	43	36	24	58	52	50	43	36	25		
	3	6	550	260	0.22	55	69	63	60	59	55	51	71	65	61	58	53	49	73	66	62	59	54	50	74	67	62	59	54	50	76	68	63	59	55	50	76	68	63	59	55	50
			400	189	0.09	22	62	57	55	52	47	42	64	59	57	52	48	42	63	59	56	52	47	41	66	61	56	52	47	41	69	63	57	52	48	42	70	63	58	52	48	42
			1100	519	0.15	37	78	75	70	70	68	65	78	75	69	68	66	63	78	75	69	68	66	63	79	76	70	68	66	63	80	75	70	68	66	63	80	76	70	68	66	63
900			425	0.09	22	75	72	68	67	64	61	76	72	67	66	63	60	76	72	66	66	63	60	77	73	67	66	63	60	79	73	67	66	63	60	79	73	68	66	63	60	
8		650	307	0.04	10	69	63	60	59	55	51	69	64	60	58	53	49	71	65	61	58	54	50	72	65	61	58	54	50	73	67	61	58	55	50	74	67	62	59	55	50	
		400	189	0.01	2	62	57	55	52	47	42	62	58	56	52	47	41	62	58	55	51	47	40	64	59	55	51	47	40	67	61	56	51	47	41	68	62	57	52	48	42	
		1150	543	0.05	12	78	76	71	70	68	65	77	75	69	68	66	64	78	75	69	68	66	63	78	75	69	68	66	63	79	75	70	68	66	63	79	75	70	68	66	63	
		1100	519	0.05	12	<b>78</b>	<b>75</b>	<b>70</b>	<b>70</b>	<b>68</b>	<b>65</b>	77	75	69	68	66	63	77	74	68	68	66	63	78	75	69	68	66	63	79	75	69	68	66	63	79	75	69	68	66	63	
10		900	425	0.04	9	75	72	68	67	64	61	74	72	66	65	63	60	75	71	66	65	63	60	76	72	66	65	63	60	77	72	67	65	63	60	77	73	67	65	63	60	
		650	307	0.02	4	69	63	60	59	55	51	67	63	59	57	53	49	69	63	59	57	54	50	70	64	60	57	54	50	71	65	60	58	55	50	72	66	61	58	55	50	
		400	189	0.01	1	62	57	55	52	47	42	60	56	54	51	47	41	60	56	54	51	46	40	62	57	54	51	46	40	65	59	55	51	47	41	66	60	56	51	47	41	
		1950	920	0.20	50	79	74	73	74	71	69	77	74	73	72	70	67	77	74	73	73	71	68	79	76	75	74	72	69	80	77	76	75	72	70	81	78	76	75	73	70	
4	10	1800	849	0.17	42	77	73	72	72	70	67	76	72	71	71	68	66	76	73	72	72	69	67	78	75	73	73	70	68	79	76	75	73	71	69	80	77	75	74	71	69	
		1450	684	0.12	29	73	68	68	68	65	62	73	68	68	68	64	61	74	69	69	69	65	62	76	72	70	70	66	64	77	73	72	71	67	64	77	74	72	71	68	65	
		1100	519	0.08	19	67	63	64	62	59	55	67	63	64	62	58	55	71	66	66	65	61	57	73	69	68	66	62	59	74	70	69	67	63	60	74	70	69	67	63	60	
		800	378	0.05	11	62	57	59	57	54	48	62	57	60	57	53	47	65	60	61	59	55	49	66	62	62	60	56	51	68	63	63	61	56	51	68	63	63	61	57	52	
	14 x 10	1950	920	0.13	32	79	74	73	74	71	69	76	73	72	72	70	67	77	73	73	73	71	68	78	75	74	74	72	69	80	76	75	75	72	70	80	77	76	75	73	70	
		1800	849	0.12	30	<b>77</b>	<b>73</b>	<b>72</b>	<b>72</b>	<b>70</b>	<b>67</b>	75	72	71	71	68	66	76	72	72	72	69	67	77	74	73	73	70	68	78	75	74	73	71	69	79	76	74	74	71	69	
		1450	684	0.08</																																						

Performance Data • Radiated Sound Power Levels

Model Series 37S • Low Profile • Series Flow • Basic Unit

Fiberglass Liner



Unit Size	Inlet Size	Airflow		Min. inlet ΔPs		Fan Only		Fan and 100% Primary Air – Sound Power Octave Bands @ Inlet pressure (ΔPs) shown																																	
								Minimum ΔPs					0.5" w.g. (125Pa) ΔPs					1.0" w.g. (249Pa) ΔPs					1.5" w.g. (375Pa) ΔPs					2.0" w.g. (500Pa) ΔPs													
								2	3	4	5	6	7	2	3	4	5	6	7	2	3	4	5	6	7	2	3	4	5	6	7	2	3	4	5	6	7				
1	6	400	189	0.15	37	65	59	54	52	44	37	62	56	51	49	41	33	62	57	51	49	45	42	63	58	52	51	49	47	64	60	53	53	52	53	65	61	54	54	54	56
		300	142	0.07	17	56	50	46	43	34	26	58	53	49	45	37	30	59	53	49	46	43	40	60	55	50	48	46	44	60	57	51	50	49	49	61	58	52	51	51	52
		200	94	0.02	5	49	45	43	39	29	20	50	44	42	39	28	19	51	46	42	41	37	34	52	49	44	44	40	39	53	51	47	46	44	44	54	53	48	48	46	47
		100	47	0.01	1	-	41	39	35	24	-	-	39	38	35	24	-	-	42	39	37	29	26	-	43	40	39	33	31	-	43	40	41	38	37	-	43	41	42	41	41
	8	400	189	0.02	4	65	59	54	52	44	37	62	56	51	48	40	33	62	57	51	49	45	41	63	58	52	51	48	47	64	60	53	52	52	52	65	61	54	53	54	56
		300	142	0.01	2	56	50	46	43	34	26	58	53	48	45	36	29	59	53	49	46	42	39	60	55	50	48	45	44	60	57	51	49	48	48	61	58	52	50	51	51
		200	94	0.01	2	49	45	43	39	29	20	50	44	42	38	28	19	51	46	42	41	36	33	52	49	44	43	40	38	53	51	46	45	43	43	54	53	47	47	45	46
		100	47	0.01	2	-	41	39	35	24	-	-	39	38	34	23	-	-	42	39	36	29	25	-	42	39	38	33	30	-	43	40	40	37	36	-	43	41	41	39	39
2	6	550	260	0.21	52	59	52	51	51	41	32	56	51	51	51	40	33	57	52	52	51	45	46	59	55	53	53	49	51	62	58	55	55	54	56	63	60	56	57	57	60
		400	189	0.08	20	53	49	48	47	36	26	51	49	48	48	36	28	54	49	49	50	44	45	56	52	50	52	49	50	58	54	52	54	55	55	59	56	53	56	59	59
		275	130	0.01	2	49	47	45	44	33	22	49	47	46	44	33	22	52	48	47	48	43	39	53	50	48	49	49	47	54	52	49	51	55	55	55	54	50	52	59	61
	8	800	378	0.11	27	67	60	56	56	48	40	63	58	55	56	46	38	64	58	55	56	48	47	65	60	56	57	52	53	66	62	57	59	55	58	66	63	58	60	60	61
		700	330	0.08	19	64	57	54	54	45	37	60	55	53	54	43	36	61	56	53	55	46	47	62	59	55	56	51	52	64	61	56	57	55	57	65	63	57	57	57	61
		550	260	0.04	10	59	52	51	51	41	32	56	51	50	51	39	33	57	52	51	51	44	45	59	55	53	53	49	50	62	58	54	55	54	55	63	60	55	56	57	59
		400	189	0.02	4	53	49	48	47	36	26	51	49	48	47	36	27	54	49	49	49	43	43	56	52	50	51	48	48	58	54	51	53	54	54	59	56	53	54	58	57
	275	130	0.01	2	49	47	45	44	33	22	49	46	46	43	32	22	52	48	47	47	42	38	53	50	48	48	48	46	54	52	49	50	54	54	54	53	49	51	58	59	
	10	800	378	0.03	7	67	60	56	56	48	40	63	58	55	55	46	38	64	58	55	55	48	47	65	60	56	57	51	52	66	62	57	58	54	57	66	63	58	59	59	61
		700	330	0.02	4	64	57	54	54	45	37	60	55	53	53	43	35	61	56	53	54	46	46	62	59	54	55	50	51	64	61	56	56	54	56	65	63	57	57	57	60
		550	260	0.01	2	59	52	51	51	41	32	56	51	50	50	39	32	57	52	51	50	44	44	59	55	52	52	49	49	62	58	54	54	53	54	63	60	55	55	56	58
		400	189	0.01	2	53	49	48	47	36	26	51	49	47	46	35	26	54	49	48	48	42	42	56	52	49	50	48	47	58	54	51	52	53	52	59	56	52	53	57	56
275		130	0.01	2	49	47	45	44	33	22	48	46	45	42	31	21	51	48	46	46	41	37	52	49	47	48	47	45	53	51	48	49	52	52	54	53	49	50	56	57	
3	6	550	260	0.22	55	63	54	53	52	43	34	62	54	53	53	43	34	62	55	53	53	46	48	63	58	55	55	50	53	65	61	56	56	54	58	65	63	57	57	57	62
		400	189	0.09	22	54	49	48	46	37	27	53	48	47	45	35	23	55	50	48	47	43	43	57	53	50	49	48	60	56	51	51	52	54	61	58	53	52	55	58	
	8	1100	519	0.15	37	70	63	59	59	52	44	72	65	59	61	54	50	71	65	60	60	54	50	72	65	60	61	55	54	72	66	61	62	56	59	70	67	62	63	57	62
		900	425	0.09	22	67	59	56	56	49	40	69	61	57	57	48	39	69	61	57	57	50	49	69	62	58	58	52	53	69	63	59	59	54	58	70	64	60	59	55	62
		650	307	0.04	10	63	54	53	52	43	34	62	54	52	52	42	33	62	55	53	52	45	46	63	58	54	54	49	51	65	61	55	55	53	57	65	63	56	56	56	60
	400	189	0.01	2	54	49	48	46	37	27	53	47	47	45	34	22	54	49	47	46	42	41	57	52	49	48	46	47	59	56	51	50	51	52	61	58	52	51	54	56	
	10	1150	543	0.05	12	71	64	60	60	53	45	72	65	60	61	54	46	72	65	60	57	51	47	72	66	61	61	54	54	72	66	61	62	56	58	72	67	62	62	56	61
		1100	519	0.05	12	70	63	59	59	52	44	72	65	59	60	53	50	71	65	60	60	53	49	72	65	60	61	54	54	72	66	61	61	55	58	72	67	62	62	56	61
		900	425	0.04	9	67	59	56	56	49	40	69	61	56	56	48	39	69	61	57	57	49	48	69	62	58	57	51	52	69	63	59	58	53	57	70	64	59	59	55	60
		650	307	0.02	4	63	54	53	52	43	34	62	54	52	51	41	32	62	55	52	51	45	45	63	58	54	53	48	50	65	61	55	54	52	55	65	63	56	55	55	58
400		189	0.01	1	54	49	48	46	37	27	52	47	46	44	33	22	54	49	47	45	41	40	56	52	49	47	45	45	58	55	50	49	49	51	60	57	52	50	52	54	
4	10	1950	920	0.20	50	76	69	65	63	54	46	73	68	64	62	53	45	73	68	65	63	54	48	74	70	66	64	57	53	75	71	68	66	60	58	76	72	69	67	62	62
		1800	849	0.17	42	74	67	64	61	52	44	72	66	63	60	51	43	72	67	64	61	53	47	73	69	65	63	56	53	74	70	67	65	60	58	75	72	68	66	62	62
		1450	684	0.12	29	71	63	61	57	47	39	68	62	60	57	46	38	69	64	62	58	50	45	70	66	64	60	54	52	71	67	65	62	59	59	72	69	67	64	62	64
		1100	519	0.08	19	64	58	56	52	41	32	64	58	56	52	41	32	63	59	58	55	48	44	65	62	60	57	54	51	67	65	62	60	59	59	69	66	64	62	63	65
		800	378	0.05	11	60	54	53	48	36	26	56	53	52	47	35	24	59	55	54	51	48	42	61	58	57	54	51	63	61	59	57	60	59	65	63	61	59	64	65	
	14 x 10	1950	920	0.13	32	76	69	65	63	54	46	73	68	64	61	52	44	73	68	65	62	54	48	74	70	66	64	57	53	75	71	68	65	59	58	76	72	69	66	61	61
		1800	849	0.12	30	74	67	64	61	52	44	72	66	63	60	50	42	72	67	64	61	53	47	73	69	65	62	56	52	74	70	67	64	59	58	75	72	68	65	61	62
		1450	684	0.08	20	71	63	61	57	47	39	68	62	59	56	46	37	69	64	61	58																				

## Performance Data • AHRI Certification and Performance Notes

### Model Series 37S • Low Profile • Series Flow • Basic Unit • AHRI Certification Rating Points Fiberglass Liner

Unit Size	Inlet Size	Fan Airflow		Fan <sup>Σ</sup> Watts	Fan Only* @ .25" w.g. (62 Pa) ΔPs												Primary Airflow		Min. Inlet ΔPs		Fan + 100% Primary @ 1.5" w.g. (375 Pa) ΔPs w/ .25" w.g. (62 Pa) Discharge ΔPs						
					Discharge						Radiated										Radiated						
					2	3	4	5	6	7	2	3	4	5	6	7					2	3	4	5	6	7	
1	8	400	189	140	73	68	63	60	57	54	65	59	54	52	44	37	400	189	0.02	4	64	60	53	52	52	52	
2	10	800	378	170	71	69	66	63	60	58	67	60	56	56	48	40	800	378	0.03	7	66	62	57	58	54	57	
3	10	1100	519	400	78	75	70	70	68	65	70	63	59	59	52	44	1100	519	0.05	12	72	66	61	61	55	58	
4	14 x 10	1800	849	600	77	73	72	72	70	67	74	67	64	61	52	44	1800	849	0.12	30	74	70	67	64	59	58	

<sup>Σ</sup> Motor = ECM.

\* Primary air valve is closed and therefore primary cfm is zero.



Ratings are certified in accordance with AHRI Standards.

#### Performance Notes for Sound Power Levels:

- Discharge (external) static pressure is 0.25" w.g. (63 Pa) in all cases, which is the difference (ΔPs) in static pressure from terminal discharge to the room.  
Discharge Sound Power Levels (SWL) now include duct end reflection energy as part of the standard rating. Including the duct end correction provides sound power levels that would normally be transmitted into an acoustically, non-reflective duct. The effect of including the energy correction to the discharge SWL, is higher sound power levels when compared to previous AHRI certified data. For more information on duct end reflection calculations see AHRI Standard 880.
- Radiated sound power is the breakout noise transmitted through the unit casing walls.
- Sound power levels are in decibels, dB re 10<sup>-12</sup> watts.

- All sound data listed by octave bands is raw data without any corrections for room absorption or duct attenuation. Dash (-) in space indicates sound power level is less than 20 dB or equal to background.
- Min. inlet ΔPs is the minimum operating pressure of the primary air valve section.
- Asterisk (\*) in space indicates that the minimum inlet static pressure requirement is greater than 0.5" w.g. (125 Pa) at rated airflow.
- Data derived from independent tests conducted in accordance with ANSI / ASHRAE Standard 130 and AHRI Standard 880.

**SERIES FLOW  
CONSTANT OR  
VARIABLE VOLUME**

**37SST STEALTH™ SERIES**

- LOW PROFILE
- QUIET OPERATION

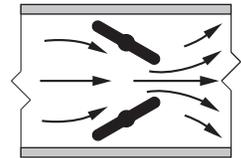

Inclined opposed blade damper configuration minimizes noisy turbulence and provides smooth, accurate, near linear flow control.



**Model 37SWST**

**Models:**

- 37SST**     No Heat
- 37SEST**    Electric Heat
- 37SWST**    Hot Water Heat

The **37SST Stealth™** Series are only 11" (279) high and have been specifically designed for shallow ceiling plenum applications, which are common where zoning requirements limit building height and the architect wishes to maximize the number of floors. Utilizing Stealth™ design technology, this terminal has industry leading low sound levels.

**STANDARD FEATURES:**

- 20 ga. (1.0) galvanized steel construction.
- 16 ga. (1.61) galvanized steel inclined opposed blade primary air damper. 45° rotation, CW to close. 1/2" (13) dia. plated steel drive shaft. An indicator mark on the end of the shaft shows damper-position. Leakage is less than 2% of nominal flow at 3" w.g. (750 Pa).
- Stealth™ design technology provides significant reductions in radiated sound levels.
- Perforated baffle on primary air discharge optimizes mixing with induced air for rapid and effective temperature equalization. The baffle also converts low frequency primary air valve generated sound into more readily attenuated higher frequencies.
- Pressure independent primary airflow control.
- Multi-point averaging Diamond Flow sensor.
- Terminal may be field installed either way up, providing the additional flexibility of right or left field connections.
- Access panels are full size on top and bottom of terminal for ease of maintenance and service.
- Energy efficient PSC fan motor with thermal overload protection.
- Motor blower assembly mounted

- on special 16 ga. (1.61) angles and isolated from casing with rubber isolators.
- Adjustable PSC solid state fan speed controller with minimum voltage stop.
- Hinged door on fan controls enclosure.
- 1/2" (13), dual density insulation. Exposed edges coated to prevent air erosion. Meets requirements of NFPA 90A and UL 181.
- Available with electric or hot water supplementary heat.
- All controls are mounted on exterior of terminal providing ready access for field adjustment.
- Each terminal factory tested prior to shipment.
- Single point electrical and/or pneumatic main air connection.
- Discharge opening designed for flanged duct connection.
- Full primary air valve low voltage NEMA 1 type enclosure for factory mounted DDC and analog electronic controls.

**Controls:**

- Nailor EZvav
- Analog electronic and pneumatic controls. Factory supplied, mounted and calibrated.
- Digital controls. Factory mounting and wiring of DDC controls supplied by BMS Controls Contractor.

**Options:**

- ECM/EPIC Fan Technology®.
- Primary air valve controls enclosure for field mounted controls.
- Induced air filter, 1" (25) thick, disposable type.
- Toggle disconnect switch (except units with electric heat, when disconnect is an electric heat option and includes fan).
- Various IAQ linings are available.
- Fan airflow or P.E. switch for night shutdown (pneumatic controls).
- Fan airflow switch for night shutdown (analog electronic controls).
- Night setback fan/heat cycle (pneumatic and analog).
- Fan unit fusing.
- Hanger brackets.
- FN2 90° Line Voltage controls enclosure on model 37SST and 37SWST (standard on 37SEST).
- FN3 Remote Line Voltage control enclosure.



## Dimensions

### Model Series 37SST Stealth™ • Low Profile • Unit Sizes 1 – 3

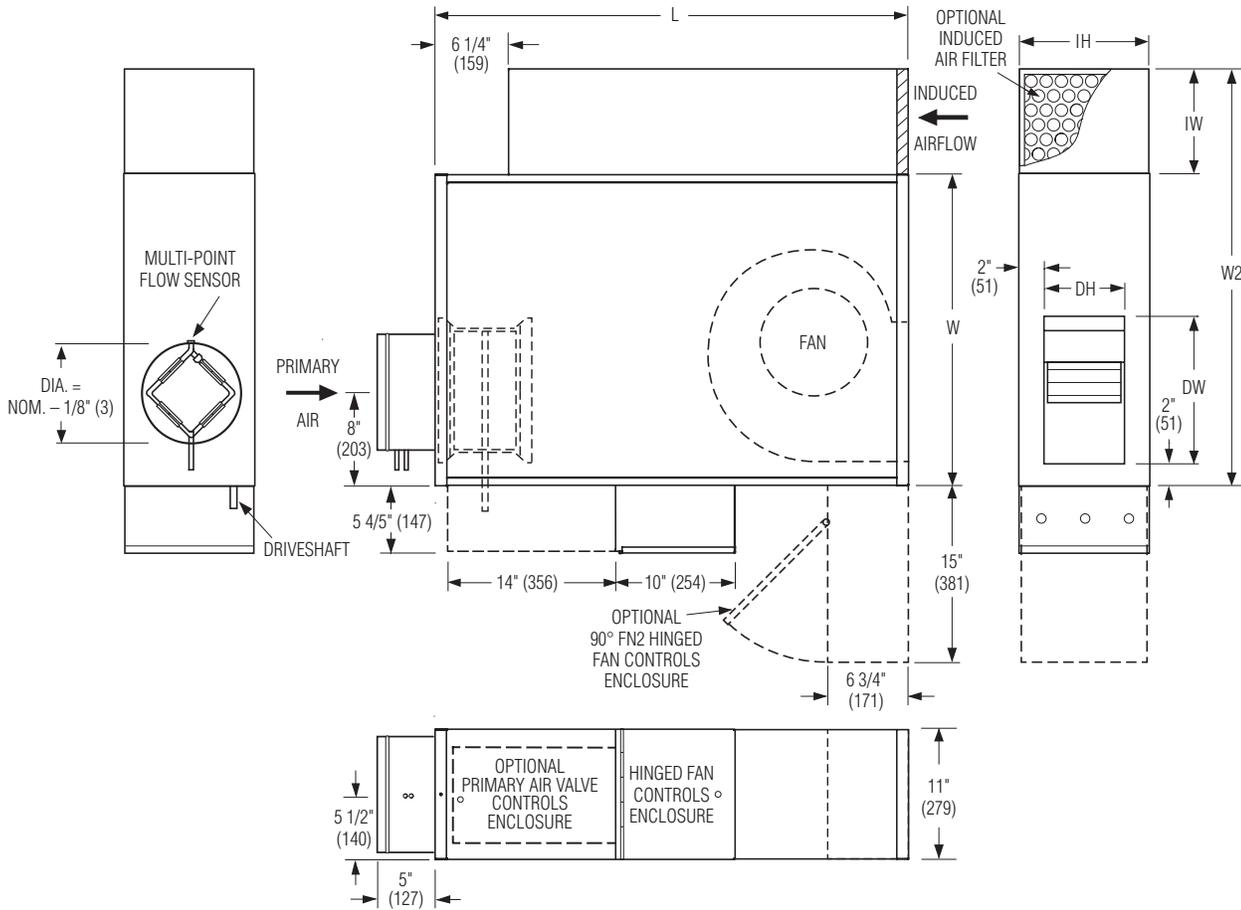

### Dimensional Data

Unit Size	Inlet Size	W	W2	L	Induced Air Inlet IW x IH	Outlet Discharge DW x DH	Filter Size
1	4, 5, 6, 8 (102, 127, 152, 203)	19 (483)	28 (711)	36 (914)	9 x 11 (229 x 279)	10 3/8 x 6 7/8 (264 x 175)	9 x 11 (229 x 279)
2	6, 8, 10 (152, 203, 254)	26 1/2 (673)	35 1/2 (902)	40 1/4 (1022)	12 x 11 (305 x 279)	11 3/8 x 6 7/8 (289 x 175)	12 x 11 (305 x 279)
3	6, 8, 10 (152, 203, 254)	26 1/2 (673)	35 1/2 (902)	40 1/4 (1022)	12 x 11 (305 x 279)	12 3/8 x 6 7/8 (314 x 175)	12 x 11 (305 x 279)

Dimensions

Model Series 37SST Stealth™ • Low Profile • Unit Size 4

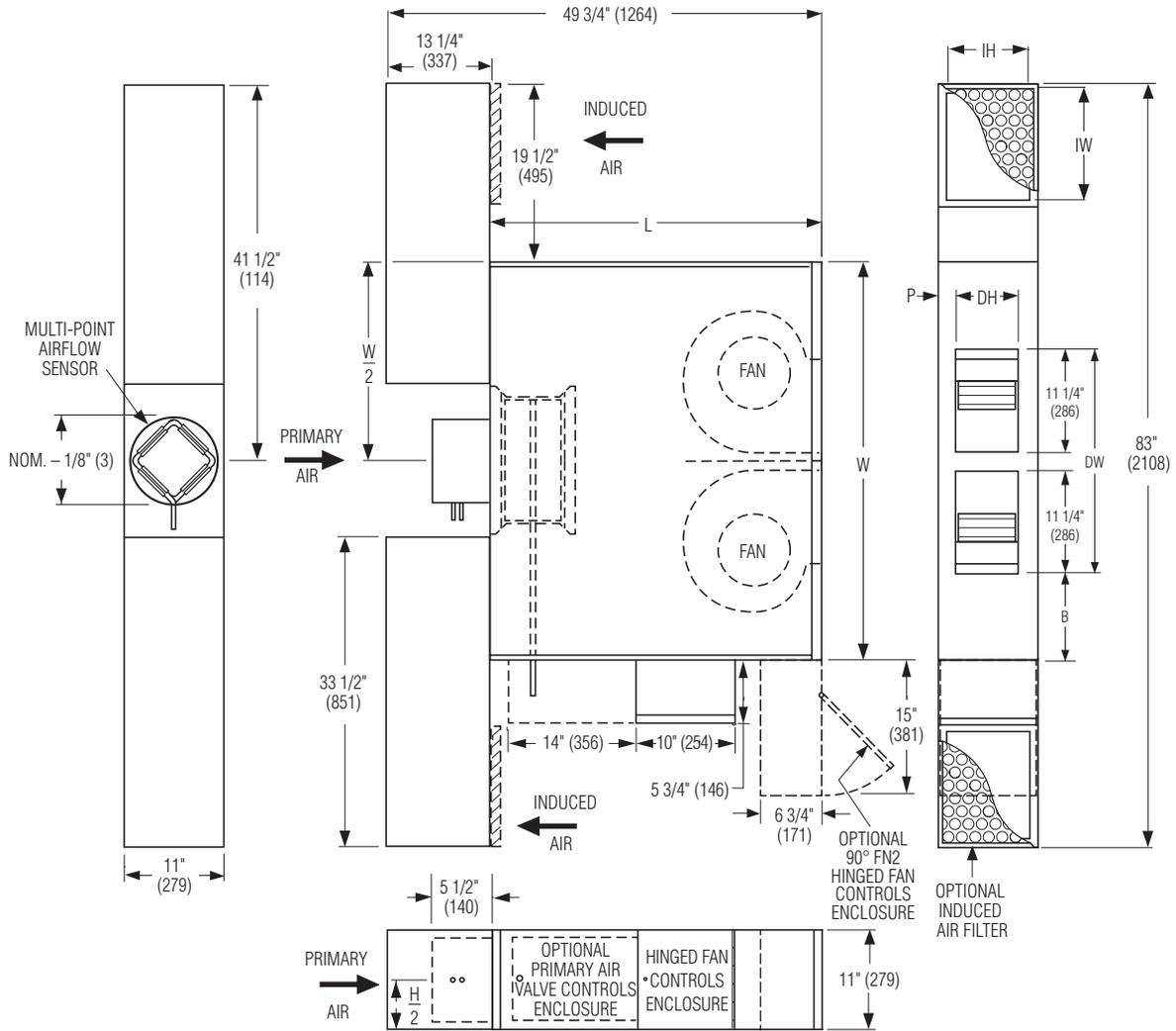

Dimensional Data

Unit Size	Inlet Size	W	L	B	P	Induced Air Inlet IW x IH	Outlet Discharge DW x DH	Filter Size
4	10 (254) Round 14 x 10 (356 x 254) Rect.	44 (1118)	36 1/2 (927)	9 3/4 (248)	2 1/16 (52)	12 x 9 (305 x 229) Qty. of 2	24 1/2 x 6 7/8 (622 x 175)	14 x 10 (356 x 254) Qty. of 2

## Dimensions

### Model Series 37SST Stealth™ • Low Profile • Series Flow

#### Hot Water Coil Section

#### Model 37SWST

Available in one, two or three row. Coil section installed on unit discharge. Right hand coil connection looking in direction of airflow standard (shown). Left hand is optional (terminals are inverted). Connections must be selected same hand as controls enclosure location.

#### Standard Features:

- Coil section installed on unit discharge.
- Coil (and header on multi-circuit units) is installed in insulated casing for increased thermal efficiency.
- 1/2" (13) copper tubes.
- Aluminum ripple fins.
- Sweat Connections:  
All size: 1 Row 1/2" (13), 2 and 3 Row 7/8" (22); O.D. male solder.
- Top and bottom access panels for inspection and coil cleaning.
- Flanged outlet duct connection.

#### Unit Sizes 1 — 3

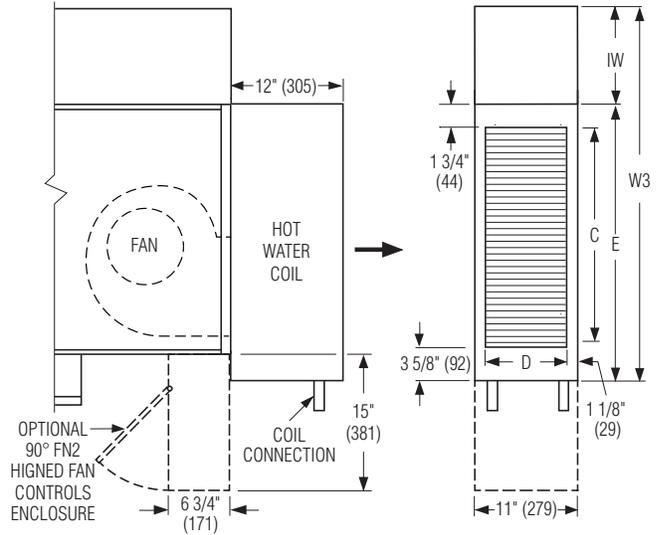

#### Unit Size 4

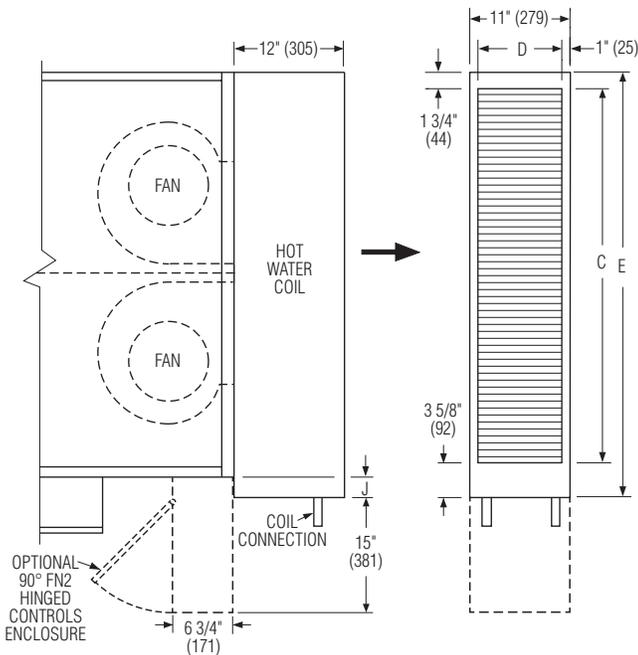

#### Unit Size 4 with FN2 Option

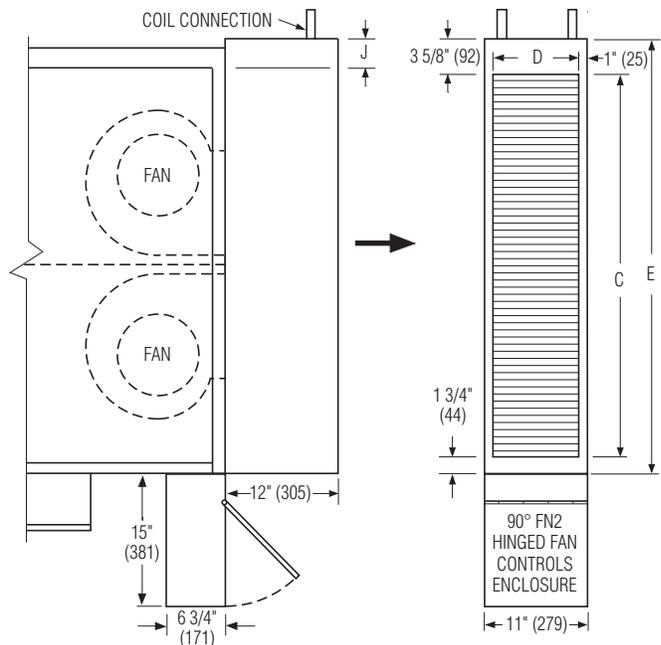

Unit Size	Outlet Duct Size C x D	IW	W3	E
1	14 5/8 x 8 3/4 (371 x 222)	9 (229)	29 (737)	20 (508)
2, 3	24 x 9 (610 x 229)	12 (305)	41 3/8 (1051)	29 3/8 (746)
4	41 x 9 (1041 x 229)	—	—	46 3/8 (1178)

## Dimensions

### Model Series 37SST Stealth™ • Low Profile • Series Flow

#### Electric Coil Section

#### Model 37SEST

##### Standard Features:

- Controls enclosure incorporates a hinged access door opening downstream that helps ensure NEC clearance requirements and reduces footprint.
- Coil installed on unit discharge.
- Insulated coil element wrapper.
- Automatic reset high limit cut-outs (one per element).
- Single point electrical connection for entire terminal unit.
- Positive pressure airflow switch.
- Magnetic contactors per stage.
- Class A 80/20 Ni/Cr wire.
- Flanged outlet duct connection.
- Terminal unit with coil is ETL Listed as an assembly.
- Controls mounted as standard on RH side as shown. Terminals ordered with LH controls (optional) are inverted.

##### Standard Supply Voltage (60 Hz):

- Single phase: 120, 208, 240 & 277V.
- Three phase: 208, 480 (4 wire wye) and 600V (dual point connection).

##### Options:

- Toggle disconnect switch (includes fan).
- Door interlock disconnect switch.
- Mercury contactors.
- Power circuit fusing.
- Dust tight construction.
- Manual reset secondary thermal cut out.
- SCR Control.

#### Unit Sizes 1 — 3

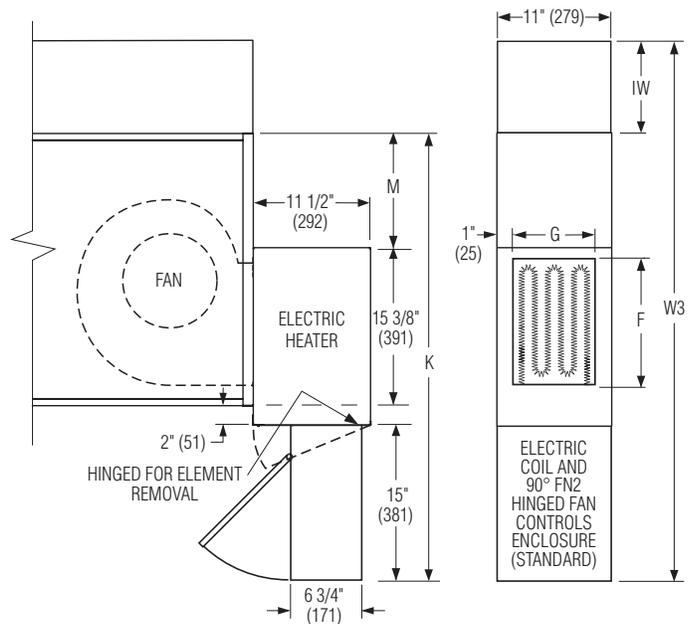

#### Unit Size 4

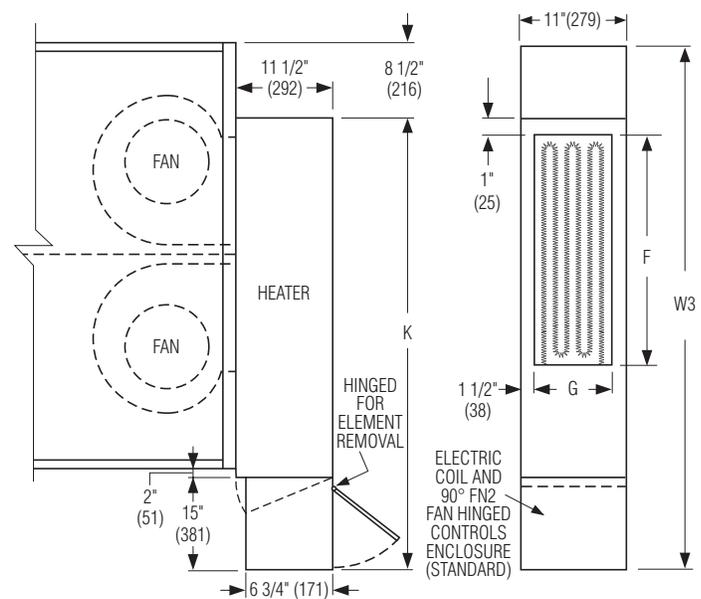

Unit Size	Outlet Duct Size F x G	IW	M	W3	K
1	12 3/8 x 9 (314 x 229)	9 (229)	3 5/8 (92)	44 7/8 (1140)	35 7/8 (911)
2			11 1/8 (283)	52 1/2 (1334)	43 1/2 (1105)
3			11 1/8 (283)	52 1/2 (1334)	43 1/2 (1105)
4	25 x 8 (635 x 203)	—	—	60 7/8 (1546)	52 3/8 (1330)

Performance Data

PSC Motor Fan Curves – Airflow vs. Downstream Static Pressure

37SST Stealth™ Series • Low Profile • Series Flow

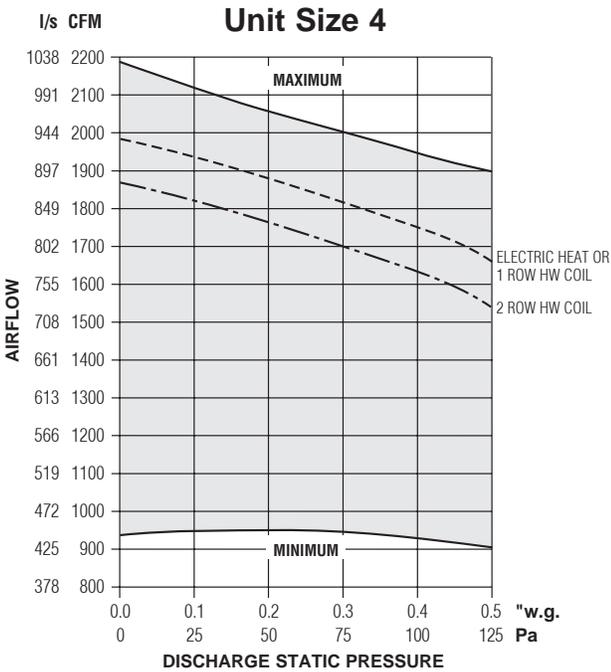
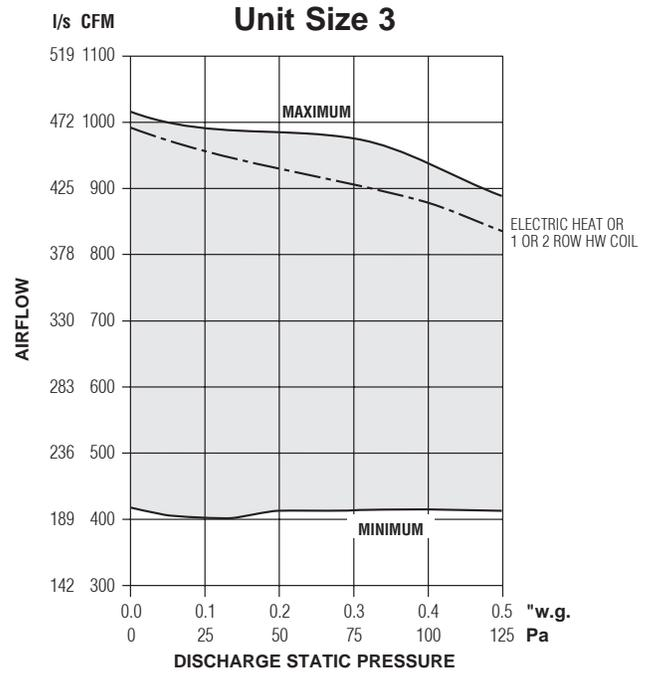
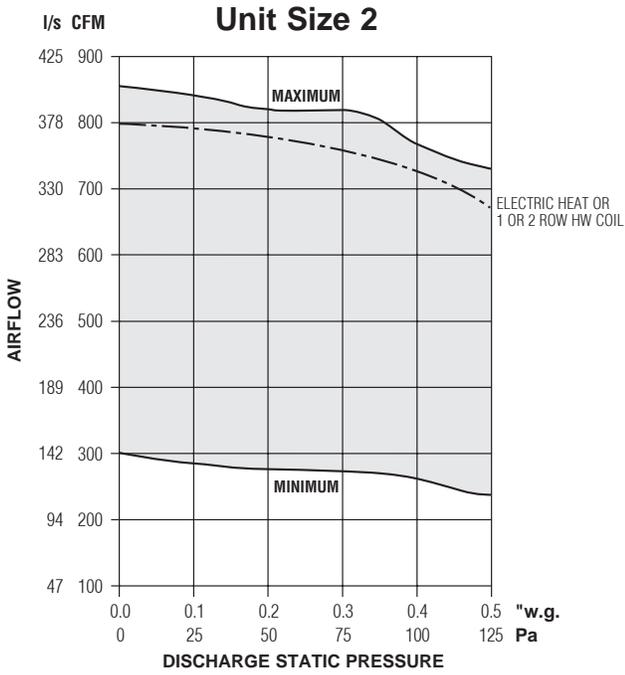

- Fan curves shown are applicable to 120, 208, 240 and 277 volt, single phase PSC motors.

Electrical Data

Unit Size	PSC Motor HP	PSC Motor FLA			
		120V	208V	240V	277V
2	1/6	4.8	1.8	1.8	1.5
3	1/4	5.3	3.6	3.6	1.8
4	2@1/4	10.6	7.2	7.2	3.7

FLA = Full load amperage.  
All motors are single phase/60 Hz.

## Performance Data

### ECM Motor Fan Curves – Airflow vs. Downstream Static Pressure 37SST Stealth™ Series • Low Profile • Series Flow

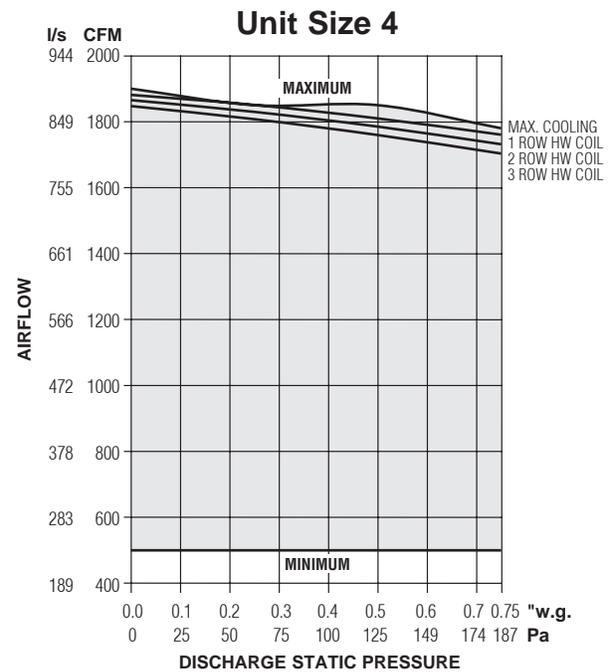
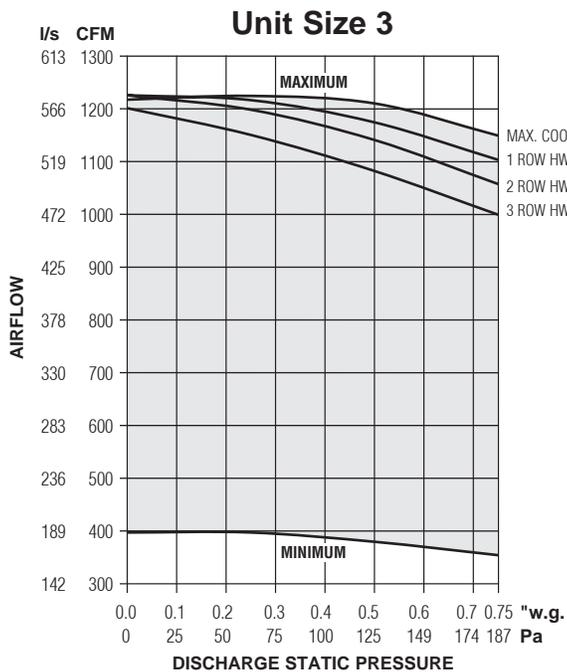
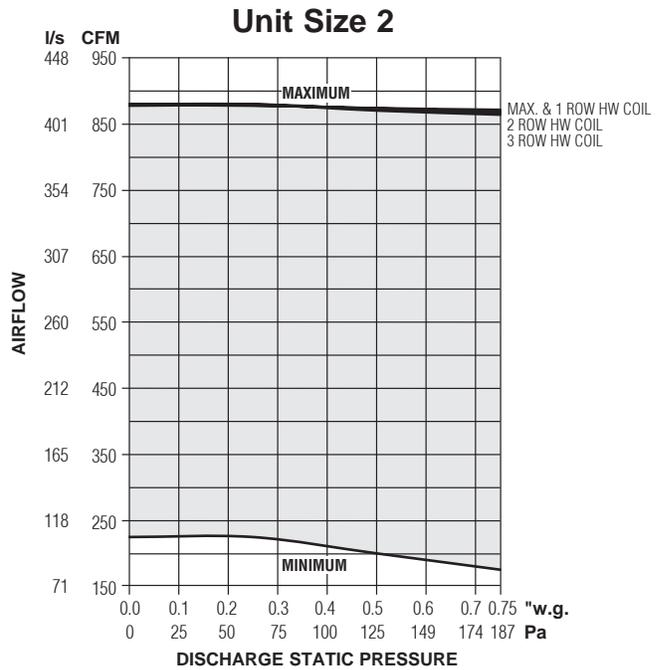
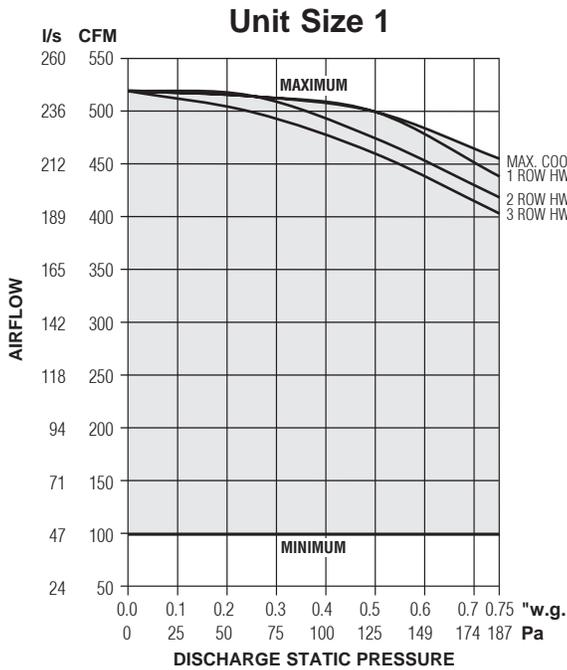

### Electrical Data

Unit Size	EPIC ECM Motor FLA				
	Motor HP	120V	208V	240V	277V
1	*	1.9	1.3	1.3	1.3
2	*	3.3	2.2	2.2	2.2
3	*	6.9	4.7	4.4	4.4
4	*	8.0	5.4	5.2	4.9

\* The EPIC ECM is a variable horsepower motor. Refer to Selectworks schedule for actual power consumption. FLA = Full load amperage. All motors are single phase/60 Hz.

### NOTES:

- The ECM is pressure independent and constant volume in operation at factory or field set point within the shaded area. Airflow does not vary with changing static pressure conditions. The motor compensates for any changes in external static pressure or induced air conditions such as filter loading.
- Airflow can be set to operate on horizontal performance line at any point within shaded area using the solid state volume controller provided.
- Fan curves shown are applicable to 120, 208, 240 and 277 volt, single phase ECM's. ECM's, although DC in operation, include a built-in inverter.

Performance Data • NC Level Application Guide

Model Series 37SST Stealth™ • Low Profile • Series Flow

Fiberglass Liner

Unit Size	Inlet Size	Airflow		Min. inlet ΔPs		NC Levels @ Inlet Pressure (ΔPs) shown												
						DISCHARGE					RADIATED							
						Fan Only	Min. ΔPs	0.5" w.g. (125 Pa)	1.0" w.g. (250 Pa)	1.5" w.g. (375 Pa)	2.0" w.g. (500 Pa)	Fan Only	Min. ΔPs	0.5" w.g. (125 Pa)	1.0" w.g. (250 Pa)	1.5" w.g. (375 Pa)	2.0" w.g. (500 Pa)	
1	6	400	189	0.15	37	26	24	25	25	25	25	28	25	25	28	29	30	
		300	142	0.07	17	21	-	20	21	21	21	-	20	21	23	25	26	
		200	94	0.02	5	24	20	21	21	24	24	-	-	-	-	-	-	
		100	47	0.01	1	-	-	-	-	21	20	-	-	-	-	-	-	
	8	400	189	0.02	4	26	23	24	25	24	24	28	25	25	28	29	30	
		300	142	0.01	2	21	-	-	20	20	21	-	20	21	23	25	26	
		200	94	0.01	2	24	-	-	20	21	21	-	-	-	-	-	-	
		100	47	0.01	2	-	-	-	-	-	-	-	-	-	-	-	-	
2	6	550	260	0.21	52	20	-	20	-	20	20	22	22	23	24	26	29	
		400	189	0.08	20	-	-	-	-	20	20	-	-	20	22	24	28	
		275	130	0.01	2	-	-	20	-	20	23	-	-	-	-	24	28	
	8	800	378	0.11	27	28	24	21	21	23	23	29	28	26	29	31	34	
		700	330	0.08	19	25	23	20	21	21	23	26	25	26	28	30	33	
		550	260	0.04	10	20	-	-	-	-	-	22	21	22	24	26	29	
		400	189	0.02	4	-	-	-	-	-	-	-	-	-	21	23	26	
		275	130	0.01	2	-	-	-	-	-	20	-	-	-	-	23	27	
	10	800	378	0.03	7	28	24	20	20	21	21	29	28	26	29	31	34	
		700	330	0.02	4	25	21	-	20	21	21	26	24	25	28	30	33	
		550	260	0.01	2	20	-	-	-	-	-	22	21	22	24	26	29	
		400	189	0.01	2	-	-	-	-	-	-	-	-	-	21	23	25	
		275	130	0.01	2	-	-	-	-	-	-	-	-	-	-	21	25	
	3	6	550	260	0.22	55	21	25	26	28	29	30	24	23	23	24	28	30
			400	189	0.09	22	-	-	-	-	20	21	-	-	-	-	23	25
		8	1100	519	0.15	37	34	35	34	35	35	35	32	34	34	35	35	35
900			425	0.09	22	30	31	31	31	31	33	30	31	31	31	33	33	
650			307	0.04	10	21	23	24	25	26	28	24	23	23	24	28	30	
400			189	0.01	2	-	-	-	-	-	-	-	-	-	-	21	24	
10		1150	543	0.05	12	35	35	34	35	35	35	33	34	34	34	35	36	
		1100	519	0.05	12	34	34	33	34	34	35	32	34	34	35	35	35	
		900	425	0.04	9	30	30	30	30	31	31	30	31	31	31	33	33	
		650	307	0.02	4	21	21	21	23	24	25	24	23	23	24	28	30	
4	10	1950	920	0.20	50	35	34	35	36	37	38	38	39	39	40	41	43	
		1800	849	0.17	42	33	31	33	34	36	37	35	38	38	39	40	41	
		1450	684	0.12	29	26	25	28	30	31	33	31	33	34	35	36	38	
		1100	519	0.08	19	-	-	21	24	26	26	25	28	26	29	31	34	
		800	378	0.05	11	-	-	-	-	-	20	20	-	21	25	28	30	
	14 x 10	1950	920	0.13	32	35	33	34	35	36	37	38	39	39	40	41	43	
		1800	849	0.12	30	33	30	33	33	35	36	35	38	38	39	40	41	
		1450	684	0.08	20	26	25	26	29	30	31	31	33	34	35	36	38	
		1100	519	0.05	11	-	-	-	21	25	25	25	28	26	29	31	34	
		800	378	0.03	7	-	-	-	-	-	-	20	-	21	24	28	30	

Performance Notes:

1. NC Levels are calculated based on procedures as outlined on page C160.
2. Dash (-) in space indicates a NC less than 20.

## Performance Data • Discharge Sound Power Levels

Model Series 37SST Stealth™ • Low Profile • Series Flow

Fiberglass Liner



Unit Size	Inlet Size	Airflow		Min. inlet ΔPs		Fan Only		Fan and 100% Primary Air – Sound Power Octave Bands @ Inlet pressure (ΔPs) shown																																		
								Minimum ΔPs							0.5" w.g. (125Pa) ΔPs							1.0" w.g. (249Pa) ΔPs							1.5" w.g. (375Pa) ΔPs							2.0" w.g. (500Pa) ΔPs						
								2	3	4	5	6	7	2	3	4	5	6	7	2	3	4	5	6	7	2	3	4	5	6	7	2	3	4	5	6	7					
1	6	400	189	0.15	37	72	67	62	58	54	50	70	64	59	51	47	41	71	64	58	51	47	42	71	66	59	52	49	44	71	65	57	46	39	31	70	66	58	46	40	32	
		300	142	0.07	17	68	62	57	52	47	41	66	58	53	45	39	33	67	59	53	45	39	33	67	63	55	46	41	36	68	62	54	40	31	22	68	63	56	42	33	24	
		200	94	0.02	5	67	60	54	49	43	36	64	52	45	37	30	22	65	54	45	36	29	20	65	58	48	33	24	-	67	62	56	42	34	28	67	63	57	44	35	28	
		100	47	0.01	1	63	56	50	44	37	29	60	47	38	30	23	-	61	49	39	29	-	-	62	54	43	25	-	-	65	61	55	39	31	24	64	61	56	41	32	24	
	8	400	189	0.02	4	72	67	62	58	54	50	69	63	58	51	47	41	70	64	58	51	47	42	70	66	58	52	49	44	70	65	56	46	39	31	70	65	58	46	40	32	
		300	142	0.01	2	68	62	57	52	47	41	65	57	52	44	39	33	66	58	52	45	39	33	66	62	54	46	41	36	67	62	53	40	31	22	67	63	55	42	33	24	
		200	94	0.01	2	67	60	54	49	43	36	62	51	44	37	30	22	63	53	44	36	29	20	64	57	47	33	24	-	65	61	55	42	34	28	65	61	56	43	35	28	
		100	47	0.01	2	63	56	50	44	37	29	58	45	37	29	22	-	59	48	38	29	-	-	60	52	42	24	-	-	63	60	54	39	30	24	62	59	55	41	32	24	
	2	6	550	260	0.21	52	63	62	59	56	53	48	65	60	58	54	49	43	67	58	57	52	47	41	65	60	58	53	47	41	67	61	58	53	47	41	67	62	58	53	47	41
			400	189	0.08	20	61	57	55	51	47	40	64	58	56	51	45	36	64	57	55	48	43	34	64	57	55	48	42	34	65	58	56	49	43	34	67	59	56	49	43	35
			275	130	0.01	2	59	52	50	46	40	30	62	58	51	46	40	29	64	53	49	43	36	24	63	55	51	43	36	25	64	56	52	44	37	26	66	56	53	45	38	28
		8	800	378	0.11	27	70	69	66	64	61	58	68	66	62	59	55	51	67	64	61	57	53	50	68	64	61	56	52	49	69	65	61	57	53	49	70	65	61	57	53	49
700			330	0.08	19	67	66	63	60	57	54	67	64	61	57	53	48	67	62	59	55	51	47	67	63	60	55	51	46	68	63	60	55	51	46	69	64	60	56	51	46	
550			260	0.04	10	63	62	59	56	53	48	64	60	58	54	49	43	65	58	56	52	47	41	64	60	57	52	47	41	65	60	57	52	47	41	66	61	58	52	47	41	
400			189	0.02	4	61	57	55	51	47	40	62	57	55	50	45	36	62	55	54	48	43	34	62	56	54	48	42	34	64	57	55	49	43	34	65	58	55	49	43	35	
10		275	130	0.01	2	59	52	50	46	40	30	60	56	50	45	39	28	62	52	49	43	36	24	61	53	50	43	36	25	62	54	51	44	37	26	64	55	52	44	37	28	
		800	378	0.03	7	70	69	66	64	61	58	68	66	61	59	55	51	66	63	60	57	53	50	67	63	61	56	52	49	68	64	60	57	53	49	69	64	61	57	53	49	
		700	330	0.02	4	67	66	63	60	57	54	66	63	60	57	53	48	66	61	59	55	51	47	66	62	59	55	51	46	67	63	59	55	51	46	68	63	59	55	51	46	
		550	260	0.01	2	63	62	59	56	53	48	63	59	57	53	49	43	64	57	56	51	47	41	63	59	57	52	47	41	64	60	57	51	47	41	65	61	57	52	47	41	
		400	189	0.01	2	61	57	55	51	47	40	60	56	54	50	45	36	61	54	53	48	43	34	60	55	53	48	42	34	62	56	54	48	43	34	63	57	54	48	43	35	
275	130	0.01	2	59	52	50	46	40	30	58	54	49	45	39	28	60	50	48	42	35	24	60	51	49	43	36	24	60	53	50	44	36	26	62	53	51	44	37	27			
3	6	550	260	0.22	55	68	63	60	59	55	51	71	65	61	58	53	49	72	66	61	58	53	49	73	66	61	58	53	49	74	67	62	58	54	49	75	68	62	59	54	49	
		400	189	0.09	22	63	58	56	53	49	44	62	59	56	51	47	41	64	59	56	52	47	41	65	61	56	52	47	41	67	62	57	52	47	41	68	63	57	52	47	41	
		1100	519	0.15	37	76	74	68	68	66	63	78	75	70	70	67	65	77	74	69	68	65	63	79	75	70	68	66	63	79	75	70	68	65	62							
	8	900	425	0.09	22	74	71	66	66	63	60	76	72	67	67	63	60	77	72	66	65	62	59	77	72	67	66	62	59	78	72	67	66	62	59	79	73	67	66	62	59	
		650	307	0.04	10	68	63	60	59	55	51	69	64	60	57	53	49	70	64	60	57	53	49	71	64	60	57	53	49	72	66	61	58	54	49	73	67	61	58	54	49	
		400	189	0.01	2	63	58	56	53	49	44	60	57	55	51	46	40	62	58	55	51	47	40	64	59	55	51	47	40	65	60	56	51	46	40	66	61	56	51	46	40	
	10	1150	543	0.05	12	77	75	69	68	66	64	77	75	70	70	68	65	77	74	69	68	66	63	78	75	69	68	66	63	79	75	69	68	66	63	80	75	69	68	66	63	
		1100	519	0.05	12	76	74	68	68	66	63	77	74	70	70	67	65	77	73	68	68	65	63	78	74	69	68	66	63	78	74	69	68	65	63	79	75	69	68	65	62	
		900	425	0.04	9	74	71	66	66	63	60	75	71	66	66	63	60	76	71	65	65	62	59	76	71	66	65	62	59	77	72	66	65	62	59	77	72	67	65	62	59	
		650	307	0.02	4	68	63	60	59	55	51	67	63	59	57	53	49	68	63	59	57	53	49	69	63	59	57	53	49	70	65	60	57	54	49	71	66	60	57	54	49	
		400	189	0.01	1	63	58	56	53	49	44	58	56	54	50	46	40	60	56	53	51	46	40	62	57	54	51	46	40	63	59	55	50	46	40	64	59	55	51	46	40	
	4	10	1950	920	0.20	50	79	75	74	74	72	69	77	74	72	72	70	67	78	75	73	73	71	68	79	76	74	74	71	69	81	77	76	75	72	70	81	78	76	75	72	70
1800			849	0.17	42	77	73	72	72	70	67	75	72	71	71	68	65	76	73	72	71	69	66	78	74	73	72	70	67	79	76	74	73	71	68	80	77	75	73	71	68	
1450			684	0.12	29	71	68	67	67	64	61	71	67	67	67	63	60	73	69	68	68	64	62	75	71	70	69	66	63	77	72	71	70	66	64	77	73	71	71	67	64	
1100			519	0.08	19	64	60	62	61	58	54	65	61	63	60	56	52	68	64	64	62	59	55	70	66	66	64	60	56	72	68	67	65	61	57	73	68	68	65	61	58	
800			378	0.05	11	59	57	59	58	54	48	59	56	59	56	52	45	63	58	60	58	54	48	64	60	61	58	55	49	66	62	62	59	56	50	67	63	63	60	56	51	
14 x 10		1950	920	0.13	32	79	75	74	74	72	69	76	73	72	72	70	67	77	74	73	73	71	68	78	75	74	74	71	69	80	76	75	75	72	70	80	77	75	75	72	70	
		1800	849	0.12	30	77	73	72	72	70	67	74	71	70	71	68	65	76	73	71	71	69	66	77	73	72	72	70	67													

## Performance Data • Radiated Sound Power Levels

Model Series 37SST Stealth™ • Low Profile • Series Flow

Fiberglass Liner



Unit Size	Inlet Size	Airflow		Min. inlet ΔPs		Fan Only		Fan and 100% Primary Air – Sound Power Octave Bands @ Inlet pressure (ΔPs) shown																																		
								Minimum ΔPs					0.5" w.g. (125Pa) ΔPs					1.0" w.g. (249Pa) ΔPs					1.5" w.g. (375Pa) ΔPs					2.0" w.g. (500Pa) ΔPs														
								2	3	4	5	6	7	2	3	4	5	6	7	2	3	4	5	6	7	2	3	4	5	6	7	2	3	4	5	6	7					
1	6	400	189	0.15	37	63	58	52	47	42	36	60	56	49	44	39	33	60	56	49	45	40	34	61	58	50	46	42	37	62	59	50	46	44	40	63	60	51	47	45	43	
		300	142	0.07	17	55	51	44	38	33	26	56	52	46	41	35	29	58	53	47	41	36	30	58	54	47	42	38	34	58	56	48	43	40	37	59	57	49	43	41	40	
		200	94	0.02	5	50	45	41	34	27	19	-	43	39	33	25	-	49	45	40	34	28	21	50	47	41	36	32	28	51	50	43	38	36	34	51	51	44	40	39	39	
		100	47	0.01	1	-	40	36	30	22	-	-	40	36	29	21	-	-	41	36	30	23	18	-	41	37	32	27	25	-	42	37	34	31	31	-	42	37	35	34	36	
	8	400	189	0.02	4	63	58	52	47	42	36	60	56	49	44	39	32	60	56	49	45	39	33	61	58	50	45	41	37	62	59	50	46	43	40	63	60	51	46	45	42	
		300	142	0.01	2	55	51	44	38	33	26	56	52	46	40	35	28	58	53	46	41	36	30	58	54	47	42	38	33	58	56	48	42	40	37	59	57	48	43	41	39	
		200	94	0.01	2	50	45	41	34	27	19	-	43	39	32	25	-	49	45	39	34	27	20	50	47	41	35	31	27	51	50	42	37	35	33	51	51	43	39	38	38	
		100	47	0.01	2	-	40	36	30	22	-	-	39	36	29	21	-	-	41	36	30	23	18	-	41	36	31	26	24	-	41	37	33	30	30	-	42	37	34	33	35	
	2	6	550	260	0.21	52	57	51	48	43	35	28	56	50	48	43	34	27	57	51	49	45	37	32	60	54	50	48	43	40	62	57	52	51	50	48	64	59	53	53	55	53
			400	189	0.08	20	53	48	45	40	32	26	51	47	45	40	30	22	55	48	46	44	38	32	57	51	48	48	45	41	59	54	50	52	52	50	60	56	51	55	57	56
			275	130	0.01	2	49	45	43	38	30	23	49	45	43	36	28	20	53	47	44	44	42	33	55	49	45	46	48	43	56	51	47	49	54	54	57	52	48	51	58	62
		8	800	378	0.11	27	65	58	54	51	42	36	64	56	52	48	41	35	63	56	52	48	42	37	65	59	54	51	46	42	66	61	55	54	51	47	67	63	56	55	53	51
700			330	0.08	19	62	55	52	48	39	33	61	54	51	46	38	33	61	54	52	47	40	36	63	57	53	50	45	41	65	60	55	53	49	47	66	62	56	54	53	51	
550			260	0.04	10	57	51	48	43	35	28	56	50	47	42	33	27	57	51	48	44	36	32	60	54	50	47	43	39	62	57	52	51	49	47	64	59	53	53	54	52	
400			189	0.02	4	53	48	45	40	32	26	51	47	44	39	30	22	55	48	45	43	38	31	57	51	47	47	44	40	59	54	49	51	51	48	60	56	51	54	56	55	
10		275	130	0.01	2	49	45	43	38	30	23	48	44	42	36	27	20	53	46	43	43	41	32	54	48	45	45	47	42	56	51	46	48	53	53	57	52	48	50	57	60	
		800	378	0.03	7	65	58	54	51	42	36	64	56	52	48	41	35	63	56	52	48	42	37	65	59	54	51	46	42	66	61	55	53	50	47	67	63	56	55	53	51	
		700	330	0.02	4	62	55	52	48	39	33	61	54	50	46	38	32	61	54	51	47	40	35	63	57	53	50	45	41	65	60	54	52	49	46	66	62	55	54	52	50	
		550	260	0.01	2	57	51	48	43	35	28	56	50	47	42	33	26	57	51	48	44	36	31	60	54	50	47	43	39	62	57	51	50	49	46	64	59	52	52	54	51	
		400	189	0.01	2	53	48	45	40	32	26	51	47	44	38	29	21	55	48	45	42	37	30	57	51	47	46	44	39	59	54	49	50	50	47	60	56	50	53	55	53	
275	130	0.01	2	49	45	43	38	30	23	48	44	42	35	26	19	52	46	43	42	40	31	54	48	45	45	46	41	55	50	46	47	51	51	56	51	47	49	55	58			
3	6	550	260	0.22	55	59	52	50	44	34	26	60	52	49	44	35	27	60	52	49	45	37	33	61	55	50	47	40	38	63	58	52	48	43	43	63	60	53	49	45	46	
		400	189	0.09	22	53	46	43	37	27	-	51	45	43	37	27	-	53	47	43	39	33	27	55	50	45	41	37	33	57	54	47	44	41	39	59	56	49	46	44	43	
		1100	519	0.15	37	67	61	57	57	48	39	68	63	56	52	45	38	69	63	56	52	45	39	70	63	57	54	46	42	70	64	58	55	47	46	70	64	58	55	48	48	
	8	900	425	0.09	22	64	58	55	53	41	34	67	58	53	49	41	35	67	58	53	49	42	37	67	60	54	50	43	40	68	61	55	51	44	43	68	62	56	52	45	46	
		650	307	0.04	10	59	52	50	44	34	26	60	52	48	43	34	27	60	52	48	44	36	32	61	55	50	46	39	37	63	58	51	47	42	41	63	60	52	48	44	45	
		400	189	0.01	2	53	46	43	37	27	-	51	45	42	36	26	-	53	47	43	38	32	26	55	50	45	40	36	32	57	53	47	43	40	38	58	55	48	45	43	42	
	10	1150	543	0.05	12	68	62	58	58	50	41	69	62	56	52	45	39	69	63	56	52	45	40	69	63	57	53	46	42	70	64	58	54	47	45	70	65	58	55	47	47	
		1100	519	0.05	12	67	61	57	57	48	39	68	63	56	52	44	37	69	63	56	52	45	39	70	63	57	53	46	42	70	64	58	54	47	45	70	64	58	55	48	47	
		900	425	0.04	9	64	58	55	53	41	34	67	58	52	49	41	35	67	58	53	49	41	36	67	60	54	50	42	39	68	61	55	50	43	43	68	62	55	51	44	45	
		650	307	0.02	4	59	52	50	44	34	26	60	52	48	43	33	26	60	52	48	43	35	31	61	55	49	45	38	35	63	58	51	46	41	40	63	60	52	47	43	44	
		400	189	0.01	1	53	46	43	37	27	-	50	44	42	35	25	-	52	46	43	37	31	25	54	49	44	40	35	31	56	53	46	42	39	37	58	55	48	44	41	41	
	4	10	1950	920	0.20	50	72	64	57	54	49	44	73	65	57	54	48	42	73	65	58	54	49	44	74	66	59	55	52	49	75	68	60	56	54	54	76	68	61	57	56	57
1800			849	0.17	42	70	62	56	52	47	42	72	63	56	52	46	40	72	63	57	53	48	43	73	65	58	54	51	48	74	67	59	56	53	53	75	68	60	57	55	57	
1450			684	0.12	29	67	58	53	49	43	36	68	59	53	48	41	35	69	60	54	49	44	40	70	62	56	51	48	46	71	64	58	53	52	52	72	65	60	55	55	56	
1100			519	0.08	19	62	54	49	44	37	29	64	54	49	44	36	29	63	55	50	46	43	39	65	58	53	49	47	46	67	61	56	52	52	52	69	63	57	54	55	57	
800			378	0.05	11	58	50	46	40	32	23	57	49	45	38	30	21	59	52	47	43	42	37	62	55	50	47	47	45	64	58	53	51	52	52	66	60	55	53	56	58	
14 x 10		1950	920	0.13	32	72	64	57	54	49	44	73	65	57	53	48	41	73	65	58	54	49	44	74	66	59	55	51	48	75	68	60	56	54	53	76	68	61	57	55	56	
		1800	849	0.12	30	70	62	56	52	47	42	72	63	56	52	45	39	72	63	57	52	47	43	73	65	58	54	50	48	74	67	59	55	53	53	75	68	60	56	55	56	
		1450	684	0.08	20	67	58	53	49	43	36	68	59	53	48	41	34	69	60	54	49	44																				

Performance Data • AHRI Certification and Performance Notes

Model Series 37SST Stealth™ • Low Profile • Series Flow • AHRI Certification Rating Points  
Fiberglass Liner

Unit Size	Inlet Size	Fan Airflow		Fan <sup>Σ</sup> Watts	Fan Only* @ .25" w.g. (62 Pa) ΔPs												Primary Airflow		Min. Inlet ΔPs	Fan + 100% Primary @ 1.5" w.g. (375 Pa) ΔPs w/ .25" w.g. (62 Pa) Discharge ΔPs						
					Discharge						Radiated									Radiated						
		cfm	l/s		2	3	4	5	6	7	2	3	4	5	6	7	cfm	l/s		"w.g.	Pa	2	3	4	5	6
1	8	400	189	140	72	67	62	58	54	50	63	58	52	47	42	36	400	189	0.02	4	62	59	50	46	43	40
2	10	800	378	170	70	69	66	64	61	58	65	58	54	51	42	36	800	378	0.03	7	66	61	55	53	50	47
3	10	1100	519	400	76	74	68	68	66	63	67	61	57	57	48	39	1100	519	0.05	12	70	64	58	54	47	45
4	14 x 10	1800	849	600	77	73	72	72	70	67	70	62	56	52	47	42	1800	849	0.12	30	74	67	59	55	53	53

<sup>Σ</sup> Motor = ECM.

\* Primary air valve is closed and therefore primary cfm is zero.



Ratings are certified in accordance with AHRI Standards.

Performance Notes for Sound Power Levels:

- Discharge (external) static pressure is 0.25" w.g. (63 Pa) in all cases, which is the difference (ΔPs) in static pressure from terminal discharge to the room.  
Discharge Sound Power Levels (SWL) now include duct end reflection energy as part of the standard rating. Including the duct end correction provides sound power levels that would normally be transmitted into an acoustically, non-reflective duct. The effect of including the energy correction to the discharge SWL, is higher sound power levels when compared to previous AHRI certified data. For more information on duct end reflection calculations see AHRI Standard 880.
- Radiated sound power is the breakout noise transmitted through the unit casing walls.
- Sound power levels are in decibels, dB re 10<sup>-12</sup> watts.
- All sound data listed by octave bands is raw data without any corrections for room absorption or duct attenuation. Dash (-) in space indicates sound power level is less than 20 dB or equal to background.
- Min. inlet ΔPs is the minimum operating pressure of the primary air valve section.
- Asterisk (\*) in space indicates that the minimum inlet static pressure requirement is greater than 0.5" w.g. (125 Pa) at rated airflow.
- Data derived from independent tests conducted in accordance with ANSI / ASHRAE Standard 130 and AHRI Standard 880.

## Performance Data • Hot Water Coil

Models: 37SW and 37SWST • Low Profile • Series Flow

### Unit Size 1

#### 1 Row (single circuit)

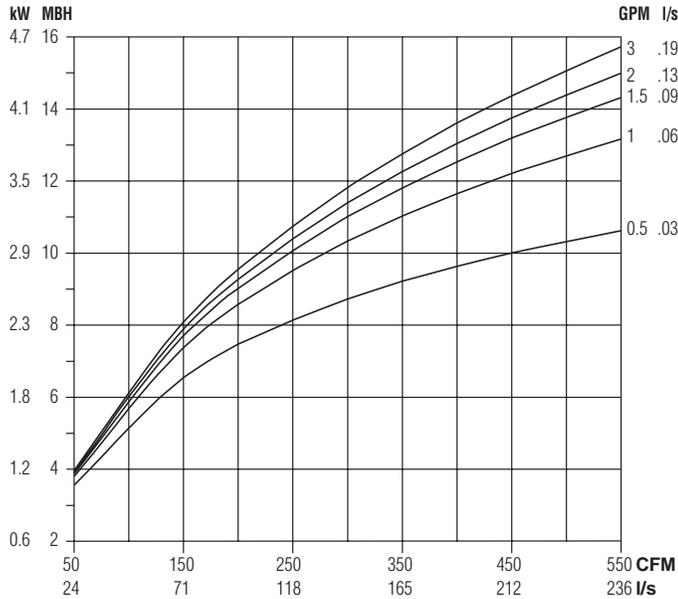

#### 2 Row (multi-circuit)

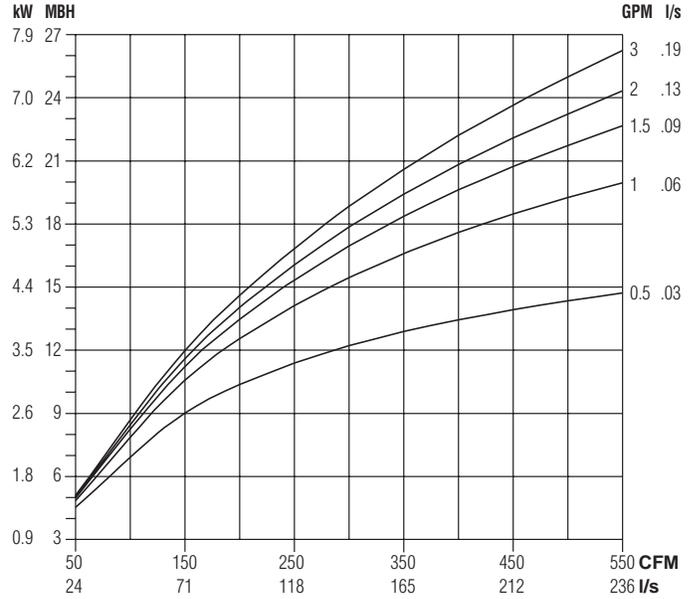

#### 3 Row (multi-circuit)

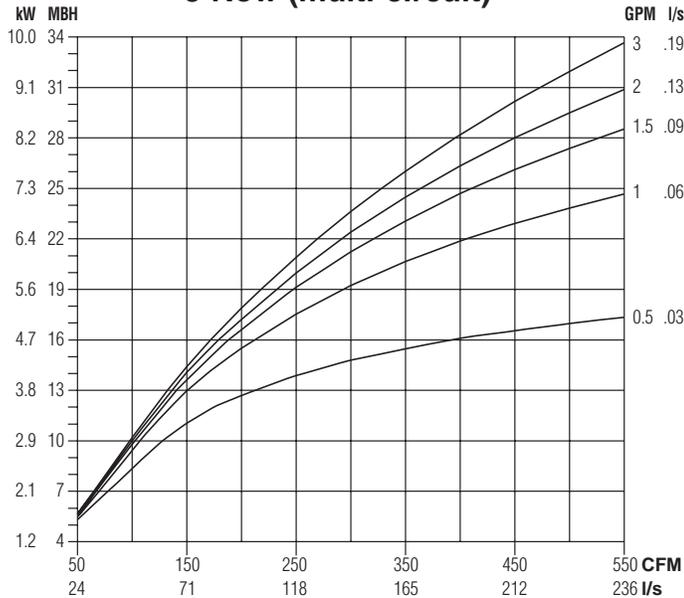

#### Water Pressure Drop

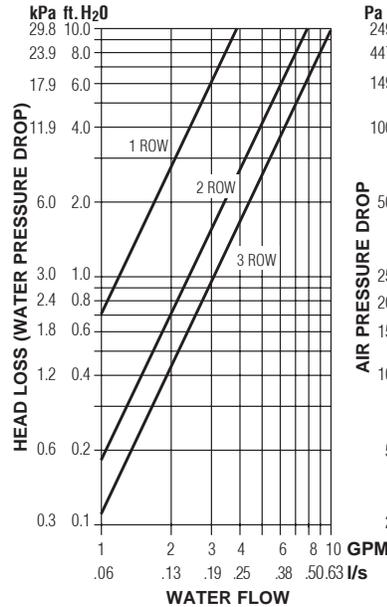

#### Air Pressure Drop

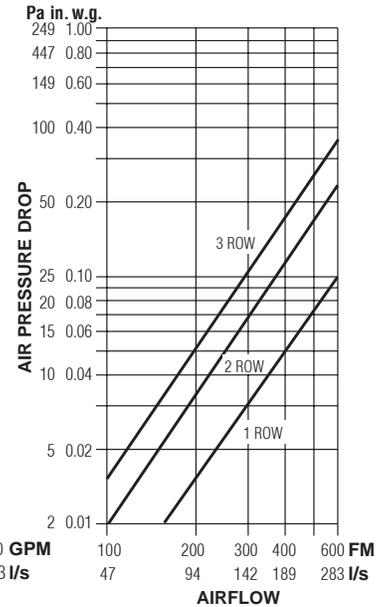

### NOTES:

- Capacities are in MBH (kW), **thousands of Btu per hour (kiloWatts)**.
- MBH (kW) values are based on a  $\Delta t$  (temperature difference) of 110°F (61°C) between entering air and entering water. For other  $\Delta t$ 's; multiply the MBH (kW) values by the factors below.

- Air Temperature Rise.

$$\text{ATR (}^\circ\text{F)} = 927 \times \frac{\text{MBH}}{\text{cfm}}, \text{ ATR (}^\circ\text{C)} = 829 \times \frac{\text{kW}}{\text{l/s}}$$

- Water Temp. Drop.

$$\text{WTD (}^\circ\text{F)} = 2.04 \times \frac{\text{MBH}}{\text{GPM}}, \text{ WTD (}^\circ\text{C)} = .224 \times \frac{\text{kW}}{\text{l/s}}$$

- Connections: 1 Row 1/2" (13), 2 and 3 Row 7/8" (22); O.D. male solder.

### Altitude Correction Factors:

Altitude ft. (m)	Sensible Heat Factor
0 (0)	1.00
2000 (610)	0.94
3000 (914)	0.90
4000 (1219)	0.87
5000 (1524)	0.84
6000 (1829)	0.81
7000 (2134)	0.78

### Correction factors at other entering conditions:

$\Delta t$ °F (°C)	50 (28)	60 (33)	70 (39)	80 (44)	90 (50)	100 (56)	110 (61)	120 (67)	130 (72)	140 (78)	150 (83)
Factor	.455 (.459)	.545 (.541)	.636 (.639)	.727 (.721)	.818 (.820)	.909 (.918)	1.00 (1.00)	1.09 (1.10)	1.18 (1.18)	1.27 (1.28)	1.36 (1.36)

## Performance Data • Hot Water Coil

Models: 37SW and 37SWST • Low Profile • Series Flow

### Unit Sizes 2 & 3

#### 1 Row (single circuit)

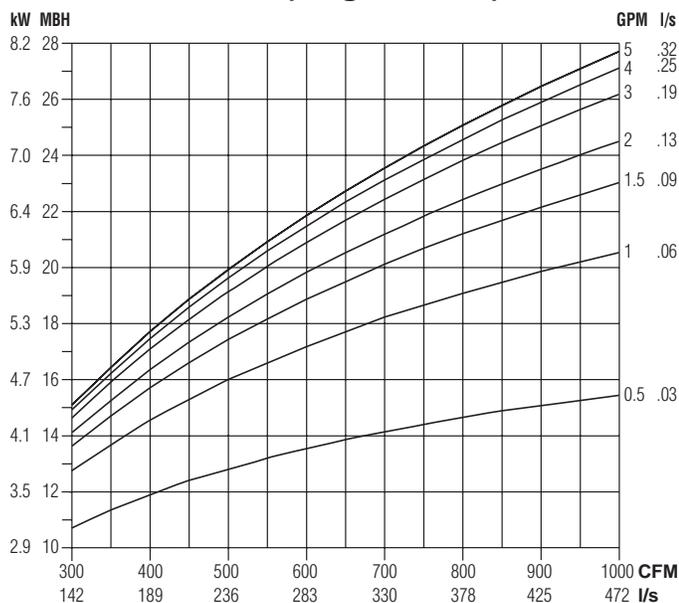

#### 2 Row (multi-circuit)

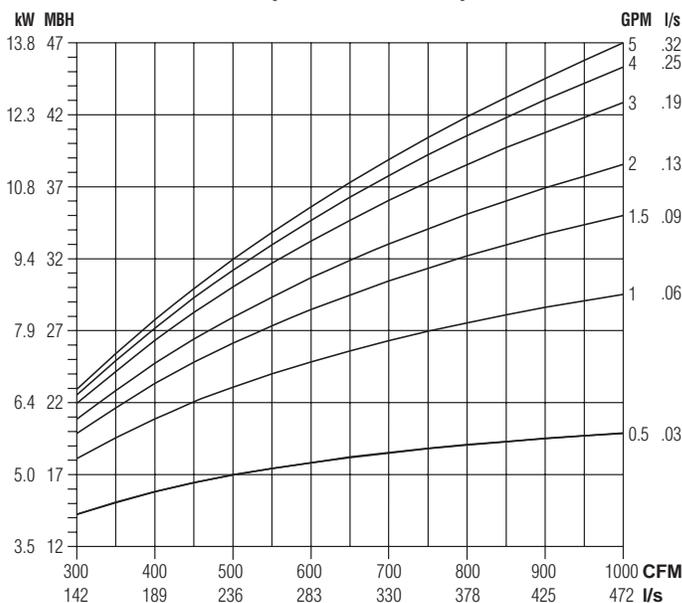

#### 3 Row (multi-circuit)

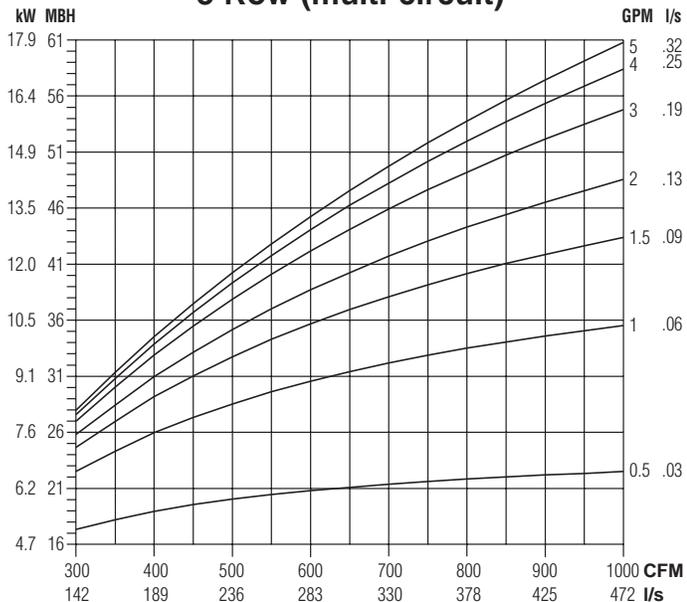

#### Water Pressure Drop

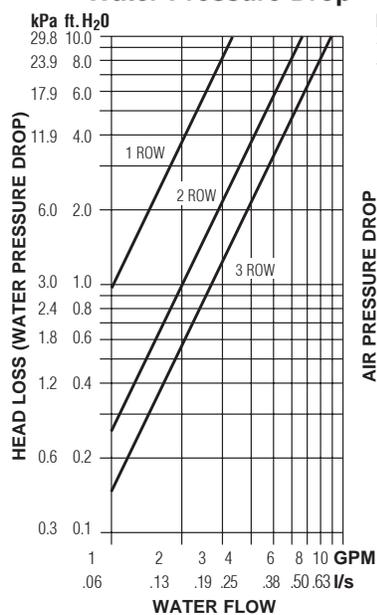

#### Air Pressure Drop

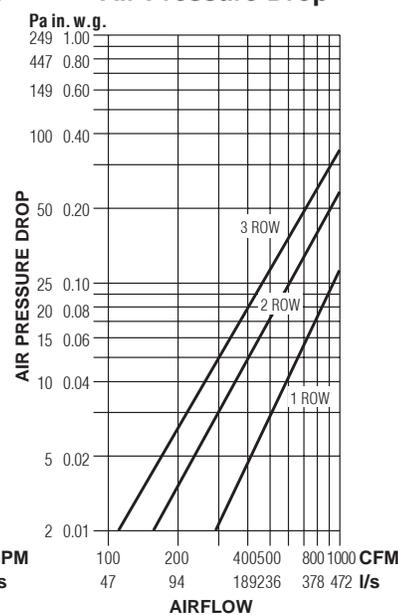

#### NOTES:

- Capacities are in MBH (kW), **thousands of Btu per hour (kiloWatts)**.
- MBH (kW) values are based on a  $\Delta t$  (temperature difference) of 110°F (61°C) between entering air and entering water. For other  $\Delta t$ 's; multiply the MBH (kW) values by the factors below.

- Air Temperature Rise.  
 $ATR (^\circ F) = 927 \times \frac{MBH}{cfm}$ ,  $ATR (^\circ C) = 829 \times \frac{kW}{I/s}$
- Water Temp. Drop.  
 $WTD (^\circ F) = 2.04 \times \frac{MBH}{GPM}$ ,  $WTD (^\circ C) = .224 \times \frac{kW}{I/s}$
- Connections: 1 Row 1/2" (13), 2 and 3 Row 7/8" (22); O.D. male solder.

#### Altitude Correction Factors:

Altitude ft. (m)	Sensible Heat Factor
0 (0)	1.00
2000 (610)	0.94
3000 (914)	0.90
4000 (1219)	0.87
5000 (1524)	0.84
6000 (1829)	0.81
7000 (2134)	0.78

#### Correction factors at other entering conditions:

$\Delta t$ °F (°C)	50 (28)	60 (33)	70 (39)	80 (44)	90 (50)	100 (56)	110 (61)	120 (67)	130 (72)	140 (78)	150 (83)
Factor	.455 (.459)	.545 (.541)	.636 (.639)	.727 (.721)	.818 (.820)	.909 (.918)	1.00 (1.00)	1.09 (1.10)	1.18 (1.18)	1.27 (1.28)	1.36 (1.36)

## Performance Data • Hot Water Coil

Models: 37SW and 37SWST • Low Profile • Series Flow

### Unit Size 4

#### 1 Row (single circuit)

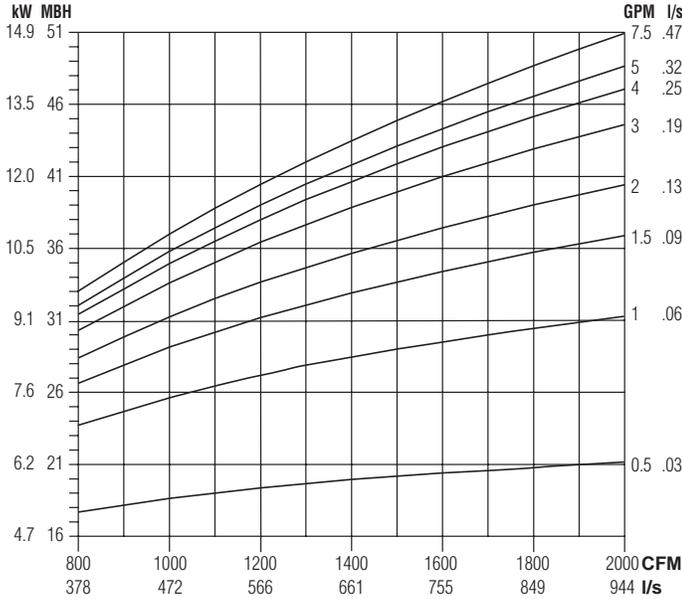

#### 2 Row (multi-circuit)

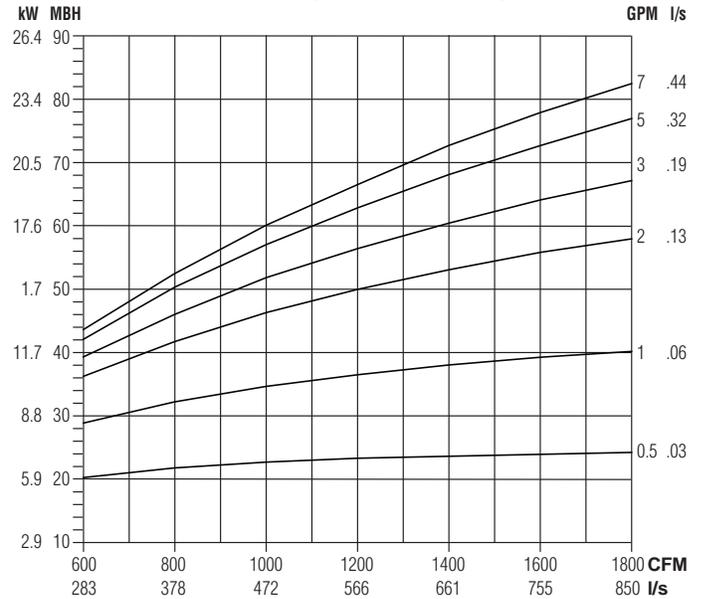

#### 3 Row (multi-circuit)

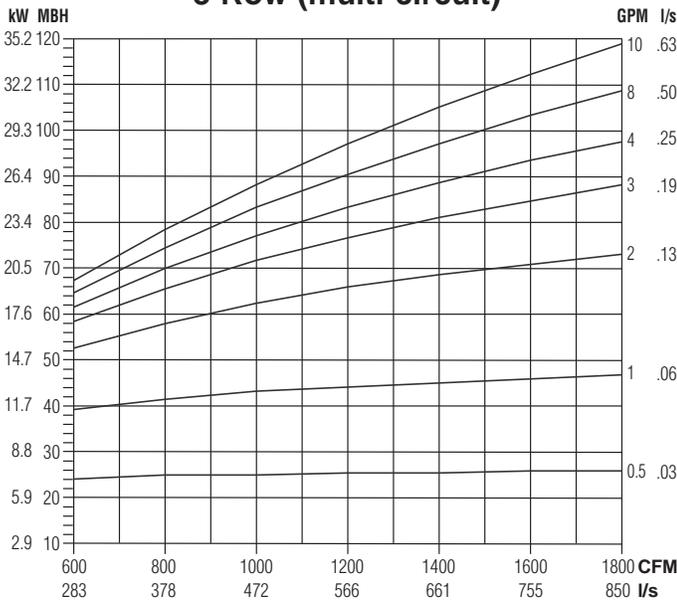

#### Water Pressure Drop

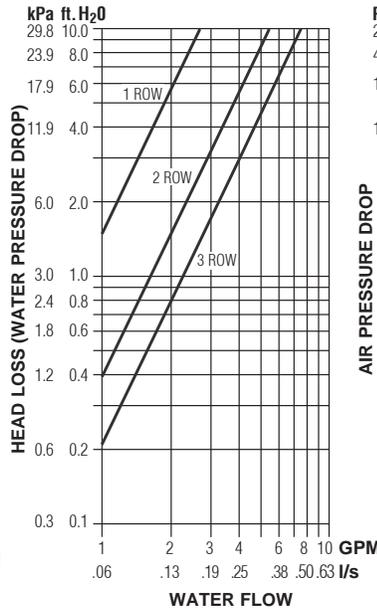

#### Air Pressure Drop

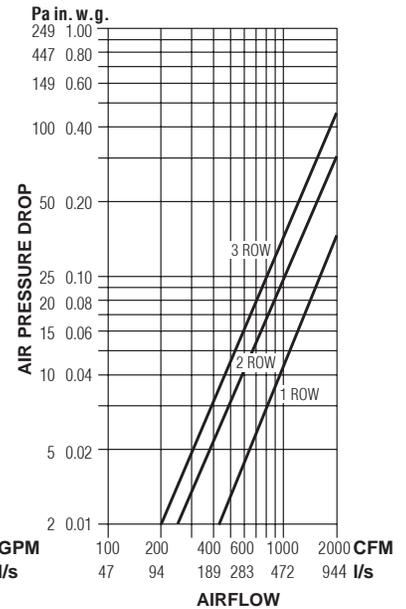

#### NOTES:

- Capacities are in MBH (kW), *thousands of Btu per hour (kiloWatts)*.
- MBH (kW) values are based on a  $\Delta t$  (temperature difference) of 110°F (61°C) between entering air and entering water. For other  $\Delta t$ 's; multiply the MBH (kW) values by the factors below.

- Air Temperature Rise.  
 $ATR (^{\circ}F) = 927 \times \frac{MBH}{cfm}$ ,  $ATR (^{\circ}C) = 829 \times \frac{kW}{l/s}$
- Water Temp. Drop.  
 $WTD (^{\circ}F) = 2.04 \times \frac{MBH}{GPM}$ ,  $WTD (^{\circ}C) = .224 \times \frac{kW}{l/s}$
- Connections: 1 Row 1/2" (13), 2 and 3 Row 7/8" (22); O.D. male solder.

#### Altitude Correction Factors:

Altitude ft. (m)	Sensible Heat Factor
0 (0)	1.00
2000 (610)	0.94
3000 (914)	0.90
4000 (1219)	0.87
5000 (1524)	0.84
6000 (1829)	0.81
7000 (2134)	0.78

#### Correction factors at other entering conditions:

$\Delta t$ °F (°C)	50 (28)	60 (33)	70 (39)	80 (44)	90 (50)	100 (56)	110 (61)	120 (67)	130 (72)	140 (78)	150 (83)
Factor	.455 (.459)	.545 (.541)	.636 (.639)	.727 (.721)	.818 (.820)	.909 (.918)	1.00 (1.00)	1.09 (1.10)	1.18 (1.18)	1.27 (1.28)	1.36 (1.36)

## Performance Data Explanation

### Sound Power Levels vs. NC Levels

The **Nailor Model Series: 35S, 35SST, 37S, 37SST, 35N and 37N** fan powered terminal unit performance data is presented in two forms.

The laboratory obtained discharge and radiated sound power levels in octave bands 2 through 7 (125 through 4000 Hz) center frequency for each unit size at various flow rates and inlet static pressures is presented. This data is derived in accordance with ANSI/ASHRAE Standard 130 and AHRI Standard 880. This data is raw with no attenuation deductions and includes AHRI Certification standard rating points.

Nailor also provides an "NC Level" table as an application aid in terminal selection, which include attenuation allowances as explained below. The suggested attenuation allowances are typical and are not representative of specific job site conditions. It is recommended that the sound power level data be used and a detailed NC calculation be performed using the procedures outlined in AHRI Standard 885, Appendix E for accurate space sound levels.

### Explanation of NC Levels

Tabulated NC levels are based on attenuation values as outlined in AHRI Standard 885 Procedure for Estimating Occupied Space Sound Levels in the Application of Air Terminals and Air Outlets". AHRI Standard 885, Appendix E provides typical sound attenuation values for air terminal discharge sound and air terminal radiated sound.

As stated in AHRI Standard 885, Appendix E, These values can be used as a quick method of estimating space sound levels when a detailed evaluation is not available. The attenuation values are required for use by manufacturers to catalog application sound levels. In product catalogs, the end user environments are not known and the following factors are provided as typical attenuation values. Use of these values will allow better comparison between manufacturers and give the end user a value which will be expected to be applicable for many types of space.

### Radiated Sound

Table E1 of Appendix E provides typical radiated sound attenuation values for three types of ceiling: Type 1 – Glass Fiber; Type 2 – Mineral Fiber; Type 3 – Solid Gypsum Board.

Since Mineral Fiber tile ceilings are the most common construction used in commercial buildings, these values have been used to tabulate Radiated NC levels.

The following table provides the calculation method for the radiated sound total attenuation values based on AHRI Standard 885.

	Octave Band					
	2	3	4	5	6	7
Environmental Effect	2	1	0	0	0	0
Ceiling/Space Effect	16	18	20	26	31	36
<b>Total Attenuation Deduction</b>	<b>18</b>	<b>19</b>	<b>20</b>	<b>26</b>	<b>31</b>	<b>36</b>

The ceiling/space effect assumes the following conditions:

1. 5/8" (16) tile, 20 lb/ft<sup>3</sup> (320 kg/m<sup>3</sup>) density.
2. The plenum is at least 3 feet (914) deep.
3. The plenum space is either wide [over 30 feet (9 m)] or lined with insulation.
4. The ceiling has no significant penetration directly under the unit.

### Discharge Sound

Table E1 of Appendix E provides typical discharge sound attenuation values for three sizes of terminal unit.

1. Small box; Less than 300 cfm (142 l/s)  
[Discharge Duct 8" x 8" (203 x 203)].
2. Medium box; 300 – 700 cfm (142 - 330 l/s)  
[Discharge Duct 12" x 12" (305 x 305)].
3. Large box; Greater than 700 cfm (330 l/s)  
[Discharge Duct 15" x 15" (381 x 381)].

These attenuation values have been used to tabulate Discharge NC levels applied against the terminal airflow volume and not terminal unit size.

The following tables provide the calculation method for the discharge sound total attenuation values based on AHRI Standard 885.

Small Box <300 cfm	Octave Band					
	2	3	4	5	6	7
Environmental Effect	2	1	0	0	0	0
5 ft. (1.5 m) 1" (25) Duct Lining	2	6	12	25	29	18
Branch Power Division (1 outlet)	0	0	0	0	0	0
5 ft. (1.5 m), 8 in. dia. (203) Flex Duct	5	10	18	19	21	12
End Reflection	10	5	2	1	0	0
Space Effect	5	6	7	8	9	10
<b>Total Attenuation Deduction</b>	<b>24</b>	<b>28</b>	<b>39</b>	<b>53</b>	<b>59</b>	<b>40</b>

Medium Box 300 – 700 cfm	Octave Band					
	2	3	4	5	6	7
Environmental Effect	2	1	0	0	0	0
5 ft. (1.5 m) 1" (25) Duct Lining	2	4	10	20	20	14
Branch Power Division (2 outlets)	3	3	3	3	3	3
5 ft. (1.5 m), 8 in. dia. (203) Flex Duct	5	10	18	19	21	12
End Reflection	10	5	2	1	0	0
Space Effect	5	6	7	8	9	10
<b>Total Attenuation Deduction</b>	<b>27</b>	<b>29</b>	<b>40</b>	<b>51</b>	<b>53</b>	<b>39</b>

Large Box >700 cfm	Octave Band					
	2	3	4	5	6	7
Environmental Effect	2	1	0	0	0	0
5 ft. (1.5 m) 1" (25) Duct Lining	2	3	9	18	17	12
Branch Power Division (3 outlets)	5	5	5	5	5	5
5 ft. (1.5 m), 8 in. dia. (203) Flex Duct	5	10	18	19	21	12
End Reflection	10	5	2	1	0	0
Space Effect	5	6	7	8	9	10
<b>Total Attenuation Deduction</b>	<b>29</b>	<b>30</b>	<b>41</b>	<b>51</b>	<b>52</b>	<b>39</b>

1. Flexible duct is non-metallic with 1" (25) insulation.
2. Space effect (room size and receiver location) 2500 ft.<sup>3</sup> (69 m<sup>3</sup>) and 5 ft. (1.5 m) distance from source.

For a complete explanation of the attenuation factors and the procedures for calculating room NC levels, please refer to the acoustical engineering guidelines at the back of this catalog and AHRI Standard 885.

## Electric Heating Coils

### Features, Selection and Capacities

**Nailor Electric Coils** are tested with terminal units in accordance with UL Standard 1995 and meet all requirements of the NEC (National Electric Code) and CSA (Canadian Standards Association). Units are listed and labeled by the ETL Testing Laboratory as a total package. All controls are enclosed in a NEMA 1 electrical enclosure on the side of the fan package for easy access.

All wiring for the motor and heater terminates in the enclosure for single point electrical connection in the field. Each unit is supplied with a wiring diagram. Note: NEC requires a means to disconnect the heater power supply within sight or on the terminal.

#### Standard Features:

- Automatic reset high limit thermal cut-outs.
- Magnetic contactors per stage on terminals with DDC or analog electronic controls.
- P.E. switch per stage to carry load or pilot duty with magnetic contactors as required with pneumatic control.
- Positive pressure airflow safety switch.
- P.E. switch for fan on parallel terminals (P35NE) with pneumatic control.
- Fan relay for DDC fan terminals.
- Control voltage transformer (Class II) for DDC or analog electronic terminals.
- Class A 80/20 Ni/Cr wire.

#### Options:

- Toggle disconnect switch.
- Door interlocking disconnect switch.
- Mercury contactors.
- Power circuit fusing.
- Dust tight control enclosure.
- Manual reset high limits.
- SCR Control.

#### SCR Control Option:

The SCR (Silicon Controlled Rectifier) option provides infinite solid state heater control using a proportional signal (0 – 10 Vdc or 4 – 20 mA). This option may be specified compatible with pneumatic, analog electronic or digital (DDC) controls.

Time proportional control of the electric heater provides superior comfort and energy savings. The SCR controller modulates the heater to supply the exact amount of heat based upon the zone requirement. Room set points are maintained more accurately, undershoot and overshoot as associated with staged heat are eliminated, reducing operation costs.

SCR controllers provide silent operation, as mechanical staged contactors are eliminated. Zero cross switching of the thyristor prevents electrical noise.



Models	Unit Size	Maximum KiloWatts - 1 Stage Heat				
		120 Volt 1 phase	208/240 Volt 1 phase	277 Volt 1 phase	208 Volt 3 phase	480 & 600 Volt 3 phase
<b>33SZE</b>	30	4.5	10*	11.5	14.5	15
	40	4.5	10*	11.5	14.5	18
	50	4.5	10*	11.5	14.5	25
<b>35SE 35SEST</b>	1	–	8	8	10	8
	2	–	8	8	10	8
	3	–	8	11.5	10	14
	4	–	8	11.5	10	16
	5	–	8	11.5	14.5	20.5
	6	–	8	11.5	14.5	26
	7	–	8	11.5	14.5	30
<b>37SE 37SEST</b>	1	–	5.5	5.5	5.5	5.5
	2	–	10.5**	12	12	12
	3	–	10***	12	15.5	17
	4	–	8	11.5	14.5	27
<b>35NE</b>	2	–	8	8	10	8
	3	–	8	11.5	10	14
	5	–	8	11.5	14.5	20.5
	6	–	8	11.5	14.5	26
<b>37NE</b>	2	–	8	11.5	11.5	11.5
	3	–	8	11.5	13.5	16
	4	–	8	11.5	14.5	27

\*208V max is 8.5  
 \*\*208V max is 9.0  
 \*\*\*208V max is 8.5

#### Recommended Selection:

The table above is a quick reference guide, to illustrate the relationship between electrical power supply, heater capacity in kiloWatts and terminal unit size that are available for fan powered units.

- Digital and pneumatic control terminals are available with up to 3 stages of heat. Analog electronic control terminals are available with 1 or 2 stages of heat only. A minimum of 0.5 kW per stage is required.

- Voltage and kilowatt ratings are sized so as not to exceed 48 amps, in order to avoid the NEC code requirement for circuit fusing.

- A minimum airflow of 70 cfm (33 l/s) per kW is required for any given terminal in order to avoid possible nuisance tripping of the thermal cutouts.

- Discharge air temperature should not exceed 120°F (49°C).



Tested and approved to the following standards:  
**ANSI/UL 1995, 1<sup>st</sup> ed.**  
**CSA C22.2 No. 236.**

## Electric Heating Coils (continued)

### Application Guidelines

#### Discharge Air Temperature

When considering the capacity and airflow for the heater, discharge air temperature can be an important factor. Rooms use different types of diffusers and they are intended to perform different functions. Slots that blend the air at the glass and set up air curtains within the room, must be able to blow the air very low in the room. Hot air will be too buoyant to be effective in this case. Discharge air temperatures for this application should be in the 85 – 90°F (29 – 32°C) range.

Diffusers in the center of the room blend their discharge air as it crosses the ceiling. Discharge air temperatures in this application can be as high as 105°F (41°C) and still be effective. However, if the return air grilles are in the discharge air pattern, the warm air will be returned to the plenum before it heats the room. Again, the air temperature needs to be blended down to an acceptable temperature that can be forced down into the occupied space by the time the air gets to the walls. Discharging warm air into the room at temperatures above 105°F (41°C) usually will set up stratification layers and will not keep the occupants warm if there is a ceiling return because only the top 12" – 24" (300 – 600 mm) of the room will be heated.

The maximum approved discharge air temperature for any Nailor Fan Powered Terminal Unit with supplemental heat is 120°F (49°C). No heater should be applied to exceed this temperature.

#### Electric Heater Selection

To properly select an electric heater, three things must be determined: the heat requirement for the room, the entering air temperature and the desired discharge air temperature. The heat requirement for the room is the sum of the heat loss calculation and the amount of heat required to raise the entering air temperature to the desired room temperature. Usually, the second item is small compared to the first for fan powered terminal units in a return air plenum. MBH can be converted to kW by using the chart or by calculation. There are 3.413 MBH in 1 kW. If using the chart, find the MBH on the left scale, then move horizontally to the right and read kW.

Next, the desired discharge air temperature should be ascertained. This will depend on the type of diffusers that are in the room.

The desired heating airflow for the room can then be calculated using the following equation:

$$cfm = \frac{kW \times 3160}{\Delta t \text{ (discharge air temp - inlet air temp.) } ^\circ F}$$

Assuming 70°F (21°C) supply air temperature to the heater, the room airflow can be selected directly from the chart. Start at the left at the design kW. Move horizontally to the desired discharge air temperature. Then, move vertically down to the cfm at the bottom of the chart.

The kW can be selected directly from the chart. Start at the bottom with the design cfm into the room. Move vertically up to the line that represents the desired discharge air temperature. Then, move left to the kW.

The discharge air temperature can also be selected directly from the chart. Start at the bottom with the design cfm into the room. Move to the left side of the chart and find the design kW. Move horizontally and vertically into the chart until the lines intersect. The intersection will be the desired discharge air temperature. Interpolation between the curves is linear.

**Heater Selection Chart**

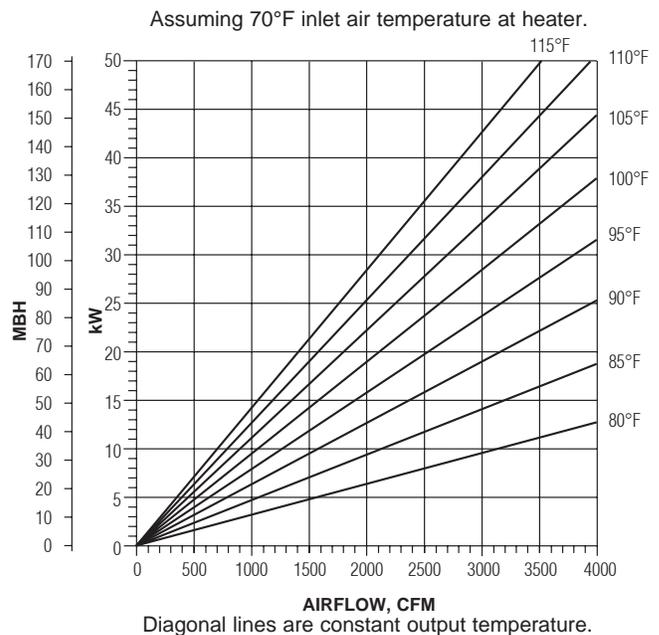

## Optional Terminal Unit Liners For IAQ Sensitive Applications

Nailor offers several options for terminal unit applications where the maintenance of an high Indoor Air Quality is a primary concern. Specific IAQ liners are designed to address applications where the issue of fiberglass insulation eroding and entering the airstream is a concern and/or to reduce the risk of microbial growth.

The sound power levels published in this catalog for fan powered terminal units are based upon testing with standard dual density fiberglass insulation. Dual density insulation is surface treated to prevent erosion and was developed to optimize attenuation for terminal unit applications. Cataloged discharge sound levels for series terminals are not significantly affected by the different liner options, as the fan is mounted on the discharge, however radiated sound levels may escalate depending on the terminal model and liner selection. Contact your Nailor representative for further information.

### Fiber-Free Liner



Fiber-Free liner.

Nailor's Fiber-Free liner is 3/4" (19) thick, closed cell elastomeric foam which totally eliminates fiberglass. The liner has excellent thermal insulating characteristics. The foam does not absorb water, reducing the likelihood of mold or bacterial growth.

The Fiber-Free liner surface is smooth, so that dirt and debris won't accumulate, durable, erosion resistant and washable.

Complies with the following standards and tests:

- NFPA 90A Supplementary materials for air distribution systems.
- ASTM E84 and UL 181 (25/50) Smoke and Flame spread.
- ASTM C1071, G21 and G22 (No bacterial or fungal growth).
- Acoustical attenuation of radiated sound is reduced compared with standard dual density fiberglass insulation.

### Steri-Liner

Steri-Liner is an internal insulation designed to reduce the risk of microbial growth within the terminal. A smooth non-porous facing provides a vapor barrier to moisture and reduces the risk of micro-organisms becoming trapped. It also facilitates cleaning and prevents insulating material erosion. Damage to the liner though, will expose fiberglass particles to the airstream. Acoustic absorption of aluminum foil lined insulation is reduced for discharge sound levels and somewhat increased for radiated sound levels when compared to standard fiberglass insulation.

- 13/16" (21) thick, 4 lb./sq. ft. (64 kg/m<sup>3</sup>) density rigid fiberglass with a fire resistant reinforced aluminum foil-scrim-kraft (FSK) facing on all panels in the mixing chamber.
- Meets the requirements of NFPA 90A and UL 181 for smoke and flame spread and the bacteriological requirements of ASTM C665. Will not support the growth of fungi or bacteria, G21 and G22.
- No exposed edges. All Steri-Liner panels feature full length steel angle inserts and end caps to encapsulate the edges. Nailor's Stealth™ models with Steri-Liner are unique and have been especially designed, utilizing a low density foil back insulation with perforated metal covering in the tuned induction port that maintains cataloged radiated sound levels. No other manufacturer can maintain their cataloged sound levels like Nailor with a foil face liner option.

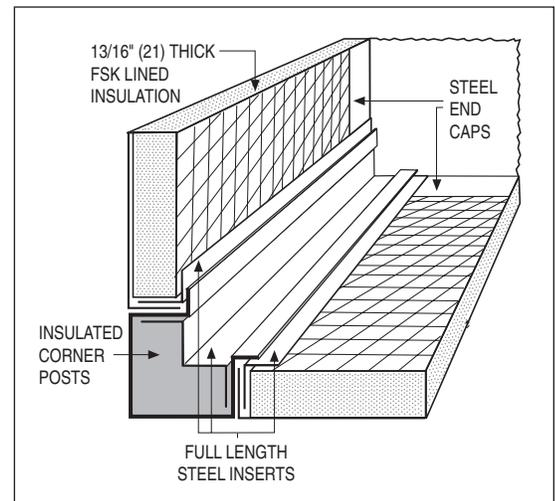

Steri-Liner detail on single duct terminal unit.

### Solid Metal Liner

Nailor also offers a solid inner metal liner that completely isolates the standard insulation from the airstream within the terminal mixing chamber. Solid metal liners offer the ultimate protection against exposure of fiberglass particles to the airstream, all but eliminating the possibility of punctures exposing fiberglass. This option is also resistant to moisture. Fully performance tested for our clients, the Stealth™ series terminals with solid metal liner feature the tuned induction attenuation design described above for Steri-Liner and reduce cataloged radiated sound level ratings. No other terminal manufacturer can make that claim.

### Perforated Metal Liner

Provides additional security and retains standard dual density fiberglass insulation or optional Steri-Liner insulation reducing possibility of long term erosion or breakdown.

## Line Voltage Enclosure Options

- Help ensure NEC clearance requirements

### 90° Option (Code FN2)

The most universal problem encountered on nearly every job is finding adequate space in the ceiling plenum for mounting the mechanical equipment. That is why Nailor researched at length to develop the narrowest series fan powered terminal units available in the industry today. Making the units narrow, increases the chance that they will physically fit between floor joists or into coffers. Unfortunately, the width of the unit is not the only limiting factor. The National Electrical Code calls for a working clearance in front of the controls enclosure. The required clearance is 36" (914) for 0 – 150 VAC and 42" (1067) for 151 – 600 VAC. It is a common practice to mount the controls enclosure flat against the side of the unit; however, that causes the terminal unit footprint to be effectively 42" (1067) wider in order to meet this NEC clearance requirement.

Nailor offers a unique mounting option for the controls enclosure on several models of the series fan powered terminal units. The enclosure can be mounted at 90° on the discharge end of the basic terminal as shown in the photograph. This FN2 option allows the 42" (1067) clearance requirement to run along the side of the unit or along the discharge duct where there is a good chance of clear areas already. This again serves to keep the equipment narrow to fit in the tightest of locations within the ceiling cavity.

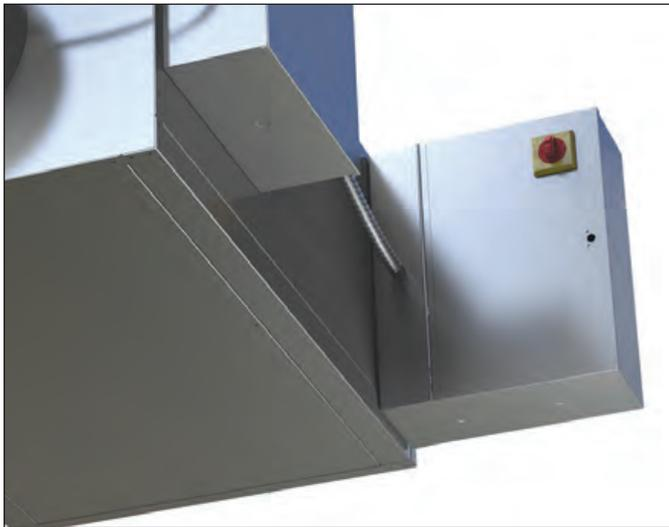

90° Line Voltage Enclosure Option

### Remote Option (Code FN3)

The FN3 line voltage enclosure is an ETL listed option. The FN3 was developed for Nailor fan powered terminal units in order to help meet NEC clearance requirements. Standard enclosures are mounted on the side of the unit and effectively add 42" (1067) to the terminals width footprint. Very often there is insufficient clearance in the ceiling plenum due to physical obstructions to accommodate this. The FN3 provides flexibility in that it may be field positioned in any orientation that provides the NEC clearance requirement. The FN3 enclosure is shipped loose with a 48" (1219) flexible conduit connection to the terminal unit.

## Low Temperature Construction Option (35S Series)

Nailor offers series flow (constant volume) fan powered terminal units with low temperature construction for applications involving low temperature/cold air distribution systems. The fan powered terminal unit is ideal for use with low temperature primary air 40°–48°F (4°–9°C) supplied to the terminal from chilled water/ice storage systems. These low temperature system designs are feasible where off-peak utility rates encourage their use. For instance, ice can be made at night using cheaper power and then used during occupied hours to produce cold air.

The terminal is designed to both handle the low temperature primary air without condensation and effectively mix the cold supply air with warm induced plenum air, resulting in a uniform discharge air temperature. It is common practice to set the fan airflow higher than the maximum primary airflow setting in order to temper the air when used with conventional diffusers in order to optimize performance and eliminate any risk of dumping.

### Construction Features:

- Thermally isolated inlet collar eliminates the risk of condensation forming on the terminal casing inlet.
- Integral perforated mixing baffle on the damper discharge improves mixing efficiency, reduces stratification and improves discharge temperature equalization in the discharge duct.
- Steri-Liner insulation construction provides a foil vapor/thermal barrier, which reduces the risk of moisture damaging the internal insulation and helps eliminate condensation forming on the outside of the terminal unit, which could cause damage in the ceiling space.

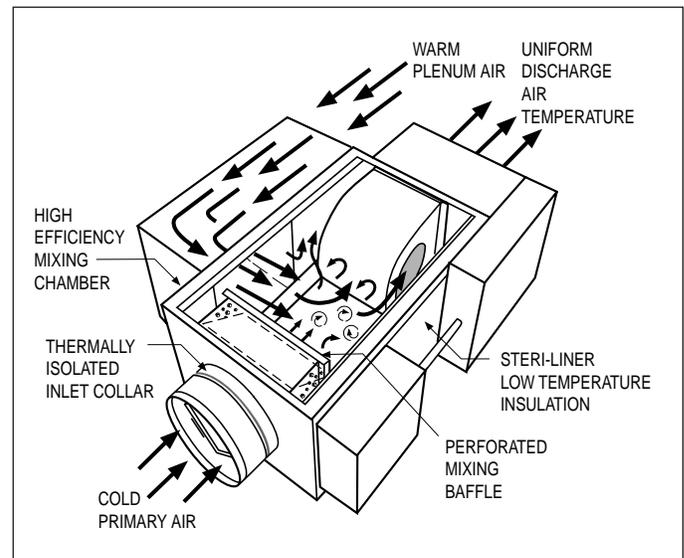

## Standard Control Sequences • Fan Powered Terminal Units • Series Flow

### Nailor EZvav • Pressure Independent

#### Control Sequence N300

**Models: 35S, 35SST, 37S and 37SST**

#### Cooling (Plenum Heat Only), Constant Volume

1. Changeover/Morning Warm-up (Central AHU Heat/Cool): If supply air as measured by the discharge air temperature (DAT) sensor is below 72°F (22.2°C), cool air is said to be available. If supply air is above 76°F (24.4°C), warm air is said to be available.

2. Cool Air Available: As space temperature rises above the cooling setpoint, the controller increases primary airflow. At a space temperature of 2°F (1.1°C) above the cooling setpoint, maximum cooling airflow is maintained. On a decrease in space temperature, the controller reduces airflow. Below cooling setpoint, minimum airflow is maintained.

3. The fan is started during occupied and standby modes and runs continuously at maximum fan speed. The fan induces warm ceiling plenum air as the primary airflow varies and maintains a constant volume to the space. During unoccupied mode, the fan starts on a call for heat only. The fan stops only during unoccupied mode when there is no call for heat. EPIC ECM Motor Only: During standby and unoccupied modes, the fan runs at minimum fan speed.

4. As the space temperature drops below the heating setpoint, the fan continues to recirculate warm ceiling plenum air.

5. Warm Air Available: As space temperature drops below the heating setpoint, the controller increases primary airflow. At a space temperature of 2°F (1.1°C) below the heating setpoint, maximum heating airflow is maintained. On an increase in space temperature, airflow decreases. As space temperature rises above the heating setpoint, minimum heating airflow is maintained.

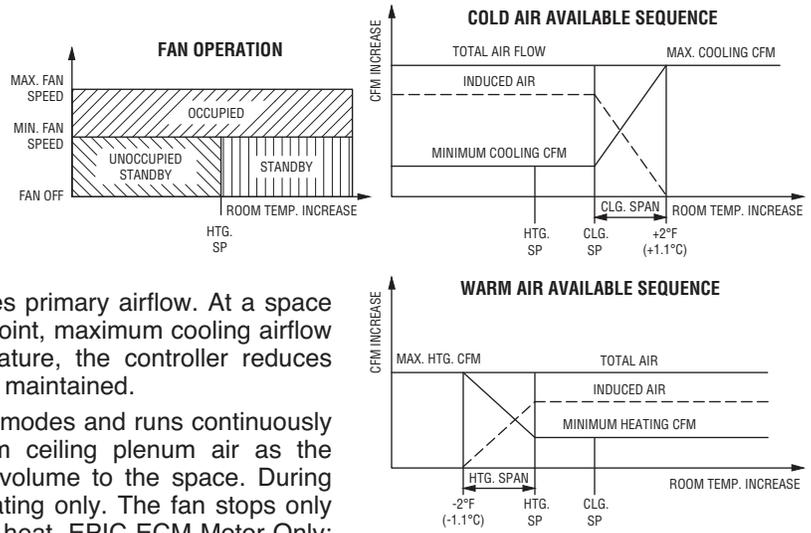

#### Control Sequence N302

**Models: 35SE, 35SEST, 35SW, 35SWST, 37SE, 37SEST, 37SW and 37SWST**

#### Cooling with Modulating Heat, Constant Volume

1. Changeover/Morning Warm-up (Central AHU Heat/Cool): If supply air as measured by the discharge air temperature (DAT) sensor is below 72°F (22.2°C), cool air is said to be available. If supply air is above 76°F (24.4°C), warm air is said to be available. Any time warm air is available, auxiliary heat is locked out.

2. Cool Air Available: As space temperature rises above the cooling setpoint, the controller increases primary airflow. At a space temperature of 2°F (1.1°C) above the cooling setpoint, maximum cooling airflow is maintained. On a decrease in space temperature, the controller reduces airflow. Below cooling setpoint, minimum airflow is maintained.

3. The fan is started during occupied and standby modes and runs continuously at maximum fan speed. The fan induces warm ceiling plenum air as the primary airflow varies and maintains a constant volume to the space. During unoccupied mode, the fan starts on a call for heating only. The fan stops only during unoccupied mode when there is no call for heat. EPIC ECM Motor Only: During standby and unoccupied modes, the fan runs at minimum fan speed.

4. Supplemental Heat: As the space temperature drops below the heating setpoint, the heating output modulates open. As the space temperature rises towards the heating setpoint, the heating modulates closed. If the heating loop is less than 10%, the heating output remains at 0%.

5. If DAT limiting is enabled and a DAT sensor is detected, the discharge air heating setpoint is determined based on the heating loop. The discharge temperature is limited to 15°F (8.3°C) above space temperature up to a maximum of 90°F (32.2°C).

6. Warm Air Available: As space temperature drops below the heating setpoint, the controller increases primary airflow. At a space temperature of 2°F (1.1°C) below the heating setpoint, maximum heating airflow is maintained. On an increase in space temperature, airflow decreases. As space temperature rises above the heating setpoint, minimum heating airflow is maintained.

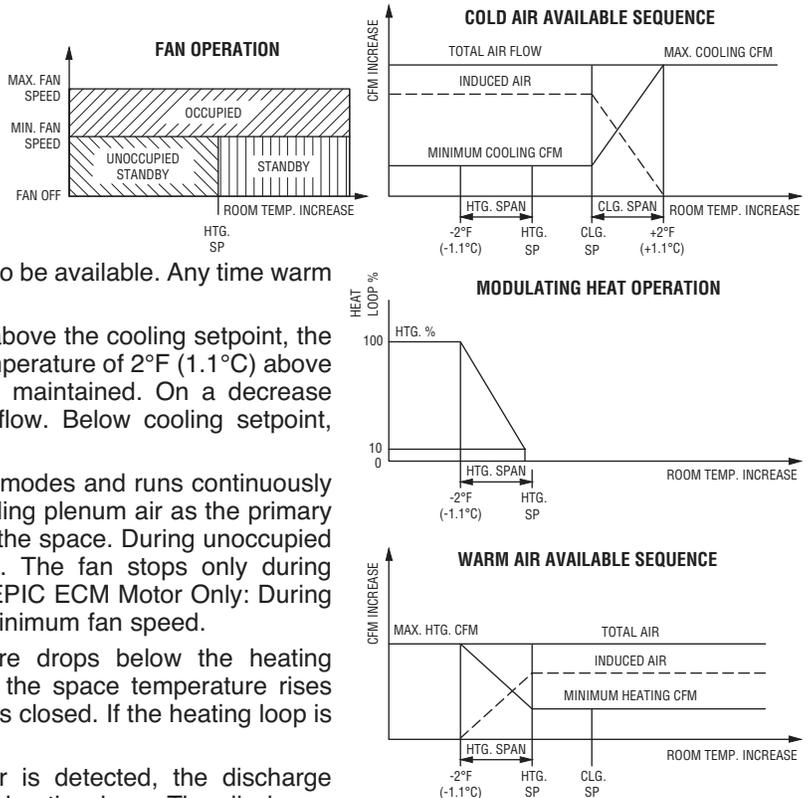

Standard Control Sequences • Fan Powered Terminal Units • Series Flow

Nailor EZvav • Pressure Independent

**Control Sequence N303**

**Models: 35SE, 35SEST, 35SW, 35SWST, 37SE, 37SEST, 37SW and 37SWST**

**Cooling with Floating Heat, Constant Volume**

1. Changeover/Morning Warm-up (Central AHU Heat/Cool): If supply air as measured by the discharge air temperature (DAT) sensor is below 72°F (22.2°C), cool air is said to be available. If supply air is above 76°F (24.4°C), warm air is said to be available. Any time warm air is available, auxiliary heat is locked out.

2. Cool Air Available: As space temperature rises above the cooling setpoint, the controller increases primary airflow. At a space temperature of 2°F (1.1°C) above the cooling setpoint, maximum cooling airflow is maintained. On a decrease in space temperature, the controller reduces airflow. Below cooling setpoint, minimum airflow is maintained.

3. The fan is started during occupied and standby modes and runs continuously at maximum fan speed. The fan induces warm ceiling plenum air as the primary airflow varies and maintains a constant volume to the space. During unoccupied mode, the fan starts on a call for heating only. The fan stops only during unoccupied mode when there is no call for heat. EPIC ECM Motor Only: During standby and unoccupied modes, the fan runs at minimum fan speed.

4. Supplemental Heat: As the space temperature drops below the heating setpoint (heating loop is greater than 70%), the valve is driven open. As the space temperature rises back toward the heating setpoint (heating loop is less than 30%), the valve is driven closed. If the loop is in between, there is no valve action.

5. If DAT limiting is enabled and a DAT sensor is detected, the discharge air heating setpoint is determined based on the heating loop. The discharge temperature is limited to 15°F (8.3°C) above space temperature up to a maximum of 90°F (32.2°C).

6. Warm Air Available: As space temperature drops below the heating setpoint, the controller increases primary airflow. At a space temperature of 2°F (1.1°C) below the heating setpoint, maximum heating airflow is maintained. On an increase in space temperature, airflow decreases. As space temperature rises above the heating setpoint, minimum heating airflow is maintained.

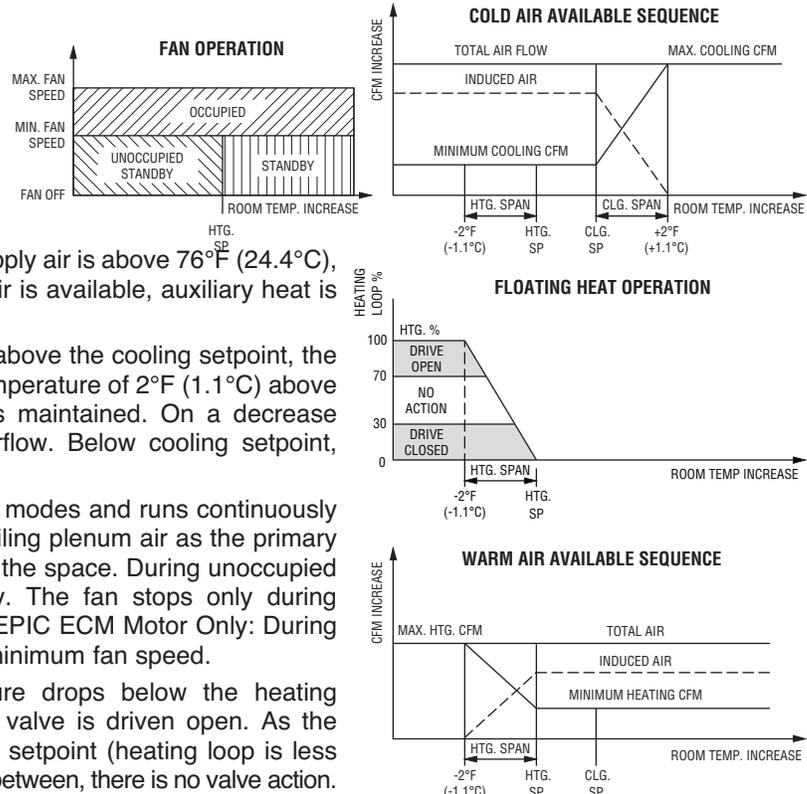

CONTROLS

F

## Standard Control Sequences • Fan Powered Terminal Units • Series Flow

### Nailor EZvav • Pressure Independent

#### Control Sequence N304

**Models: 35SE, 35SEST, 35SW, 35SWST, 37SE, 37SEST, 37SW and 37SWST**

#### Cooling with Binary Heat (Staged Electric or On/Off Hot Water)

1. Changeover/Morning Warm-up (Central AHU Heat/Cool): If supply air as measured by the discharge air temperature (DAT) sensor is below 72°F (22.2°C), cool air is said to be available. If supply air is above 76°F (24.4°C), warm air is said to be available. Any time warm air is available, auxiliary heat is locked out.

2. Cool Air Available: As space temperature rises above the cooling setpoint, the controller increases primary airflow. At a space temperature of 2°F (1.1°C) above the cooling setpoint, maximum cooling airflow is maintained. On a decrease in space temperature, the controller reduces airflow. Below cooling setpoint, minimum airflow is maintained.

3. The fan is started during occupied and standby modes and runs continuously at maximum fan speed. The fan induces warm ceiling plenum air as the primary airflow varies and maintains a constant volume to the space. During unoccupied mode, the fan starts on a call for heating only. The fan stops only during unoccupied mode when there is no call for heat. EPIC ECM Motor Only: During standby and unoccupied modes, the fan runs at minimum fan speed.

4. Supplemental Heat: As the space temperature drops below the heating setpoint, up to 3 stages of electric heat are energized respectively. As the space temperature rises back toward the heating setpoint, heating stages 3, 2 and 1 turn off respectively (Alternatively, an on/off two position spring return hot water valve can be controlled).

5. Warm Air Available: At a space temperature of 2°F (1.1°C) below the heating setpoint, maximum heating airflow is maintained. On an increase in space temperature, airflow decreases. As space temperature rises above the heating setpoint, minimum heating airflow is maintained.

Note: **DO NOT** enable the DAT Discharge Air Temperature limiting feature for binary staged or on/off reheat as short cycling will occur.

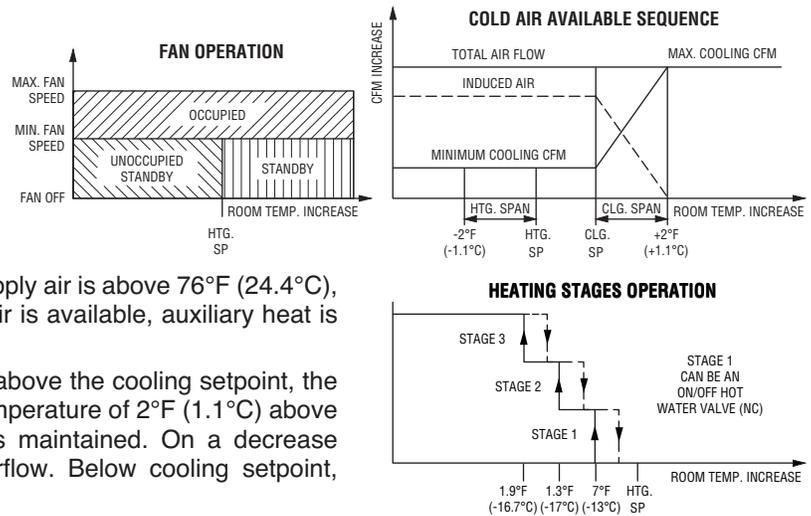

## Standard Control Sequences • Fan Powered Terminal Units • Series Flow

### Model Series 35S, 35SST, 37S and 37SST

#### Analog Electronic • Pressure Independent Occupied Cycle

1. The series terminal fan is directly or indirectly interlocked and energized before or when the central system starts up.

Nailor recommends that the terminal fan is indirectly interlocked by means of an airflow switch (optional) which senses primary air pressure at the inlet. Upon central system start up, the fan in the terminal is automatically energized.

2. On a rise in room temperature, the thermostat sends a signal to increase the flow of cold primary air.

3. As more cold air is supplied to the fan section, less warm air is induced from the ceiling space or plenum.

4. When the room temperature exceeds the set point by 2°F or more, cold airflow is maintained at the maximum setting. The maximum setting is the same as the total fan volume setting.

5. On a decrease in room temperature, the thermostat sends a signal to decrease the flow of cold primary air.

6. As less cold air is supplied to the fan section, more warm air is induced from the ceiling space.

7. When the room temperature and thermostat output signal reach the thermostat set point, the cold airflow is at its minimum limit (usually zero) and the fan is supplying the maximum volume of induced air.

8. If room temperature continues to drop, an optional heating coil may be energized.

9. When the optional airflow switch is supplied and the central system is turned off (night-time or weekend), the series terminal fan is shut down upon loss of primary air.

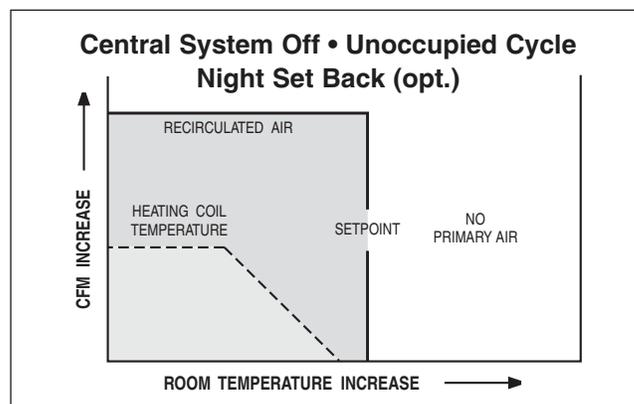
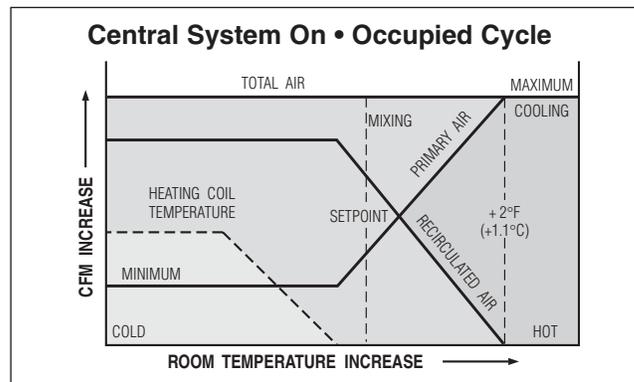

## Standard Control Sequences • Fan Powered Terminal Units • Series Flow

### Model Series 35S, 35SST, 37S and 37SST

#### Analog Electronic Sequences

Description	Code
Cooling (continuous operation)	A1
Cooling w/morning warm-up (continuous operation)	A2
Cooling w/staged electric, auxiliary or on-off hot water heat (continuous operation)	A3
Cooling w/proportional heat (continuous operation)	A4
Cooling w/night cycle	A5
Cooling w/morning warm-up and night cycle	A6
Cooling w/staged electric, auxiliary or on-off hot water heat and night cycle	A7
Cooling w/proportional heat and night cycle	A8
Cooling w/auto night shutdown	B1
Cooling w/morning warm-up and auto night shutdown	B2
Cooling w/staged electric, auxiliary or on-off hot water heat and auto night shutdown	B3
Cooling w/proportional heat and auto night shutdown	B4
Cooling w/auto night setback cycle	B5
Cooling w/morning warm-up and auto night setback cycle	B6
Cooling w/staged electric, auxiliary or on-off hot water heat and auto night setback cycle	B7
Cooling w/proportional heat and auto night setback cycle	B8
Cooling w/staged electric, auxiliary or on-off hot water heat, auto night setback cycle and morning warm-up	B9
Cooling w/proportional heat, auto night setback cycle and morning warm-up	B10
Cooling w/staged electric, auxiliary or on-off hot water heat and morning warm-up (continuous operation)	B23
Cooling w/proportional heat and morning warm-up (continuous operation)	B24
Cooling w/staged electric, auxiliary or on-off hot water heat, auto night shutdown and morning warm-up	B25
Cooling w/proportional heat, auto night shutdown and morning warm-up	B26
Cooling w/auto changeover (continuous operation)	B13
Cooling w/staged electric, auxiliary or on-off hot water heat and auto changeover (continuous operation)	B17
Cooling w/proportional heat and auto changeover (continuous operation)	B18
Cooling w/auto changeover and auto night shutdown	B15
Cooling w/staged electric, auxiliary or on-off hot water heat, auto changeover and auto night shutdown	B16
Cooling w/proportional heat, auto central heating changeover and auto night shutdown	B22

#### Sequence Notes:

##### Morning Warm-Up

A duct stat is mounted in the terminal inlet. Upon sensing a central system supply air temperature above 77°F (25°C), the primary air damper drives to a full open position. Optional terminal supplementary heat is locked out. Upon sensing cool air, the terminal reverts to daytime operation.

##### Auxiliary or On-off Hot Water Heat

Control relay provides a 24 VAC output signal for operation of valve (10 VA maximum by others).

##### Proportional Hot Water Heat

Thermostat heating output provides an 0 – 10 Vdc reverse acting control signal to proportional valve (by others). Closed at 0 Vdc and fully open at 10 Vdc (10 mA maximum).

##### Night Cycle

An airflow switch de-energizes fan upon loss of primary (central system) air. Upon a call for heat, the thermostat will override the airflow switch and cycle the unit fan followed by any supplementary heat intermittently to maintain day set point temperature.

##### Auto Night Shutdown

An airflow switch de-energizes fan upon loss of primary (central system) air and locks out any optional supplementary heat.

##### Auto Night Setback

An airflow switch de-energizes fan upon loss of primary (central system) air and activates the night side of the thermostat. Primary air damper cycles closed. Upon a call for heat, the thermostat will override the airflow switch and cycle the unit fan and optional supplementary heat intermittently to maintain a lower energy saving setback temperature.

##### Auto Changeover

(Central Heat/Cool Systems)

These sequences incorporate a duct stat and heat/cool thermostat. Upon sensing a central system supply air temperature above 77°F (25°C), the heating side of the thermostat is activated and the damper throttling action is reversed. Warm central air is modulated between minimum and maximum set points.

##### Optional Strategies

Night setback, night shutdown and primary damper overrides may be initiated by external 24 VAC inputs and/or dry contact closures.

Consult your Nailor representative for non-standard control sequences.

## Standard Control Sequences • Bypass Terminal Units

### Analog Electronic • Pressure Dependent

#### Control Sequence E2

##### Cooling Only

Central system supplies cool air. On a rise in room temperature above set point, the bypass damper will slowly modulate open, increasing the flow of air to the room, closing the bypass at the same time. On a fall in room temperature below set point, the bypass damper will modulate closed, reducing the flow of cool air into the room and opening the bypass at the same time. A mechanical air volume minimum stop is provided (field set).

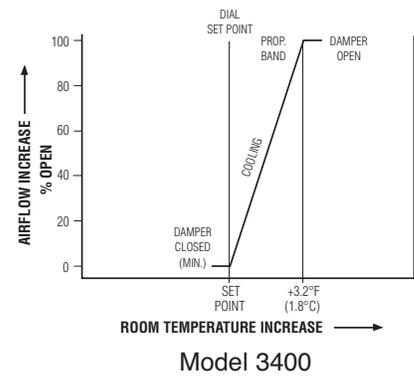

#### Control Sequence E3

##### Automatic Heating/Cooling Changeover

This arrangement is for systems supplying cool air in summer and hot air in winter. A duct temperature sensor senses inlet temperature and automatically reverses control action when supply air is above 78°F (26°C). A mechanical air volume minimum stop is provided (field set).

##### Cooling Mode:

Supply air system in cooling mode (below 75°F (24°C)). On a rise in room temperature above set point, the bypass damper will modulate open, increasing the flow of cool air to the room, closing the bypass at the same time. On a fall in room temperature below set point, the bypass damper will modulate closed, reducing the flow of cool air into the room and opening the bypass at the same time.

##### Heating Mode:

Supply air system in heating mode (above 78°F (26°C)). On a rise in room temperature above set point, the bypass damper will modulate closed, reducing the flow of warm air into the room to maintain set point and opening the bypass. On a fall in room temperature below set point, the bypass damper will modulate open, increasing the flow of warm air into the room to maintain the set point and closing the bypass at the same time.

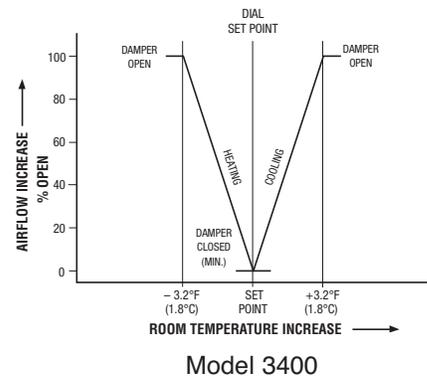

#### Control Sequence E4

##### Cooling with On/Off Auxiliary Heat (Perimeter) or Hot Water Reheat

Central system supplies cool air. On a rise in room temperature above set point, the bypass damper will slowly modulate open, increasing the flow of air to the room, closing the bypass at the same time. On a fall in room temperature below set point, the bypass damper will modulate closed, reducing the flow of cool air into the room and opening the bypass at the same time.

If room temperature continues to fall, the thermostat will energize the control relay/valve of the perimeter heating or hot water valve for reheat. A mechanical air volume minimum stop is provided (field set).

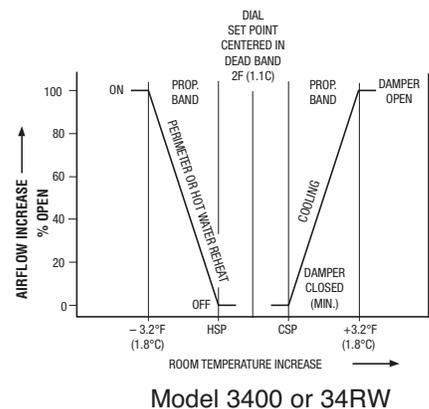

## Standard Control Sequences • Fan Powered Terminal Units • Series Flow

### Model Series 35S, 35SST, 37S and 37SST

### Pneumatic • Pressure Independent

#### Occupied Cycle

1. The series terminal fan is directly or indirectly interlocked and energized before or when the central system starts up.

Nailor recommends that the terminal fan is indirectly interlocked by means of an airflow switch (optional) which senses primary air pressure at the inlet. Upon central system start up, the fan in the terminal is automatically energized.

2. On a rise in room temperature, the thermostat sends a signal to increase the flow of cold primary air.

3. As more cold air is supplied to the fan section, less warm air is induced from the ceiling space or plenum.

4. When the room temperature exceeds the set point by 2°F or more, cold airflow is maintained at the maximum setting. The maximum setting is the same as the total fan volume setting.

5. On a decrease in room temperature, the thermostat sends a signal to decrease the flow of cold primary air.

6. As less cold air is supplied to the fan section, more warm air is induced from the ceiling space.

7. When the room temperature and thermostat output signal reach the thermostat set point, the cold airflow is at its minimum limit (usually zero) and the fan is supplying the maximum volume of induced air.

8. If room temperature continues to drop, an optional heating coil may be energized.

9. When the optional airflow switch is supplied and the central system is turned off (night-time or weekend), the series terminal fan is shut down upon loss of primary air.

#### Pneumatic Options

1. Night Shutdown (Airflow Switch). Accessory code: QK.

An airflow switch de-energizes fan upon loss of primary (central) air (indirect fan interlock). The terminal fan will remain off until the primary air is restored.

2. Night Shutdown (P.E. Switch). Accessory code: QL.

A pneumatic electric switch de-energizes the fan upon loss of main air. Primary air fan must be shut down. The terminal fan will remain off until the main air is restored. Units with electric heat require reverse acting thermostats to prevent heat operation when terminal fan is off.

3. Night Setback (P.E. and Airflow Switch). Acc. code: QM.

Airflow switch de-energizes fan upon loss of primary (central) air. A P.E. switch overrides the airflow switch upon a call for heating and will cycle the unit fan followed by the supplementary heat intermittently in response to the night setback thermostat.

4. Night Setback (Two P.E.'s). Accessory code: QN.

A P.E. switch de-energizes fan upon loss of main air. Primary air fan must be shut down. A second P.E. switch provides an override upon a call for heating and will cycle the unit fan and supplementary heat in response to a separate pneumatic signal or night setback thermostat.

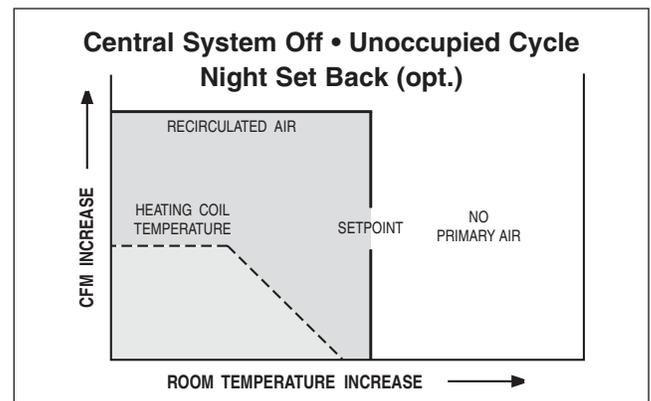
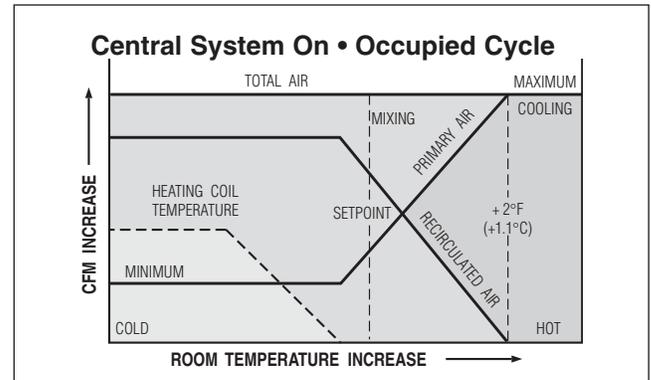

Pneumatic Sequence (Pressure Independent)			Code
Thermostat Action	Damper Fail Position	Electric or Hot Water Heat Option	
D.A.	NO	YES	1P3
R.A.	NO	YES	2P3
D.A.	NC	YES	3P3
R.A.	NC	YES	4P3

## Fan Powered Terminal Units • 37S Series

### Model 37S • Series Flow (Constant or Variable Volume) Low Profile

- Furnish and install constant or variable volume low profile series fan powered terminal units of the sizes and capacities as indicated on the drawings. Maximum height shall be 11" (279). Units shall be pressure independent with (digital electronic, analog electronic, pneumatic) controls. Units shall be manufactured by **Nailor Industries Inc. Model 37S**.
- The entire terminal unit shall be designed and built as a single unit. The units shall be provided with a primary variable air volume damper that controls the air quantity in response to a (pneumatic, electronic) thermostat. The space limitations shall be reviewed carefully to ensure that all units will fit into the space allowed.
- Unit casing shall be 20 ga. (1.00) galvanized steel and 20 ga. (1.00) galvanized steel panels. Unit shall be fully lined with fiberglass insulation which shall be 1/2" (13) thick dual density insulation complying with NFPA 90 for fire and smoke resistivity and UL 181 for erosion. Any cut edges of insulation shall be coated with NFPA 90 approved sealant.
- Unit casing shall have access panels, on the bottom and top for easy access to motor and blower assembly and for maintenance and replacement of parts without disturbing duct connections. The unit shall be rated to operate in left hand or right hand mode by turning the unit over. Access panels shall be attached to casing with (screws, quick acting latches, hinges). Casing leakage shall not exceed 2% of terminal rated airflow at 0.5" w.g. (125 Pa) interior casing pressure. All high side casing joints shall be sealed with approved sealant and high side casing leakage shall not exceed 2% of terminal rated airflow at 3" w.g. (750 Pa).
- Units shall have round inlets for the primary air connections and shall have a 6" (152) deep inlet duct collar for field connection. The outlets shall be rectangular and suitable for flanged duct connections. Casing shall have mounting area for hanging by sheet metal straps from a concrete slab.
- The damper shall be of rectangular, multiple inclined opposed blade construction and designed to operate on a 45° arc. Blades shall be minimum 16 ga. (1.61) galvanized steel, single thickness construction with heavy duty gasket glued to the blades. The blades shall be screwed through the damper shaft to ensure that no slippage occurs. Blade shafts shall pivot on corrosion free bearings. Damper leakage shall not exceed 2% of the terminal rated cfm at 3" w.g. (750 Pa) inlet static pressure.
- Entire terminal unit shall be factory assembled with (pneumatic, electronic) controls. All components including all controls except the room thermostat and (pneumatic piping, field wiring) shall be factory installed and mounted with the unit.
- Provide a (digital electronic, analog electronic, pneumatic) flow control device that will limit the maximum and minimum airflow to that scheduled on the drawings. Airflow limits shall be factory set. Thermostat signal shall reset the flow control device to adjust primary airflow to match load requirements. Control of the terminal unit shall be pressure independent.
- The terminal unit shall be capable of operation as described herein with inlet static pressure of 0.05" w.g. (12 Pa) at full cooling with no mixing of induced and primary air. (The sequence of operation should be described here, if not part of the temperature controls specifications). Mixing of the primary and secondary airstreams shall be such that no more than 2.5°F (1.4°C) variation shall exist in the discharge airstream for each 20°F (11.1°C) of difference between the primary and secondary airstreams.
- Blower casings shall be constructed of heavy gauge coated steel. Blower wheel shall be forward curved centrifugal type, dynamically balanced and driven by direct drive, single speed split capacitor motors. Motors shall be suitable for 120, 208, 240, or 277 volts single phase power. Motors shall have built-in overload protection, bearings capable of low rpm oiling, permanently oiled bearings and a built-in anti-backward rotation device. Fan assembly shall be mounted so as to isolate the casing from the motor and blower

vibration at no less than four points. Isolation shall be supplied at the motor and at the blower mounting points.

- An electronic motor speed controller sized and designed for the specific blower motor combination shall be provided to allow infinitely adjustable fan speed from the minimum voltage stop to the line voltage signal to the motor. A minimum voltage stop shall be employed to ensure that fan cannot run in stall mode.
- Units shall incorporate a single point electrical (and pneumatic) connection for the entire unit. All electrical components shall be UL or ETL listed or recognized and installed in accordance with the National Electrical Code. All electrical components shall be mounted in a control box. The entire assembly shall be ETL listed (cETL in Canada) and so labeled.
- All sound data shall be compiled in an independent laboratory and in accordance with the latest version of AHRI Standard 880. All units shall be AHRI certified and bear the AHRI certification label.
- Unit maximum radiated sound power levels at 1.0" w.g. (249 Pa) inlet pressure and 0.25" w.g. (63 Pa) discharge static pressure shall not exceed the values in Tables 1 and 2 at the specified airflow. No credit or reduction shall in any way be considered for room, plenum, ceiling and/or similar item effects.

Unit Size	Airflow		Sound Power Octave Band Center Frequency (Hz.)						
	cfm	l/s	2	3	4	5	6	7	
			125	250	500	1000	2000	4000	
1	300	142	60	55	50	48	45	44	
2	700	330	62	59	54	55	50	51	
3	900	425	69	62	58	58	52	53	
4	1450	684	70	66	64	60	54	52	

**Table 1.** Maximum Radiated Sound Power Levels Full Cooling (Fan on and 100% primary air)

Unit Size	Airflow		Sound Power Octave Band Center Frequency (Hz.)						
	cfm	l/s	2	3	4	5	6	7	
			125	250	500	1000	2000	4000	
1	300	142	56	50	46	43	34	26	
2	700	330	64	57	54	54	45	37	
3	900	425	67	59	56	56	49	40	
4	1450	684	71	63	61	57	47	39	

**Table 2.** Maximum Radiated Sound Power Levels Full heating (Fan only)

- Unit maximum discharge sound power levels at 1.0" w.g. (249 Pa) inlet pressure and 0.25" w.g. (63 Pa) discharge static pressure shall not exceed the values in Table 3 at the specified airflow. No credit or reduction shall in any way be considered for room, downstream duct, elbows and/or similar item effects.

Unit Size	Airflow		Sound Power Octave Band Center Frequency (Hz.)						
	cfm	l/s	2	3	4	5	6	7	
			125	250	500	1000	2000	4000	
1	300	142	67	60	52	44	38	34	
2	700	330	66	62	59	55	51	47	
3	900	425	77	73	67	66	63	60	
4	1450	684	76	72	70	70	66	64	

**Table 3.** Maximum Discharge Sound Power Levels Full cooling (Fan on and 100% primary air)

### Motor: ECM (Substitute the following paragraph:)

- Blower casings shall be constructed of heavy gauge coated steel. Blower wheel shall be forward curved centrifugal type, dynamically balanced and driven by Electronically Commutated Motor(s). Motor(s) shall be suitable for 120 or 208 or 240 or 277 volt single phase power. Fan airflow volume shall be factory set. Fan assembly shall be mounted so as to isolate the casing from the motor and blower vibration at no less than four points. Isolation shall be supplied at the motor and at the blower mounting points. A gasketed backdraft damper shall be included on the fan discharge to reduce primary air leakage back into the plenum space.

Fan Powered Terminal Units • 37S Series

Model 37S • Series Flow (Constant or Variable Volume) Low Profile (continued)

OPTIONS

"STEALTH™"

(Substitute the following paragraphs:)

1. Furnish and install series flow (constant or variable volume) fan powered terminal units of the sizes and capacities as indicated on the drawings. Units shall be pressure independent with (digital electronic, analog electronic, pneumatic) controls. Units shall be manufactured by **Nailor Industries Inc. Model 37SST "Stealth™"**.

4. Unit maximum radiated sound power levels at 1.0" w.g. (249 Pa) inlet pressure and 0.25" w.g. (63 Pa) discharge static pressure shall not exceed the values in Tables 4 and 5 at the specified airflow. No credit or reduction shall in any way be considered for room, plenum, ceiling and/or similar item effects.

Unit Size	Airflow		Sound Power Octave Band Center Frequency (Hz.)						
	cfm	l/s	2	3	4	5	6	7	
			125	250	500	1000	2000	4000	
1	300	142	58	54	47	42	38	33	
2	700	330	65	60	54	52	49	46	
3	900	425	67	60	54	50	43	40	
4	1450	684	70	62	56	51	48	46	

Table 4. Maximum Radiated Sound Power Levels Full Cooling (Fan on and 100% primary air)

Unit Size	Airflow		Sound Power Octave Band Center Frequency (Hz.)						
	cfm	l/s	2	3	4	5	6	7	
			125	250	500	1000	2000	4000	
1	300	142	55	51	44	38	33	26	
2	700	330	62	55	52	48	39	33	
3	900	425	64	58	55	53	41	34	
4	1450	684	67	58	53	49	43	36	

Table 5. Maximum Radiated Sound Power Levels Full Heating (Fan only)

15. Unit maximum discharge sound power levels at 1.0" w.g. (249 Pa) inlet pressure and 0.25" w.g. (63 Pa) discharge static pressure shall not exceed the values in Table 6 at the specified airflow. No credit or reduction shall in any way be considered for room, downstream duct, elbows and/or similar item effects.

Unit Size	Airflow		Sound Power Octave Band Center Frequency (Hz.)						
	cfm	l/s	2	3	4	5	6	7	
			125	250	500	1000	2000	4000	
1	300	142	66	62	54	46	41	36	
2	700	330	66	62	59	55	51	46	
3	900	425	77	72	67	66	62	59	
4	1450	684	75	71	70	69	66	63	

Table 6. Maximum Discharge Sound Power Levels Full cooling (Fan on and 100% primary air)

Electric Heat

(Substitute the following paragraphs:)

1. Furnish and install series flow (constant or variable volume) fan powered terminal units with integral electric heat of the sizes and capacities as indicated on the drawings. Units shall be pressure independent with (pneumatic, analog electronic, digital electronic) controls. Units shall be manufactured by **Nailor Industries Inc. Model 37SE or 37SEST "Stealth™"** (select one).

12. An electric heater shall be factory mounted and pre-wired as an integral package with the fan powered terminal unit. Heaters shall be sized as shown on the drawings. The entire assembly including the electric heater shall be ETL listed (cETL in Canada) for zero clearance and so labeled and shall meet all requirements of the latest National Electrical Code (Canadian Electrical Code, CSA Standard C22.1). The

unit with the heater mounted shall be listed and rated to be turned over for either left or right hand configuration. The unit shall have a single point electrical (and pneumatic) connection. Heater casing and panel shall be a minimum of 20 gauge galvanized steel. Each heater shall be complete with primary disc type automatic high limit, contactors as required, ground terminal, fan relay for interlocking the heater and fan and high grade nickel chrome alloy resistance wire. Element wires shall be suspended in insulators designed to expose the entire face area of the wire thereby eliminating hot spots. Each heater shall be supplied with factory supplied and pre-wired branch circuit fusing as required by NEC and UL. Circuiting and fusing shall also be in accordance with the circuiting requirements as shown on the plans. Additional accessories shall include (control transformer, circuit fusing, disconnect switch, electric step controller, pneumatic electric switches) for staging the heater.

(Additional performance requirements that you might want to include can be found in the electric heater section). The electric heater shall be located on the discharge side of the fan so as not to add heat to the motor and shorten its expected lifetime.

Heater voltage and stages to be as follows:

- 0 to 5.0 kW ..... 277V/1 phase, 1 Step
- 5.1 kW and up ..... 480V/3 phase, 1 Step

Hot Water Heating Coils

(Substitute the following paragraphs:)

1. Furnish and install series flow (constant or variable volume) fan powered terminal units with integral hot water coils of the sizes and capacities as indicated on the drawings. Units shall be pressure independent with (digital electronic, analog electronic, pneumatic) controls. Units shall be manufactured by **Nailor Industries Inc. Model 37SW or 37SWST "Stealth™"** (select one).

12. A hot water coil shall be factory mounted as an integral package with the fan powered terminal unit. Hot water coils shall be sized as shown on the drawings. The entire assembly including the hot water coil shall be ETL listed (cETL in Canada) for zero clearance and so labeled and shall meet all requirements of the latest National Electrical Code. The unit shall have a single point electrical (and pneumatic) connection. Water coil casing and panels shall be a minimum of 20 ga. (1.00) galvanized steel. Access panels shall be supplied on the top and bottom of the unit for easy access to the coil for inspection and cleaning. All copper, including the headers and return bends, shall be encased to eliminate heat loss during heating sequence and heat gain during cooling sequence. Coils shall be 1, 2 or 3 row as required and heating capacities shall be as shown on the plans. Coils shall have aluminum plate fins spaced 10 per inch and bonded to 1/2" (13) O.D. copper tubes. Copper connections shall be sweat. All coils shall be tested at a minimum of 300 psi (2.1 MPa) under water to produce a guaranteed working pressure of 250 psi (1.7 MPa). Controls and valves for the hot water coils shall be field mounted. Heating coils shall be located on the discharge side of the fan so as not to add heat to the motor and shorten its expected lifetime.

EZvav Digital Controls

1.1 ASC VAV BACnet CONTROLLERS

A. Digital VAV Controllers shall be responsible for monitoring and controlling directly connected VAV Terminals as required. Controllers shall include fully adjustable analog outputs and digital outputs as required utilizing a proportional plus integral control loop to control damper, electric heat and hot water coils for the purpose of maintaining user setpoints. Each controller shall be classified as a native BACnet device, conforming to the BACnet Advanced Specific Controllers (B-ASC) profile, ANSI/ASHRAE BACnet Standard 135.

B. The VAV controller shall be available with integrated applications (based on model) for Single Duct, Dual Duct, and Fan Powered terminal units, including any of the following as required by the control sequence. For Single/Dual Duct terminals: Cooling Only, Cooling/Heating with Changeover and Morning Warm up. For Fan Powered terminals: Cooling with Reheat/Supplementary Heat, Heating coil operation may be with analog, floating or binary control as required.

SUGGESTED SPECIFICATIONS



## Fan Powered Terminal Units

### 37S Series

#### OPTIONS (continued)

C. The controller shall be fully configurable via the Digital Display Sensor, including communication parameters (instance, MAC, baud) and application settings (K-factor, flow limits, box configuration, reheat or fan type, default user setpoints, etc.), without any specific PC-based software. VAV controllers shall not require the use of a personal computer and PC based software and/or any interface modules.

D. The VAV controller shall be capable of being balanced from the Digital Room Sensor without any specific pc-based software.

E. The controller shall have integrated MS/TP communications. The communication port shall have network protection bulbs and integrated end-of-line (EOL) terminations.

F. The controller shall have an integrated actuator rated at 40 in-lbs. Connection to the damper shall be with a v-bolt clamp, accepting 3/8" to 5/8" damper shaft sizes. The actuator shall travel 0 to 95 degrees with adjustable end stops at 45 and 60 degrees of rotation. The actuator shall have an integrated gear disengagement mechanism.

G. The controller shall have an integrated transducer pressure sensor for airflow measurement. The sensor shall have a range of 0-2"wc, consuming and accurate to 4.5% of reading or 0.0008"wc, whichever is greater.

H. The controller shall have a Dedicated Room Sensor port for direct interface to a Digital Display Room Sensor or Discrete Room Sensor. The controller shall have the ability of detecting if a sensor has been connected to the port and identify its type, either digital display or discrete. Sensors shall be hot-swappable without powering down the controller. Sensor information via the ports shall not consume any of the devices terminated input capacity.

I. The controller shall have screw terminal blocks that can accommodate wire sizes 14-22 AWG. Terminals shall be color coded: black terminals for power, green terminals for input and outputs, and grey terminals for twisted-shielded-pair communication.

J. The power supply for the controller shall be 24 volts AC (-15%, +20%) power. Voltage below the operating range of the system shall be considered an outage.

#### 1.2 DIGITAL ROOM SENSOR

A. The Digital Display Room Sensor (thermostat) shall provide space condition measurements and indications, including temperature and local motion/occupancy (optional), and user setpoint adjustments.

B. The Digital Room Sensor shall connect directly to the controller and shall not utilize any of the hardware I/O points of the controller. The Digital Display Room Sensor shall be able to be located up to 75' from the controller.

C. The Digital Display Room Sensor shall provide a Temporary Network Interface jack, field accessible without uninstalling the sensor, for connection to the BACnet MS/TP communication trunk to which the devices connected. The Digital Display Room Sensor, the connected controller, and all other devices on the BACnet network shall be accessible through the temporary communication jack. Microprocessor based sensors whose port only allows communication with the controller to which it is connected shall not be acceptable.

D. The Digital Display Room Sensor shall have an integrated sensor for temperature measurement as standard and a second integrated sensor for motion/occupancy (optional).

E. User/Occupant setpoints may be adjusted via the Digital Display Room Sensor.

F. The Digital Display Room Sensor shall have pre-configured menus for all control sequences allowing access to communication and application parameters.

G. The Digital Display Room Sensor shall have two levels of password protection: One level to protect user setpoint adjustment, and one level to protect configuration menu parameters. Passwords shall be at least 4 digits in length.

### Model 35N • Parallel Flow (Variable Volume)

1. Furnish and install variable volume parallel fan powered terminal units of the sizes and capacities as indicated on the drawings. Units shall be pressure independent with (digital, analog electronic, pneumatic) controls. Units shall be manufactured by **Nailor Industries Inc. Model 35N**.

2. The entire terminal unit shall be designed and built as a single unit. The units shall be provided with a primary variable air volume damper that controls the air quantity in response to a (thermostat or digital controller/zone sensor). The units shall also include a fan that sequences on and off in response to the (thermostat or digital controller/zone sensor). The space limitations shall be reviewed carefully to ensure that all units will fit into the space allowed.

3. Unit casings shall be 20 ga. (1.00) galvanized steel. Unit shall be fully lined with fiberglass insulation which shall be at least 3/4" (19) thick dual density insulation complying with NFPA 90 for fire and smoke resistivity and UL 181 for erosion. Any cut edges of insulation shall be coated with NFPA 90 approved sealant.

4. The terminal casing shall have full size bottom access panels for easy access to motor and blower assembly and for maintenance and replacement of parts without disturbing duct connections. Access panels shall be attached to casing with (screws, 1/4 turn fasteners).

5. Units shall have round inlets for the primary air connections and shall have a minimum 6" (152) deep inlet duct collar for field connection. Models with no heat or electric heat shall have rectangular outlets suitable for flanged duct connections. Models with hot water coils shall have a discharge opening with slip and drive connection. Casing shall have mounting area for hanging by sheet metal straps from a concrete slab.

6. The damper shall be round and of laminated 2 x 20 ga. (1.00) galvanized steel construction with a peripheral gasket and a solid steel 1/2" (13) diameter shaft, pivoted in self-lubricating bronze oilite bearings. Damper leakage shall not exceed 2% of the terminal rated airflow at 3" w.g. (750 Pa) inlet static pressure.

7. Entire terminal unit shall be factory assembled with (digital, analog electronic, pneumatic) controls. All components including all controls except the room (thermostat or zone sensor) and (pneumatic piping, field wiring) shall be factory installed and mounted with the unit.

8. Provide a (digital, analog electronic, pneumatic) flow control device that will limit the maximum and minimum airflow to that scheduled on the drawings. Control of the terminal unit shall be pressure independent.

9. The sequence of operation should be described here, if not part of the temperature controls specifications.

10. Blower casings shall be constructed of heavy gauge coated steel. Blower wheel shall be forward curved centrifugal type, dynamically balanced and driven by direct drive, single speed split capacitor motors. Motors shall be suitable for 120 or 208 or 240 or 277 volt single phase power. Motors shall have built-in overload protection, bearings capable of low rpm oiling, permanently oiled bearings and a built-in, anti-backward rotation device. Fan assembly shall be mounted so as to isolate the casing from the motor and blower vibration at no less than four points. Isolation shall be supplied at the motor and at the blower mounting points. A gasketed backdraft damper shall be included on the fan discharge to preclude primary air leakage back into the plenum space.

11. A solid state SCR fan speed controller sized and designed for the specific blower motor combination shall be provided to allow infinitely adjustable fan speed from the minimum voltage stop to the line voltage signal to the motor. A minimum voltage stop shall be employed to ensure that fan cannot run in stall mode.

12. Units shall incorporate a single point electrical (and pneumatic) connection for the entire unit. All electrical components shall be ETL listed or recognized and installed in accordance with the National Electrical Code. All electrical components shall be mounted in a control box. The entire assembly shall be ETL listed and labeled to meet UL 1995 and CSA C22.2 No. 236.