



Nailor[®]

FAN FILTER UNITS

92FFU



92FFU

Fan Filter Units

Redefining Clean Air Solutions



In an era where air cleanliness is essential in critical environments, Nailor presents the cutting-edge 92FFU Fan Filter Unit, designed to elevate your indoor air quality standards to unprecedented levels. Engineered with precision and innovation, this revolutionary filtration system promises to set a new industry benchmark for efficient and effective air purification.

With the 92FFU, Nailor continues its tradition of excellence by combining advanced technology, exceptional performance, and user-friendly design. Whether you're striving to maintain pristine cleanrooms, improve indoor air quality in healthcare facilities, or create a healthier workspace, this state-of-the-art Fan Filter Unit is your ultimate solution.

The new Nailor 92FFU expands our lineup by offering groundbreaking features, exceptional benefits, and unmatched performance. Elevate your air quality standards and breathe easy with Nailor.

Applications



Cleanrooms/Hospitals

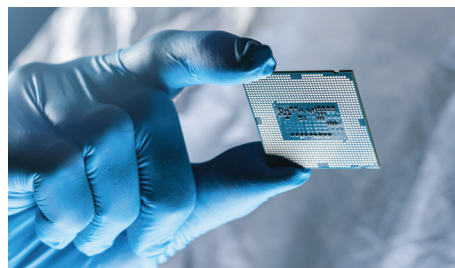

Microelectronics Manufacturing



Pharmaceutical



Laboratories

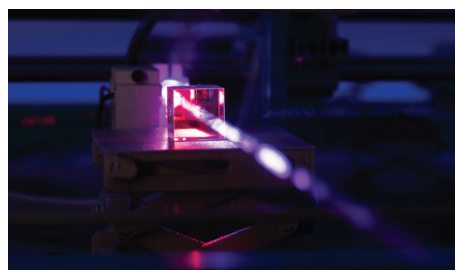

Laser/Optic Industries



Aerospace

Inlet Options

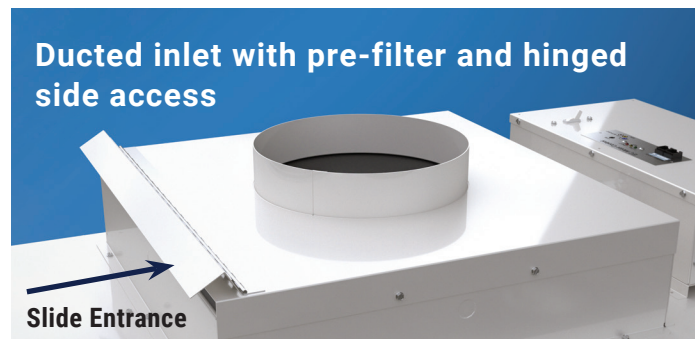
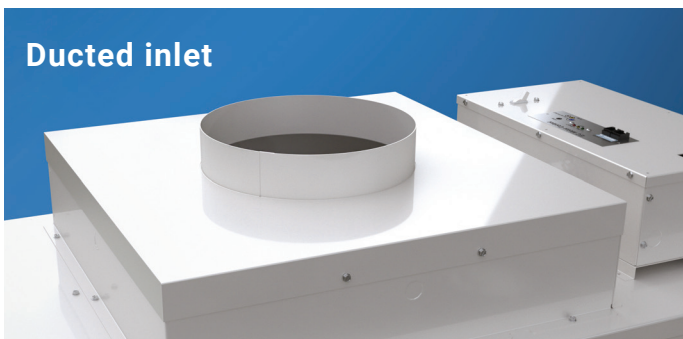
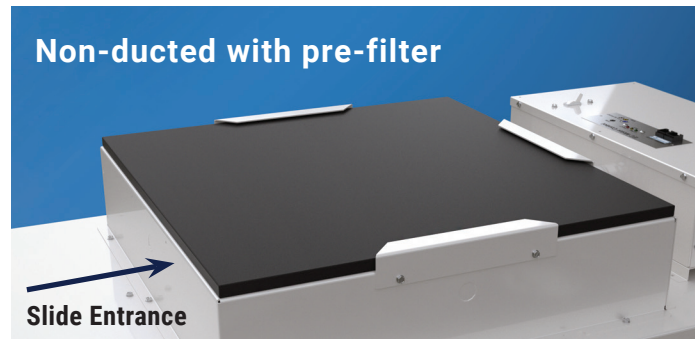

Standard Features

- **Roomside Removable HEPA Filter Design** – eliminates the need to access the ceiling plenum.
- **Top Side Removable motor/blower** – for easy access and maintenance with optional room side removable motor/blower.
- **Unique Hinged Face Access** – Easy to access HEPA filter allows for safer and quicker cleaning and filter replacement.
- **Aluminum Construction** – including face plate, cabinet, structural components, control box and inlet duct, making the FFU easier to transport, install and maintain.
- **High Efficiency Motor (ECM)** – For precise constant airflow and/or constant torque that is easy to adjust and balance in the field. Available in Forward curve or high efficiency backward curve plenum fan.
- **Static Pressure/Aerosol Sample Port** – Easily measure filter load status or aerosol concentration during PAO challenge.
- **Internal Fiber Free Insulation** – The insulation on the internal upper section of the unit functions as a sound absorber, mitigating the noise emitted by the unit while in operation.
- **Mounting Eyebolts** – Allows for easier and quicker mounting operation during install.

- **Powder Coated Appliance White, British White or Mill Finish** – For long lasting durability and improved aesthetics.
- **Full Range ECM Voltage Options** - The default ECM is available in 120, 208, 240, and 277V all UL listed.
- **MERV 8 pre-filter** – Standard for non-ducted applications, to increase the lifespan of the final HEPA filter, with option to upgrade to washable pre-filter.
- **Toggle Disconnect Switch** – for quick shutdown/power on of unit.

Optional Features

- **Aerosol Injection Port** – feature to test and commission the unit in the field and avoid leakages.
- **LED Loaded Filter Indicator (Red)** – Constant filter monitoring with warning LED light display when filter replacement is required.
- **LED Fan Operation Indicator (Green)** – Turns on during normal operation to give the user a visual on the unit performance.
- **Continuous Filter Monitoring** – Pressure transducer available to communicate on 0-10 VDC, Modbus or BACnet.
- **Ducted options** – 8", 10", 12", 14"
- **ULPA filter** – for applications requiring filtration with up to 99.9995% efficiency.

Key Features Diagram

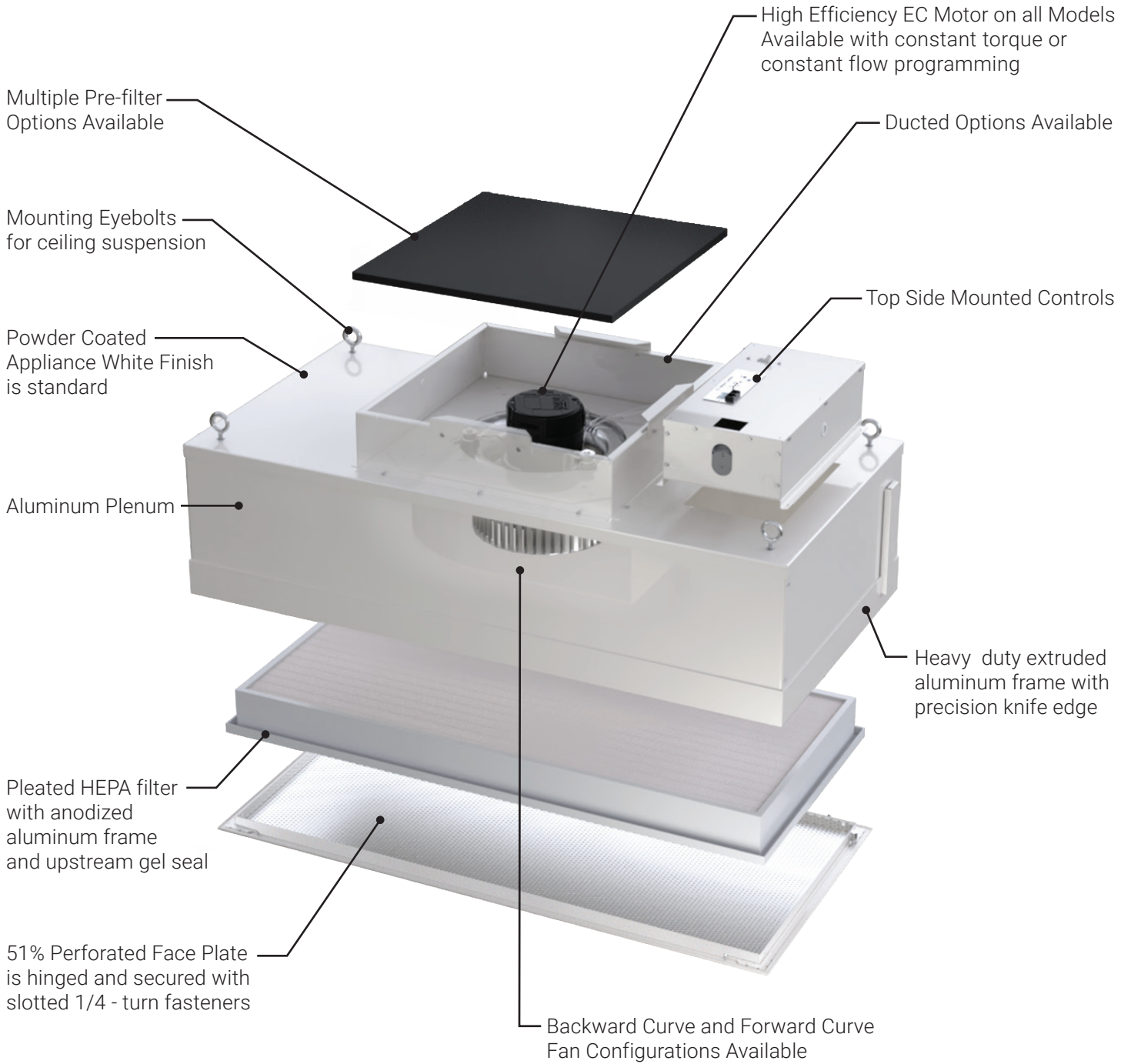

Motor and Blower Options

The new Nailor Fan Filter Units are available with the energy saving convenience of the EC Motor and offered with two fan options to comply with most requirements in the field. Available with a pressure independent forward curve fan or a high efficiency pressure dependent backward curve fan for maximum energy savings. Built to perform on the most stringent applications.

1. Forward Curve Fan

Our pressure independent forward curve fan offers low noise levels, high efficiency, stable performance and easy maintenance all while being a cost-effective option. Available with constant airflow and constant torque programming to maintain the air supply requirements even after filter loading starts increasing the pressure resistance after initial start up. It is a great option for non-ducted plenum applications.

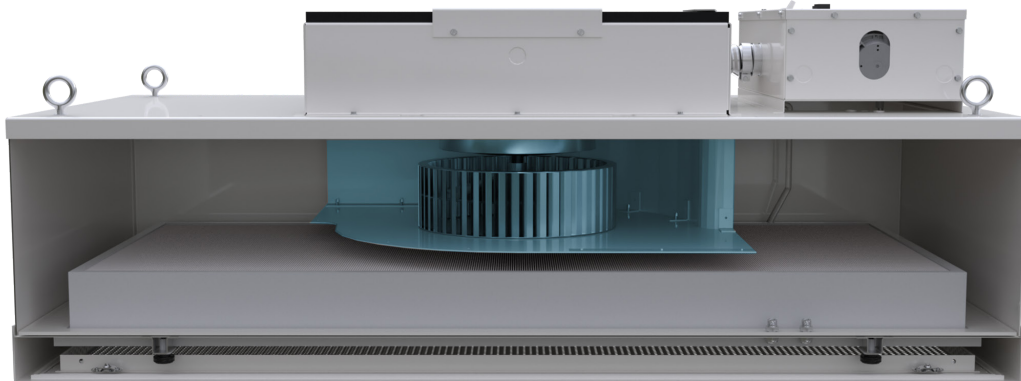
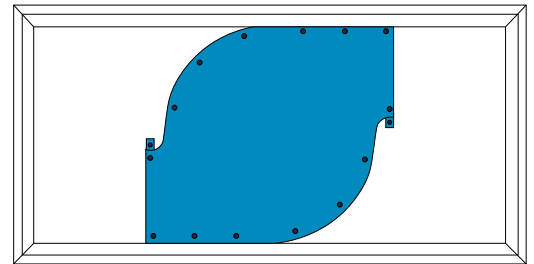

2. Backward Curve Fan

The pressure dependent backward curve fan excels on high efficiency, energy savings, high pressure variable speed operations and high durability. The factory programmed constant torque motor provides a great benefit for ducted applications, to be able to deliver the required airflow with variable inlet pressure.

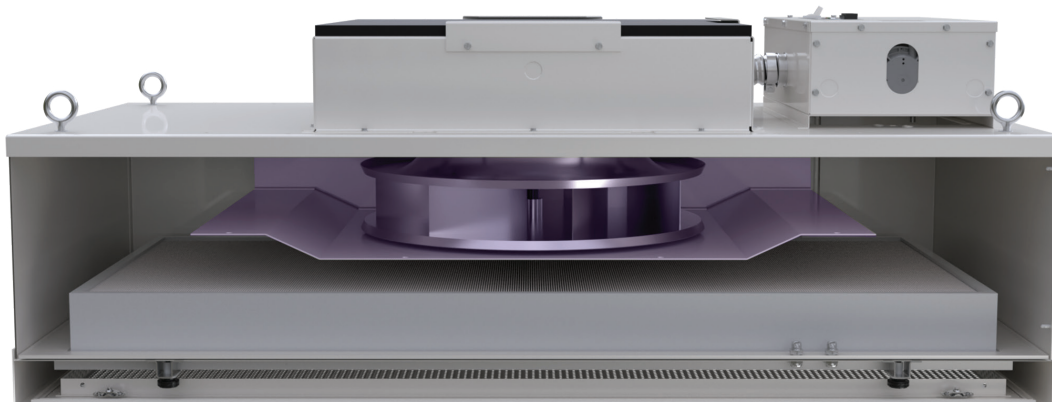
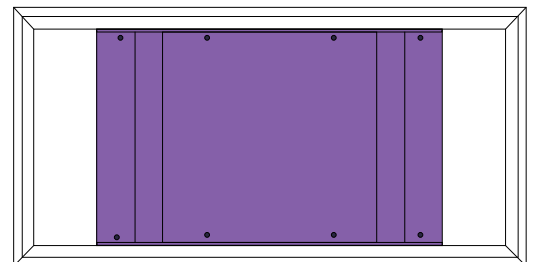

Ceiling View

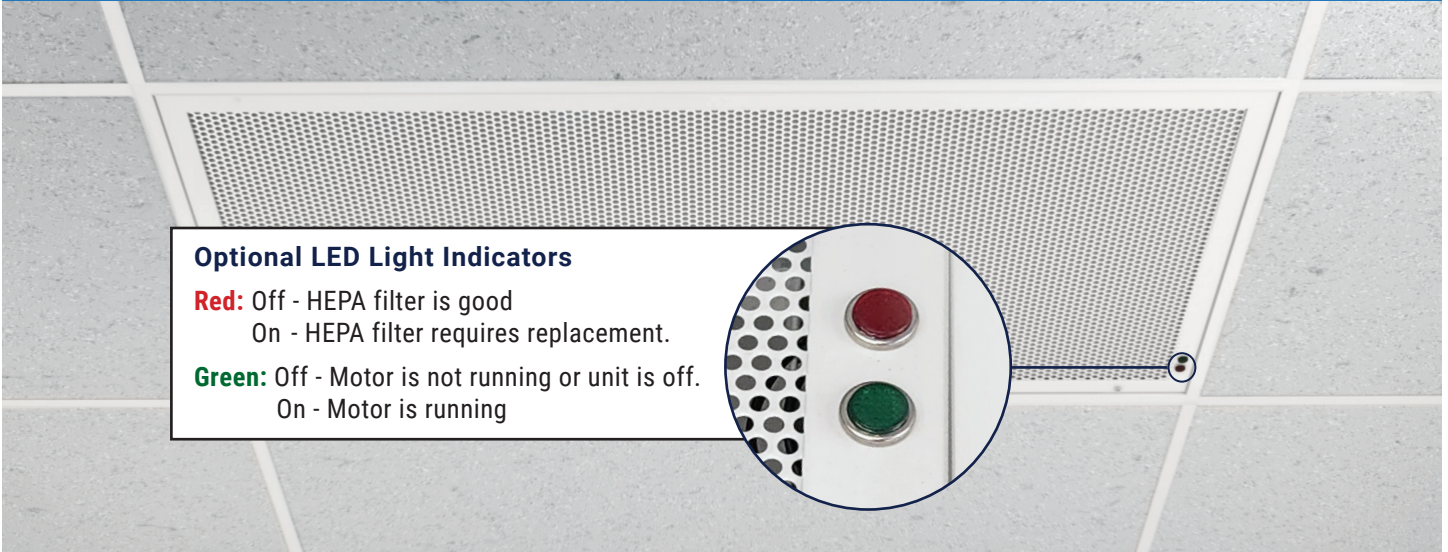

Optional LED Light Indicators

Red: Off - HEPA filter is good
 On - HEPA filter requires replacement.

Green: Off - Motor is not running or unit is off.
 On - Motor is running



Room-Side View

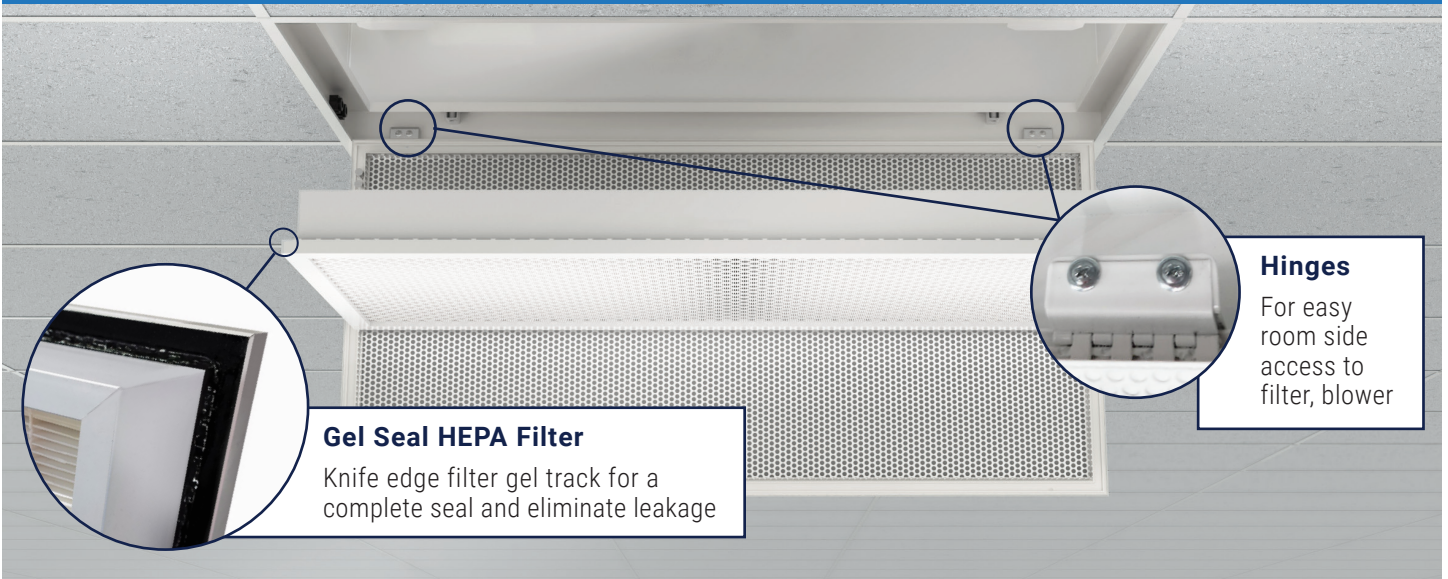

Gel Seal HEPA Filter

Knife edge filter gel track for a complete seal and eliminate leakage

Hinges

For easy room side access to filter, blower

Top-Side View

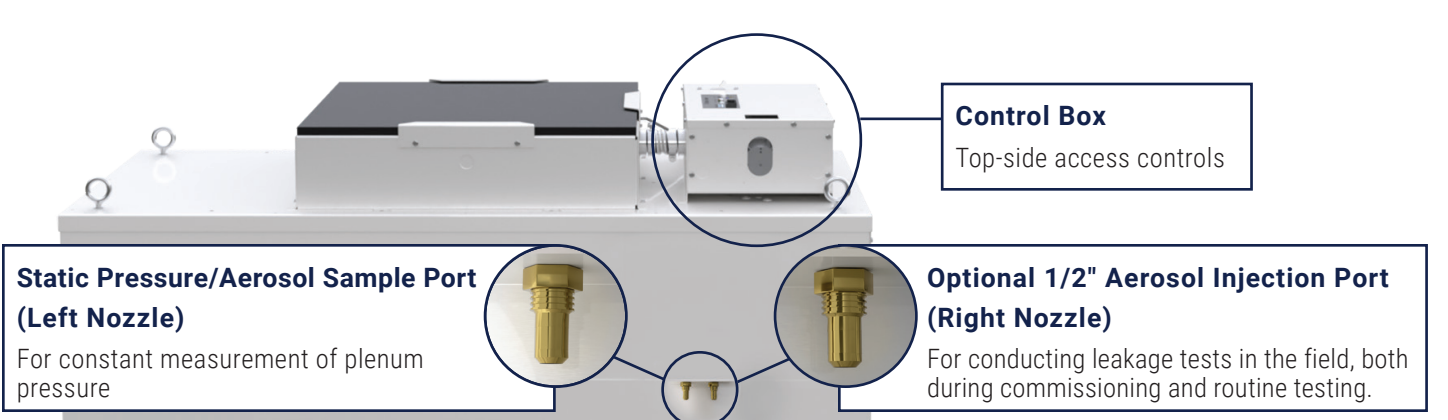

Control Box

Top-side access controls

Static Pressure/Aerosol Sample Port (Left Nozzle)

For constant measurement of plenum pressure



Optional 1/2" Aerosol Injection Port (Right Nozzle)

For conducting leakage tests in the field, both during commissioning and routine testing.



Specifications

- **Airflow capacity up to 794 CFM** for a more efficient distribution of clean air with less units.
- **All models available with EC Motors** for high energy efficiency and easy airflow control, offering standard factory programmed constant torque or constant flow programs to satisfy various application requirements.
- **Standard HEPA and ULPA filters available:**
 - HEPA filters are 99.99% efficient for matter of 0.3 micron diameter or larger.
 - ULPA filters are 99.9995% efficient for matter of 0.12 micron diameter or larger.
- **Pressure independent/dependent FC fan and pressure dependent BC fan** to maintain the required clean airflow in the space.
- Each filter is constructed per IEST-RP-CC001.5 standards and individually scan tested in accordance with IEST-RP-CC0034.3
- The new 92FFU unit is rated under the UL 507 standard.



Performance Data

ECM - Forward Curve Fan

Unit Size (in.)	Fan	Active Filter Area (sq. ft)	Min CFM	Max CFM	Watts @ Max CFM	Watts per CFM @ Max CFM	CFM @ 90 FPM	Watts @ 90 FPM	Watts per CFM @90 FPM	Sound dBA at 90 FPM	
W/O Pre-Filter, Internal Potentiometer											
48 x 24	FC	5.34	214*	785	264	0.34	480	96	0.20	55	
Aluminum washable Pre-Filter, Internal Potentiometer											
48 x 24	FC	5.34	—	790	279	0.35	480	98	0.20		
MERV 8 Pre-Filter, Internal Potentiometer											
48 x 24	FC	5.34	—	794	369	0.46	480	111	0.23		

* Non-ducted inlet, no pre-filter, manual mode, constant airflow program

ECM - Backward Curve Fan

Unit Size (in.)	Fan	Active Filter Area (sq. ft)	Min CFM	Max CFM	Watts @ Max CFM	Watts per CFM @ Max CFM	CFM @ 90 FPM	Watts @ 90 FPM	Watts per CFM @90 FPM	Sound dBA at 90 FPM	
W/O Pre-Filter, Internal Potentiometer											
48 x 24	BC	5.34	175*	752	138	0.18	480	67	0.14	52	
Aluminum washable Pre-Filter, Internal Potentiometer											
48 x 24	BC	5.34	—	734	139	0.19	480	69	0.14		
MERV 8 Pre-Filter, Internal Potentiometer											
48 x 24	BC	5.34	—	638	138	0.22	480	87	0.18		

* Non-ducted inlet, no pre-filter, manual mode, constant torque program

Electrical Data

Forward Curve Fan

Model	Unit Size	Voltage	Phase	HZ	Motor HP	Motor FLA
92FFU-FC	2 x 4	120	1	60	1/3	4.17
		208	1	60	1/3	2.79
		240	1	60	1/3	2.68
		277	1	60	1/3	2.61

Backward Curve Fan

Model	Unit Size	Voltage	Phase	HZ	Motor HP	Motor FLA
92FFU-BC	2 x 4	120	1	60	1/3	1.82
		208	1	60	1/3	1.17
		240	1	60	1/3	1.12
		277	1	60	1/3	1.09

Fan Curve • Forward Curve Constant Airflow Program

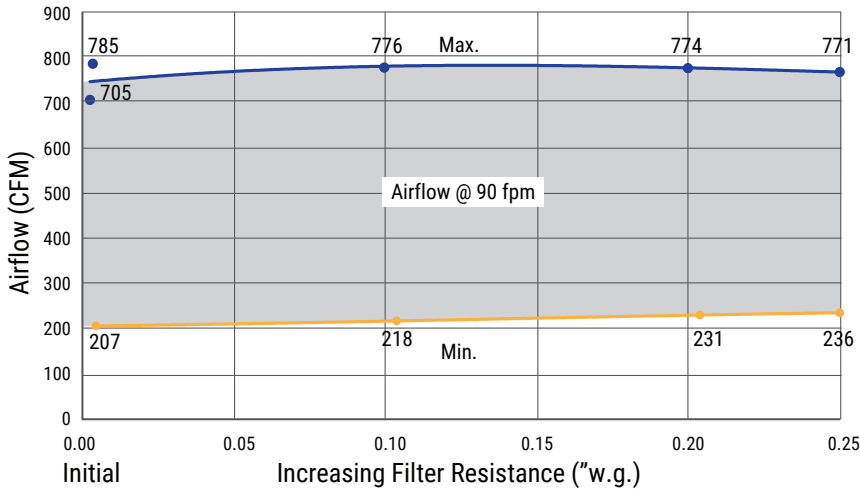

Notes:

- This ECM fan curve illustrates pressure independent and constant volume operation as the HEPA filter loads with time and static pressure increases.
- The ECM compensates as the HEPA filter resistance increases.
- Airflow can be set to operate on horizontal performance line at any point within shaded area.
- Initial HEPA filter resistance is included (typically 0.5\"w.g. at 90fpm)

FC Constant Torque Motor Program

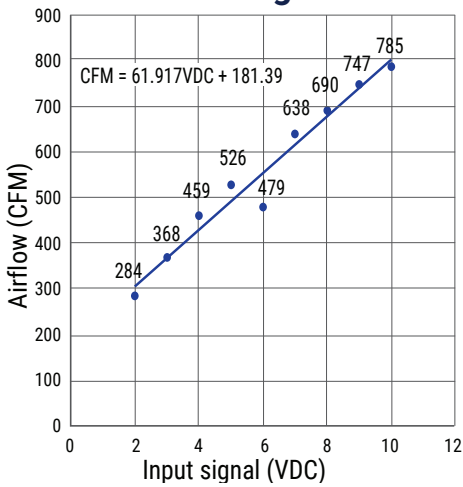

FC Constant Airflow Motor Program

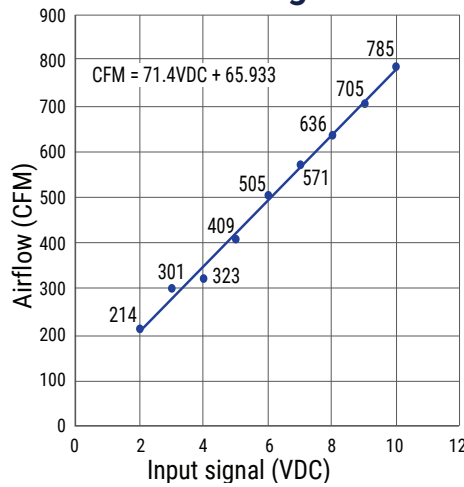

BC Constant Torque Motor Program

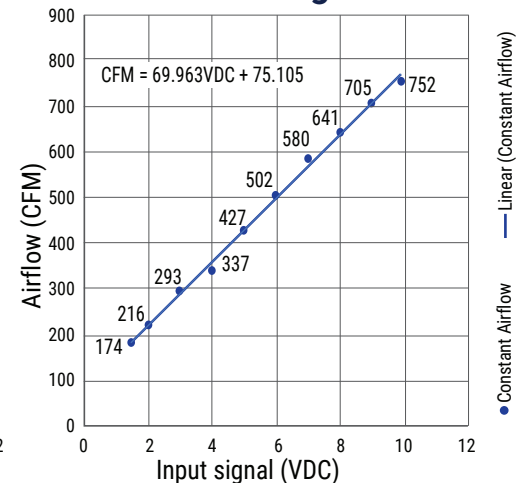

Non-Ducted Unit Dimensional Data

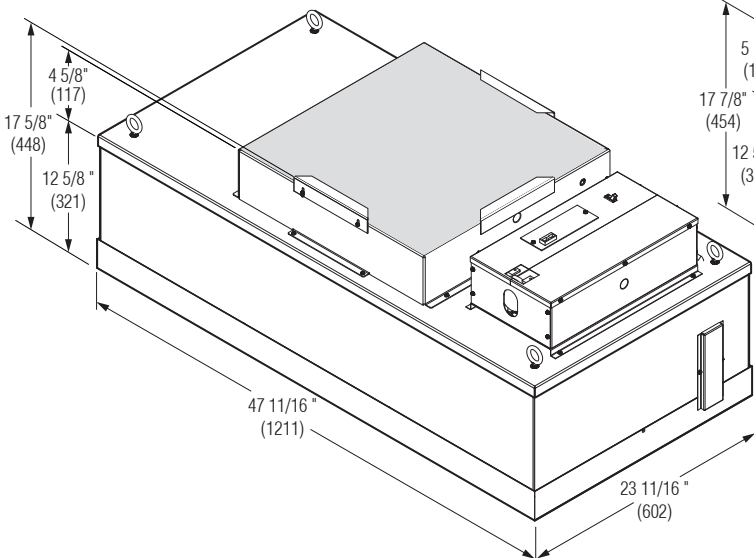

Ducted Unit Dimensional Data

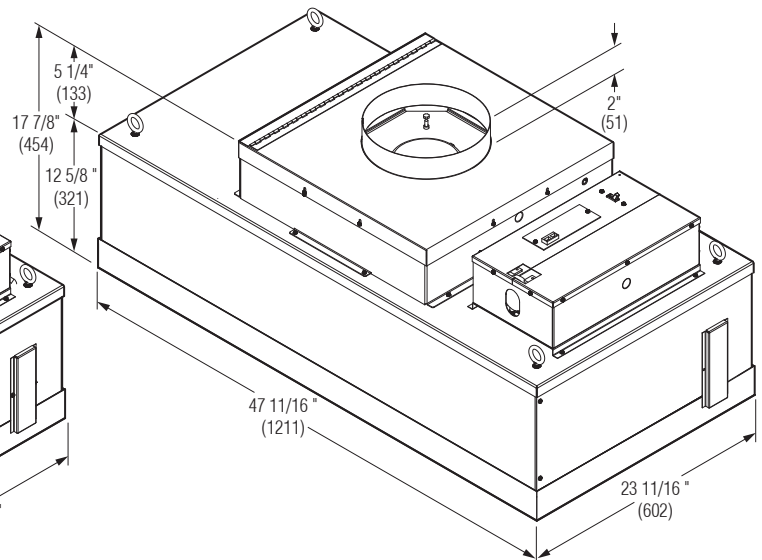

Controls

Fan filter units (FFUs) are commonly used in various applications where precision is a must, and airflow controls are the main players. Potentiometers, wall-mounted controls, and BACnet controls can enhance the functionality and efficiency of FFUs equipped with electronically commutated motors (ECM). Here are the benefits of using these components in combination:

1. Potentiometer Control

Variable Speed Control: The standard FFU low-voltage controller includes a potentiometer that allows the user to locally adjust the speed of the ECM motor manually.

- Multi-meter outputs for Vdc set point and RPM feedback
- Field ready for Modbus networking (up to 247 units)
- Two RJ45 jacks provided for standard CAT5 cable daisy chain connections

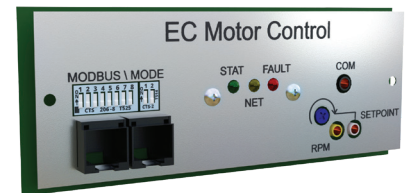

2. Wall-Mounted Controls

Convenience: Wall-mounted controls provide a centralized and easily accessible way to manage the FFU within a room or facility. Easy to wire and adjust the airflow to a single or a group of FFUs connected to the controller without the need to get to each unit.

Contact your local Nailor Representative for more information.



3. Modbus and BACnet Controls

Integration: BACnet and Modbus are two different protocols used in building automation and control systems. Integrating FFUs with BACnet or Modbus controls allows seamless communication and coordination with other building systems, such as HVAC, lighting, and security. This integration ensures that all systems work together harmoniously, leading to optimized energy usage and overall building efficiency. Our FFUs are Modbus native with the option to convert to BACnet IP or MS/TP protocol with the use of the optional gateway, amplifying the capability to daisy chain up to 30, 60 and 100 units to connect them to the BMS system.

BACnet or Modbus-enabled FFUs can provide valuable data and analytics, such as energy consumption patterns and performance trends. Analyzing this data can lead to insights that help in optimizing the operation of FFUs, prolonging equipment life, and reducing energy costs.

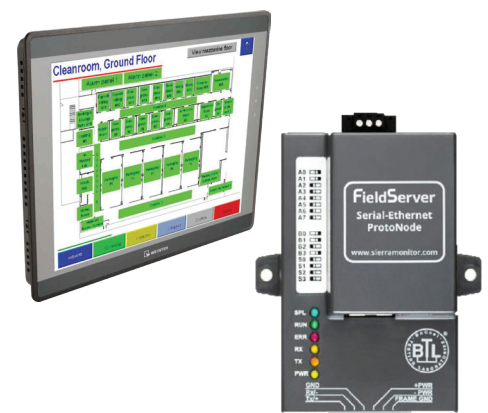

By combining potentiometer control for local adjustments, wall-mounted controls for easy, accessible centralized management, and Modbus or BACnet controls for seamless integration and data analysis, FFUs with ECM motors can operate at their maximum efficiency, leading to energy savings, improved air quality, and extended equipment lifespan.



About Nailor

Nailor Industries, Inc. is known for our industry leading customer focused approach to providing innovative commercial and industrial HVAC products. Nailor manufactures a unique and comprehensive line of products essential for a well designed HVAC system. Product offerings include Air Control & Distribution products, VAV Terminal Units, Green Building products, Fan Coil Units, Electric Duct Heaters, Sound Attenuators, Air Handling Units, and Filter Housings. Coupled with a wide range of product offerings and industry leading design, testing and manufacturing capabilities, Nailor offers a single source solution for all of your HVAC needs.



nailor.com

