



**FAN POWERED CHILLED WATER TERMINAL UNIT**  
**SENSIBLE COOLING (DOAS)**  
**CONSTANT OR VARIABLE VOLUME**  
**MODELS: 33SZ, 33SZE AND 33SZW**  
**UNIT SIZES: 10 AND 30 (LOW PROFILE)**

**DESCRIPTION:**

- Sensible cooling coil on the induced air inlet handles zone sensible load. Opposite side to controls location. Aluminum ripple fins (10 FPI) and 1/2" (13) copper tubes. Hand of coil connection is determined looking in direction of airflow (RH shown).
- 20 ga. (1.00) galvanized steel construction.
- 16 ga. (1.61) galvanized steel inclined opposed blade damper. 45° rotation. CW to close.
- Ultra-high efficiency ECM fan motor. EPIC fan volume controller.
- 1/2" (13) dual density fiberglass installation, exposed edge coated to prevent air erosion. Meets requirements of NFPA 90A and UL 181.
- Access panels top and bottom.
- Multi-point averaging Diamond Flow Sensor. Supplied with balancing tees.
- Discharge opening designed for flanged duct connection.
- Single point electrical connection.
- Low voltage NEMA 1 type enclosure for factory mounted DDC controls.
- Controls mounted as standard on RH side as shown. Unit size 30 ordered with LH controls (optional) is inverted and discharge duct hanging elevation will therefore change.
- Galvanized steel drip pan integral to sensible coil.

**OPTIONS:**

**CW Coil:**

- 2-Row  4-Row
- 6-Row  8-Row
- Condensate Sensor

**Coil Connections:**

- Right Hand (Default)
- Left Hand

**Liner:**

- Fiber-free
- Steri-liner
- Steri-liner + Perforated metal
- Perforated metal
- Solid metal

**Filter:**

- 1" (25) Throwaway
- 2" (51) Pleated MERV 8
- 2" (51) Pleated MERV 13
- Ducted Return Filter Rack (See submittal 33SZ-FR)

**Model 33SZ • Basic Unit**

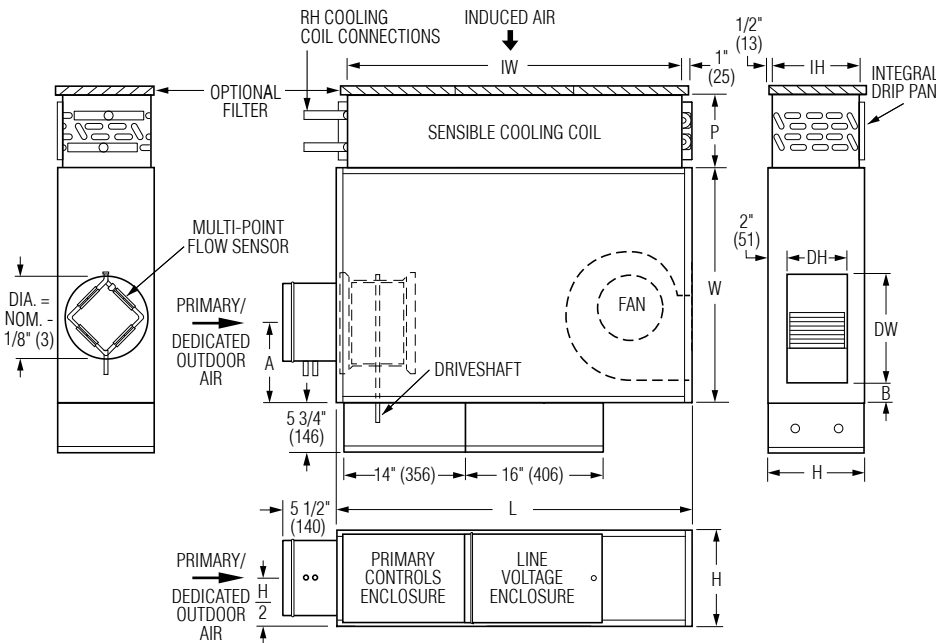

**Dimensional Data**

Unit Size	Inlet Size	W	H	L	A	B	Cooling Coil IW x IH	P	Outlet Discharge DW x DH	Filter Size
10	4, 5, 6 (102, 127, 152)	26 1/2 (673)	8 1/2 (216)	47 1/4 (1200)	5 1/8 (130)	2 (51)	43 x 7 1/2 (1092 x 191)	2 Row: 5 1/8 (130)	7 1/8 x 4 3/4 (181 x 121)	45 x 8 1/2 (1143 x 216)
								4 Row: 7 5/16 (186)		
								6 Row: 9 1/2 (241)		
30	4, 5, 6, 8 (102, 127, 152, 203)	26 1/2 (673)	11 (279)	40 1/4 (1022)	8 (203)	2 (51)	36 x 8 3/4 (914 x 222)	8 Row: 11 11/16 (297)	12 3/8 x 6 7/8 (314 x 175)	38 x 10 (965 x 254)

**Electrical Data**

Unit Size	EPIC ECM Motor FLA				
	Motor HP	120V	208V	240V	277V
10	*	2.2	1.6	1.5	1.5
30	*	7.5	5.0	5.0	4.9

**CW Coil O.D. Sweat Connections**

Unit Size	No. of Row
10, 30	2, 4, 6 & 8
	7/8" (22)

\* The EPIC ECM is a variable horsepower motor. Refer to Selectworks schedule for actual power consumption. FLA = Full load amperage. All motors are single phase/60 Hz.

**Electrical:**

- LH Controls enclosure
- Toggle disconnect switch
- FN3 – Remote line voltage enclosure
- Motor fusing

**Other:**

- Cross Flow Sensor
- Hanger brackets
- 1/4-turn fasteners (access panel)
- Induced Air Silencer (See submittal 33SZ-DSI)
- Induced Air Silencer Elbow (See submittal 33SZ-DSIE)



- Seismic Certification (Size 30):**
- Seismic Source International (Standard)
  - HCAI (formerly OSHPD, California)
  - Special features: \_\_\_\_\_

For heat options; see page 2.  
 Dimensions are in inches (mm).

<b>SCHEDULE TYPE:</b>				
<b>PROJECT:</b>				
<b>ENGINEER:</b>	<b>DATE</b>	<b>B SERIES</b>	<b>SUPERSEDES</b>	<b>DRAWING NO.</b>
<b>CONTRACTOR:</b>	2 - 6 - 23	3300	7 - 20 - 21	33SZ-1



**FAN POWERED CHILLED WATER TERMINAL UNIT**  
**SENSIBLE COOLING (DOAS)**  
**CONSTANT OR VARIABLE VOLUME**  
**MODELS: 33SIZE AND 33SZW**  
**UNIT SIZES: 10 AND 30 (LOW PROFILE)**

**Hot Water Coil Section**  
**Model 33SZW**

**Standard Features:**

- Coil section installed on unit discharge.
- Coil (and header on multi-circuit units) is installed in insulated casing for increased thermal efficiency.
- 1/2" (13) copper tubes.
- Aluminum ripple fins (10 FPI).
- Sweat Connections: One row: 1/2" (13) O.D. male solder. Two row: 5/8" (16) O.D. male solder.
- Flanged outlet duct connection.

**Coil Rows:**

- 1-Row     2-Row

**Coil Hand Connections:**

(Looking in direction of airflow)

- Right Hand (illustrated). Standard.  
 Left Hand. Optional.

Heating coil, sensible coil and controls enclosure orientation must all be specified separately.

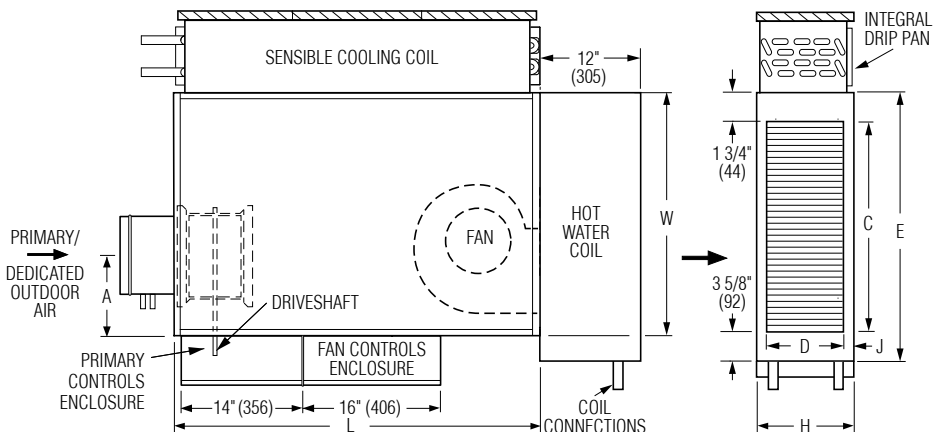

**Dimensional Data**

Unit Size	W	H	L	Outlet Duct Size C x D	J	E
10	26 1/2 (673)	8 1/2 (216)	47 1/4 (1200)	24 x 7 1/2 (610 x 191)	1/2 (13)	29 3/8 (746)
30	26 1/2 (673)	11 (279)	40 1/4 (1022)	24 x 8 3/4 (610 x 222)	1 1/8 (29)	29 3/8 (746)

**Electric Coil Section**  
**Model 33SE**

**Standard Features:**

- Unique hinged heater design permits easy access, removal and replacement of heater element without disturbing ductwork.
- Coil installed on unit discharge.
- Insulated coil element wrapper.
- Automatic reset high limit cut-outs (one per element).
- Single point electrical connection for entire terminal unit.
- Magnetic contactors per stage.
- Class A 80/20 Ni/Cr wire.
- Electronic Fan Interlock Relay.
- Flanged outlet duct connection.
- Terminal unit with coil is ETL listed as on assembly.
- Controls mounted as standard on RH side as shown. Terminals ordered with L.H. controls (optional) are inverted.

**Voltage:**

- Single phase, 60 Hz.  
 120V     208V  
 240V     277V  
 Three phase, 60 Hz.  
 208V     480V (4 wire wye)  
 600V (dual point connection)  
 \_\_\_\_\_

**Electric Coil Options:**

- SCR control  
 SCR control with discharge temperature control  
 Toggle disconnect (includes fan)  
 Door interlock disconnect switch  
 Quiet contactors  
 Main line fusing  
 Dust tight construction  
 Manual Reset secondary thermal cut out  
 Positive Pressure airflow switch

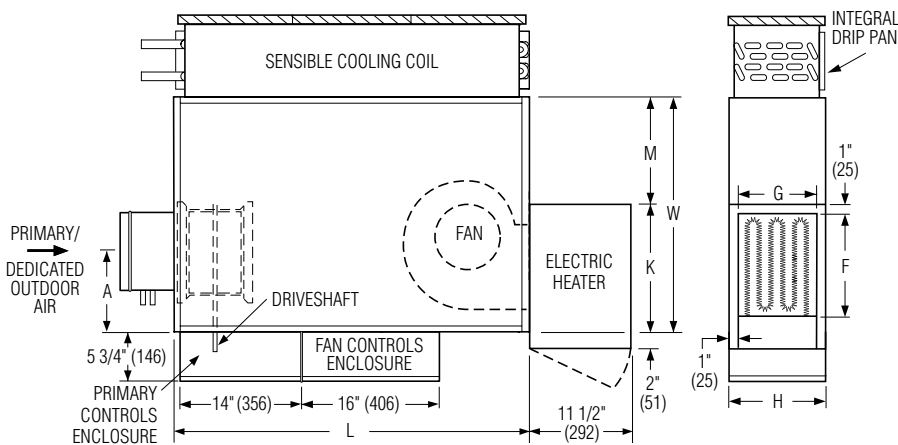

**Dimensional Data**

Unit Size	W	H	L	K	M	Outlet Duct Size F x G
10	26 1/2 (673)	8 1/2 (213)	47 1/4 (1200)	11 1/4 (286)	15 1/4 (387)	8 1/4 x 6 (210 x 152)
30	26 1/2 (673)	11 (279)	40 1/4 (1022)	15 3/8 (391)	11 1/8 (283)	12 3/8 x 9 (314 x 229)

**SCHEDULE TYPE:**

**PROJECT:**

**ENGINEER:**

**CONTRACTOR:**

Page 2 of 3.  
 Dimensions are in inches (mm).

DATE	B SERIES	SUPERSEDES	DRAWING NO
2 - 6 - 23	3300	7 - 20 - 21	33SZ-1



**FAN POWERED CHILLED WATER TERMINAL UNITS  
ORIENTATIONS  
MODELS: 33SZE AND 33SZW  
UNIT SIZES: 10 AND 30 (LOW PROFILE)**

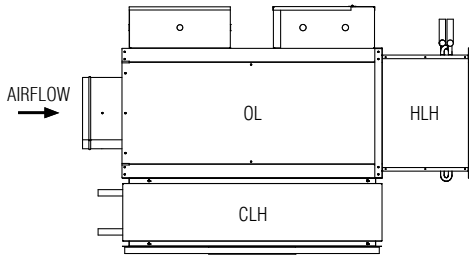

**OL** LEFT HAND CONTROLS  
**CLH** LEFT HAND COOLING COIL CONNECTIONS  
**HLH** LEFT HAND HEATING COIL CONNECTIONS

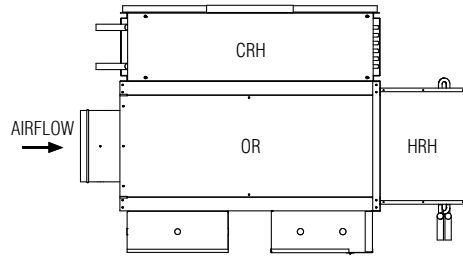

**OR** RIGHT HAND CONTROLS  
**CRH** RIGHT HAND COOLING COIL CONNECTIONS  
**HRH** RIGHT HAND HEATING COIL CONNECTIONS

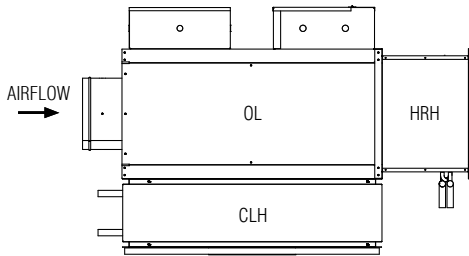

**OL** LEFT HAND CONTROLS  
**CLH** LEFT HAND COOLING COIL CONNECTIONS  
**HRH** RIGHT HAND HEATING COIL CONNECTIONS

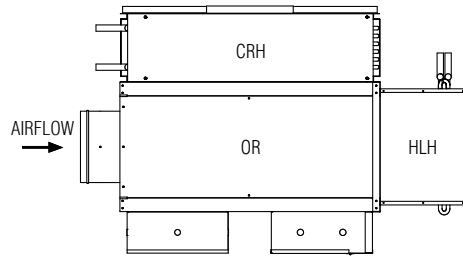

**OR** RIGHT HAND CONTROLS  
**CRH** RIGHT HAND COOLING COIL CONNECTIONS  
**HLH** LEFT HAND HEATING COIL CONNECTIONS

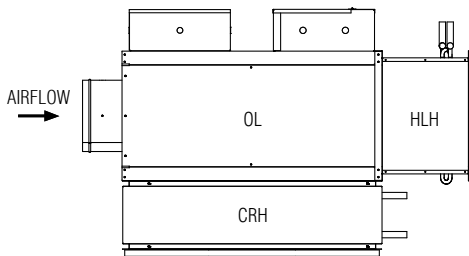

**OL** LEFT HAND CONTROLS  
**CRH** RIGHT HAND COOLING COIL CONNECTIONS  
**HLH** LEFT HAND HEATING COIL CONNECTIONS

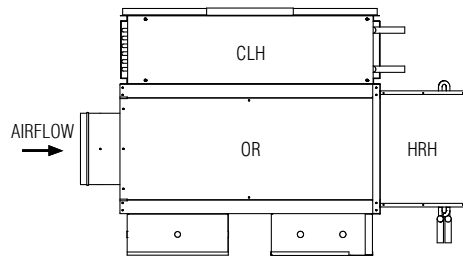

**OR** RIGHT HAND CONTROLS  
**CLH** LEFT HAND COOLING COIL CONNECTIONS  
**HRH** RIGHT HAND HEATING COIL CONNECTIONS

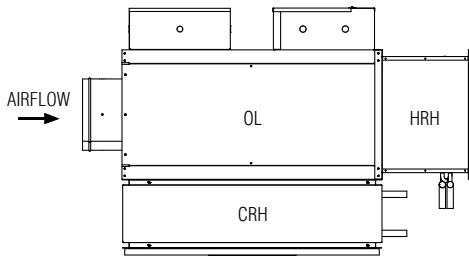

**OL** LEFT HAND CONTROLS  
**CRH** RIGHT HAND COOLING COIL CONNECTIONS  
**HRH** RIGHT HAND HEATING COIL CONNECTIONS

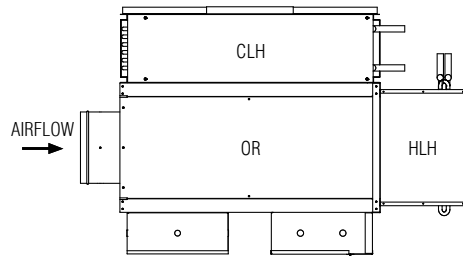

**OR** RIGHT HAND CONTROLS  
**CLH** LEFT HAND COOLING COIL CONNECTIONS  
**HLH** LEFT HAND HEATING COIL CONNECTIONS

**SCHEDULE TYPE:**

**PROJECT:**

**ENGINEER:**

**CONTRACTOR:**

Page 3 of 3.

Dimensions are in inches (mm)

**DATE**

**B SERIES**

**SUPERSEDES**

**DRAWING NO.**

2 - 6 - 23

3300

7 - 20 - 21

33SZ-1



**FAN POWERED CHILLED WATER TERMINAL UNIT**  
**SENSIBLE COOLING (DOAS)**  
**CONSTANT OR VARIABLE VOLUME**  
**MODELS: 33SZ, 33SE AND 33SZW**  
**UNIT SIZE 35 (LOW PROFILE)**

**DESCRIPTION:**

- Sensible cooling coil on the induced air inlet handles zone sensible load. Opposite side to controls location. Aluminum ripple fins (10 FPI) and 1/2" (13) copper tubes. Hand of coil connection is determined looking in direction of airflow (RH shown).
- 20 ga. (1.00) galvanized steel construction.
- 16 ga. (1.61) galvanized steel inclined opposed blade damper. 45° rotation. CW to close.
- Ultra-high efficiency ECM fan motor. EPIC fan volume controller.
- 1/2" (13) dual density fiberglass installation, exposed edge coated to prevent air erosion. Meets requirements of NFPA 90A and UL 181.
- Access panels top and bottom.
- Multi-point averaging Diamond Flow Sensor. Supplied with balancing tees.
- Discharge opening designed for flanged duct connection.
- Single point electrical connection.
- Low voltage NEMA 1 type enclosure for factory mounted DDC controls.
- Controls mounted as standard on RH side as shown. Unit size 35 ordered with LH controls (optional) is inverted.
- Galvanized steel drip pan integral to sensible coil.

**OPTIONS:**

- CW Coil:**
- 2-Row  4-Row
  - 6-Row  8-Row
  - Condensate Sensor
- Coil Connections:**
- Right Hand (Default)
  - Left Hand
- Liner:**
- Fiber-free
  - Steri-liner
  - Steri-liner + Perforated metal
  - Perforated metal
  - Solid metal
- Filter:**
- 1" (25) Throwaway.
  - 2" (51) Pleated MERV 8.
  - 2" (51) Pleated MERV 13.
  - Ducted Return Filter Rack (See submittal 33SZ-FR).

**Model 33SZ • Basic Unit**

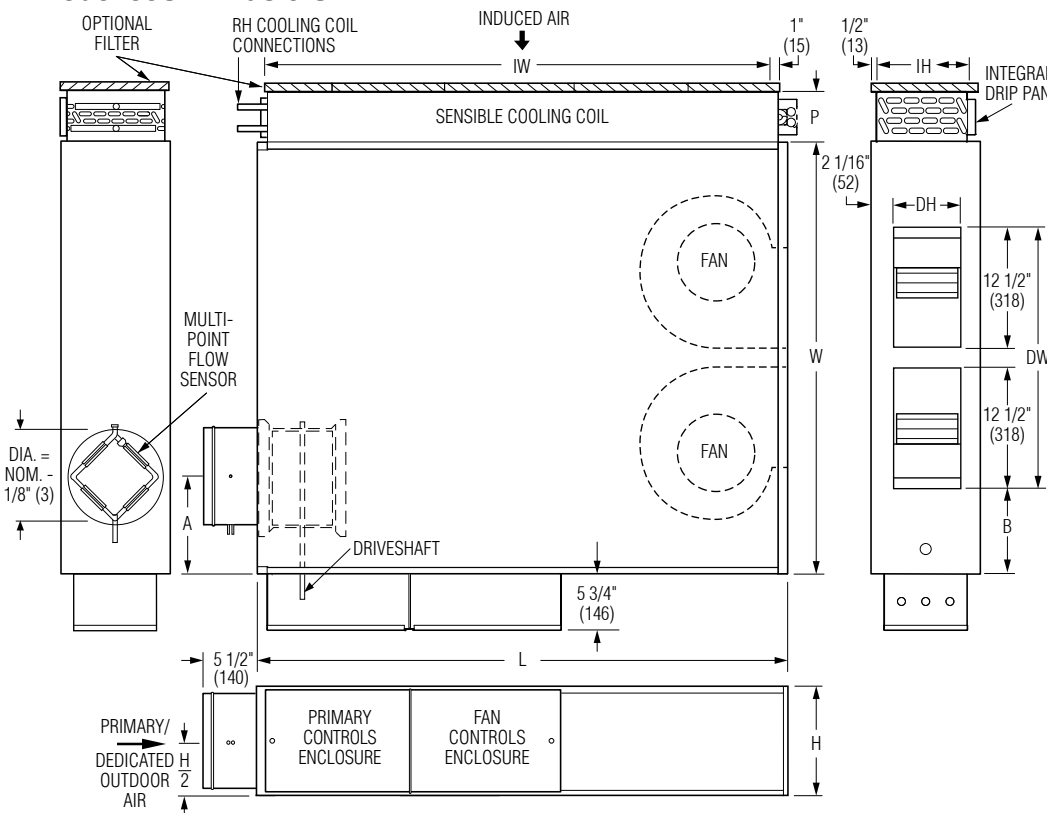

**Dimensional Data**

Unit Size	Inlet Size	W	H	L	A	B	Cooling Coil IW x IH	P	Outlet Discharge DW x DH	Filter Size
35	4, 5, 6, 8, 10 (102, 127, 152, 203, 254)	44 (1118)	11 (279)	54 (1372)	8 (203)	8 1/2 (216)	50 x 10 (1270 x 254)	2 Row: 5 1/8 (130) 4 Row: 7 5/16 (186) 6 Row: 9 1/2 (241) 8 ROW: 11 1/2 (292)	27 x 6 7/8 (686 x 175)	2@ 26 x 11 (660 x 279)

**Electrical Data**

Unit Size	EPIC ECM Motor FLA				
	Motor HP	120V	208V	240V	277V
35	*	9.4	6.3	6.1	5.8

**CW Coil O.D. Sweat Connections**

Unit Size	No. of Row
35	2, 4, 6 & 8
35	7/8" (22)

\* The EPIC ECM is a variable horsepower motor. Refer to Selectworks schedule for actual power consumption. FLA = Full load amperage. All motors are single phase/60 Hz.

- Electrical:**
- LH Controls enclosure
  - Toggle disconnect switch.
  - FN3 – Remote line voltage enclosure.
  - Motor fusing.
- Other:**
- Cross Flow Sensor
  - Hanger brackets
  - 1/4-turn Fasteners (access panel)
  - Induced Air Silencer (See submittal 33SZ-DSI)
  - Induced Air Silencer Elbow (See submittal 33SZ-DSIE)

- Seismic Certification:**
- Seismic Source International (Standard)
  - HCAI (formerly OSHPD, California)
  - Special Features:



**SCHEDULE TYPE:**

**PROJECT:**

**ENGINEER:**

**CONTRACTOR:**

Page 1 of 3; For heat options; see page 2.  
 Dimensions are in inches (mm).

DATE	B SERIES	SUPERSEDES	DRAWING NO.
11 - 6 - 23	3300	8 - 3 - 23	33SZ-1A



**FAN POWERED CHILLED WATER TERMINAL UNIT**  
**SENSIBLE COOLING (DOAS)**  
**CONSTANT OR VARIABLE VOLUME**  
**MODELS: 33SIZE AND 33SZW**  
**UNIT SIZE 35 (LOW PROFILE)**

**Hot Water Coil Section**  
**Model 33SZW**

**Standard Features:**

- Coil section installed on unit discharge.
- Coil (and header on multi-circuit units) is installed in insulated casing for increased thermal efficiency.
- 1/2" (13) copper tubes.
- Aluminum ripple fins (10 FPI).
- Sweat Connections: One row: 1/2" (13) O.D. male solder. Two row: 5/8" (16) O.D. male solder.
- Flanged outlet duct connection.

**Coil Rows:**

- 1-Row     2-Row

**Coil Hand Connections:**

- (Looking in direction of airflow).
- Right Hand (illustrated). Standard.
  - Left Hand. Optional.

Heating coil, sensible coil and controls enclosure orientation must all be specified separately.

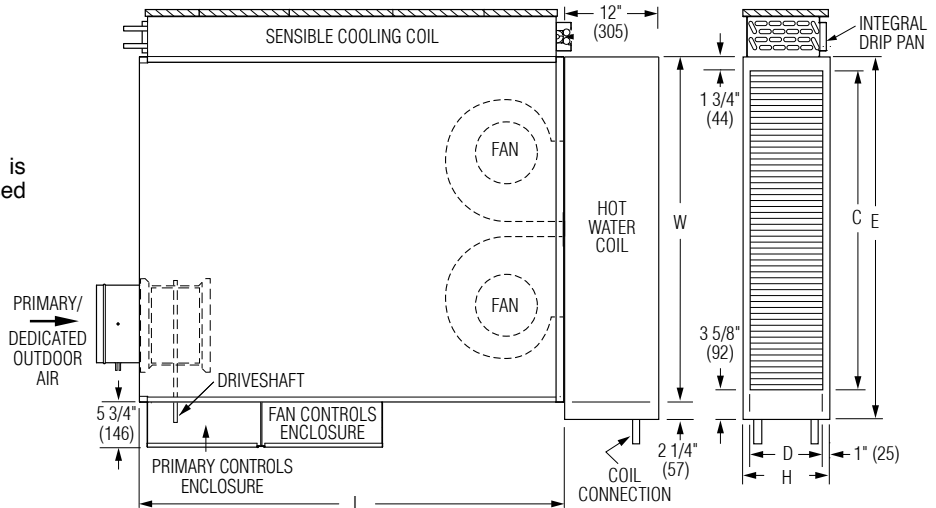

**Dimensional Data**

Unit Size	W	H	L	E	Outlet Duct Size C x D
35	44 (1118)	11 (279)	54 (1372)	46 3/8 (1178)	41 x 9 (1041 x 229)

**Electric Coil Section**  
**Model 33SIZE**

**Standard Features:**

- Controls enclosure incorporates a hinged access door opening upstream that helps ensure NEC clearance requirements and reduces footprint. (FN2 90° design is standard).
- Unique hinged heater design permits easy access, removal and replacement of heater element without disturbing ductwork.
- Coil installed on unit discharge.
- Insulated coil element wrapper.
- Automatic reset high limit cut-outs (one per element).
- Single point electrical connection for entire terminal unit.
- Magnetic contactors per stage.
- Class A 80/20 Ni/Cr wire.
- Electronic Fan Interlock Relay.
- Flanged outlet duct connection.
- Terminal unit with coil is ETL listed as on assembly.
- Controls mounted as standard on RH side as shown. Terminals ordered with L.H. controls (optional) are inverted.

**Voltage:**

Single phase, 60 Hz.

- 120V     208V  
 240V     277V

Three phase, 60 Hz.

- 208V     480V (4 wire wye).  
 600V (dual point connection).  
 \_\_\_\_\_

**Electric Coil Options:**

- SCR control.
- SCR control with discharge temperature control.
- Toggle disconnect (includes fan).
- Door interlock disconnect switch.
- Quiet contactors.
- Main line fusing.
- Dust tight construction.
- Manual Reset secondary thermal cut out.
- Positive Pressure airflow switch.

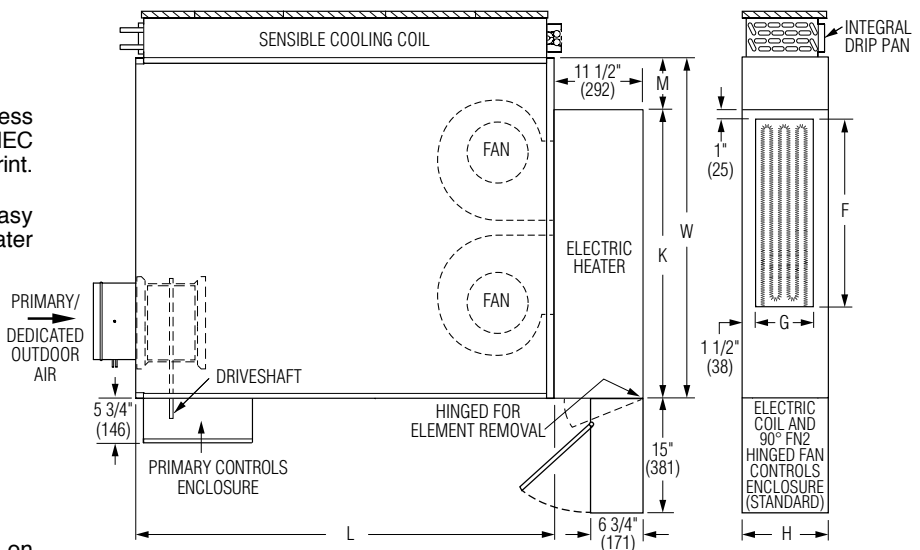

**Dimensional Data**

Unit Size	W	H	L	K	M	Outlet Duct Size F x G
35	44 (1118)	11 (279)	54 (1372)	37 3/8 (949)	6 5/8 (168)	25 x 8 (635 x 203)

**SCHEDULE TYPE:**

**PROJECT:**

**ENGINEER:**

**CONTRACTOR:**

Page 2 of 3.  
 Dimensions are in inches (mm).

DATE	B SERIES	SUPERSEDES	DRAWING NO
11 - 6 - 23	3300	8 - 3 - 23	33SZ-1A



**FAN POWERED CHILLED WATER TERMINAL UNITS  
ORIENTATIONS  
MODELS: 33SZE AND 33SZW  
UNIT SIZE 35 (LOW PROFILE)**

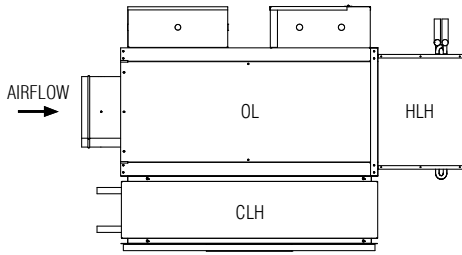

**OL** LEFT HAND CONTROLS  
**CLH** LEFT HAND COOLING COIL CONNECTIONS  
**HLH** LEFT HAND HEATING COIL CONNECTIONS

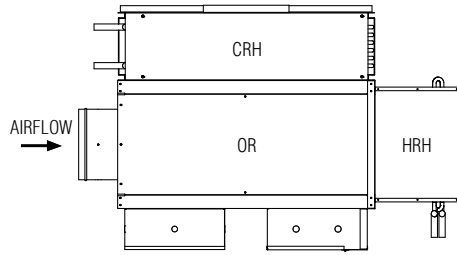

**OR** RIGHT HAND CONTROLS  
**CRH** RIGHT HAND COOLING COIL CONNECTIONS  
**HRH** RIGHT HAND HEATING COIL CONNECTIONS

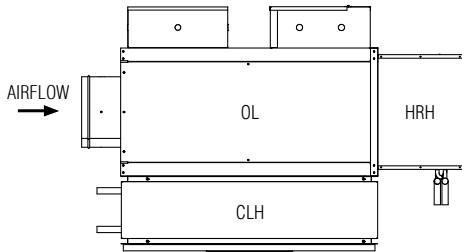

**OL** LEFT HAND CONTROLS  
**CLH** LEFT HAND COOLING COIL CONNECTIONS  
**HRH** RIGHT HAND HEATING COIL CONNECTIONS

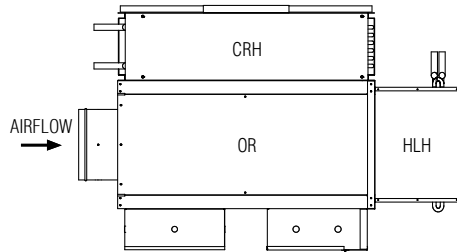

**OR** RIGHT HAND CONTROLS  
**CRH** RIGHT HAND COOLING COIL CONNECTIONS  
**HLH** LEFT HAND HEATING COIL CONNECTIONS

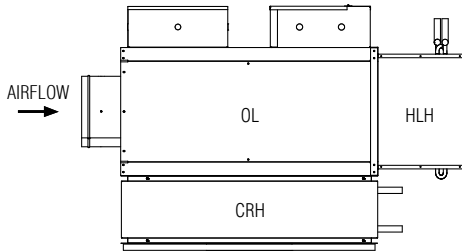

**OL** LEFT HAND CONTROLS  
**CRH** RIGHT HAND COOLING COIL CONNECTIONS  
**HLH** LEFT HAND HEATING COIL CONNECTIONS

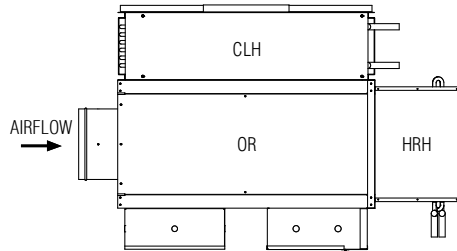

**OR** RIGHT HAND CONTROLS  
**CLH** LEFT HAND COOLING COIL CONNECTIONS  
**HRH** RIGHT HAND HEATING COIL CONNECTIONS

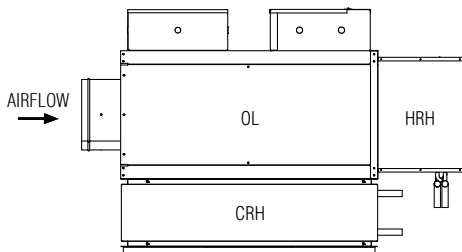

**OL** LEFT HAND CONTROLS  
**CRH** RIGHT HAND COOLING COIL CONNECTIONS  
**HRH** RIGHT HAND HEATING COIL CONNECTIONS

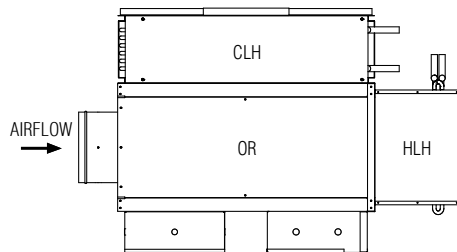

**OR** RIGHT HAND CONTROLS  
**CLH** LEFT HAND COOLING COIL CONNECTIONS  
**HLH** LEFT HAND HEATING COIL CONNECTIONS

**SCHEDULE TYPE:**

**PROJECT:**

**ENGINEER:**

**CONTRACTOR:**

Page 3 of 3.

Dimensions are in inches (mm)

**DATE**

**B SERIES**

**SUPERSEDES**

**DRAWING NO**

11 - 6 - 23

3300

8 - 3 - 23

33SZ-1A



**FAN POWERED CHILLED WATER TERMINAL UNIT**  
**SENSIBLE COOLING (DOAS)**  
**CONSTANT OR VARIABLE VOLUME**  
**MODELS: 33SZ, 33SE AND 33SZW**  
**UNIT SIZES: 40, 50 AND 55**

**DESCRIPTION:**

- Sensible cooling coil on the induced air inlet handles zone sensible load. Opposite side to controls location. Aluminum ripple fins (10 FPI) and 1/2" (13) copper tubes. Hand of coil connection is determined looking in direction of airflow (RH shown).
- 18 ga. (1.31) galvanized steel channel frame with 20 ga. (1.0) casing components.
- 16 ga. (1.61) galvanized steel inclined opposed blade damper. 45° rotation. CW to close.
- Ultra-high efficiency ECM, fan motor. EPIC fan volume controller.
- 3/4" (19) dual density fiberglass installation, exposed edge coated to prevent air erosion. Meets requirements of NFPA 90A and UL 181.
- Access panels top and bottom.
- Multi-point averaging Diamond Flow Sensor. Supplied with balancing tees.
- Discharge opening for flanged duct connection.
- Single point electrical connection.
- Low voltage NEMA 1 type enclosure for factory mounted DDC controls.
- Controls mounted as standard on RH side as shown. Terminals ordered with LH controls (optional) are inverted and discharge duct hanging elevation will therefore change.
- Galvanized steel drip pan integral to sensible coil.
- Filter Frame and 1" (25) disposable filter.

**OPTIONS:**

**CW Coil:**

- 2-Row  4-Row
- 6-Row  8-Row
- Condensate Sensor

**Coil Connections:**

- Right Hand (Default)
- Left Hand

**Liner:**

- Fiber-free
- Steri-liner
- Steri-liner + Perforated metal
- Perforated metal
- Solid metal

**Filter:**

- 1" (25) Throwaway
- 2" (51) Pleated MERV 8
- 2" (51) Pleated MERV 13
- Ducted Return Filter Rack (See submittal 33SZ-FR)

**Model 33SZ • Basic Unit**

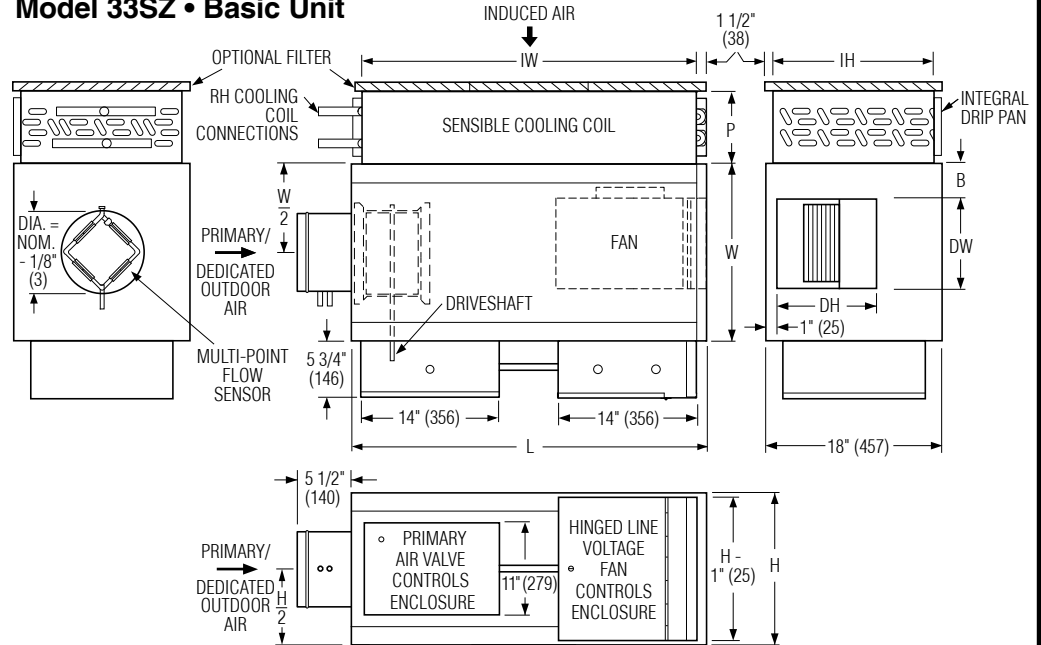

**Dimensional Data**

Unit Size	Inlet Size	W	H	L	B	Cooling Coil IW x IH	P	Outlet Discharge DW x DH	Filter Size
40	4, 5, 6, 8, 10 (102, 127, 152, 203, 254)	18 (457)	18 (457)	36 (914)	3 1/2 (89)	31 x 15 (787 x 381)	2 Row: 5 1/8 (130)	9 1/8 x 10 1/4 (232 x 260)	33 x 16 (838 x 406)
							4 Row: 7 5/16 (186)		
50	4, 5, 6, 8, 10, 12 (102, 127, 152, 203, 254, 305)	26 (660)	18 (457)	41 (1041)	5 (127)	36 x 15 (914 x 381)	6 Row: 9 1/2 (241)	13 1/8 x 11 1/4 (333 x 286)	38 x 16 (965 x 406)
							8 Row: 11 1/2 (292)		
55	4, 5, 6, 8, 10, 12 (102, 127, 152, 203, 254, 305)	26 (660)	18 (457)	55 (1397)	5 (127)	50 x 15 (1270 x 381)	6 Row: 9 1/2 (241)	13 1/8 x 11 1/4 (333 x 286)	52 x 16 (1321 x 406)
							8 Row: 11 1/2 (292)		

**Electrical Data**

Unit Size	EPIC ECM Motor FLA				
	Motor HP	120V	208V	240V	277V
40	*	6.5	4.3	4.2	4.2
50	*	10.5	6.8	6.2	6.0
55	*	9.5	6.4	6.2	6.0

**CW Coil O.D. Sweat Connections**

Unit Size	No. of Row
	2, 4, 6 & 8
40, 50, 55	7/8" (22)

\* The EPIC ECM is a variable horsepower motor. Refer to Selectworks schedule for actual power consumption. FLA = Full load amperage. All motors are single phase/60 Hz.

**Electrical:**

- LH Controls enclosure
- Toggle disconnect switch
- FN3 - Remote line voltage enclosure
- Motor fusing

**Other:**

- Cross Flow Sensor
- Hanger brackets
- 1/4-turn fasteners (access panel).
- Dust tight enclosure seal
- Induced Air Silencer (See submittal 33SZ-DSI)
- Induced Air Silencer Elbow (See submittal 33SZ-DSIE)

**Seismic Certification:**

- Seismic Source International (Standard)
- HCAI (formerly OSHPD, California)
- Special Features: \_\_\_\_\_



**Intertek**

For heat options; see page 2. Dimensions are in inches (mm).

<b>SCHEDULE TYPE:</b>				
<b>PROJECT:</b>				
<b>ENGINEER:</b>		<b>DATE</b>	<b>B SERIES</b>	<b>SUPERSEDES</b>
<b>CONTRACTOR:</b>		2 - 6 - 23	3300	6 - 6 - 22
				<b>DRAWING NO.</b>
				33SZ-2



**FAN POWERED CHILLED WATER TERMINAL UNIT**  
**SENSIBLE COOLING (DOAS)**  
**CONSTANT OR VARIABLE VOLUME**  
**MODELS: 33SZ AND 33SZW**  
**UNIT SIZES: 40, 50 AND 55**

**Hot Water Coil Section**  
**Model 33SZW**

**Standard Features:**

- Coil section installed on unit discharge.
- Coil (and header on multi-circuit units) is installed in insulated casing for increased thermal efficiency.
- 1/2" (13) copper tubes.
- Aluminum ripple fins @ 10 FPI.
- Sweat Connections:  
 Size 40 one row: 1/2" (13) O.D. male solder. All others: 7/8" (22) O.D. male solder.
- Flanged outlet duct connection.

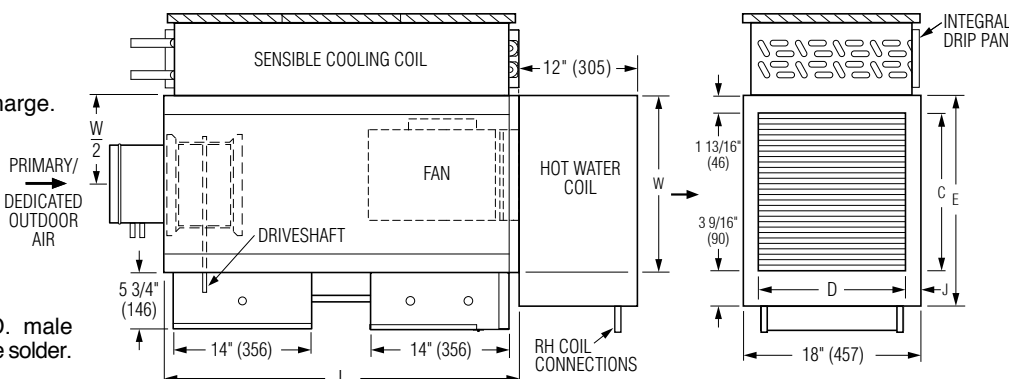

**Coil Rows:**

- 1-Row    2-Row

**Coil Hand Connections:**

(Looking in direction of airflow).

- Right Hand (illustrated). Standard.  
 Left Hand. Optional.

Heating coil, sensible coil and controls enclosure orientation must all be specified separately.

**Dimensional Data**

Unit Size	W	L	Outlet Duct Size C x D	J	E
40	18 (457)	36 (914)	16 x 14 7/8 (406 x 378)	1 1/2 (38)	21 3/8 (543)
50	26 (660)	41 (1041)	24 x 14 7/8 (610 x 378)	1 1/2 (38)	29 3/8 (746)
55	26 (660)	55 (1397)	24 x 14 7/8 (610 x 378)	1 1/2 (38)	29 3/8 (746)

**Electric Coil Section**  
**Model 33SZE**

**Standard Features:**

- Unique hinged heater design permits easy access, removal and replacement of heater element without disturbing ductwork.
- Coil installed on unit discharge.
- Insulated coil element wrapper.
- Automatic reset high limit cut-outs (one per element).
- Single point electrical connection for entire terminal unit.
- Magnetic contactors per stage.
- Class A 80/20 Ni/Cr wire.
- Electronic Fan Interlock Relay.
- Flanged outlet duct connection.
- Terminal unit with coil is ETL listed as on assembly.
- Controls mounted as standard on RH side as shown. Terminals ordered with L.H. controls (optional) are inverted and discharge duct hanging elevation will change.

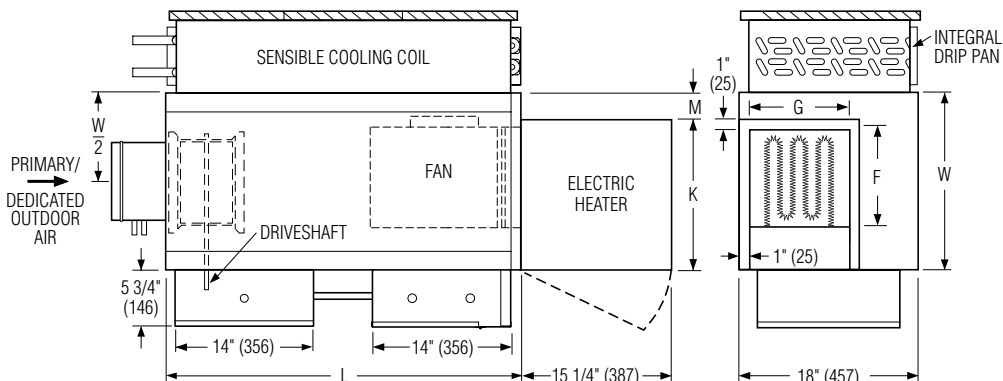

**Dimensional Data**

Unit Size	W	L	K	M	Outlet Duct Size F x G
40	18 (457)	36 (914)	15 1/2 (394)	2 1/2 (64)	10 1/4 x 10 1/2 (260 x 267)
50	26 (660)	41 (1041)	22 (559)	4 (102)	14 1/4 x 11 3/4 (362 x 298)
55	26 (660)	55 (1397)	22 (559)	4 (102)	14 1/4 x 11 3/4 (362 x 298)

**Voltage:**

- Single phase, 60 Hz.  
 120V    208V  
 240V    277V  
 Three phase, 60 Hz.  
 208V    480V (4 wire wye)  
 600V (dual point connection)  
 \_\_\_\_\_

**Electric Coil Options:**

- SCR control.
- SCR control with discharge temperature control
- Toggle disconnect (includes fan)
- Door interlock disconnect switch
- Quiet contactors
- Main line fusing
- Dust tight construction
- Manual Reset secondary thermal cut out
- Positive Pressure airflow switch

**SCHEDULE TYPE:**

**PROJECT:**

**ENGINEER:**

**CONTRACTOR:**

Page 2 of 3.

Dimensions are in inches (mm).

**DATE**

**B SERIES**

**SUPERSEDES**

**DRAWING NO.**

2 - 6 - 23

3300

6 - 6 - 22

33SZ-2



**FAN POWERED CHILLED WATER TERMINAL UNITS  
ORIENTATIONS  
MODELS: 33SZE AND 33SZW  
UNIT SIZES: 40, 50 AND 55**

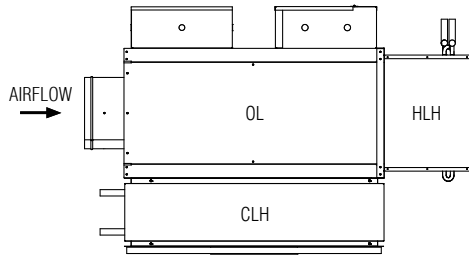

**OL** LEFT HAND CONTROLS  
**CLH** LEFT HAND COOLING COIL CONNECTIONS  
**HLH** LEFT HAND HEATING COIL CONNECTIONS

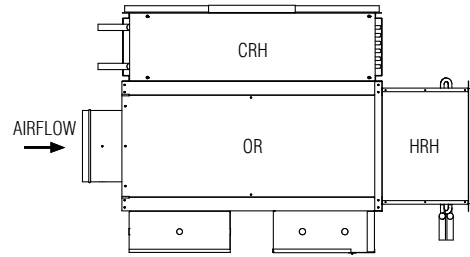

**OR** RIGHT HAND CONTROLS  
**CRH** RIGHT HAND COOLING COIL CONNECTIONS  
**HRH** RIGHT HAND HEATING COIL CONNECTIONS

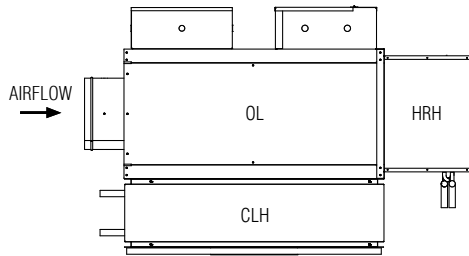

**OL** LEFT HAND CONTROLS  
**CLH** LEFT HAND COOLING COIL CONNECTIONS  
**HRH** RIGHT HAND HEATING COIL CONNECTIONS

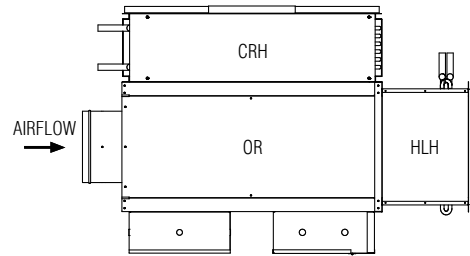

**OR** RIGHT HAND CONTROLS  
**CRH** RIGHT HAND COOLING COIL CONNECTIONS  
**HLH** LEFT HAND HEATING COIL CONNECTIONS

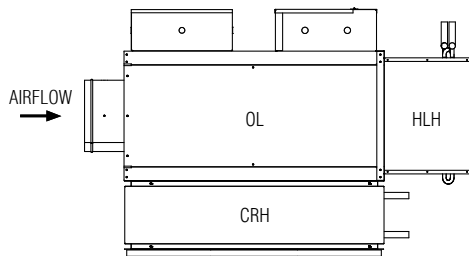

**OL** LEFT HAND CONTROLS  
**CRH** RIGHT HAND COOLING COIL CONNECTIONS  
**HLH** LEFT HAND HEATING COIL CONNECTIONS

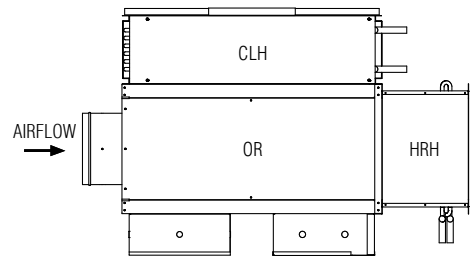

**OR** RIGHT HAND CONTROLS  
**CLH** LEFT HAND COOLING COIL CONNECTIONS  
**HRH** RIGHT HAND HEATING COIL CONNECTIONS

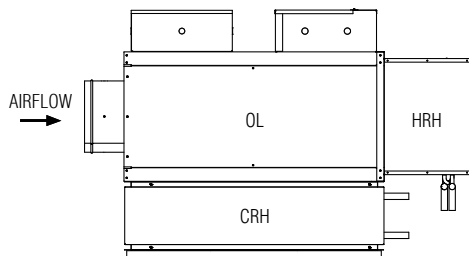

**OL** LEFT HAND CONTROLS  
**CRH** RIGHT HAND COOLING COIL CONNECTIONS  
**HRH** RIGHT HAND HEATING COIL CONNECTIONS

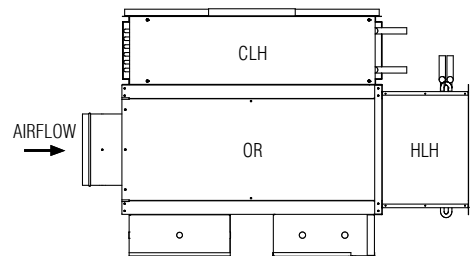

**OR** RIGHT HAND CONTROLS  
**CLH** LEFT HAND COOLING COIL CONNECTIONS  
**HLH** LEFT HAND HEATING COIL CONNECTIONS

**SCHEDULE TYPE:**

**PROJECT:**

**ENGINEER:**

**CONTRACTOR:**

Page 3 of 3.

Dimensions are in inches (mm)

**DATE**

**B SERIES**

**SUPERSEDES**

**DRAWING NO.**

2 - 6 - 23

3300

6 - 6 - 22

33SZ-2



**FAN POWERED CHILLED WATER TERMINAL UNIT**  
**SENSIBLE COOLING (DOAS) • CONSTANT OR VARIABLE VOLUME**  
**MODELS: 33SZ, 33SE AND 33SZW**  
**UNIT SIZES: 10 AND 30 (LOW PROFILE)**  
**WITH 90° LINE VOLTAGE ENCLOSURE (FN2 OPTION)**

**DESCRIPTION:**

- Sensible cooling coil on the induced air inlet handles zone sensible load. Opposite side to controls location. Aluminum ripple fins (10 FPI) and 1/2" (13) copper tubes. Hand of coil connection is determined looking in direction of airflow (RH shown).
- 20 ga. (1.00) galvanized steel construction.
- 16 ga. (1.61) galvanized steel inclined opposed blade damper. 45° rotation. CW to close.
- Ultra-high efficiency ECM fan motor. EPIC fan volume controller.
- 1/2" (13) dual density fiberglass installation, exposed edge coated to prevent air erosion. Meets requirements of NFPA 90A and UL 181.
- Access panels top and bottom.
- Multi-point averaging Diamond Flow Sensor.
- Discharge opening designed for flanged duct connection.
- Single point electrical connection.
- Low voltage NEMA 1 type enclosure for factory mounted DDC controls.
- FN2 line voltage enclosure incorporates a hinged access door opening upstream that helps ensure NEC clearance requirements and reduces footprint.
- Controls mounted as standard on RH side as shown. Unit size 30 ordered with LH controls (optional) is inverted and discharge duct hanging elevation will therefore change.
- Galvanized steel drip pan integral to sensible coil.

**OPTIONS:**

**CW Coil:**

- 2-Row  4-Row
- 6-Row  8-Row
- Condensate Sensor.

**Coil Connections:**

- Right Hand (Default).
- Left Hand.

**Liner:**

- Fiber-free
- Steri-liner
- Steri-liner + Perforated metal
- Perforated metal
- Solid metal

**Model 33SZ • Basic Unit**

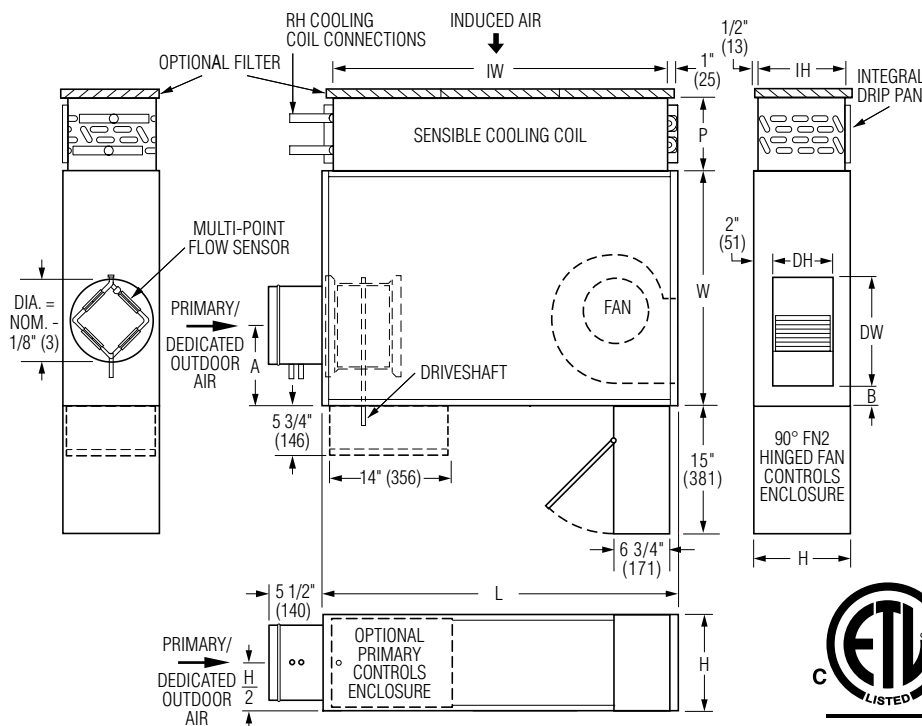

**Dimensional Data**

Unit Size	Inlet Size	W	H	L	A	B	Cooling Coil IW x IH	P	Outlet Discharge DW x DH	Filter Size
10	4, 5, 6 (102, 127, 152)	26 1/2 (673)	8 1/2 (216)	47 1/4 (1200)	5 1/8 (130)	2 (51)	43 x 7 1/2 (1092 x 191)	2 Row: 5 1/8 (130)	7 1/8 x 4 3/4 (181 x 121)	45 x 8 1/2 (1143 x 216)
								4 Row: 7 5/16 (186)		
								6 Row: 9 1/2 (241)		
30	4, 5, 6, 8 (102, 127, 152, 203)	26 1/2 (673)	11 (279)	40 1/4 (1022)	8 (203)	2 (51)	36 x 8 3/4 (914 x 222)	8 Row: 11 11/16 (297)	12 3/8 x 6 7/8 (314 x 175)	38 x 10 (965 x 254)

**Electrical Data**

Unit Size	EPIC ECM Motor FLA				
	Motor HP	120V	208V	240V	277V
10	*	2.2	1.6	1.5	1.5
30	*	7.5	5.0	5.0	4.9

\* The EPIC ECM is a variable horsepower motor. Refer to Selectworks schedule for actual power consumption. FLA = Full load amperage. All motors are single phase/60 Hz.

**Filter:**

- 1" (25) Throwaway.
- 2" (51) Pleated MERV 8.
- 2" (51) Pleated MERV 13.
- Ducted Return Filter Rack (See submittal 33SZ-FR).
- LH Controls enclosure
- Toggle disconnect switch enclosure
- FN3 – Remote line voltage enclosure
- Motor fusing

**CW Coil O.D. Sweat Connections**

Unit Size	No. of Row
10, 30	2, 4, 6 & 8
	7/8" (22)



**Other:**

- Cross Flow Sensor
- Hanger brackets.
- 1/4-turn fasteners (access panel).
- Special Features.
- Induced Air Silencer (See submittal 33SZ-DSI)
- Induced Air Silencer Elbow (See submittal 33SZ-DSIE)

**Seismic Certification (Size 30):**

- Seismic Source International (Standard)
- HCAI (formerly OSHPD, California)
- Special Features: \_\_\_\_\_

**SCHEDULE TYPE:**

**PROJECT:**

**ENGINEER:**

**CONTRACTOR:**

Page 1 of 3; For heat options; see page 2.  
 Dimensions are in inches (mm).

DATE	B SERIES	SUPERSEDES	DRAWING NO.
2 - 6 - 23	3300	7 - 20 - 21	33SZ-3





**FAN POWERED CHILLED WATER TERMINAL UNITS  
ORIENTATIONS  
MODELS: 33SZE AND 33SZW  
UNIT SIZES: 10 AND 30 (LOW PROFILE)  
WITH 90° LINE VOLTAGE ENCLOSURE (FN2 OPTION)**

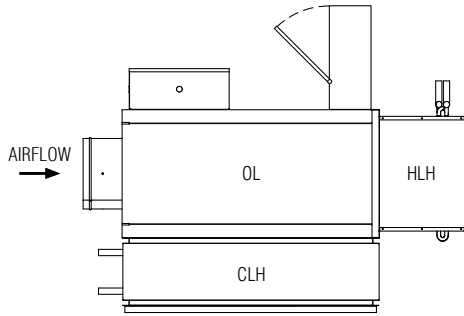

**OL** LEFT HAND CONTROLS  
**CLH** LEFT HAND COOLING COIL CONNECTIONS  
**HLH** LEFT HAND HEATING COIL CONNECTIONS

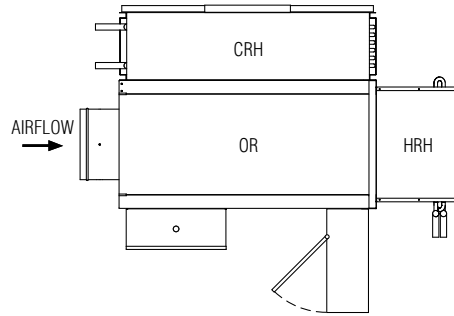

**OR** RIGHT HAND CONTROLS  
**CRH** RIGHT HAND COOLING COIL CONNECTIONS  
**HRH** RIGHT HAND HEATING COIL CONNECTIONS

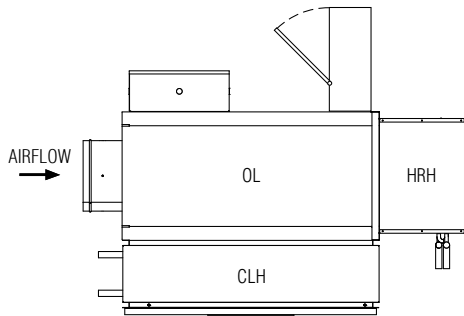

**OL** LEFT HAND CONTROLS  
**CLH** LEFT HAND COOLING COIL CONNECTIONS  
**HRH** RIGHT HAND HEATING COIL CONNECTIONS

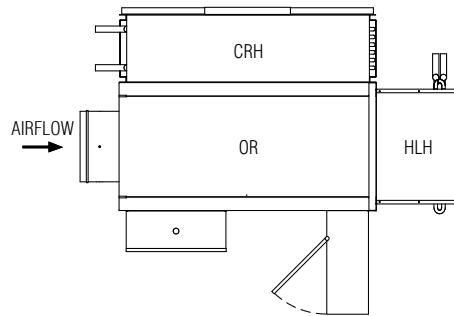

**OR** RIGHT HAND CONTROLS  
**CRH** RIGHT HAND COOLING COIL CONNECTIONS  
**HLH** LEFT HAND HEATING COIL CONNECTIONS

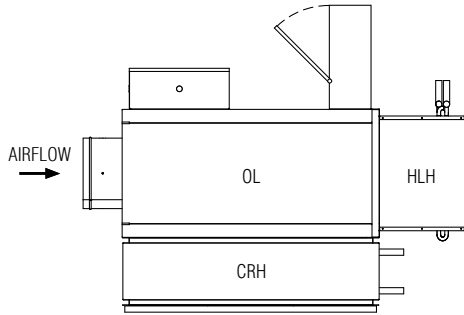

**OL** LEFT HAND CONTROLS  
**CRH** RIGHT HAND COOLING COIL CONNECTIONS  
**HLH** LEFT HAND HEATING COIL CONNECTIONS

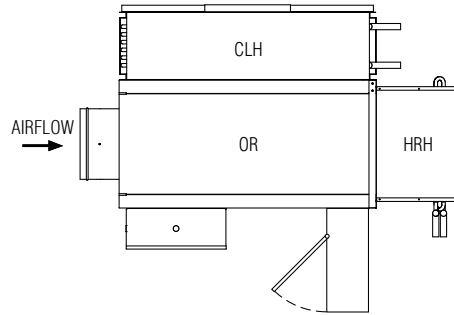

**OR** RIGHT HAND CONTROLS  
**CLH** LEFT HAND COOLING COIL CONNECTIONS  
**HRH** RIGHT HAND HEATING COIL CONNECTIONS

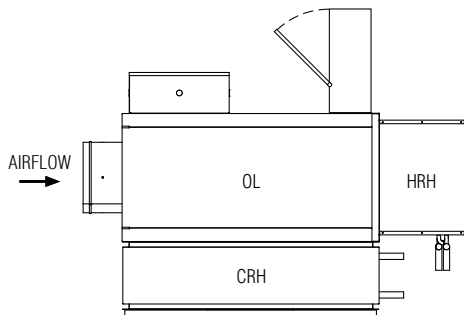

**OL** LEFT HAND CONTROLS  
**CRH** RIGHT HAND COOLING COIL CONNECTIONS  
**HRH** RIGHT HAND HEATING COIL CONNECTIONS

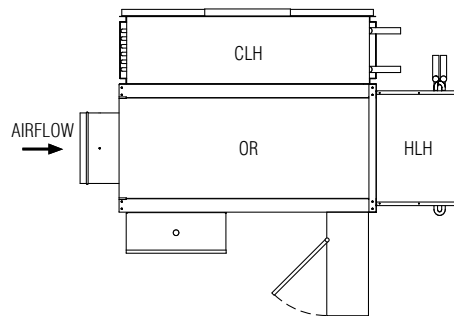

**OR** RIGHT HAND CONTROLS  
**CLH** LEFT HAND COOLING COIL CONNECTIONS  
**HLH** LEFT HAND HEATING COIL CONNECTIONS

**SCHEDULE TYPE:**

**PROJECT:**

**ENGINEER:**

**CONTRACTOR:**

Page 3 of 3.

Dimensions are in inches (mm).

**DATE**

**B SERIES**

**SUPERSEDES**

**DRAWING NO**

2 - 6 - 23

3300

7 - 20 - 21

33SZ-3



**FAN POWERED CHILLED WATER TERMINAL UNIT**  
**SENSIBLE COOLING (DOAS) • CONSTANT OR VARIABLE VOLUME**  
**MODELS: 33SZ, 33SZE AND 33SZW**  
**UNIT SIZE: 35 (LOW PROFILE)**  
**WITH 90° LINE VOLTAGE ENCLOSURE (FN2 OPTION)**

**DESCRIPTION:**

- Sensible cooling coil on the induced air inlet handles zone sensible load. Opposite side to controls location. Aluminum ripple fins (10 FPI) and 1/2" (13) copper tubes. Hand of coil connection is determined looking in direction of airflow (RH shown).
- 20 ga. (1.00) galvanized steel construction.
- 16 ga. (1.61) galvanized steel inclined opposed blade damper. 45° rotation. CW to close.
- Ultra-high efficiency ECM fan motor. EPIC fan volume controller.
- 1/2" (13) dual density fiberglass installation, exposed edge coated to prevent air erosion. Meets requirements of NFPA 90A and UL 181.
- Access panels top and bottom.
- Multi-point averaging Diamond Flow Sensor. Supplied with balancing tees.
- Discharge opening designed for flanged duct connection.
- Single point electrical connection.
- Low voltage NEMA 1 type enclosure for factory mounted DDC controls.
- FN2 line voltage enclosure incorporates a hinged access door opening upstream that helps ensure NEC clearance requirements and reduces footprint.
- Controls mounted as standard on RH side as shown. Unit size 35 ordered with LH controls (optional) is inverted and discharge duct hanging elevation will therefore change.
- Galvanized steel drip pan integral to sensible coil.

**OPTIONS:**

**CW Coil:**

- 2-Row  4-Row
- 6-Row  8-Row
- Condensate Sensor

**Coil Connections:**

- Right Hand (Default)
- Left Hand

**Liner:**

- Fiber-free
- Steri-liner
- Steri-liner + Perforated metal
- Perforated metal
- Solid metal

**Filter:**

- 1" (25) Throwaway
- 2" (51) Pleated MERV 8
- 2" (51) Pleated MERV 13
- Ducted Return Filter Rack (See submittal 33SZ-FR)

**Model 33SZ • Basic Unit**

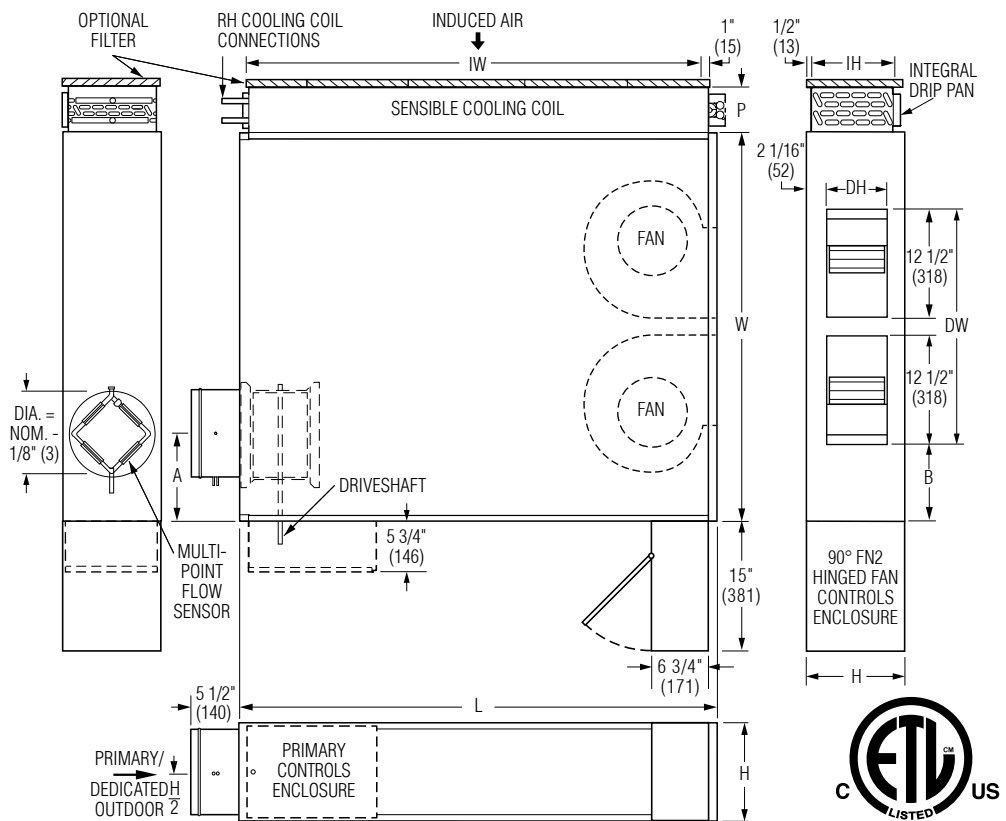

**Intertek**

**Dimensional Data**

Unit Size	Inlet Size	W	H	L	A	B	Cooling Coil IW x IH	P	Outlet Discharge DW x DH	Filter Size
35	4, 5, 6, 8, 10 (102, 127, 152, 203, 254)	44 (1118)	11 (279)	54 (1372)	8 (203)	8 1/2 (216)	50 x 10 (1270 x 254)	2 Row: 5 1/8 (130) 4 Row: 7 5/16 (186) 6 Row: 9 1/2 (241) 8 ROW: 11 1/2 (292)	27 x 6 7/8 (686 x 175)	2@ 26 x 11 (660 x 279)

**Electrical Data**

Unit Size	EPIC ECM Motor FLA				
	Motor HP	120V	208V	240V	277V
35	*	9.4	6.3	6.1	5.8

**CW Coil O.D. Sweat Connections**

Unit Size	No. of Row
35	2, 4, 6 & 8
35	7/8" (22)



\* The EPIC ECM is a variable horsepower motor.  
Refer to Selectworks schedule for actual power consumption.  
FLA = Full load amperage. All motors are single phase/60 Hz.

**Electrical:**

- LH Controls enclosure
- Toggle disconnect switch.
- FN3 – Remote line voltage enclosure.
- Motor fusing.

**Other:**

- Cross Flow Sensor
- Hanger brackets
- 1/4-turn Fasteners (access panel)
- Induced Air Silencer (See submittal 33SZ-DSI)
- Induced Air Silencer Elbow (See submittal 33SZ-DSIE)

**Seismic Certification:**

- Seismic Source International (Standard)
- HCAI (formerly OSHPD, California)
- Special Features:

**SCHEDULE TYPE:**

**PROJECT:**

**ENGINEER:**

**CONTRACTOR:**

Page 1 of 3; For heat options; see page 2.  
Dimensions are in inches (mm).

**DATE**

**B SERIES**

**SUPERSEDES**

**DRAWING NO.**

11 - 6 - 23

3300

8 - 3 - 23

33SZ-3A



**FAN POWERED CHILLED WATER TERMINAL UNIT**  
**SENSIBLE COOLING (DOAS) • CONSTANT OR VARIABLE VOLUME**  
**MODELS: 33SZ, 33SE AND 33SZW**  
**UNIT SIZE: 35 (LOW PROFILE)**  
**WITH 90° LINE VOLTAGE ENCLOSURE (FN2 OPTION)**

**Hot Water Coil Section**  
**Model 33SZW**

**Standard Features:**

- Coil section installed on unit discharge.
- Coil (and header on multi-circuit units) is installed in insulated casing for increased thermal efficiency.
- 1/2" (13) copper tubes.
- Aluminum ripple fins (10 FPI)
- Sweat Connections: One row: 1/2" (13) O.D. male solder. Two row: 5/8" (16) O.D. male solder
- Flanged outlet duct connection.

**Coil Rows:**

- 1-Row     2-Row

**Coil Hand Connections:**

- (Looking in direction of airflow).  
 Right Hand (illustrated). Standard.  
 Left Hand. Optional.

Heating coil, sensible coil and controls enclosure orientation must all be specified separately.

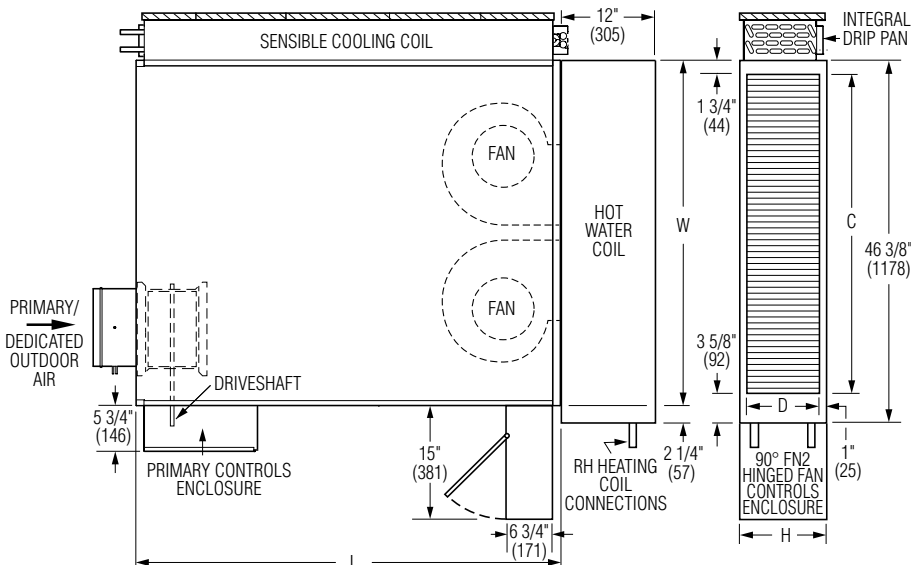

**Dimensional Data**

Unit Size	W	H	L	E	Outlet Duct Size C x D
35	44 (1118)	11 (279)	54 (1372)	46 3/8 (1178)	41 x 9 (1041 x 229)

**Electric Coil Section**  
**Model 33SE**

**Standard Features:**

- Unique hinged heater design permits easy access, removal and replacement of heater element without disturbing ductwork.
- Coil installed on unit discharge.
- Insulated coil element wrapper.
- Automatic reset high limit cut-outs (one per element).
- Single point electrical connection for entire terminal unit.
- Magnetic contactors per stage.
- Class A 80/20 Ni/Cr wire.
- Electronic Fan Interlock Relay.
- Flanged outlet duct connection.
- Terminal unit with coil is ETL listed as on assembly.
- Controls mounted as standard on RH side as shown. Terminals ordered with L.H. controls (optional) are inverted.

**Voltage:**

Single phase, 60 Hz.

- 120V     208V  
 240V     277V

Three phase, 60 Hz.

- 208V     480V (4 wire wye)  
600V (dual point connection)  
 \_\_\_\_\_

**Electric Coil Options:**

- SCR control.
- SCR control with discharge temperature control.
- Toggle disconnect (includes fan).
- Door interlock disconnect switch.
- Quiet contactors.
- Main line fusing.
- Dust tight construction.
- Manual Reset secondary thermal cut out.
- Positive Pressure airflow switch.

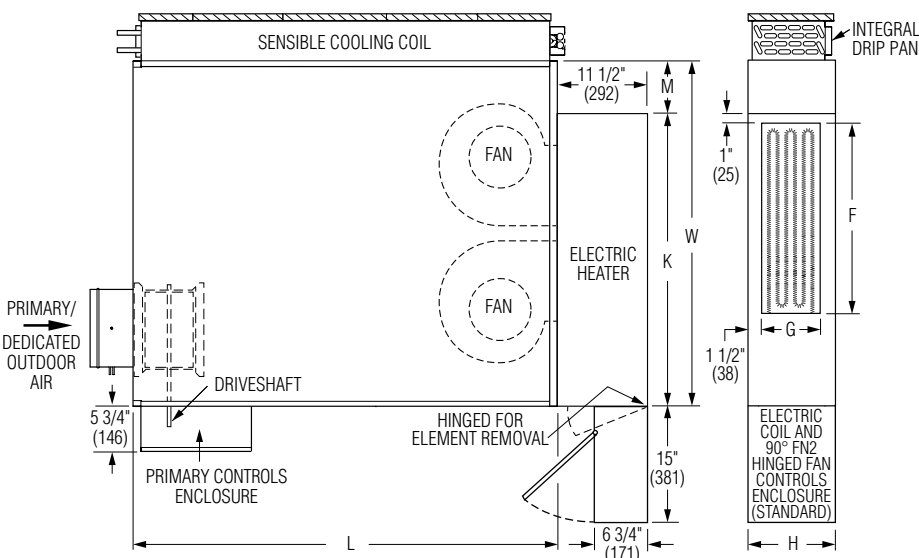

**Dimensional Data**

Unit Size	W	H	L	K	M	Outlet Duct Size F x G
35	44 (1118)	11 (279)	54 (1372)	37 3/8 (949)	6 5/8 (168)	25 x 8 (635 x 203)

**SCHEDULE TYPE:**

**PROJECT:**

**ENGINEER:**

**CONTRACTOR:**

Page 2 of 3.  
Dimensions are in inches (mm).

DATE	B SERIES	SUPERSEDES	DRAWING NO
11 - 6 - 23	3300	8 - 3 - 23	33SZ-3A



**FAN POWERED CHILLED WATER TERMINAL UNITS  
ORIENTATIONS  
MODELS: 33SZE AND 33SZW  
UNIT SIZE: 35 (LOW PROFILE)  
WITH 90° LINE VOLTAGE ENCLOSURE (FN2 OPTION)**

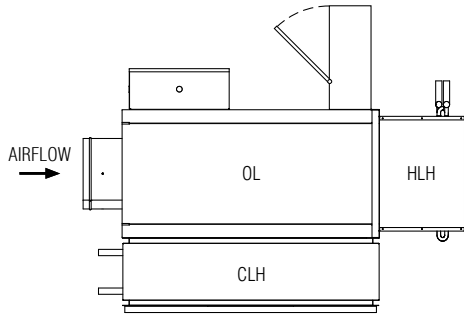

**OL** LEFT HAND CONTROLS  
**CLH** LEFT HAND COOLING COIL CONNECTIONS  
**HLH** LEFT HAND HEATING COIL CONNECTIONS

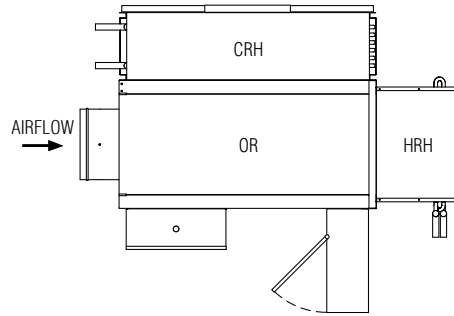

**OR** RIGHT HAND CONTROLS  
**CRH** RIGHT HAND COOLING COIL CONNECTIONS  
**HRH** RIGHT HAND HEATING COIL CONNECTIONS

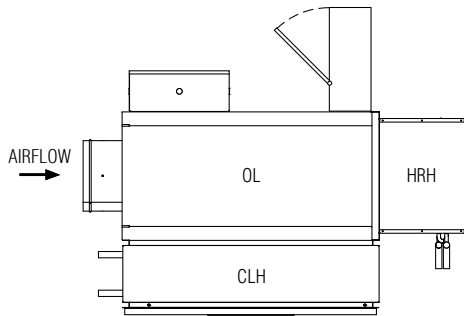

**OL** LEFT HAND CONTROLS  
**CLH** LEFT HAND COOLING COIL CONNECTIONS  
**HRH** RIGHT HAND HEATING COIL CONNECTIONS

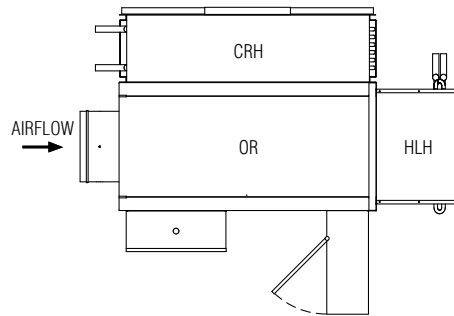

**OR** RIGHT HAND CONTROLS  
**CRH** RIGHT HAND COOLING COIL CONNECTIONS  
**HLH** LEFT HAND HEATING COIL CONNECTIONS

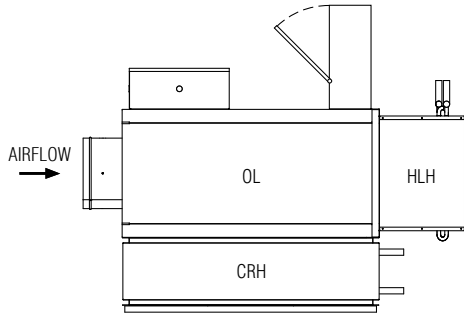

**OL** LEFT HAND CONTROLS  
**CRH** RIGHT HAND COOLING COIL CONNECTIONS  
**HLH** LEFT HAND HEATING COIL CONNECTIONS

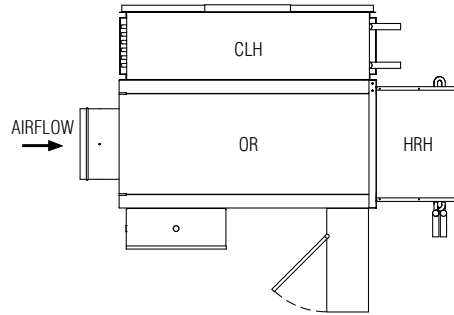

**OR** RIGHT HAND CONTROLS  
**CLH** LEFT HAND COOLING COIL CONNECTIONS  
**HRH** RIGHT HAND HEATING COIL CONNECTIONS

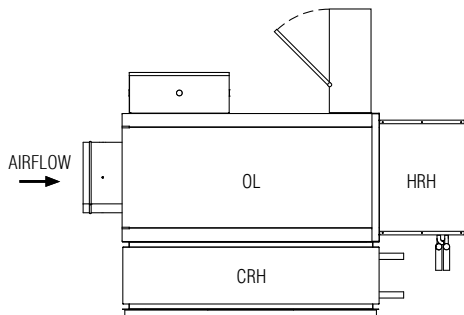

**OL** LEFT HAND CONTROLS  
**CRH** RIGHT HAND COOLING COIL CONNECTIONS  
**HRH** RIGHT HAND HEATING COIL CONNECTIONS

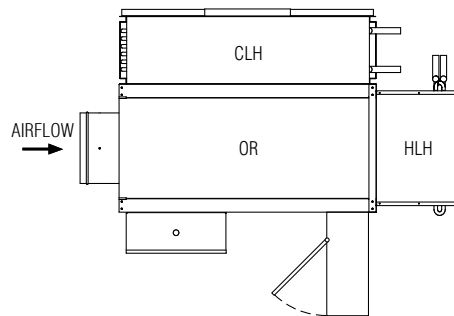

**OR** RIGHT HAND CONTROLS  
**CLH** LEFT HAND COOLING COIL CONNECTIONS  
**HLH** LEFT HAND HEATING COIL CONNECTIONS

**SCHEDULE TYPE:**

**PROJECT:**

**ENGINEER:**

**CONTRACTOR:**

Page 3 of 3.

Dimensions are in inches (mm).

**DATE**

**B SERIES**

**SUPERSEDES**

**DRAWING NO**

11 - 6 - 23

3300

8 - 3 - 23

33SZ-3A



**FAN POWERED CHILLED WATER TERMINAL UNIT**  
**SENSIBLE COOLING (DOAS) • CONSTANT OR VARIABLE VOLUME**  
**MODELS: 33SZ, 33SZE AND 33SZW**  
**UNIT SIZES: 40, 50 AND 55**  
**WITH 90° LINE VOLTAGE ENCLOSURE (FN2 OPTION)**

**DESCRIPTION:**

- Sensible cooling coil on the induced air inlet handles zone sensible load. Opposite side to controls location. Aluminum ripple fins (10 FPI) and 1/2" (13) copper tubes. Hand of coil connection is determined looking in direction of airflow (RH shown).

- 18 ga. (1.31) galvanized steel channel frame with 20 ga. (1.00) casing components.

- 16 ga. (1.61) galvanized steel inclined opposed blade damper. 45° rotation. CW to close.

- Ultra-high efficiency ECM, fan motor. EPIC fan volume controller.

- 3/4" (19) dual density fiberglass installation, exposed edge coated to prevent air erosion. Meets requirements of NFPA 90A and UL 181.

- Access panels top and bottom.

- Multi-point averaging Diamond Flow Sensor. Supplied with balancing tees.

- Discharge opening for flanged duct connection.

- Single point electrical connection.

- Low voltage NEMA 1 type enclosure for factory mounted DDC controls.

- FN2 line voltage enclosure incorporates a hinged access door opening upstream that helps ensure NEC clearance requirements and reduces footprint.

- Controls mounted as standard on RH side as shown. Terminals ordered with LH controls (optional) are inverted and discharge duct hanging elevation will therefore change.

- Galvanized steel drip pan integral to sensible coil.

- Filter Frame and 1" (25) disposable filter.

**OPTIONS:**

**CW Coil:**

- 2-Row  4-Row
- 6-Row  8-Row

Condensate Sensor

**Coil Connections:**

- Right Hand (Default)
- Left Hand

**Liner:**

- Fiber-free
- Steri-liner
- Steri-liner + Perforated metal
- Perforated metal
- Solid metal

**Model 33SZ • Basic Unit**

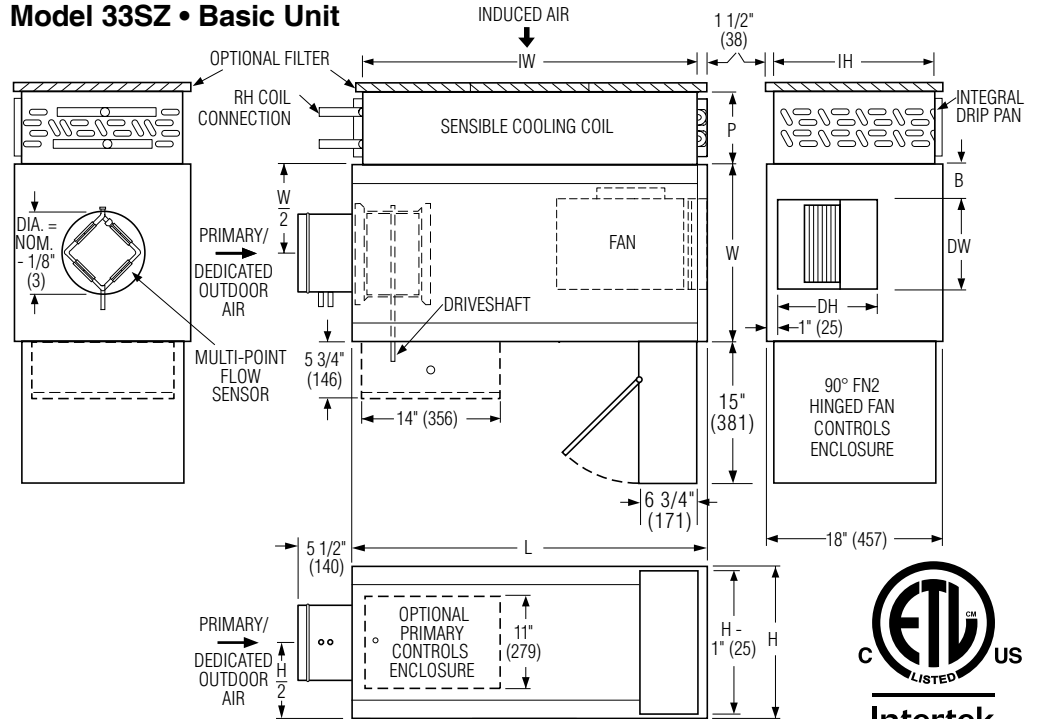

**Dimensional Data**

Unit Size	Inlet Size	W	H	L	B	Cooling Coil IW x IH	P	Outlet Discharge DW x DH	Filter Size
40	4, 5, 6, 8, 10 (102, 127, 152, 203, 254)	18 (457)	18 (457)	36 (914)	3 1/2 (89)	31 x 15 (787 x 381)	2 Row: 5 1/8 (130)	9 1/8 x 10 1/4 (232 x 260)	33 x 16 (838 x 406)
							4 Row: 7 5/16 (186)		
50	4, 5, 6, 8, 10, 12 (102, 127, 152, 203, 254, 305)	26 (660)	18 (457)	41 (1041)	5 (127)	36 x 15 (914 x 381)	6 Row: 9 1/2 (241)	13 1/8 x 11 1/4 (333 x 286)	38 x 16 (965 x 406)
							8 Row: 11 1/2 (292)		
55	4, 5, 6, 8, 10, 12 (102, 127, 152, 203, 254, 305)	26 (660)	18 (457)	55 (1397)	5 (127)	50 x 15 (1270 x 381)	6 Row: 9 1/2 (241)	13 1/8 x 11 1/4 (333 x 286)	52 x 16 (1321 x 406)
							8 Row: 11 1/2 (292)		

**Electrical Data**

Unit Size	EPIC ECM Motor FLA				
	Motor HP	120V	208V	240V	277V
40	*	6.5	4.3	4.2	4.2
50	*	10.5	6.8	6.2	6.0
55	*	9.5	6.4	6.2	6.0

\* The EPIC ECM is a variable horsepower motor. Refer to Selectworks schedule for actual power consumption. FLA = Full load amperage. All motors are single phase/60 Hz.

**Filter:**

- 1" (25) Throwaway.
- 2" (51) Pleated MERV 8.
- 2" (51) Pleated MERV 13.
- Ducted Return Filter Rack (See submittal 33SZ-FR).

**Electrical:**

- LH Controls enclosure
- Toggle disconnect switch.
- FN3 - Remote line voltage enclosure.
- Motor fusing.

**CW Coil O.D. Sweat Connections**

Unit Size	No. of Row
40, 50, 55	2, 4, 6 & 8
	7/8" (22)



**Other:**

- Cross Flow Sensor
- Hanger brackets
- 1/4-turn fasteners (access panel).
- Induced Air Silencer (See submittal 33SZ-DSI)
- Induced Air Silencer Elbow (See submittal 33SZ-DSIE)
- Seismic Certification:**
  - Seismic Source International (Standard)
  - HCAI (formerly OSHPD, California)
  - Special Features: \_\_\_\_\_

Page 1 of 3; For heat options; see page 2. Dimensions are in inches (mm).

<b>SCHEDULE TYPE:</b>				
<b>PROJECT:</b>				
<b>ENGINEER:</b>		<b>DATE</b>	<b>B SERIES</b>	<b>SUPERSEDES</b>
<b>CONTRACTOR:</b>		2 - 6 - 23	3300	6 - 6 - 22
				<b>DRAWING NO.</b>
				33SZ-4



**FAN POWERED CHILLED WATER TERMINAL UNIT**  
**SENSIBLE COOLING (DOAS) • CONSTANT OR VARIABLE VOLUME**  
**MODELS: 33SZE AND 33SZW**  
**UNIT SIZES: 40, 50 AND 55**  
**WITH 90° LINE VOLTAGE ENCLOSURE (FN2 OPTION)**

**Hot Water Coil Section**  
**Model 33SZW**

**Standard Features:**

- Coil section installed on unit discharge.
- Coil (and header on multi-circuit units) is installed in insulated casing for increased thermal efficiency.
- 1/2" (13) copper tubes.
- Aluminum ripple fins @ 10 FPI.
- Sweat Connections:  
 Size 40 one row: 1/2" (13) O.D. male solder. All others: 7/8" (22) O.D. male solder.
- Flanged outlet duct connection.

**Coil Rows:**

- 1-Row    2-Row

**Coil Hand Connections:**

- (Looking in direction of airflow).
- Right Hand (illustrated). Standard.
  - Left Hand. Optional.

Heating coil, sensible coil and controls enclosure orientation must all be specified separately.

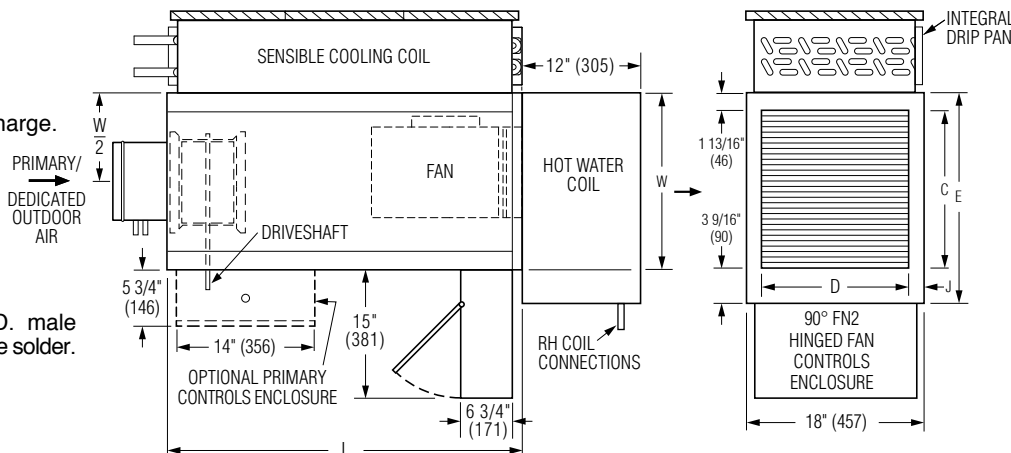

**Dimensional Data**

Unit Size	W	L	Outlet Duct Size C x D	J	E
40	18 (457)	36 (914)	16 x 14 7/8 (406 x 378)	1 1/2 (38)	21 3/8 (543)
50	26 (660)	41 (1041)	24 x 14 7/8 (610 x 378)	1 1/2 (38)	29 3/8 (746)
55	26 (660)	55 (1397)	24 x 14 7/8 (610 x 378)	1 1/2 (38)	29 3/8 (746)

**Electric Coil Section**  
**Model 33SZE**

**Standard Features:**

- Unique hinged heater design permits easy access, removal and replacement of heater element without disturbing ductwork.
- Coil installed on unit discharge.
- Insulated coil element wrapper.
- Automatic reset high limit cut-outs (one per element).
- Single point electrical connection for entire terminal unit.
- Magnetic contactors per stage.
- Class A 80/20 Ni/Cr wire.
- Electronic Fan Interlock Relay.
- Flanged outlet duct connection.
- Terminal unit with coil is ETL listed as on assembly.
- Controls mounted as standard on RH side as shown. Terminals ordered with L.H. controls (optional) are inverted and discharge duct hanging elevation will change.

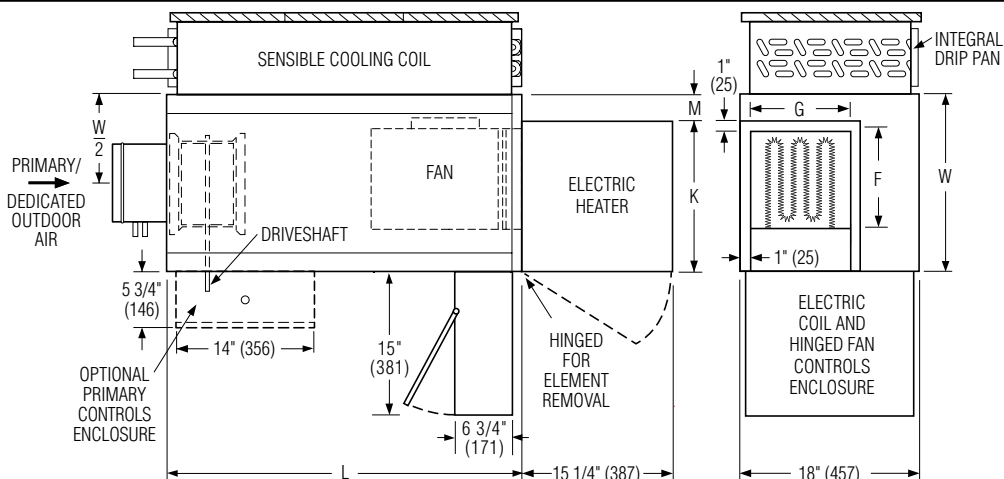

**Dimensional Data**

Unit Size	W	L	K	M	Outlet Duct Size F x G
40	18 (457)	36 (914)	15 1/2 (394)	2 1/2 (64)	10 1/4 x 10 1/2 (260 x 267)
50	26 (660)	41 (1041)	22 (559)	4 (102)	14 1/4 x 11 3/4 (362 x 298)
55	26 (660)	55 (1397)	22 (559)	4 (102)	14 1/4 x 11 3/4 (362 x 298)

**Voltage:**

- Single phase, 60 Hz.  
 120V    208V    240V    277V  
 Three phase, 60 Hz.  
 208V    480V (4 wire wye)  
 600V (dual point connection).  
 \_\_\_\_\_ .

**Electric Coil Options:**

- SCR control.
- SCR control with discharge temperature control.
- Toggle disconnect (includes fan).
- Door interlock disconnect switch.
- Quiet contactors.
- Main line fusing.
- Dust tight construction.
- Manual Reset secondary thermal cut out.
- Positive Pressure airflow switch.

**SCHEDULE TYPE:**

**PROJECT:**

**ENGINEER:**

**CONTRACTOR:**

Page 2 of 3.  
 Dimensions are in inches (mm).

DATE	B SERIES	SUPERSEDES	DRAWING NO.
2 - 6 - 23	3300	6 - 6 - 22	33SZ-4



**FAN POWERED CHILLED WATER TERMINAL UNITS  
ORIENTATIONS  
MODELS: 33SZE AND 33SZW  
UNIT SIZES: 40, 50 AND 55  
WITH 90° LINE VOLTAGE ENCLOSURE (FN2 OPTION)**

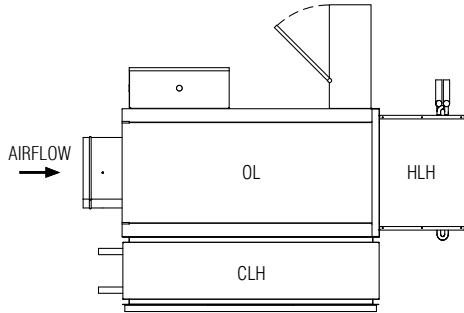

**OL** LEFT HAND CONTROLS  
**CLH** LEFT HAND COOLING COIL CONNECTIONS  
**HLH** LEFT HAND HEATING COIL CONNECTIONS

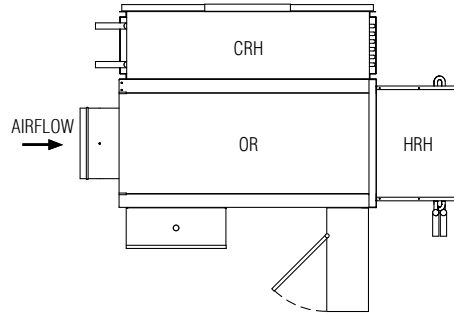

**OR** RIGHT HAND CONTROLS  
**CRH** RIGHT HAND COOLING COIL CONNECTIONS  
**HRH** RIGHT HAND HEATING COIL CONNECTIONS

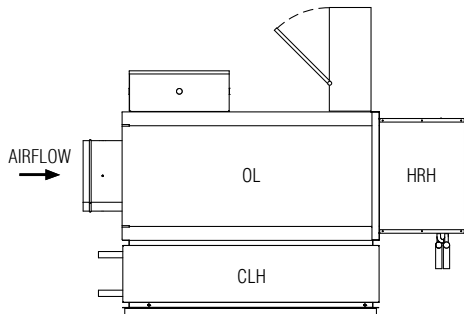

**OL** LEFT HAND CONTROLS  
**CLH** LEFT HAND COOLING COIL CONNECTIONS  
**HRH** RIGHT HAND HEATING COIL CONNECTIONS

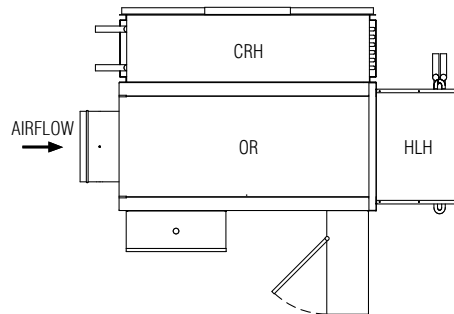

**OR** RIGHT HAND CONTROLS  
**CRH** RIGHT HAND COOLING COIL CONNECTIONS  
**HLH** LEFT HAND HEATING COIL CONNECTIONS

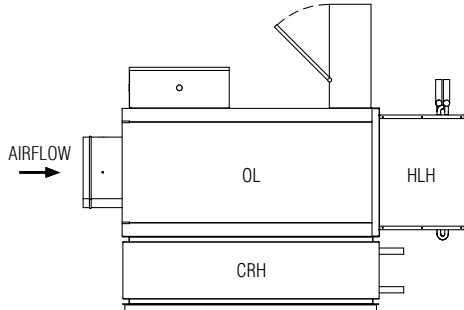

**OL** LEFT HAND CONTROLS  
**CRH** RIGHT HAND COOLING COIL CONNECTIONS  
**HLH** LEFT HAND HEATING COIL CONNECTIONS

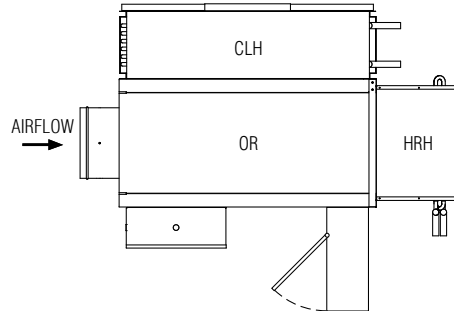

**OR** RIGHT HAND CONTROLS  
**CLH** LEFT HAND COOLING COIL CONNECTIONS  
**HRH** RIGHT HAND HEATING COIL CONNECTIONS

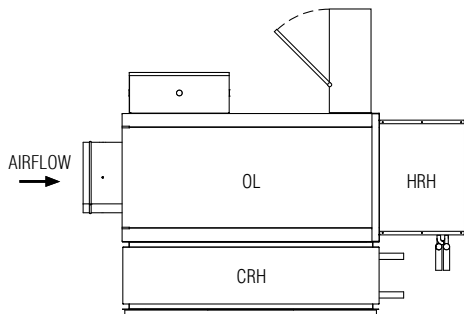

**OL** LEFT HAND CONTROLS  
**CRH** RIGHT HAND COOLING COIL CONNECTIONS  
**HRH** RIGHT HAND HEATING COIL CONNECTIONS

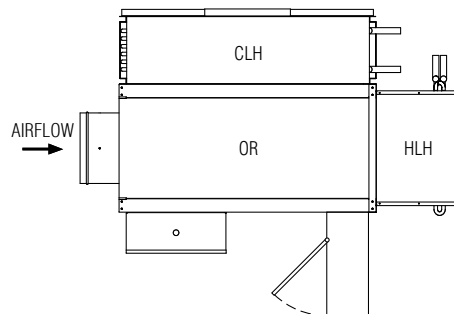

**OR** RIGHT HAND CONTROLS  
**CLH** LEFT HAND COOLING COIL CONNECTIONS  
**HLH** LEFT HAND HEATING COIL CONNECTIONS

**SCHEDULE TYPE:**

**PROJECT:**

**ENGINEER:**

**CONTRACTOR:**

Page 3 of 3.

Dimensions are in inches (mm).

**DATE**

**B SERIES**

**SUPERSEDES**

**DRAWING NO**

2 - 6 - 23

3300

6 - 6 - 22

33SZ-4



**FAN POWERED CHILLED WATER TERMINAL UNITS  
DISCHARGE SOUND ATTENUATORS  
MODEL SERIES: 33SZ**

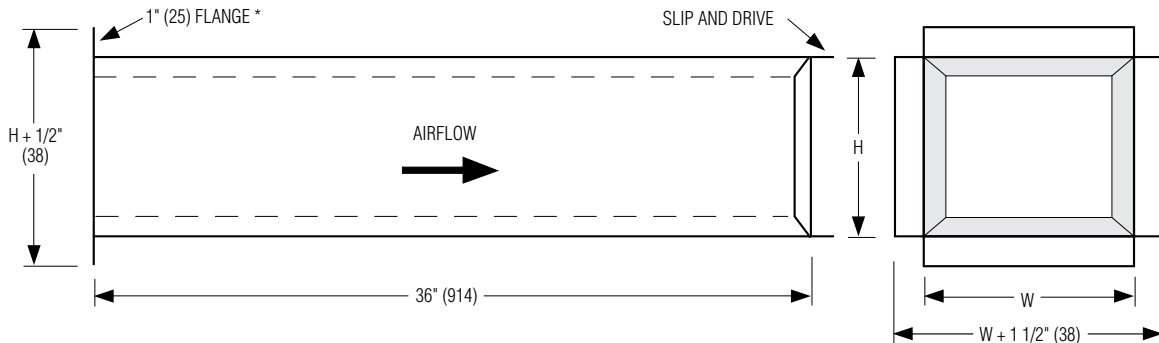

**Dimensional Data**

Unit Size	Duct Size W x H		
	Model AT33SZ	Model AT33SZE	Model AT33SZW
	33SZ	33SZE	33SZW
10	8 1/4 x 6 (210 x 152)		24 x 7 (610 x 178)
30	14 x 9 (356 x 229)		24 x 9 (610 x 229)
35	28 x 9 (711 x 229)		42 x 9 (1067 x 229)
40	10 1/4 x 10 1/2 (260 x 267)		19 1/4 x 15 (489 x 381)
50	14 1/4 x 11 3/4 (362 x 298)		24 x 15 (610 x 381)
55	14 1/4 x 11 3/4 (362 x 298)		24 x 15 (610 x 381)

**DESCRIPTION:**

- 22 ga. (0.86) galvanized steel construction.  
Mechanically sealed, low leakage construction.
- Attenuators are 36" (914) in length.
- Standard liner is dual density fiberglass insulation, treated to prevent erosion. Exposed edges are sealed. Insulation meets requirements of NFPA90A and UL 181.  
Insulation Thickness:  
Unit sizes: 10, 30, 35 (Low profile) 1/2" (13).  
Unit sizes: 40, 50, 55 (Standard height) 3/4" (19).
- Discharge attenuators are shipped loose for field attachment.

**CONNECTIONS:**

Upstream terminal connection has a 3/4" (19) flange.  
Downstream has a slip and drive connection.

**OPTIONS:**

- Unit Sizes: 10, 30, 35 (Low profile)
- FG5** 1/2" (13) Steri-liner
  - FG25** 1/2" (13) Fiberfree liner
  - FGJ5** 1/2" (13) Steri-liner w/ perf.
  - FJ5** 1/2" (13) Perf. metal liner/fiberglass
- Unit Sizes: 40, 50, 55 (Standard height)
- FG** 13/16" (21) Steri-liner
  - FG2** 3/4" (19) Fiberfree liner
  - FG1** 1" (25) Steri-liner
  - FG3** 1" (25) Fiber-free liner
  - FGJ** 13/16" (21) Steri-liner w/ perf.
  - FJ** 3/4" (19) Perforated metal liner/fiberglass
  - FT1** 1" (25) D. D. Fiberglass liner

<b>SCHEDULE TYPE:</b>	Dimensions are in inches (mm)			
<b>PROJECT:</b>				
<b>ENGINEER:</b>	<b>DATE</b>	<b>B SERIES</b>	<b>SUPERSEDES</b>	<b>DRAWING NO.</b>
<b>CONTRACTOR:</b>	5 - 26 - 26	33SZ	6 - 27 - 25	33SZ-DATT



**FAN POWERED CHILLED WATER TERMINAL UNITS  
INDUCED AIR DISSIPATIVE SILENCER  
ACCESSORY CODE DSIF OR DSIM  
MODEL SERIES: 33SZ**

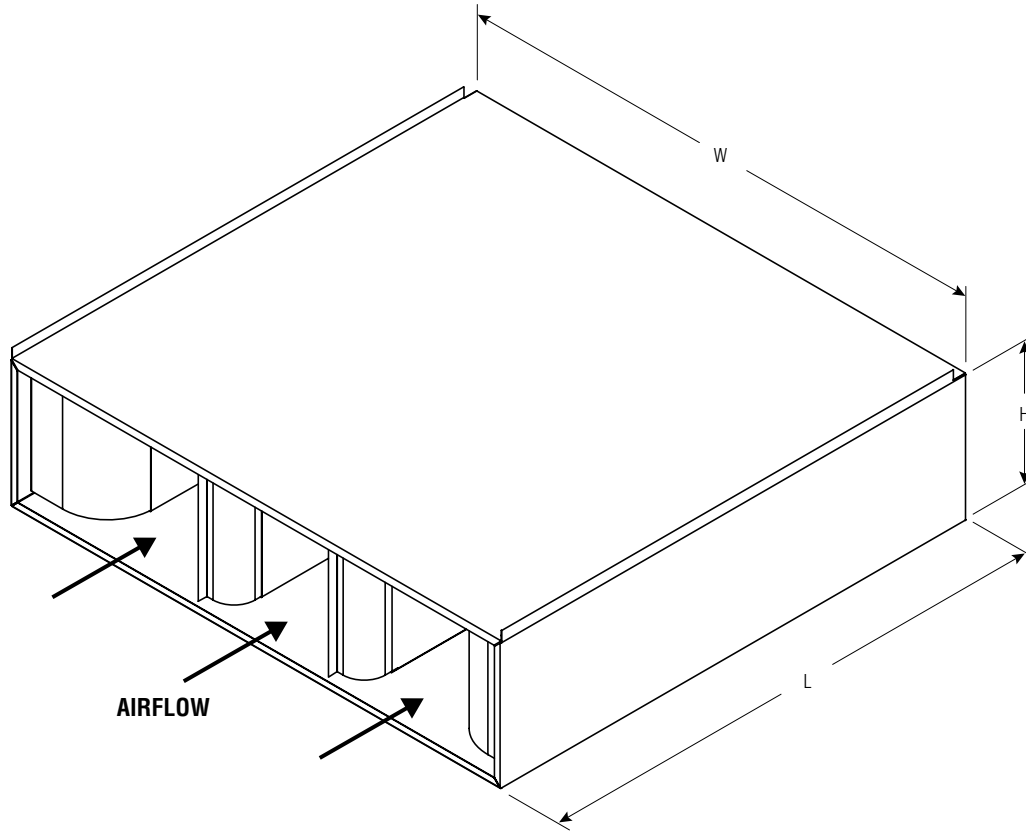

**DESCRIPTION:**

- The DSIF (Induced Air Dissipative Silencer) is an optional induced air inlet accessory for the Fan Powered Chilled Water Terminal Model Series 33SZ and is shipped loose for field attachment.
- The 36" (914) long dissipative silencer provides maximum acoustic attenuation by reducing radiated sound power levels.
- Silencer casing is constructed with 22 ga. (0.86) coated steel.
- Perforated baffles are 13% free area, 22 ga. (0.86) galvanized steel construction. Baffles are filled with fiberglass acoustic media.

**Option:**

- DSIM Mylar/Spacer wrapped fiberglass acoustic media in baffles.

**Dimensional Data**

Unit Size	L	W	H
10	36 (914)	45 (1143)	8 5/8 (219)
30	36 (914)	38 (965)	9 7/8 (251)
35	36 (914)	52 (1321)	11 1/8 (283)
40	36 (914)	33 (838)	16 1/2 (419)
50	36 (914)	38 (965)	16 1/2 (419)
55	36 (914)	52 (1321)	16 1/2 (419)

**Radiated Sound Deductions**

Unit Size	Sound Power Octave Band						Average NC Reduction
	2	3	4	5	6	7	
10	4	8	8	11	10	10	-5
30	4	5	8	11	10	10	
35	4	5	8	11	10	10	
40	5	5	8	11	14	12	
50	5	5	8	9	12	14	
55	5	5	8	9	12	14	

<b>SCHEDULE TYPE:</b>	Dimensions are in inches (mm)			
<b>PROJECT:</b>				
<b>ENGINEER:</b>	<b>DATE</b>	<b>B SERIES</b>	<b>SUPERSEDES</b>	<b>DRAWING NO.</b>
<b>CONTRACTOR:</b>	11 - 3 - 22	33SZ	8 - 4 - 21	33SZ-DSI



**FAN POWERED CHILLED WATER TERMINAL UNITS  
INDUCED AIR DISSIPATIVE ELBOW SILENCER  
ACCESSORY CODE DSIE  
MODEL SERIES: 33SZ**

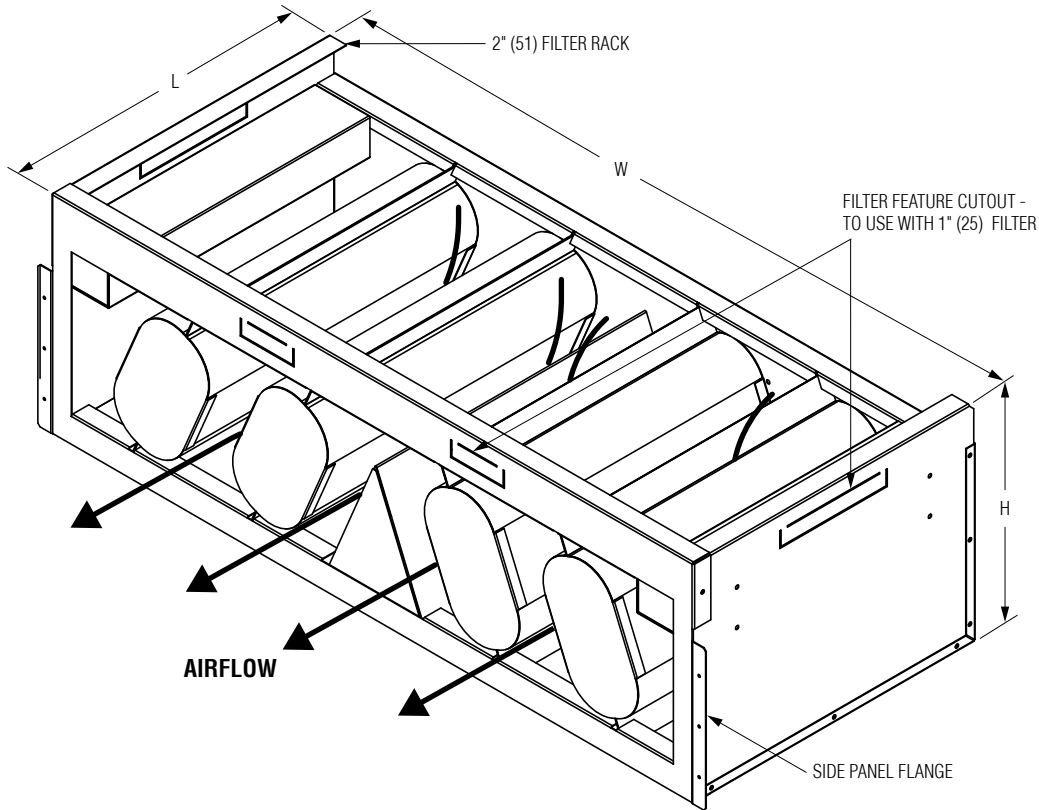

**DESCRIPTION:**

- The DSIE (Induced Air Dissipative Elbow Silencer) is an optional induced air inlet accessory for Fan Powered Chilled Water Terminal Units Model Series 33SZ and is shipped loose for field attachment.
- The compact patent pending elbow design provides maximum acoustic attenuation by reducing radiated sound power levels.
- Silencer casing is constructed with 22 ga. (0.86) coated steel.
- Perforated angled baffles are 13% free area, 22 ga. (0.86) galvanized steel construction. Baffles are filled with fiberglass acoustic media.
- The silencer incorporates a slider-in-filter rack to accommodate a 1" (25) or 2" (51) filter.
- Silencer may be installed in one of two orientations with top entry or bottom entry induced air.

**Dimensional Data**

Unit Size	W	H	L	Filter Size
10	43 5/8 (1108)	10 11/16 (271)	16 (406)	43 1/2 x 16 (1105 x 406)
30	36 5/8 (967)	11 15/16 (303)	16 (406)	36 x 16 (914 x 406)
35	50 1/4 (1276)	13 1/8 (334)	16 (406)	2@ 25 x 16 (635 x 406)
40	33 3/8 (848)	18 1/4 (464)	16 (406)	33 x 16 (838 x 406)
50	37 1/8 (943)	18 1/4 (464)	16 (406)	37 x 16 (940 x 406)
55	52 1/8 (1324)	18 1/4 (464)	16 (406)	52 x 16 (1321 x 406)

**Radiated Sound Deductions**

	Sound Power Octave Band						Average NC Reduction
	2	3	4	5	6	7	
<b>Slanted Attenuator Deduct</b>	2	5	7	6	8	9	3-5

NOTE: Data based upon independent mock-up testing at Energistics Laboratory.

<b>SCHEDULE TYPE:</b>	Dimensions are in inches (mm)			
<b>PROJECT:</b>				
<b>ENGINEER:</b>	<b>DATE</b>	<b>B SERIES</b>	<b>SUPERSEDES</b>	<b>DRAWING NO.</b>
<b>CONTRACTOR:</b>	12 - 1 - 23	33SZ	7 - 13 - 22	33SZ-DSIE



**FAN POWERED CHILLED WATER TERMINAL UNITS  
UNIVERSAL DUCTED RETURN FILTER RACK  
ACCESSORY CODE DRFR  
MODEL SERIES: 33SZ**

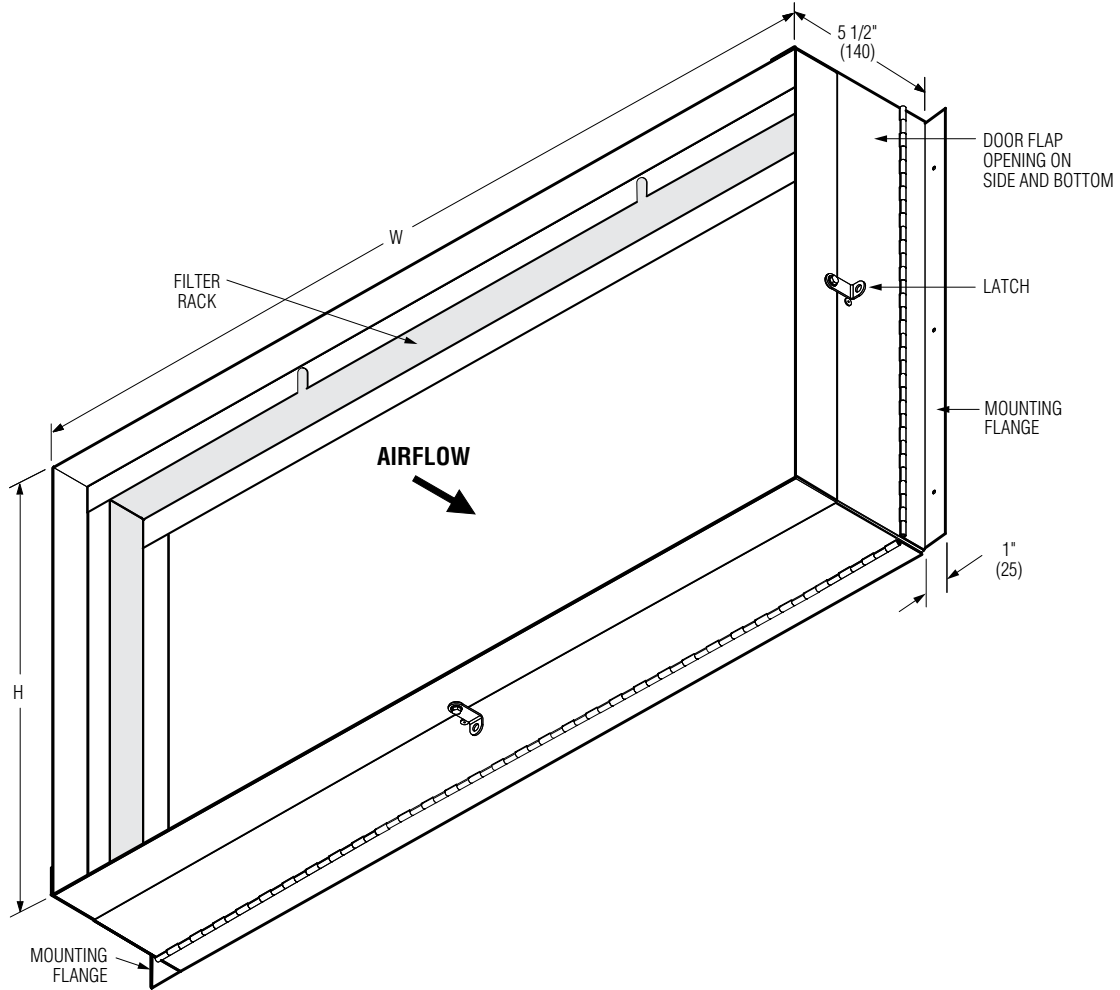

**Description:**

- The DRFR Ducted Return Filter Rack is an optional accessory for the Fan Powered Chilled Water Terminal Model Series 33SZ.
- The accessory is required for ducted inlet applications where a filter is also required and ease of accessibility is required.
- The Ducted Filter Connection features a filter rack, which accommodates a 1" (25) standard or 2" (51) optional filter.
- Factory mounted on the induced air inlet of the draw through water coil section.
- A piano-hinged door flap with latch on the side and bottom of the unit accessory allows for easy removal and replacement of the filter.
- The accessory is provided with a nominally sized duct connection collar.

**Dimensional Data**

Unit Size	Inlet Size W x H	Filter Size W x H
10	45 1/2 x 8 7/8 (1156 x 225)	45 x 8 1/2 (1143 x 216)
30	38 x 10 (965 x 254)	38 x 10 (965 x 254)
35	52 x 10 (1321 x 254)	2 @ 26 x 10 (660 x 254)
40	33 1/8 x 16 1/2 (841 x 419)	33 x 16 (838 x 406)
50	38 1/8 x 16 1/2 (968 x 419)	38 x 16 (965 x 406)
55	52 x 16 1/2 (1321 x 419)	52 x 16 (1321 x 406)

<b>SCHEDULE TYPE:</b>	Dimensions are in inches (mm).			
<b>PROJECT:</b>				
<b>ENGINEER:</b>	<b>DATE</b>	<b>B SERIES</b>	<b>SUPERSEDES</b>	<b>DRAWING NO.</b>
<b>CONTRACTOR:</b>	7 - 14 - 25	33SZ	8 - 4 - 21	33SZ-FR



**FN3 REMOTE LINE VOLTAGE CONTROLS ENCLOSURE**  
**FAN POWERED TERMINAL UNIT OPTION**  
**MODEL SERIES: 33SZ, 35S(ST), 37S(ST), 38F AND 38S**

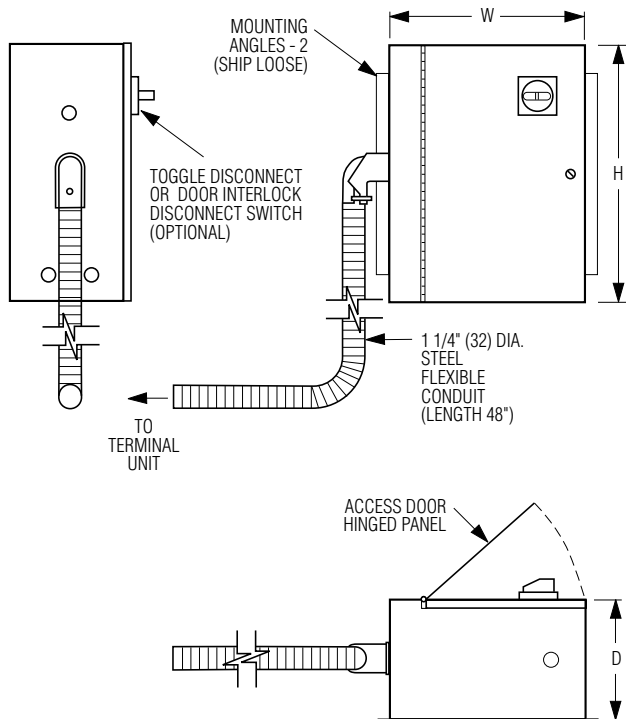

**33SZ / 35S(ST) / 37S(ST) DESIGN**  
**(Ceiling Mounted Terminal Unit)**

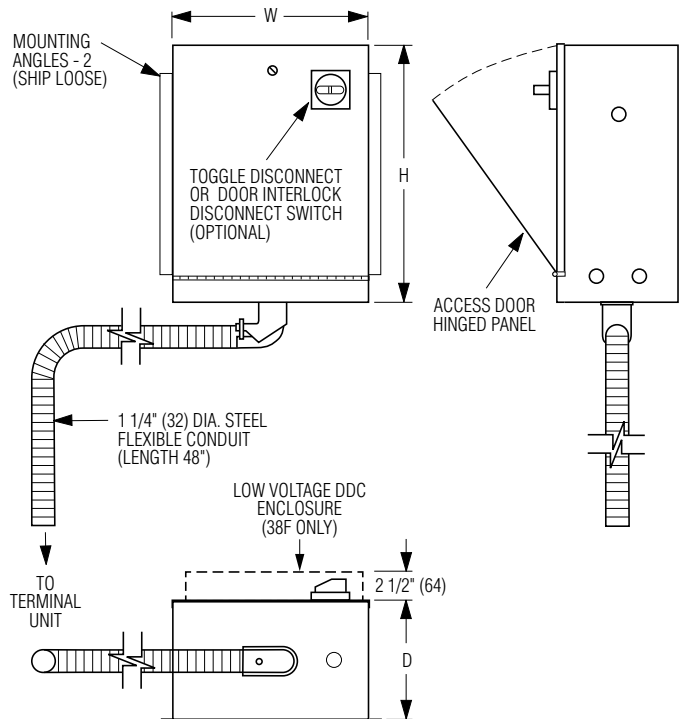

**38F / 38S DESIGN**  
**(Underfloor Terminal Unit)**

**Dimensional Data**

Model Series	Unit Size	W	H	D
33SZ	10	15 (381)	8 1/2 (216)	6 3/4 (171)
	30, 35	15 (406)	11 (279)	6 3/4 (171)
	40, 50, 55	17 (432)	14 (356)	5 3/4 (146)
35S(ST)	1, 2	14 (356)	13 (330)	5 3/4 (146)
	3, 4, 5, 6, 7	14 (356)	17 (432)	5 3/4 (146)
37S(ST)	1, 2, 3, 4	15 (381)	11 (279)	6 3/4 (171)
38F	1, 3, 5, 6, 33, 3S, 3H, 6H, 33H	15 (381)	11 (279)	6 3/4 (171)
38S	1, 3, 5	15 (381)	11 (279)	6 3/4 (171)



**NOTES:**

- The FN3 line voltage enclosure is an ETL listed option. The FN3 was developed for Nailor fan powered terminal units in order to help meet NEC clearance requirements. Standard enclosures are mounted on the side of the unit and effectively add 42" (1067) to the terminals width footprint. Very often there is insufficient clearance in the ceiling plenum due to physical obstructions to accommodate this. The FN3 provides flexibility in that it may be field positioned in any orientation that provides the NEC clearance requirement.
- The FN3 Line voltage enclosure ships loose with a 48" (1219) flexible conduit connection to the terminal unit. The enclosure should be field mounted either on or remote from the terminal unit in a position that meets (NEC) clearance requirements.  
 The controls enclosure is supplied with mounting angles, which ship loose for field attachment.

<b>SCHEDULE TYPE:</b>		Dimensions are in inches (mm)			
<b>PROJECT:</b>					
<b>ENGINEER:</b>	<b>DATE</b>	<b>B SERIES</b>	<b>SUPERSEDES</b>	<b>DRAWING NO.</b>	
<b>CONTRACTOR:</b>	1 - 12 - 22	FN	8 - 3 - 21	FN3	



**TERMINAL UNITS  
LINER OPTIONS  
SOUND POWER LEVEL CORRECTION FACTORS  
TYPE: FIBER-FREE**

**INSULATION CHARACTERISTICS**

Material: Engineered Polymer Foam Insulation (EPFI). Closed cell.  
Zero permeability and water absorption.

Available Thicknesses: 1/2" (13), 3/4" (19), 1" (25) (Consult individual model submittal for thickness used).

Density: 1.5 lb/cu.ft. (24 kg/m<sup>3</sup>).

Thermal Conductivity: 0.27 BTU-in / hr-ft<sup>2</sup>-°F @ 75°F (0.039 W / m-°K @ 24°C).  
(K-Factor)

Thermal Resistance: 1/2" (13): 1.9 hr-ft<sup>2</sup>-°F / BTU (0.33 m<sup>2</sup>-°C / W).  
(R-Value) 3/4" (19): 2.8 hr-ft<sup>2</sup>-°F / BTU (0.49 m<sup>2</sup>-°C / W).  
1" (25): 3.7 hr-ft<sup>2</sup>-°F / BTU (0.65 m<sup>2</sup>-°C / W).

Flame Spread Index: 25

Smoke Developed Index: 50

Mold Growth: None

Erosion: None

**STANDARD AND CODE COMPLIANCE**

- UL 181 Class I
- ASTM E84 and UL 723 Flame/Smoke (25/50)
- NFPA 90A (Heating and Cooling Equipment)
- ASTM C 209
- ASTM C 665

**ACOUSTICAL PERFORMANCE**

Correction factors to cataloged sound power level data (standard liner) are shown below.

**Single Duct Terminal Units • 3000 Series Basic Unit • All sizes.**

Octave Band	2	3	4	5	6	7	NC Impact
Center Frequency (Hz)	125	250	500	1000	2000	4000	(Average)
Discharge Sound	0	0	0	0	0	0	0
Radiated Sound	-1	-2	-2	-3	-3	-3	-2

**Single Duct Terminal Units with Integral Attenuator • 3000 Series • All Sizes.**

Octave Band	2	3	4	5	6	7	NC Impact
Center Frequency (Hz)	125	250	500	1000	2000	4000	(Average)
Discharge Sound	+1	+1	+3	+4	+7	+8	+3
Radiated Sound	-1	-2	-2	-3	-3	-3	-2

**Fan Powered Terminal Units • 33SZ, 35N, 35S, 37N and 37S Series • All sizes.**

Octave Band	2	3	4	5	6	7	NC Impact
Center Frequency (Hz)	125	250	500	1000	2000	4000	(Average)
Discharge Sound	0	0	0	0	0	0	0
Radiated Sound	+2	+2	+4	+2	+2	+2	+3

**Fan Powered Terminal Units • 35SST and 37SST "Stealth" Series • All sizes.**

Octave Band	2	3	4	5	6	7	NC Impact
Center Frequency (Hz)	125	250	500	1000	2000	4000	(Average)
Discharge Sound	0	0	0	0	0	0	0
Radiated Sound	+2	+2	+4	+2	+2	+2	+3

<b>SCHEDULE TYPE:</b>	Dimensions are in inches (mm)			
<b>PROJECT:</b>				
<b>ENGINEER:</b>	<b>DATE</b>	<b>B SERIES</b>	<b>SUPERSEDES</b>	<b>DRAWING NO.</b>
<b>CONTRACTOR:</b>	5 - 12 - 22	VAV.ACC.	4 - 17 - 20	VAV-FF



**TERMINAL UNITS  
LINER OPTIONS  
SOUND POWER LEVEL CORRECTION FACTORS  
TYPE: STERI-LINER**

**INSULATION CHARACTERISTICS**

Material: Rigid board form fiberglass with a thermosetting resin. Fire resistant reinforced aluminum foil-scrim-kraft (FSK) facing.

Available Thicknesses: 1/2" (13), 13/16" (21), 1" (25) (Consult individual model submittal for thickness used).

Density: 4.1 lb/cu.ft. (66 kg/m<sup>3</sup>).

Thermal Conductivity: 0.23 BTU-in / hr-ft<sup>2</sup>-°F @ 75°F (0.033 W / m-°K @ 24°C).  
(K-Factor)

Thermal Resistance: 1/2" (13) - 2.2 hr-ft<sup>2</sup>-°F / BTU (0.48 m<sup>2</sup>-°C / W).  
(R-Value) 13/16" (21) - 3.5 hr-ft<sup>2</sup>-°F / BTU (0.76 m<sup>2</sup>-°C / W).  
1" (25) - 4.3 hr-ft<sup>2</sup>-°F / BTU (0.96 m<sup>2</sup>-°C / W).

Flame Spread Index: 25

Smoke Developed Index: 50

Mold Growth: None

**STANDARD AND CODE COMPLIANCE**

- UL 181 Class I
- ASTM E84, UL 723 Flame/Smoke (25/50) and CAN/ULC S102 (25/50)
- NFPA 90A and 90B
- ASTM C 1071 Air Velocity (2000 fpm max.)
- ASTM C 665
- ASTM C 1338, G21 and G22 Fungi and Bacteria Resistance

**ACOUSTICAL PERFORMANCE**

Correction factors to cataloged sound power level data (standard liner) are shown below.

**Single Duct Terminal Units • 3000 Series Basic Unit • All sizes.**

Octave Band	2	3	4	5	6	7	NC Impact
Center Frequency (Hz)	125	250	500	1000	2000	4000	(Average)
Discharge Sound	0	0	0	0	0	0	0
Radiated Sound	-1	-2	-2	-3	-3	-3	-2

**Single Duct Terminal Units with Integral Attenuator • 3000 Series • All Sizes.**

Octave Band	2	3	4	5	6	7	NC Impact
Center Frequency (Hz)	125	250	500	1000	2000	4000	(Average)
Discharge Sound	+1	+1	+3	+4	+7	+8	+3
Radiated Sound	-1	-2	-2	-3	-3	-3	-2

**Fan Powered Terminal Units • 33SZ, 35N, 35S, 37N and 37S Series • All sizes.**

Octave Band	2	3	4	5	6	7	NC Impact
Center Frequency (Hz)	125	250	500	1000	2000	4000	(Average)
Discharge Sound	0	0	0	0	0	0	0
Radiated Sound	+2	+3	+6	+11	+10	+3	+3

**Fan Powered Terminal Units • 35SST and 37SST "Stealth" Series • All sizes.**

Octave Band	2	3	4	5	6	7	NC Impact
Center Frequency (Hz)	125	250	500	1000	2000	4000	(Average)
Discharge Sound	0	0	0	0	0	0	0
Radiated Sound	-5	-4	-4	0	+3	+5	-4

<b>SCHEDULE TYPE:</b>	Dimensions are in inches (mm)			
<b>PROJECT:</b>				
<b>ENGINEER:</b>	<b>DATE</b>	<b>B SERIES</b>	<b>SUPERSEDES</b>	<b>DRAWING NO.</b>
<b>CONTRACTOR:</b>	5 - 15 - 25	VAV.ACC.	5 - 17 - 22	VAV-SL



**VAV TERMINAL UNITS  
LINER OPTIONS  
TYPE: SOLID METAL LINER  
(DOUBLE WALL CONSTRUCTION)**

A Solid metal liner completely isolates the standard insulation and its raw edges from the airstream within the terminal. The solid metal liner option, also referred to as double wall construction, offers excellent protection against exposure of fiberglass particles to the airstream. This option is ideal for applications where Indoor Air Quality (IAQ) is a concern and where terminals will be wiped down and cleaned on a regular basis. This option is also resistant to moisture.

**ISOLATED INSULATION**

Material: Dual Density flame attenuated glass fiber.  
 Thickness: 3/4" (19). (37N, 37S, 37SST and 33SZ Size 30 Low Profile Fan Powered Terminal Units use 1/2" (13) material).  
 Density: 4.0 lb/cu. ft. (64 kg/m<sup>3</sup>) skin.  
 1.5 lb/cu. ft. (24 kg/m<sup>3</sup>) core.  
 Thermal Conductance: 0.36 BTU / hr-ft<sup>2</sup>-°F @ 75°F (2.04 W / m<sup>2</sup>-°C @ 24°C).  
 (C) For 1/2" (13) material: 0.52 BTU / hr-ft<sup>2</sup>-°F @ 75°F (2.95 W / m<sup>2</sup>-°C @ 24°C).

**STANDARD AND CODE COMPLIANCE**

- UL 181 Class I
- ASTM E84 and UL 723 Flame/Smoke (25/50)
- NFPA 90A and 90B
- ASTM C 1071 Air Velocity (2000 fpm max.)
- ASTM C 665

**ACOUSTICAL PERFORMANCE**

Correction factors to cataloged sound power level data (standard dual density insulation) are shown below.

**Single Duct Terminal Units • 3000 Series Basic Unit • All sizes.**

Octave Band	2	3	4	5	6	7	NC Impact
Center Frequency (Hz)	125	250	500	1000	2000	4000	(Average)
Discharge Sound	0	0	0	0	0	0	0
Radiated Sound	-1	-2	-2	-3	-3	-3	-2

**Fan Powered Terminal Units • 33SZ, 35N, 35S, 37N and 37S Series • All sizes.**

Octave Band	2	3	4	5	6	7	NC Impact
Center Frequency (Hz)	125	250	500	1000	2000	4000	(Average)
Discharge Sound	0	0	0	0	0	0	0
Radiated Sound	+2	+1	+2	+6	+13	+14	+3

**Fan Powered Terminal Units • 35SST and 37SST "Stealth" Series • All sizes.**

Octave Band	2	3	4	5	6	7	NC Impact
Center Frequency (Hz)	125	250	500	1000	2000	4000	(Average)
Discharge Sound	0	0	0	0	0	0	0
Radiated Sound	-5	-4	-4	0	+3	+5	-4

**Dual Duct Terminal Units • 3230 and 3240 "Blendmaster" Series • All sizes.**

Nailor has independently tested and cataloged their dual duct sound data based upon the use of Steri-Liner (high density foil back insulation) rather than standard dual density fiberglass insulation as used in the above terminal units. This is because it is the most popular specification for dual duct terminals, where IAQ is frequently a concern. Solid metal liner is acoustically reflective in a manner similar to Steri-Liner. The cataloged data may therefore be used without correction when a solid metal liner is required.

<b>SCHEDULE TYPE</b>				
<b>PROJECT</b>				
<b>ENGINEER</b>	<b>DATE</b>	<b>B SERIES</b>	<b>SUPERSEDES</b>	<b>DRAWING NO.</b>
<b>CONTRACTOR</b>	<b>8 - 19 - 16</b>	<b>VAV.ACC.</b>	<b>11 - 19 - 12</b>	<b>VAV - SML</b>

## Performance Data

### ECM Motor Fan Curves – Airflow vs. Downstream Static Pressure

#### 33SZ Series • FPCWTU (DOAS)

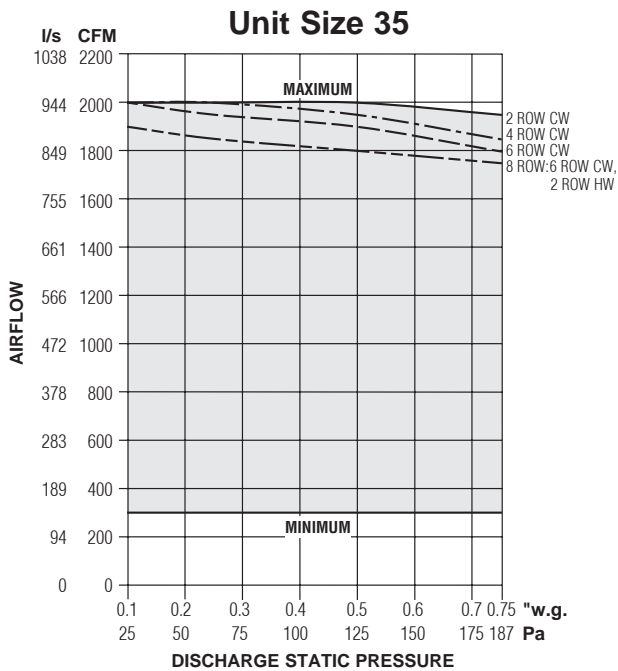
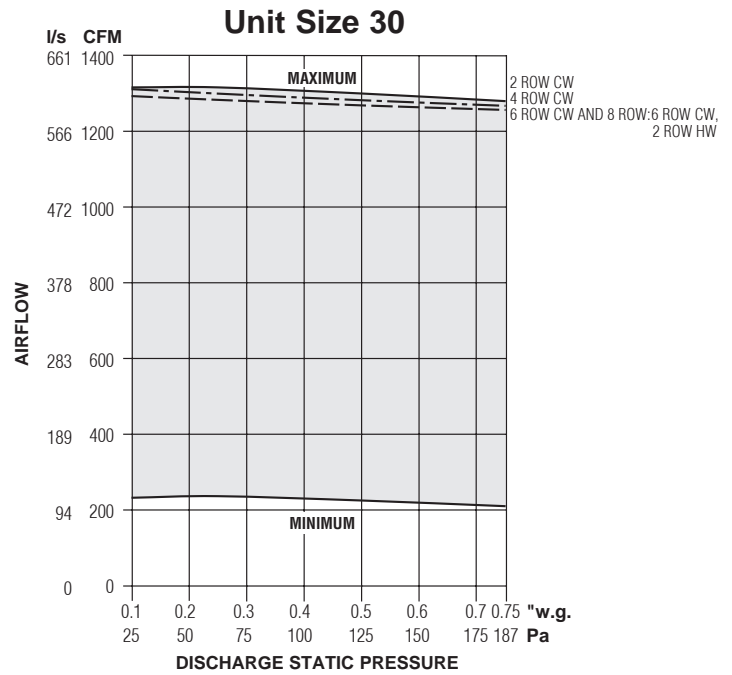
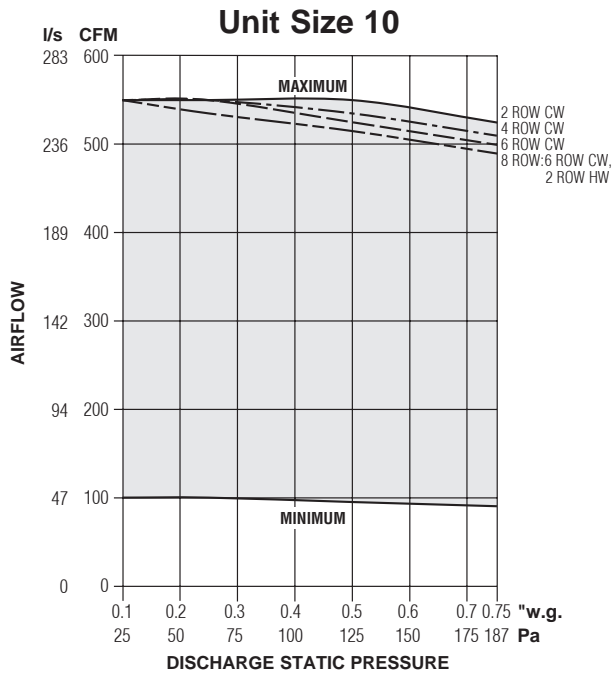

#### Electrical Data

Unit Size	EPIC ECM Motor FLA				
	Motor HP	120V	208V	240V	277V
10	*	2.2	1.6	1.5	1.5
30	*	7.5	5.0	5.0	4.9
35	*	8.2	5.5	5.3	5.3

\* The ECM is a variable horsepower motor.  
 Refer to Selectworks schedule for actual power consumption.  
 FLA = Full load amperage.  
 All motors are single phase/60 Hz.

#### NOTES:

- The ECM is pressure independent and constant volume in operation at factory or field set point within the shaded area. When the setpoint is on or below the respective maximum curve, airflow does not vary with changing static pressure conditions. The motor compensates for any changes in external static pressure or induced air conditions such as filter loading.

- Fan curves shown are applicable to 120, 208, 240 and 277 volt, single phase ECM's. ECM's, although DC in operation, include a built-in AC/DC converter.
- Minimum operation within the dark shaded area is not predictable.

Performance Data

ECM Motor Fan Curves – Airflow vs. Downstream Static Pressure

33SZ Series • FPCWTU (DOAS)

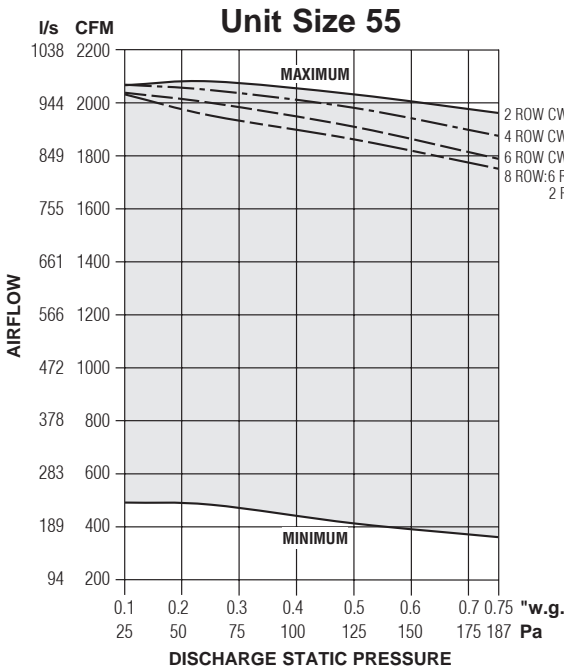
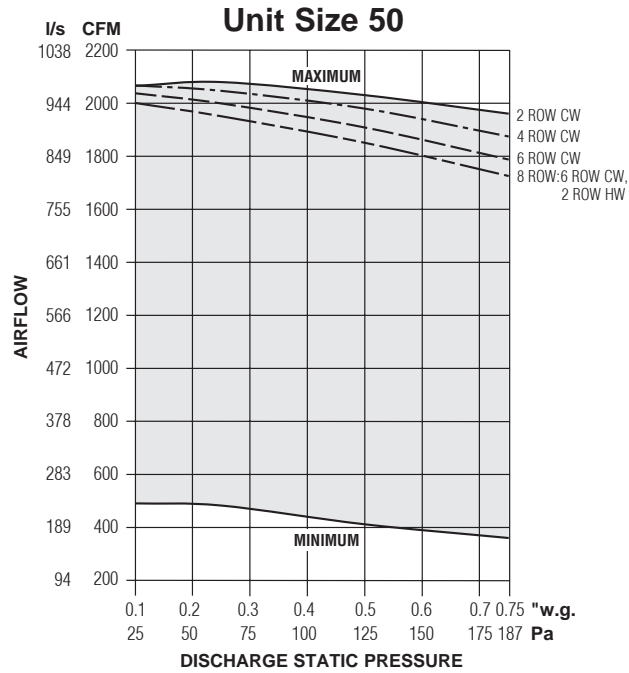
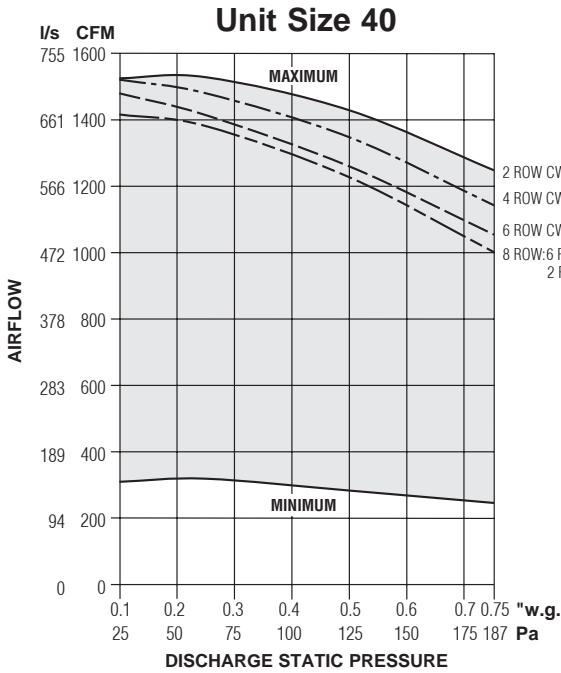

Electrical Data

Unit Size	EPIC ECM Motor FLA				
	Motor HP	120V	208V	240V	277V
40	*	6.5	4.3	4.2	4.2
50	*	10.5	6.8	6.2	6.0
55	*	9.5	6.4	6.2	6.0

\* The ECM is a variable horsepower motor. Refer to Selectworks schedule for actual power consumption. FLA = Full load amperage. All motors are single phase/60 Hz.

NOTES:

- The ECM is pressure independent and constant volume in operation at factory or field set point within the shaded area. When the setpoint is on or below the respective maximum curve, airflow does not vary with changing static pressure conditions. The motor compensates for any changes in external static pressure or induced air conditions such as filter loading.

- Fan curves shown are applicable to 120, 208, 240 and 277 volt, single phase ECM's. ECM's, although DC in operation, include a built-in AC/DC converter.
- Minimum operation within the dark shaded area is not predictable.



Performance Data • NC Level Application Guide

Model Series 33SZ • Series Flow • FPCWTU (DOAS)

Unit Size	Inlet Size	Primary Airflow		Fan Airflow		Min. inlet ΔPs		Fan and 100% Primary Air-Sound Power Octave Bands @ Inlet pressure (ΔPs) shown										
		cfm	l/s	cfm	l/s	"w.g.	Pa	DISCHARGE					RADIATED					
								Fan Only	Minimum ΔPs	0.5" w.g. (125Pa)	1.0" w.g. (250Pa)	1.5" w.g. (375Pa)	Fan Only	Minimum ΔPs	0.5" w.g. (125Pa)	1.0" w.g. (250Pa)	1.5" w.g. (375Pa)	
10	4	225	106	500	236	0.20	50	21	21	25	30	32	30	36	40	44	47	
		150	71	400	189	0.07	17	-	-	23	28	30	27	33	38	42	45	
		150	71	300	142	0.05	12	-	-	24	29	31	23	31	36	39	42	
		90	42	200	95	0.03	7	-	-	20	25	27	-	27	33	36	38	
		90	42	100	47	0.02	5	-	-	-	-	20	-	-	28	31	33	
	6	500	236	500	236	0.20	50	21	24	28	32	35	30	33	37	42	45	
		350	165	400	189	0.07	17	-	20	26	30	33	27	31	35	39	42	
		200	95	300	142	0.05	12	-	20	27	31	34	23	28	33	37	39	
		150	71	200	95	0.03	7	-	-	23	27	30	-	25	30	34	36	
		30	14	100	47	0.02	5	-	-	-	20	23	-	-	26	29	31	
30	4	225	106	1250	590	0.42	104	38	37	37	38	38	43	40	40	41	41	
		150	71	1000	472	0.15	37	34	31	31	31	33	38	37	37	37	37	
		150	71	800	378	0.20	50	26	28	26	28	28	35	34	34	34	34	
		90	42	500	236	0.06	15	-	-	-	-	-	26	26	26	26	26	28
		90	42	250	118	0.10	25	-	-	-	-	-	22	23	23	23	23	24
	6	550	260	1250	590	0.12	30	38	37	37	37	38	43	40	40	41	41	
		400	189	1000	472	0.06	15	34	31	30	30	31	38	37	37	37	37	
		400	189	800	378	0.10	25	26	26	25	25	26	35	33	34	34	35	
		235	111	500	236	0.03	6	-	-	-	-	-	26	26	28	30	32	
		190	90	250	118	0.03	7	-	-	-	-	-	22	23	23	25	28	
	8	1100	519	1250	590	0.09	22	38	37	37	37	37	43	41	41	41	43	
		700	330	1000	472	0.01	2	34	31	30	30	30	38	37	37	37	38	
		415	196	800	378	0.01	2	26	26	25	25	25	35	33	34	34	35	
		250	118	500	236	0.01	2	-	-	-	-	-	26	26	26	28	29	
		190	90	250	118	0.01	2	-	-	-	-	-	23	22	23	24	26	
35	4	225	106	2000	945	0.97	241	45	42	42	42	42	47	46	46	45	46	
		150	71	1600	756	0.40	99	40	38	38	38	38	42	40	41	41	41	
		150	71	1200	567	0.37	93	34	32	32	32	32	37	37	37	37	38	
		90	43	800	378	0.12	31	26	24	24	24	24	32	32	32	33	33	
		90	43	400	189	0.12	29	-	-	-	-	-	23	24	24	25	25	
	5	400	189	2000	945	0.37	91	41	39	39	39	39	47	43	44	44	44	
		300	142	1600	756	0.17	42	40	38	38	38	38	42	38	39	39	39	
		200	95	1200	567	0.06	16	34	32	32	32	32	37	35	35	35	35	
		150	71	800	378	0.03	8	26	24	24	24	24	32	29	30	31	31	
		100	47	400	189	0.01	3	-	-	-	-	-	23	22	22	22	23	
	6	550	945	2000	945	0.25	63	41	39	39	39	39	47	47	48	48	48	
		400	756	1600	756	0.11	27	36	34	34	34	34	42	42	43	43	43	
		400	567	1200	567	0.09	22	31	28	28	28	28	37	38	38	38	38	
		235	378	800	378	0.03	6	26	24	24	24	24	32	33	33	33	33	
		235	189	400	189	0.02	5	-	-	-	-	-	23	25	25	25	25	
8	1100	520	2000	945	0.02	6	38	36	36	36	36	47	41	44	45	45		
	700	331	1600	756	0.01	2	36	34	34	34	34	42	38	41	41	41		
	700	331	1200	567	0.01	2	31	28	28	29	29	37	35	36	37	37		
	415	196	800	378	0.00	1	22	20	20	20	20	32	30	32	32	32		
	250	118	400	189	0.00	0	-	-	-	-	-	23	22	24	24	24		
10	1840	870	2000	945	0.54	135	38	36	36	36	36	47	47	47	47	48		
	1100	520	1600	756	0.19	48	34	32	32	32	32	42	41	42	43	43		
	660	312	1200	567	0.07	17	31	28	28	29	29	37	37	37	37	37		
	410	194	800	378	0.03	7	22	20	20	20	20	32	31	32	32	33		
	375	177	400	189	0.02	6	-	-	-	-	-	23	24	24	24	24		
40	4	225	106	1500	708	0.56	139	31	35	-	36	36	44	43	-	43	44	
		150	71	1200	566	0.21	52	27	26	28	28	28	39	40	41	41	41	
		150	71	900	425	0.26	65	-	21	23	24	24	33	34	35	35	36	
		90	42	600	283	0.08	20	-	-	-	-	-	31	33	34	33	32	
		90	42	300	142	0.10	25	-	-	-	-	-	26	30	30	30	31	
	6	550	260	1500	708	0.31	77	31	31	33	34	35	44	41	41	43	44	
		400	189	1200	566	0.07	17	27	26	27	27	26	39	38	38	39	39	
		400	189	900	425	0.09	22	-	20	21	21	23	33	32	33	34	35	
		235	111	600	283	0.03	7	-	-	-	-	20	31	29	29	29	29	
		145	68	300	142	0.02	5	-	-	-	-	-	26	24	25	25	26	
	8	1100	519	1500	708	0.09	22	31	33	33	33	34	43	43	44	44	44	
		700	330	1200	566	0.02	5	27	27	28	29	30	38	38	38	39	40	
		415	196	900	425	0.01	2	20	21	21	23	24	34	33	34	34	35	
		290	137	600	283	0.01	2	-	-	-	-	-	29	28	29	30	31	
		175	83	300	142	0.01	2	-	-	-	-	-	25	25	25	25	26	
10	1400	661	1500	708	0.02	5	32	31	33	34	34	43	41	43	44	45		
	660	311	1200	566	0.01	2	30	29	30	30	30	38	37	38	38	39		
	445	210	900	425	0.01	2	20	22	21	22	23	33	32	33	34	34		
	335	158	600	283	0.01	2	-	-	-	20	21	29	29	29	29	29		
	260	123	300	142	0.01	2	-	-	-	-	-	24	24	24	25	28		

Performance Notes: 1. NC Levels are calculated based on procedures as outlined on page C160.

2. Dash (-) in space indicates a NC less than 20.

Performance Data • NC Level Application Guide

Model Series 33SZ • Series Flow • FPCWTU (DOAS)

Unit Size	Inlet Size	Primary Airflow		Fan Airflow		Min. inlet ΔPs		Fan and 100% Primary Air–Sound Power Octave Bands @ Inlet pressure (ΔPs) shown									
		cfm	l/s	cfm	l/s	"w.g.	Pa	DISCHARGE					RADIATED				
								Fan Only	Minimum ΔPs	0.5" w.g. (125Pa)	1.0" w.g. (250Pa)	1.5" w.g. (375Pa)	Fan Only	Minimum ΔPs	0.5" w.g. (125Pa)	1.0" w.g. (250Pa)	1.5" w.g. (375Pa)
50	4	225	106	2000	944	0.51	127	36	39	-	38	38	40	42	-	42	43
		150	71	1600	755	0.18	45	31	31	33	34	34	36	36	36	37	38
		150	71	1200	566	0.24	60	26	26	27	27	27	31	32	31	32	33
		90	42	800	378	0.08	20	22	22	23	24	24	25	25	24	25	27
		90	42	500	236	0.10	25	-	20	-	-	-	23	23	23	24	25
	6	550	260	2000	944	0.12	30	35	36	35	36	36	40	41	42	42	43
		400	189	1600	755	0.04	10	30	29	30	31	32	36	36	36	38	39
		400	189	1200	566	0.09	22	24	24	24	25	25	30	32	32	33	35
		235	111	800	378	0.02	5	22	24	26	28	29	25	25	25	27	29
		235	111	500	236	0.04	10	-	-	-	-	-	22	23	24	26	28
	8	1100	519	2000	944	0.12	30	34	33	34	34	35	40	42	43	43	43
		700	330	1600	755	0.02	5	30	28	29	31	32	36	36	37	39	40
		700	330	1200	566	0.06	15	30	28	28	29	30	31	32	33	35	37
		415	196	800	378	0.01	2	-	-	-	-	-	25	25	26	29	32
		250	118	500	236	0.01	2	-	-	-	-	20	23	23	24	26	28
	10	1840	868	2000	944	0.25	62	34	34	34	35	36	41	42	44	45	46
		1100	519	1600	755	0.08	20	28	27	28	29	31	36	36	37	39	40
		660	311	1200	566	0.01	2	23	22	23	24	25	31	31	31	33	35
		410	193	800	378	0.01	2	-	-	-	-	-	25	25	26	27	29
		375	177	500	236	0.01	2	-	-	-	-	-	23	22	24	26	28
12	2000	944	2000	944	0.09	22	33	34	34	35	37	40	41	43	44	46	
	1600	755	1600	755	0.06	15	28	26	28	32	36	36	36	38	41	43	
	595	281	1200	566	0.01	2	22	21	22	23	25	31	31	31	32	34	
	445	210	800	378	0.01	2	-	-	-	-	-	25	25	25	27	30	
	395	186	500	236	0.01	2	-	-	-	-	-	22	22	24	27	29	
55	6	550	260	2000	944	0.01	2	37	37	37	37	38	41	47	46	47	48
		400	189	1600	755	0.00	1	33	31	33	33	34	38	41	44	45	45
		400	189	1200	566	0.01	2	28	29	29	30	30	34	40	40	41	41
		235	111	800	378	0.00	1	23	24	26	26	27	28	33	35	36	37
		235	111	500	236	0.01	2	-	-	-	20	21	22	30	30	31	31
	8	1100	520	2000	944	0.03	7	36	37	37	38	38	41	42	44	45	45
		700	331	1600	755	0.02	4	33	32	33	34	34	38	37	41	42	42
		700	331	1200	566	0.02	5	28	30	30	31	31	34	36	38	39	40
		415	196	800	378	0.01	3	20	21	23	23	23	28	29	33	34	35
		250	118	500	236	0.01	2	-	-	-	-	-	22	23	28	29	29
	10	1840	870	2000	944	0.08	19	36	38	38	39	39	41	43	44	45	45
		1100	520	1600	755	0.04	9	32	30	33	33	33	38	35	40	41	41
		660	312	1200	566	0.02	5	28	27	27	28	28	34	35	36	37	37
		410	194	800	378	0.01	3	20	-	20	21	21	28	26	31	32	32
		375	177	500	236	0.02	4	-	-	-	-	-	22	26	27	28	29
	12	2000	945	2000	944	0.09	22	36	36	36	37	37	41	32	42	43	43
		1600	756	1600	755	0.08	20	32	32	32	33	33	38	26	39	40	41
		900	425	1200	566	0.06	14	-	-	21	22	22	34	22	35	36	36
		445	210	800	378	0.02	6	-	-	-	-	-	28	20	29	30	31
		395	187	500	236	0.01	2	26	-	21	21	22	22	-	25	26	27
14	2000	945	2000	944	0.09	22	36	34	34	34	35	41	37	40	41	41	
	1600	756	1600	755	0.08	20	32	30	30	31	31	38	32	37	38	39	
	900	425	1200	566	0.06	14	-	-	-	-	-	34	30	33	34	34	
	445	210	800	378	0.02	6	-	-	-	-	-	28	22	27	28	28	
	395	187	500	236	0.01	2	26	-	-	-	-	22	21	23	24	25	

For full performance table notes, see page C35.

FAN POWERED TERMINAL UNITS



Performance Data • Discharge Sound Power Levels

Model Series 33SZ • Series Flow • FPCWTU (DOAS)

Unit Size	Inlet Size	Primary Airflow		Fan Airflow		Min. inlet ΔPs "w.g. Pa	Fan and 100% Primary Air-Sound Power Octave Bands @ Inlet pressure (ΔPs) shown																														
							Fan Only						Minimum ΔPs						0.5" w.g. Inlet Static					1.0" w.g. Inlet Static					1.5" w.g. Inlet Static								
							2	3	4	5	6	7	2	3	4	5	6	7	2	3	4	5	6	7	2	3	4	5	6	7	2	3	4	5	6	7	
10	4	225	106	500	236	0.20	50	68	62	59	53	43	33	68	63	59	52	42	32	71	66	62	55	45	36	75	70	64	58	48	40	77	72	66	60	50	42
		150	71	400	189	0.07	17	65	58	55	49	39	27	65	60	56	49	39	29	70	65	60	55	45	36	73	68	63	58	48	39	75	70	65	60	50	42
		150	71	300	142	0.05	12	59	53	50	44	34	22	62	57	54	48	38	29	67	62	58	55	46	36	71	65	61	58	49	40	73	67	63	59	50	42
		90	42	200	95	0.03	7	55	49	47	42	31	14	59	54	51	44	34	25	64	59	56	52	43	34	68	62	59	55	46	37	70	64	60	57	47	39
		90	42	100	47	0.02	5	50	46	43	38	26	13	53	47	46	44	36	26	59	53	52	53	46	36	62	56	55	56	49	40	64	58	56	58	51	42
	6	500	236	500	236	0.20	50	68	62	59	53	43	33	70	65	61	54	44	34	73	68	64	57	47	38	77	72	66	60	50	42	79	74	68	62	52	44
		350	165	400	189	0.07	17	65	58	55	49	39	27	67	62	58	51	41	31	72	67	62	57	47	38	75	70	65	60	50	41	77	72	67	62	52	44
		200	95	300	142	0.05	12	59	53	50	44	34	22	64	59	56	50	40	31	69	64	60	57	48	38	73	67	63	60	51	42	75	69	65	61	52	44
		150	71	200	95	0.03	7	55	49	47	42	31	14	61	56	53	46	36	27	66	61	58	54	45	36	70	64	61	57	48	39	72	66	62	59	49	41
		30	14	100	47	0.02	5	50	46	43	38	26	13	55	49	48	46	38	28	61	55	54	55	48	38	64	58	57	58	51	42	66	60	58	60	53	44
30	4	225	106	1250	590	0.42	104	79	78	71	72	71	69	80	77	72	72	71	69	79	77	71	72	71	69	78	78	71	72	71	69	78	78	71	72	71	69
		150	71	1000	472	0.15	37	77	74	67	69	67	65	76	72	66	67	66	64	75	72	66	67	65	63	76	72	66	67	66	64	76	73	67	68	66	64
		150	71	800	378	0.20	50	74	68	63	64	62	60	74	69	63	63	62	60	74	68	63	64	62	60	73	69	63	64	62	60	73	69	63	64	62	60
		90	42	500	236	0.06	15	64	57	55	55	52	48	65	58	55	55	52	49	64	58	55	55	51	48	64	57	55	55	51	47	63	57	55	55	51	47
		90	42	250	118	0.10	25	58	51	51	49	46	39	59	51	52	50	46	38	59	51	50	48	44	36	58	51	50	48	44	36	57	51	50	47	43	36
	6	550	260	1250	590	0.12	30	79	78	71	72	71	69	80	77	72	72	71	69	79	77	71	72	71	69	79	77	71	72	71	69	79	78	71	72	71	69
		400	189	1000	472	0.06	15	77	74	67	69	67	65	76	72	66	67	66	64	75	71	66	67	65	63	75	71	66	67	65	63	75	72	66	67	66	64
		400	189	800	378	0.10	25	74	68	63	64	62	60	73	68	62	63	61	59	73	67	62	63	61	59	73	67	62	63	61	59	72	68	62	63	61	59
		235	111	500	236	0.03	6	64	57	55	55	52	48	65	58	55	55	52	48	64	58	55	55	51	47	65	58	55	55	51	47	65	58	55	55	51	47
		190	90	250	118	0.03	7	58	51	51	49	46	39	58	51	52	50	46	38	60	52	50	48	45	37	60	54	51	49	45	38	61	55	51	49	46	39
8	1100	519	1250	590	0.09	22	79	78	71	72	71	69	80	77	72	72	71	69	79	77	71	72	71	69	79	77	71	72	71	69	79	77	71	72	71	69	
	700	330	1000	472	0.01	2	77	74	67	69	67	65	76	72	66	67	66	64	75	71	66	67	65	63	75	71	66	67	65	63	75	71	66	67	65	63	
	415	196	800	378	0.01	2	74	68	63	64	62	60	73	68	62	63	61	59	73	67	62	63	61	59	73	67	62	63	61	59	72	67	62	63	61	59	
	250	118	500	236	0.01	2	65	57	55	55	52	48	66	57	55	55	52	48	65	57	55	55	51	47	65	57	55	55	51	47	65	57	55	55	51	47	
	190	90	250	118	0.01	2	58	51	51	49	46	39	58	50	51	49	45	37	59	51	50	48	44	36	59	52	50	49	45	37	59	53	51	49	45	38	
35	4	225	83	2000	945	0.97	241	83	75	71	70	68	67	82	75	71	70	69	67	82	75	71	70	69	67	82	75	71	70	69	67	82	75	71	70	69	67
		150	31	1600	945	0.40	99	80	72	68	67	65	63	78	71	68	67	65	62	78	72	68	67	65	62	78	72	68	67	65	62	78	72	68	67	65	62
		150	83	1200	709	0.37	93	75	67	65	63	61	57	74	67	64	62	60	56	74	67	64	62	60	56	74	67	64	62	60	56	74	67	64	62	60	55
		90	31	800	709	0.12	31	69	60	60	57	55	50	67	61	59	56	53	47	67	61	59	56	53	47	67	61	59	56	53	47	67	61	59	56	53	47
		90	83	400	520	0.12	29	58	49	52	48	44	37	56	49	49	44	40	32	56	50	50	44	40	31	57	50	50	44	40	31	57	50	50	44	40	31
	5	400	189	2000	945	0.37	91	83	75	71	70	68	67	82	74	70	70	68	66	82	74	70	70	68	66	82	74	70	70	68	66	82	74	70	70	68	66
		300	142	1600	756	0.17	42	80	72	68	67	65	63	78	71	68	66	64	62	78	71	68	66	64	62	78	71	68	66	64	61	78	71	68	66	64	61
		200	95	1200	567	0.06	16	75	67	65	63	61	57	74	67	64	62	60	55	74	67	64	62	60	55	74	67	64	62	60	55	74	67	64	62	60	55
		150	71	800	378	0.03	8	69	60	60	57	55	50	67	60	59	55	52	47	67	60	59	55	52	47	67	61	59	55	52	47	67	61	59	55	52	46
		100	47	400	189	0.01	3	58	49	52	48	44	37	56	50	49	44	40	31	56	50	49	44	40	31	57	50	49	44	40	31	57	50	49	44	40	31
6	550	945	2000	945	0.25	63	83	75	71	70	68	67	82	74	70	70	68	66	82	74	70	70	68	66	82	74	70	70	68	66	82	74	70	70	68	66	
	400	756	1600	756	0.11	27	80	72	68	67	65	63	78	70	67	66	64	61	78	70	67	66	64	61	78	71	67	66	64	61	78	71	67	66	64	61	
	400	567	1200	567	0.09	22	75	67	65	63	61	57	74	66	63	61	59	55	74	66	63	61	59	55	74	66	63	61	59	55	74	66	63	61	59	55	
	235	378	800	378	0.03	6	69	60	60	57	55	50	67	60	58	55	52	46	67	60	58	55	52	46	67	60	58	55	52	46	67	60	58	55	52	46	
	235	189	400	189	0.02	5	58	49	52	48	44	37	57	49	49	43	39	31	57	49	49	43	39	31	57	49	49	43	39	31	57	49	49	43	39	31	
8	1100	520	2000	945	0.02	6	83	75	71	70	68	67	82	73	69	69	67	66	82	73	69	69	67	66	82	73	69	69	67	66	82	73	69	69	67	66	
	700	331	1600	756	0.01	2	80	72	68	67	65	63	78	70	67	66	63	61	78	70	67	66	63	61	78	70	67	66	63	61	78	70	67	66	63	61	
	415	196	800	378	0.01	2	75	67	65	63	61	57	74	65	63	61	58	55	74	65	63	61	58	55	74												

Performance Data • Discharge Sound Power Levels

Model Series 33SZ • Series Flow • FPCWTU (DOAS)

Unit Size	Inlet Size	Primary Airflow		Fan Airflow		Min. inlet ΔPs "w.g. Pa	Fan and 100% Primary Air-Sound Power Octave Bands @ Inlet pressure (ΔPs) shown																																		
							Fan Only					Minimum ΔPs					0.5" w.g. Inlet Static					1.0" w.g. Inlet Static					1.5" w.g. Inlet Static														
							2	3	4	5	6	7	2	3	4	5	6	7	2	3	4	5	6	7	2	3	4	5	6	7	2	3	4	5	6	7					
50	4	225	106	2000	944	0.51	127	77	74	72	74	71	70	79	75	72	75	71	71	-	-	-	-	-	-	78	75	72	75	71	71	78	76	72	75	71	71				
		150	71	1600	755	0.18	45	72	70	68	68	66	64	73	69	69	68	65	64	74	70	69	69	66	65	75	71	69	69	66	66	75	72	69	70	66	67				
		150	71	1200	566	0.24	60	69	64	63	62	59	57	69	65	62	62	59	58	69	65	63	62	59	59	69	65	63	63	59	59	69	65	63	63	60	59				
		90	42	800	378	0.08	20	66	58	56	55	51	47	66	59	57	56	52	48	67	60	58	56	52	49	67	59	58	56	52	48	67	59	58	55	52	48				
		90	42	500	236	0.10	25	64	58	55	52	47	41	64	57	53	51	46	39	63	57	55	52	46	40	62	56	55	53	46	40	62	55	55	53	45	40				
	6	550	260	2000	944	0.12	30	77	74	72	74	71	70	80	75	72	74	71	71	79	75	72	74	71	71	79	75	72	75	71	71	78	76	72	75	71	71				
		400	189	1600	755	0.04	10	72	70	68	68	65	64	73	70	68	68	65	64	75	70	69	69	66	65	75	71	69	69	66	66	76	72	69	70	66	67				
		400	189	1200	566	0.09	22	69	65	63	62	59	57	69	65	63	62	59	59	70	65	63	63	60	59	70	66	63	63	60	60	70	66	64	63	60	60				
		235	111	800	378	0.02	5	66	60	58	56	52	49	67	62	59	58	54	51	69	63	61	59	55	53	70	64	61	59	56	53	71	65	62	59	57	54				
		235	111	500	236	0.04	10	62	57	55	51	47	41	61	55	52	50	45	38	61	56	54	52	46	40	61	56	55	52	46	40	62	57	55	52	46	41				
	8	1100	519	2000	944	0.12	30	77	74	72	74	71	70	78	73	72	73	70	70	78	74	72	74	70	70	78	75	72	74	71	71	78	76	72	75	71	71				
		700	330	1600	755	0.02	5	73	70	68	68	66	64	72	68	67	67	64	63	74	70	68	68	65	64	75	71	69	69	66	65	75	72	69	69	66	66				
		700	330	1200	566	0.06	15	74	70	66	66	63	60	71	68	64	64	61	60	72	69	65	65	62	60	72	69	65	65	62	61	72	70	66	65	62	61				
		415	196	800	378	0.01	2	65	59	57	55	52	50	64	58	57	55	52	49	65	59	58	56	53	50	65	59	58	55	52	50	66	59	58	55	52	49				
		250	118	500	236	0.01	2	64	59	56	53	49	45	63	58	54	52	48	43	63	58	56	54	49	44	64	58	56	54	49	44	64	58	56	54	49	44				
	10	1840	868	2000	944	0.25	62	77	75	72	74	71	71	78	74	72	73	70	71	79	74	72	73	71	71	80	75	72	74	71	71	81	76	73	74	71	71				
		1100	519	1600	755	0.08	20	73	70	68	68	65	65	72	68	67	67	64	64	74	69	68	67	65	65	75	71	68	68	66	65	75	72	69	69	66	66				
		660	311	1200	566	0.01	2	69	64	62	61	58	57	68	63	61	61	58	56	69	64	62	61	59	57	70	65	62	62	59	58	71	66	63	62	59	58				
		410	193	800	378	0.01	2	65	58	56	55	51	46	64	58	55	54	50	45	65	59	57	55	51	47	66	60	57	55	51	47	66	60	57	55	51	47				
		375	177	500	236	0.01	2	64	58	55	52	47	41	62	56	53	50	45	39	62	57	55	52	46	41	63	58	55	52	47	41	64	58	55	52	47	42				
12	2000	944	2000	944	0.09	22	77	74	72	74	71	70	78	73	72	73	70	71	78	74	72	74	71	71	80	76	72	74	71	71	81	77	73	75	71	71					
	1600	755	1600	755	0.06	15	73	70	68	68	65	64	71	67	67	67	64	63	75	70	69	68	66	65	77	73	70	70	67	67	80	76	72	72	68	69					
	900	425	1200	566	0.01	2	69	64	63	61	58	57	67	63	61	61	58	56	69	64	63	62	59	58	70	66	64	63	60	60	72	67	65	64	61	61					
	445	210	800	378	0.01	2	64	58	56	55	51	47	63	58	56	55	51	46	65	59	58	56	52	49	66	59	57	56	52	48	66	59	57	55	51	47					
	395	186	500	236	0.01	2	63	57	55	51	46	41	63	56	53	50	45	39	62	56	54	52	47	41	61	56	54	53	48	41	61	55	54	53	49	42					
55	6	550	260	2000	944	0.01	2	80	77	74	73	70	70	80	76	75	72	71	72	80	76	75	72	71	72	81	76	75	73	71	73	81	76	75	73	71	73				
		400	189	1600	755	0.00	1	76	73	70	69	66	65	76	71	71	68	66	67	77	72	72	68	66	67	77	73	72	68	67	68	78	73	72	68	67	68				
		400	189	1200	566	0.01	2	72	69	66	63	60	57	74	70	68	64	62	61	74	70	68	64	62	61	75	70	68	64	62	61	75	70	68	64	62	61				
		235	111	800	378	0.00	1	67	62	59	56	51	47	68	62	61	56	53	51	69	63	61	56	54	51	69	63	62	56	54	51	69	64	62	56	54	52				
		235	111	500	236	0.01	2	60	55	52	47	42	35	64	59	55	50	46	40	64	59	55	50	46	40	65	59	55	50	46	40	65	59	55	50	46	40				
	8	1100	520	2000	944	0.03	7	80	77	74	73	70	70	81	78	74	73	70	70	80	77	74	73	70	70	81	78	74	73	71	70	81	78	74	73	71	70				
		700	331	1600	755	0.02	4	76	73	70	69	66	65	76	72	70	68	65	64	77	73	70	68	66	65	77	73	70	68	66	65	77	74	70	68	66	65				
		700	331	1200	566	0.02	5	72	69	66	63	60	57	74	70	66	64	61	58	74	70	66	64	61	58	74	71	66	64	61	58	75	71	66	64	61	58				
		415	196	800	378	0.01	3	67	62	59	56	51	47	67	63	59	56	52	48	68	64	60	56	53	49	69	64	60	57	53	49	69	65	60	57	53	49				
		250	118	500	236	0.01	2	60	55	52	47	42	35	62	57	53	48	44	38	62	57	53	48	44	38	63	57	53	48	44	38	63	58	53	48	44	38				
	10	1840	870	2000	944	0.08	19	80	77	74	73	70	70	80	78	72	73	69	67	80	78	72	73	69	67	81	79	72	73	70	68	81	79	72	73	70	68				
		1100	520	1600	755	0.04	9	76	73	70	69	66	65	74	71	68	67	64	62	76	73	69	68	65	63	77	74	69	68	65	63	77	74	69	68	65	63				
		660	312	1200	566	0.02	5	72	69	66	63	60	57	71	68	64	62	58	56	72	68	64	62	59	56	72	69	64	62	59	56	73	69	64	62	59	56				
		410	194	800	378	0.01	3	67	62	59	56	51	47	64	60	57	54	50	46	66	62	58	54	51	47	67	62	58	55	51	47	67	63	58	55	51	47				
		375	177	500	236	0.02	4	60	55	52	47	42	35	61	57	51	47	42	35	62	57	51	47	43	36	62	58	51	48	43	36	62	58	51	48	43	36				
	12	2000	945	2000	944	0.09	22	80	77	74	73	70	70	78	76	70	71	67	65	78	77	70	72	68	65	79	77	70	72	68	66	79	77	70	72	68	66				
		1600	756	1600	755	0.08	20	76	73	70	69	66	65	75	73	67	67	63	60	76	73	67	68	63	60	76	74	67	68	64	60	76	74	67	68	64	61				
		900	425	1200	566	0.06	14	67	62	59	56	51	47	66	63	56	55	50	43	67	64	56	56	50	44	67	64	57	56	51	44	68	65	57	56	51	44				
		445	210	800	378	0.02	6	60	55	52	47	42	35	58	54	48	45	40	32	60	56	49	46	41	34	61	56	49	46												

Performance Data • Radiated Sound Power Levels

Model Series 33SZ • Series Flow • FPCWTU (DOAS)

Unit Size	Inlet Size	Primary Airflow		Fan Airflow		Min. inlet ΔPs "w.g. Pa	Fan and 100% Primary Air—Sound Power Octave Bands @ Inlet pressure (ΔPs) shown																																		
							Fan Only							Minimum ΔPs							0.5" w.g. Inlet Static							1.0" w.g. Inlet Static							1.5" w.g. Inlet Static						
							2	3	4	5	6	7	2	3	4	5	6	7	2	3	4	5	6	7	2	3	4	5	6	7	2	3	4	5	6	7					
10	4	225	106	500	236	0.20	50	66	58	56	51	46	42	70	65	61	53	43	34	73	69	64	58	48	38	77	72	67	61	51	43	79	74	69	63	53	45				
		150	71	400	189	0.07	17	63	55	53	48	42	35	68	63	59	52	41	32	72	67	62	57	47	38	75	70	65	61	51	42	77	72	67	63	53	45				
		150	71	300	142	0.05	12	59	50	49	43	37	27	65	59	56	50	39	30	69	64	61	57	48	39	73	67	64	60	51	43	75	70	65	62	54	45				
		90	42	200	95	0.03	7	53	44	43	37	30	16	61	56	53	46	35	26	66	61	58	54	45	36	70	64	61	58	49	40	72	66	63	60	51	42				
		90	42	100	47	0.02	5	44	33	34	26	18	-3	54	47	46	41	30	21	60	54	53	55	48	38	64	58	56	58	52	43	66	60	58	60	54	45				
	6	500	236	500	236	0.20	50	66	58	56	51	46	42	68	63	59	51	41	32	71	67	62	56	46	36	75	70	65	59	49	41	77	72	67	61	51	43				
		350	165	400	189	0.07	17	63	55	53	48	42	35	66	61	57	50	39	30	70	65	60	55	45	36	73	68	63	59	49	40	75	70	65	61	51	43				
		200	95	300	142	0.05	12	59	50	49	43	37	27	63	57	54	48	37	28	67	62	59	55	46	37	71	65	62	58	49	41	73	68	63	60	52	43				
		150	71	200	95	0.03	7	53	44	43	37	30	16	59	54	51	44	33	24	64	59	56	52	43	34	68	62	59	56	47	38	70	64	61	58	49	40				
		30	14	100	47	0.02	5	44	33	34	26	18	-3	52	45	44	39	28	19	58	52	51	53	46	36	62	56	54	56	50	41	64	58	56	58	52	43				
	30	4	225	106	1250	590	0.42	104	71	70	67	67	61	53	70	68	65	66	59	49	70	68	65	66	59	51	71	68	66	66	59	53	72	69	66	66	59	55			
			150	71	1000	472	0.15	37	68	65	63	63	56	46	67	64	62	63	55	46	67	64	62	62	54	47	68	64	62	62	55	48	69	65	62	62	55	49			
150			71	800	378	0.20	50	66	61	60	60	51	41	65	61	59	59	50	40	65	60	59	59	50	42	66	61	59	59	51	43	67	61	59	59	51	45				
90			42	500	236	0.06	15	57	51	52	51	40	28	59	52	52	51	40	30	59	52	52	50	40	35	59	53	52	50	41	36	59	54	53	50	41	38				
90			42	250	118	0.10	25	49	48	48	44	33	17	47	48	49	44	34	25	50	49	49	45	36	34	49	49	49	45	37	35	48	49	50	46	38	37				
6		550	260	1250	590	0.12	30	71	70	67	67	61	53	70	68	65	66	59	50	69	68	65	66	59	52	70	68	66	66	59	55	70	68	66	66	59	58				
		400	189	1000	472	0.06	15	68	65	63	63	56	46	67	64	62	63	55	46	67	64	62	62	55	48	67	64	62	62	55	50	67	64	62	62	55	52				
		400	189	800	378	0.10	25	66	61	60	60	51	41	62	59	58	58	50	39	63	59	59	59	50	44	64	61	59	59	52	49	66	62	60	60	54	54				
		235	111	500	236	0.03	6	57	51	52	51	40	28	57	52	52	51	40	30	60	54	53	52	43	40	62	57	55	54	47	46	64	60	57	56	51	53				
		190	90	250	118	0.03	7	49	48	48	44	33	17	48	48	49	44	34	21	53	50	49	46	38	34	53	51	51	48	41	39	54	53	53	49	45	44				
8		1100	519	1250	590	0.09	22	73	70	67	67	61	53	71	68	66	66	59	50	71	68	66	66	59	53	71	69	66	66	59	56	72	69	67	66	60	59				
		700	330	1000	472	0.01	2	70	66	63	63	56	46	67	63	62	62	54	45	67	63	62	62	54	49	68	64	62	62	55	53	69	65	63	63	56	57				
	415	196	800	378	0.01	2	67	61	60	59	51	40	64	59	58	58	49	39	64	60	59	58	50	44	65	61	59	59	52	48	67	62	60	59	53	53					
	250	118	500	236	0.01	2	56	51	52	50	40	28	57	52	52	50	40	30	58	52	52	51	42	38	59	54	53	51	45	43	60	56	54	52	48	47					
	190	90	250	118	0.01	2	48	48	49	44	33	18	47	48	48	43	32	52	49	49	45	38	34	53	51	50	47	41	39	54	52	52	48	45	43						
35	4	225	106	2000	945	0.97	241	79	71	69	68	60	50	78	70	68	67	59	49	78	70	68	67	59	49	78	70	68	67	59	50	78	70	68	67	59	51				
		150	71	1600	756	0.40	99	75	68	66	64	56	45	74	67	65	64	55	42	74	67	65	64	55	45	74	67	65	64	55	46	75	67	66	64	55	47				
		150	71	1200	567	0.37	93	70	63	62	60	51	39	70	63	62	59	51	41	70	63	62	59	51	41	69	63	62	60	51	42	70	63	62	60	51	43				
		90	43	800	378	0.12	31	63	57	57	53	43	31	63	57	57	53	44	31	63	58	58	54	44	34	62	58	58	54	44	35	63	58	58	54	44	36				
		90	43	400	189	0.12	29	51	46	49	42	30	16	52	48	50	44	33	24	52	48	50	44	33	24	51	48	50	44	33	25	52	49	51	44	33	26				
	5	400	189	2000	945	0.37	91	79	71	69	68	60	50	76	68	65	65	57	46	76	68	66	65	57	48	77	68	66	65	57	49	77	69	66	65	57	50				
		300	142	1600	756	0.17	42	75	68	66	64	56	45	72	64	62	61	53	39	73	65	63	62	53	44	73	65	63	62	53	45	73	65	64	62	53	46				
		200	95	1200	567	0.06	16	70	63	62	60	51	39	68	61	60	57	48	38	68	61	60	57	49	39	68	61	60	58	49	41	68	62	60	58	49	41				
		150	71	800	378	0.03	8	63	57	57	53	43	31	61	55	55	51	42	28	61	56	56	52	42	33	61	56	56	52	42	34	61	56	56	52	42	35				
		100	47	400	189	0.01	3	51	46	49	42	30	16	50	46	48	41	31	20	50	46	48	42	31	22	50	46	48	42	31	24	50	47	49	42	31	24				
	6	550	945	2000	945	0.25	63	79	71	69	68	60	50	80	73	69	68	61	55	80	73	69	68	61	56	80	73	69	68	61	56	80	73	69	68	60	56				
		400	756	1600	756	0.11	27	75	68	66	64	56	45	75	70	66	65	57	49	76	69	66	65	57	51	76	69	66	65	57	52	76	69	66	65	57	52				
400		567	1200	567	0.09	22	70	63	62	60	51	39	71	65	63	61	52	47	71	65	63	60	52	47	71	65	63	60	52	48	71	65	63	60	52	48					
235		378	800	378	0.03	6	63	57	57	53	43	31	64	60	58	54	45	37	65	59	58	54	45	39	65	59	58	54	45	40	65	59	58	54	45	40					
235		189	400	189	0.02	5	51	46	49	42	30	16	53	50	50	44	33	29	53	50	50	44	33	30	54	50	50	44	33	30	54	50	50	44	33	31					
8	1100	520	2000	945	0.02	6	79	71	69	68	60	50	73	66	65	65	55	37	77	70	67	66	57	52	77	70	67	66	58	53	78	71	67	66	58	54					
	700	331	1600	756	0.01	2	75	68	66	64	56	45	69	62	63	61	51	29	74	68	65	63	54	49	74	68	65	63	55	50	75	68	65	63	55	51					
	700	331	1200	567	0.01	2	70	63	62	60	51	39	66	61	60	58	47	32	70	64	61	59	50	46	70	65															

Performance Data • Radiated Sound Power Levels

Model Series 33SZ • Series Flow • FPCWTU (DOAS)

Unit Size	Inlet Size	Primary Airflow		Fan Airflow		Min. inlet ΔPs "w.g. Pa	Fan and 100% Primary Air-Sound Power Octave Bands @ Inlet pressure (ΔPs) shown																														
							Fan Only					Minimum ΔPs					0.5" w.g. Inlet Static					1.0" w.g. Inlet Static					1.5" w.g. Inlet Static										
							2	3	4	5	6	7	2	3	4	5	6	7	2	3	4	5	6	7	2	3	4	5	6	7	2	3	4	5	6	7	
50	4	225	106	2000	944	0.51	127	70	68	65	66	65	62	73	69	66	66	65	62	-	-	-	-	-	-	73	70	66	66	65	63	73	71	66	65	65	63
		150	71	1600	755	0.18	45	66	64	61	60	59	56	66	63	61	60	59	56	67	64	61	60	59	56	68	65	62	61	60	57	69	67	63	62	60	58
		150	71	1200	566	0.24	60	63	60	56	54	53	49	62	58	57	55	53	50	63	59	57	55	53	49	63	59	57	55	54	50	64	60	58	56	56	51
		90	42	800	378	0.08	20	60	53	51	48	45	39	59	53	50	48	45	39	59	53	50	48	45	40	59	53	51	49	46	41	60	53	52	50	46	42
		90	42	500	236	0.10	25	60	52	49	45	41	34	58	51	49	45	40	34	58	50	49	45	43	38	57	50	50	46	44	40	56	51	51	47	45	42
	6	550	260	2000	944	0.12	30	70	68	65	66	65	62	73	69	66	66	64	62	72	70	67	66	65	64	72	70	67	66	65	64	72	71	66	65	66	65
		400	189	1600	755	0.04	10	67	64	61	60	59	56	66	63	61	60	59	56	67	64	61	60	60	57	68	66	62	61	61	59	68	67	63	63	62	61
		400	189	1200	566	0.09	22	62	59	56	54	53	49	62	59	58	55	53	50	63	59	58	56	55	52	64	61	59	57	57	55	65	62	60	58	59	59
		235	111	800	378	0.02	5	58	53	51	48	45	39	59	54	50	48	45	40	59	54	51	49	48	44	60	55	53	51	51	49	62	57	55	53	54	53
		235	111	500	236	0.04	10	59	52	48	45	40	33	57	52	49	46	40	35	59	52	50	47	46	43	59	54	52	49	50	48	59	56	54	51	54	53
	8	1100	519	2000	944	0.12	30	71	68	65	66	65	63	74	69	66	67	65	63	73	70	67	67	65	64	74	70	67	66	66	65	74	71	67	66	66	66
		700	330	1600	755	0.02	5	67	64	61	60	59	57	67	63	61	60	59	56	68	65	62	61	60	58	69	66	63	62	61	60	70	68	65	63	62	62
		700	330	1200	566	0.06	15	63	60	57	55	54	50	62	59	58	55	53	50	64	60	58	57	55	52	65	62	60	58	57	56	67	64	61	60	60	59
		415	196	800	378	0.01	2	59	53	51	48	45	39	58	53	50	49	45	39	60	55	52	50	48	45	62	58	54	53	52	50	65	60	57	55	56	55
		250	118	500	236	0.01	2	59	52	49	45	41	34	57	51	49	45	40	34	58	52	50	46	45	41	59	54	52	48	49	46	59	55	54	51	52	50
	10	1840	868	2000	944	0.25	62	70	69	65	65	65	63	73	70	67	66	65	63	73	70	68	67	66	64	74	71	69	67	66	65	75	72	70	68	67	67
		1100	519	1600	755	0.08	20	66	64	61	60	59	57	66	63	61	60	59	56	68	65	62	61	60	58	69	66	63	62	61	60	70	67	64	63	62	62
		660	311	1200	566	0.01	2	62	59	56	54	53	49	61	58	56	54	52	49	63	59	57	55	54	51	64	61	58	56	57	55	66	63	60	58	59	59
		410	193	800	378	0.01	2	60	53	51	48	45	38	60	52	50	47	44	38	60	54	51	49	49	45	61	56	53	51	52	49	62	58	55	53	56	54
		375	177	500	236	0.01	2	59	52	49	45	40	33	58	51	48	45	40	33	59	52	50	47	47	43	60	54	52	50	51	48	60	56	54	52	55	53
	12	2000	944	2000	944	0.09	22	69	69	64	66	65	63	72	69	66	66	64	63	73	70	68	67	65	64	74	72	69	67	66	65	75	73	70	67	67	66
		1600	755	1600	755	0.06	15	66	64	61	60	59	56	66	63	61	60	59	55	68	66	63	62	60	58	70	68	65	64	62	60	72	70	67	66	63	63
		900	425	1200	566	0.01	2	62	60	56	54	53	48	60	58	56	54	52	49	61	58	57	55	53	50	62	59	58	57	55	52	63	60	59	58	57	54
		445	210	800	378	0.01	2	59	54	51	48	45	38	57	53	50	47	44	38	58	54	51	50	48	43	59	55	53	54	51	47	61	57	55	57	55	51
395		186	500	236	0.01	2	58	52	48	45	40	32	57	52	48	45	40	32	59	52	50	49	46	40	59	54	52	53	50	45	60	55	54	57	55	50	
55	6	550	260	2000	944	0.01	2	72	70	65	63	62	58	76	74	68	65	64	62	76	74	68	65	63	62	76	75	68	66	65	64	77	75	69	66	66	65
		400	189	1600	755	0.00	1	69	67	62	59	58	53	72	70	63	60	57	53	74	72	65	62	61	59	74	73	66	63	63	61	75	73	66	64	64	63
		400	189	1200	566	0.01	2	67	63	59	55	53	48	71	69	63	60	59	57	71	69	63	60	59	56	72	70	64	60	61	59	72	70	64	61	62	60
		235	111	800	378	0.00	1	63	58	54	49	46	39	66	63	56	52	51	45	68	65	58	55	55	52	69	65	59	56	57	54	69	66	60	56	58	55
		235	111	500	236	0.01	2	59	52	48	42	38	30	64	60	55	50	52	47	64	60	55	50	52	47	64	60	56	51	53	50	65	61	57	52	54	51
	8	1100	520	2000	944	0.03	7	72	70	65	63	62	58	72	71	67	63	60	58	74	72	68	64	62	61	74	72	69	65	64	63	75	73	69	66	65	65
		700	331	1600	755	0.02	4	69	67	62	59	58	53	68	66	61	57	52	47	72	70	65	61	60	58	72	70	66	62	61	60	73	71	66	63	62	62
		700	331	1200	566	0.02	5	67	63	59	55	53	48	68	65	61	57	55	51	69	66	63	59	58	55	70	67	64	60	59	58	70	68	64	60	60	59
		415	196	800	378	0.01	3	63	58	54	49	46	39	62	59	54	49	46	39	66	62	58	54	54	51	66	63	59	55	56	53	67	64	60	55	57	54
		250	118	500	236	0.01	2	59	52	48	42	38	30	62	58	53	48	43	33	62	58	53	48	50	45	62	58	54	49	51	48	63	59	55	50	52	49
	10	1840	870	2000	944	0.08	19	72	70	65	63	62	58	71	69	67	62	59	58	71	69	68	63	61	60	72	70	69	64	62	62	73	71	69	65	63	63
		1100	520	1600	755	0.04	9	69	67	62	59	58	53	66	63	60	55	50	45	70	67	65	60	58	57	70	68	65	61	60	59	71	68	66	62	61	60
		660	312	1200	566	0.02	5	67	63	59	55	53	48	66	63	60	55	53	50	67	64	61	57	56	53	68	65	62	57	57	56	68	66	62	58	58	57
		410	194	800	378	0.01	3	63	58	54	49	46	39	60	56	52	47	43	36	64	60	56	52	52	49	64	61	57	53	54	51	65	62	58	53	55	52
		375	177	500	236	0.02	4	59	52	48	42	38	30	58	54	51	46	46	40	60	55	53	47	48	44	60	56	54	48	50	46	61	57	54	49	51	48
	12	2000	945	2000	944	0.09	22	72	70	65	63	62	58	71	69	67	62	59	58	71	69	67	62	61	59	70	68	67	62	60	60	71	68	68	63	61	62
		1600	756	1600	755	0.08	20	69	67	62	59	58	53	68	65	64	59	57	55	68	65	64	59	57	55	68	66	65	60	58	58	69	66	65	60	59	59
		900	425	1200	566	0.06	14	67	63	59	55	53	48	66	63	61	57	53	20	65	62	60	55	54	52	66	63	61	56	56	54	66	63	61	57	57	55
		445	210	800	378	0.02	6	63	58	54	49	46	39	63	58	54	49	46	39	63	58	54	49	46	39	62	58	55	50								

## Performance Notes

### Model 33SZ • Series Flow • FPCWTU (DOAS)

#### Explanation of NC Levels:

1. NC levels are calculated from the published raw data and based on procedures outlined in AHRI Standard 885, Appendix E.
2. Discharge sound attenuation deductions are based on environmental effect, duct lining, branch power division, insulated flex duct, end reflection and space effect and are as follows:

Discharge attenuation	Octave Band					
	2	3	4	5	6	7
< 300 cfm	24	28	39	53	59	40
300 – 700 cfm	27	29	40	51	53	39
> 700 cfm	29	30	41	51	52	39

3. Radiated sound attenuation deductions are based on a mineral tile ceiling and environmental effect and are as follows:

Radiated attenuation	Octave Band					
	2	3	4	5	6	7
Total dB reduction	18	19	20	26	31	36

#### Performance Notes for Sound Power Levels:

1. Discharge sound power is the noise emitted from the unit discharge into the downstream duct.
2. Radiated sound power is the breakout noise transmitted through the unit casing walls.
3. Sound power levels are in decibels, dB re 10<sup>-12</sup> watts.
4. All sound data listed by octave bands is raw data without any corrections for room absorption or duct attenuation. Dash (-) in space indicates sound power level is less than 20 dB or equal to background.

4. Min. inlet ΔPs is the minimum static pressure required to achieve rated airflow (damper full open).
5. Dash (-) in space denotes an NC level of less than 20.
6. Discharge (external) static pressure is 0.25" w.g. (63 Pa) in all cases.
7. For a detailed explanation of the attenuation factors and the procedures for calculating room NC levels, please refer to the Performance Data Explanation in this section and the Acoustical Engineering Guidelines in the Engineering Section of this catalog.

5. Minimum inlet ΔPs is the minimum operating pressure of the primary air valve.
6. Asterisk (\*) in space indicates that the minimum inlet static pressure requirement is greater than 0.5" w.g. (125 Pa) at rated airflow.
7. Data derived from independent tests conducted in accordance with ANSI/ASHRAE Standard 130.

## Performance Data • Sensible Chilled Water Coil

Models: 33SZ, 33SZE, 33SZW • FPCWTU (DOAS) • Series Flow

### Unit Size 10

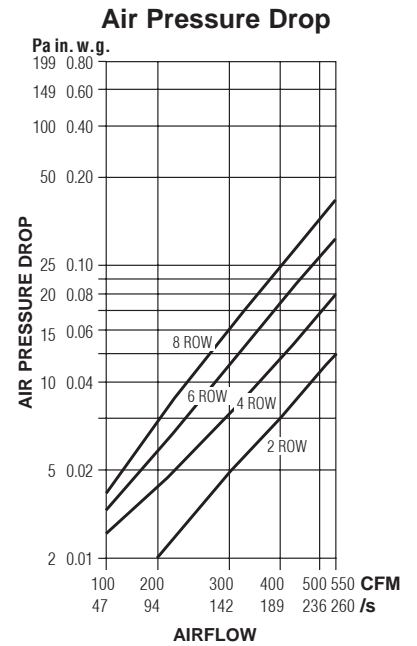
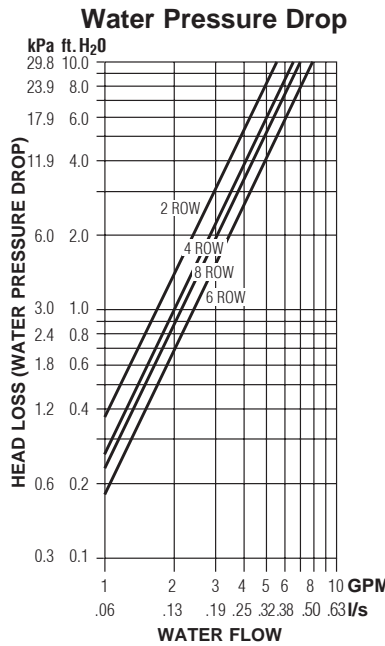
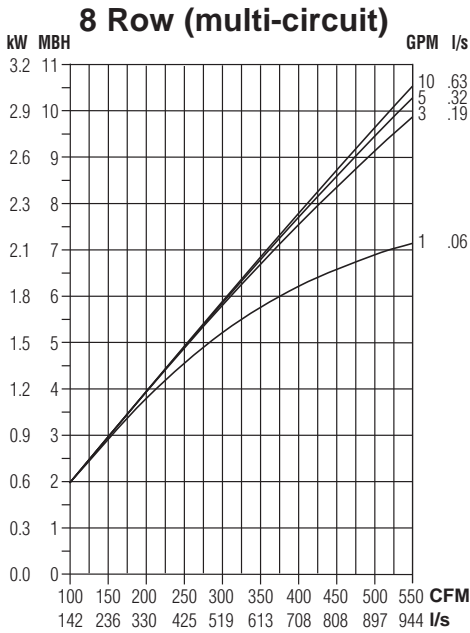
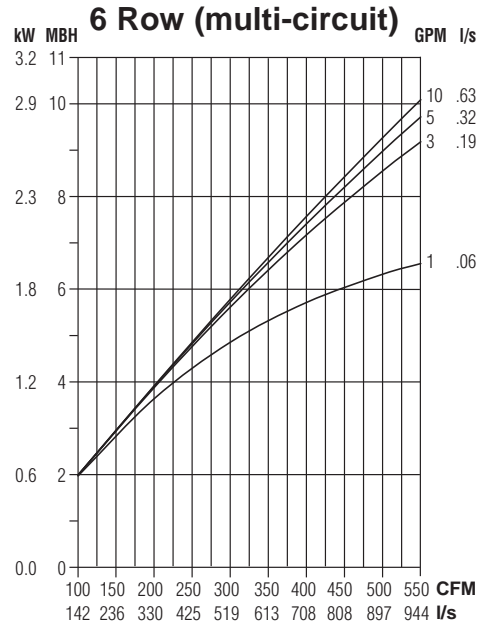
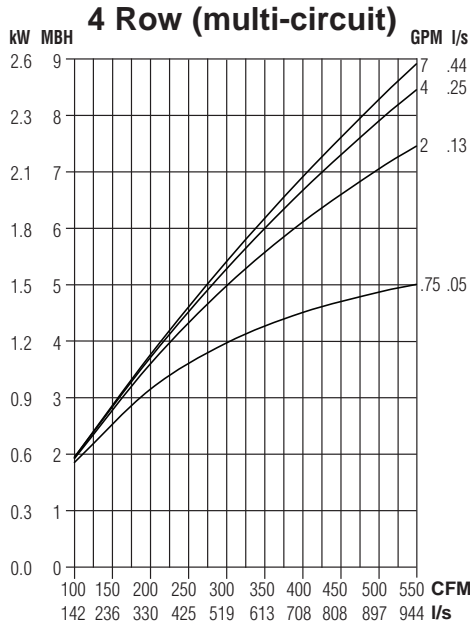
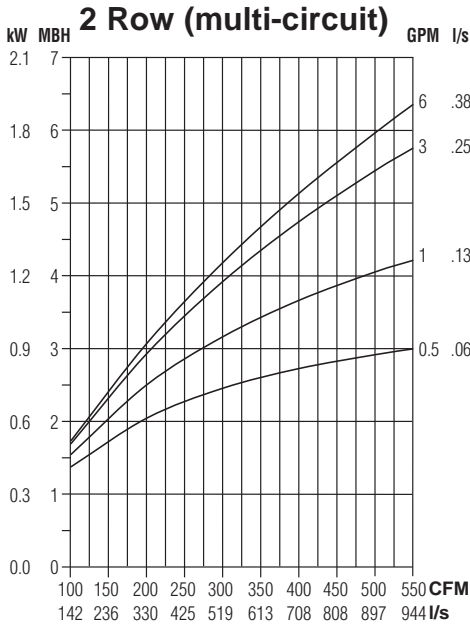

#### NOTES:

- Capacities are in MBH (kW), **thousands of Btu per hour (kiloWatts)**.
- MBH (kW) values are based on:  
 57°F (32°C) Entering Water Temperature (EWT) and 75°F (42°C) Entering Air
- Air Temperature Rise.

Temperature (EAT). Entering water temperature must be above return air dew point to prevent condensation.

$$ATR (°F) = 927 \times \frac{MBH}{cfm}, \quad ATR (°C) = 829 \times \frac{kW}{I/s}$$

- Water Temp. Drop.  
 $WTD (°F) = 2.04 \times \frac{MBH}{GPM}, \quad WTD (°C) = .224 \times \frac{kW}{I/s}$
- Connections: 2, 4, 6 & 8 Row: 7/8" (22) O.D. male solder.

#### Altitude Correction Factors:

Attitude (ft.)	0	1000	2000	3000	4000	5000	6000	7000
Air Density (lb./cu.ft.)	0.075	0.072	0.070	0.067	0.065	0.063	0.060	0.058
Sensible Capacity	1000	0.960	0.930	0.900	0.860	0.830	0.800	0.700

## Performance Data • Sensible Chilled Water Coil

Models: 33SZ, 33SZE, 33SZW • FPCWTU (DOAS) • Series Flow

### Unit Size 30

2 Row (multi-circuit)

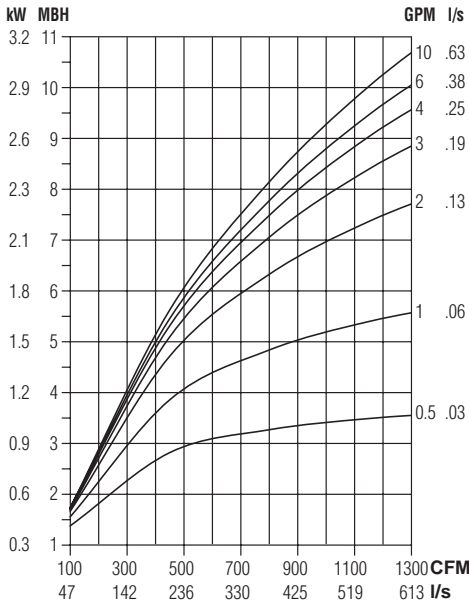

4 Row (multi-circuit)

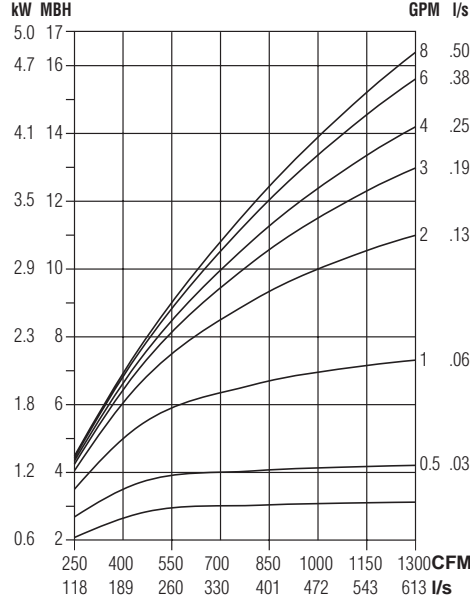

6 Row (multi-circuit)

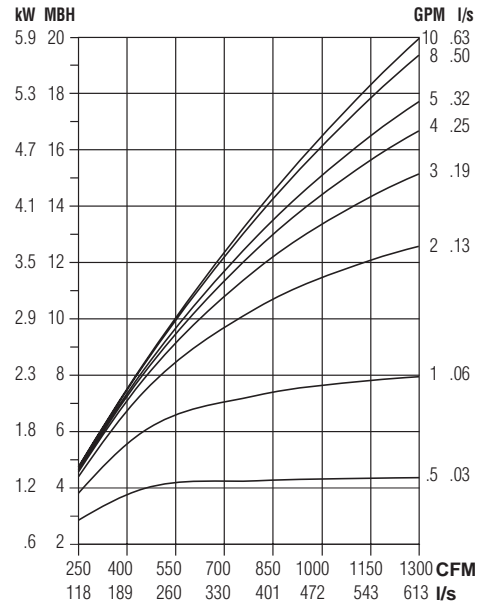

8 Row (multi-circuit)

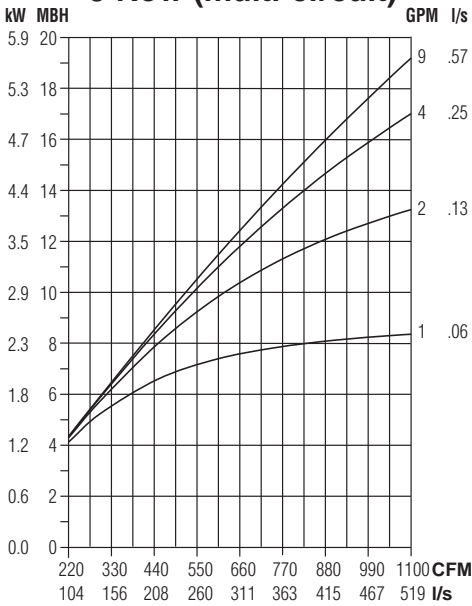

Water Pressure Drop

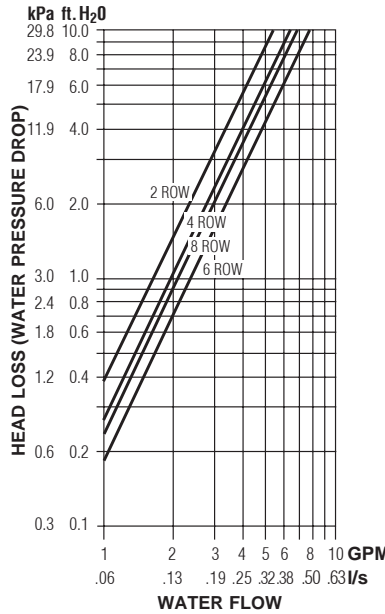

Air Pressure Drop

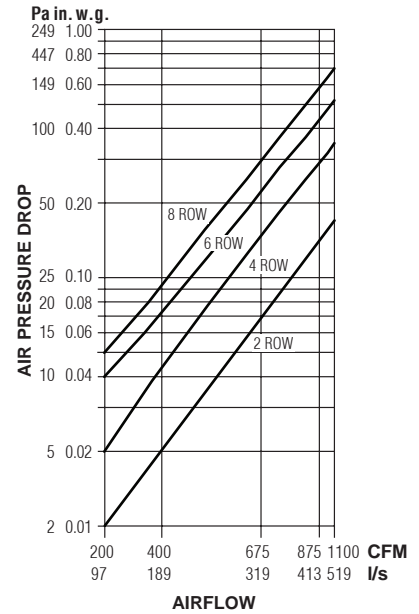

### NOTES:

- Capacities are in MBH (kW), **thousands of Btu per hour (kiloWatts)**.
- MBH (kW) values are based on:  
57°F (32°C) Entering Water Temperature (EWT) and 75°F (42°C) Entering Air

Temperature (EAT). Entering water temperature must be above return air dew point to prevent condensation.

- Air Temperature Rise.

$$ATR (°F) = 927 \times \frac{MBH}{cfm}, ATR (°C) = 829 \times \frac{kW}{l/s}$$

- Water Temp. Drop.

$$WTD (°F) = 2.04 \times \frac{MBH}{GPM}, WTD (°C) = .224 \times \frac{kW}{l/s}$$

- Connections: 2, 4, 6 & 8 Row: 7/8" (22) O.D. male solder.

### Altitude Correction Factors:

Attitude (ft.)	0	1000	2000	3000	4000	5000	6000	7000
Air Density (lb./cu.ft.)	0.075	0.072	0.070	0.067	0.065	0.063	0.060	0.058
Sensible Capacity	1000	0.960	0.930	0.900	0.860	0.830	0.800	0.700

FAN POWERED TERMINAL UNITS



## Performance Data • Sensible Chilled Water Coil

Models: 33SZ, 33SZE, 33SZW • FPCWTU (DOAS) • Series Flow

### Unit Size 35 (Low Profile)

**2 Row (multi-circuit)**

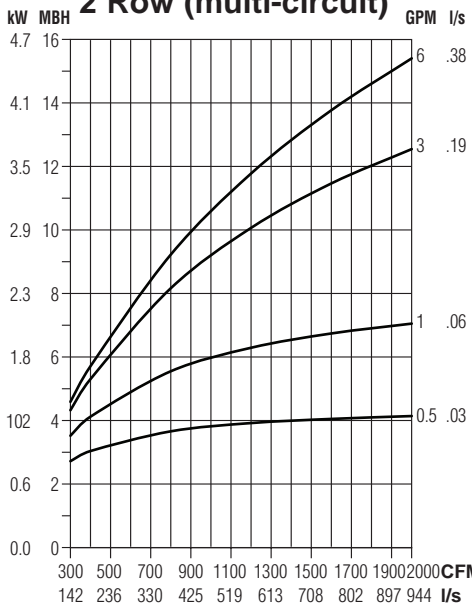

**4 Row (multi-circuit)**

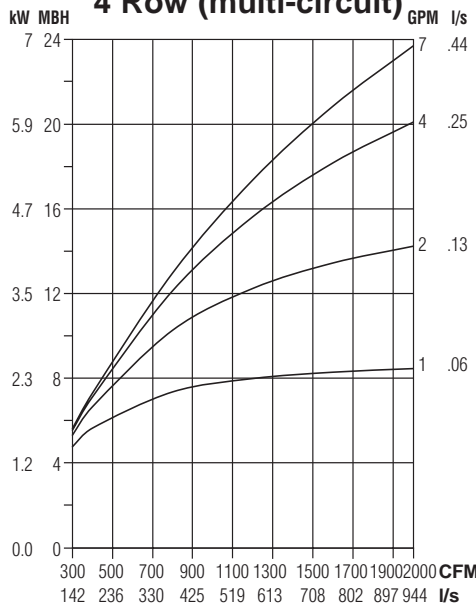

**6 Row (multi-circuit)**

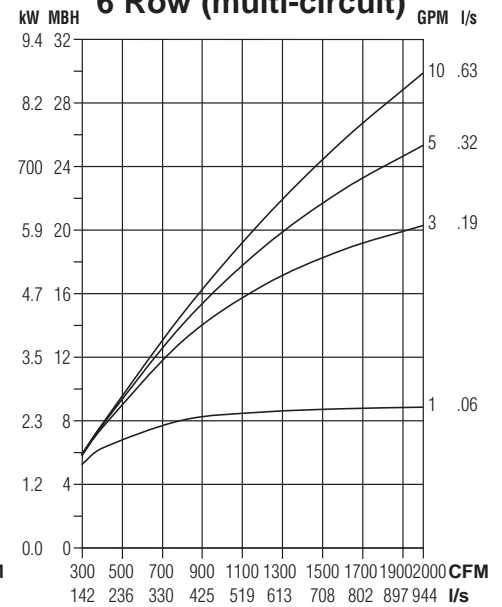

**8 Row (multi-circuit)**

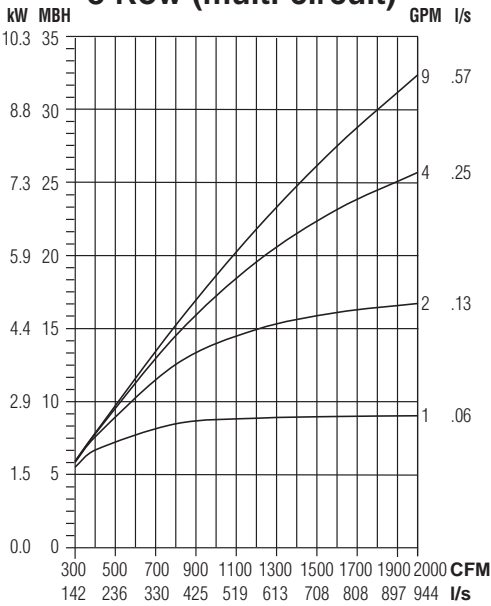

**Water Pressure Drop**

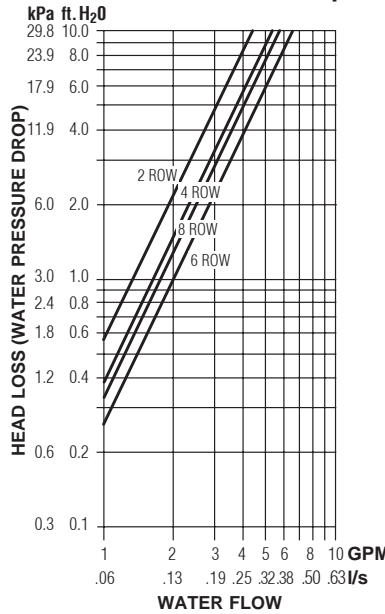

**Air Pressure Drop**

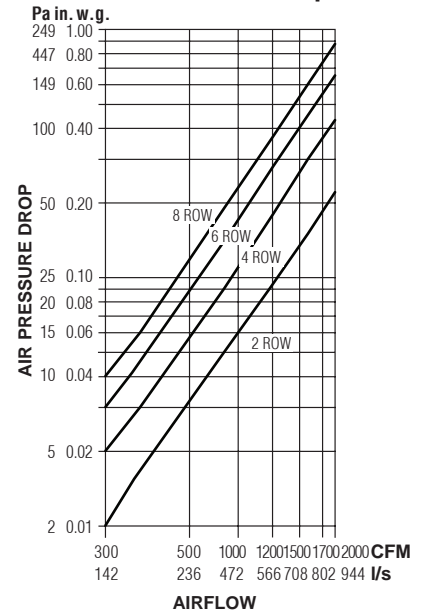

**NOTES:**

1. Capacities are in MBH (kW), **thousands of Btu per hour (kiloWatts)**.
2. MBH (kW) values are based on:  
57°F (32°C) Entering Water Temperature (EWT) and 75°F (42°C) Entering Air
3. Air Temperature Rise.

Temperature (EAT). Entering water temperature must be above return air dew point to prevent condensation.

ATR (°F) =  $927 \times \frac{\text{MBH}}{\text{cfm}}$ , ATR (°C) =  $829 \times \frac{\text{kW}}{\text{l/s}}$

4. Water Temp. Drop.  
WTD (°F) =  $2.04 \times \frac{\text{MBH}}{\text{GPM}}$ , WTD (°C) =  $.224 \times \frac{\text{kW}}{\text{l/s}}$
5. Connections: 2, 4, 6 & 8 Row: 7/8" (22) O.D. male solder.

**Altitude Correction Factors:**

Attitude (ft.)	0	1000	2000	3000	4000	5000	6000	7000
Air Density (lb./cu.ft.)	0.075	0.072	0.070	0.067	0.065	0.063	0.060	0.058
Sensible Capacity	1000	0.960	0.930	0.900	0.860	0.830	0.800	0.700

FAN POWERED TERMINAL UNITS

## Performance Data • Sensible Chilled Water Coil

Models: 33SZ, 33SZE, 33SZW • FPCWTU (DOAS) • Series Flow

### Unit Size 40

#### 2 Row (multi-circuit)

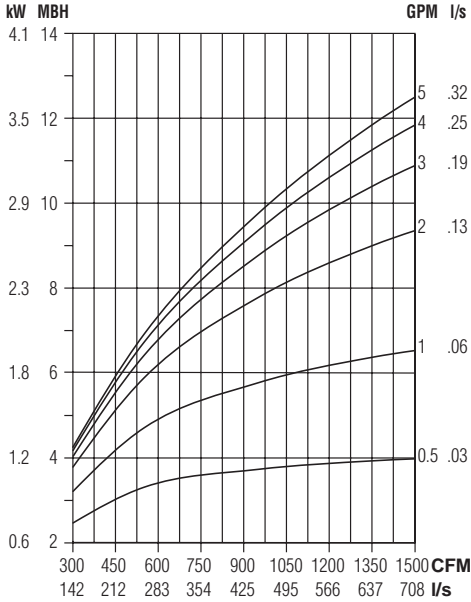

#### 4 Row (multi-circuit)

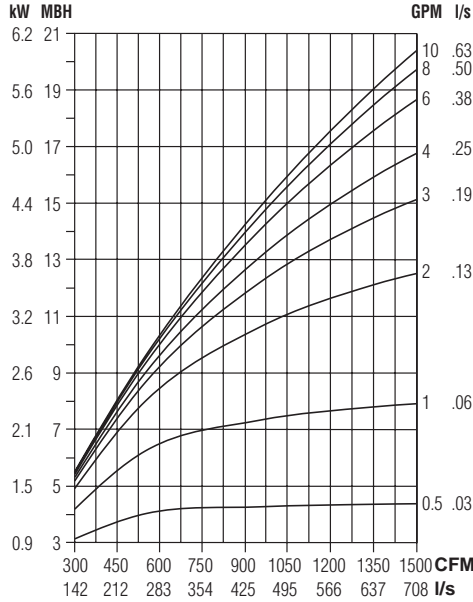

#### 6 Row (multi-circuit)

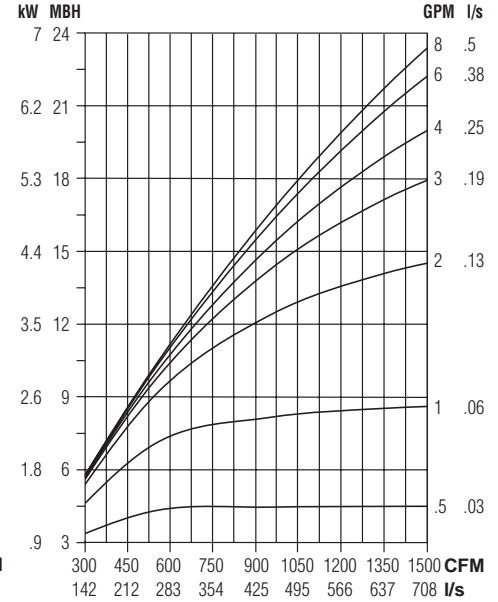

#### 8 Row (multi-circuit)

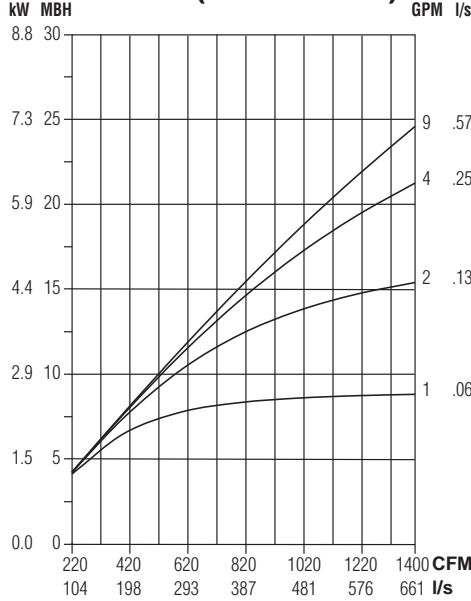

#### Water Pressure Drop

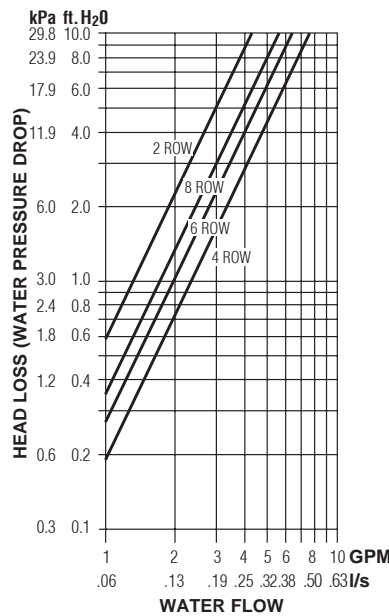

#### Air Pressure Drop

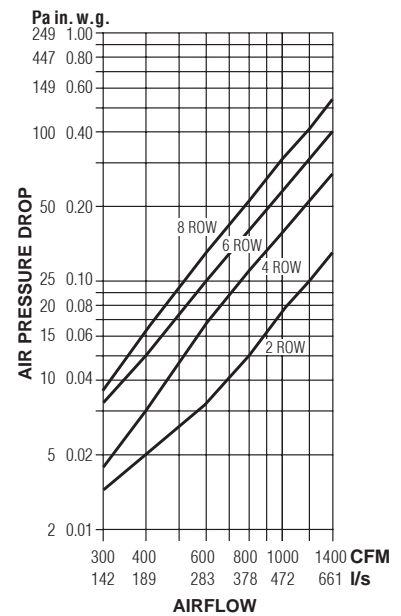

#### NOTES:

- Capacities are in MBH (kW), **thousands of Btu per hour (kiloWatts)**.
- MBH (kW) values are based on:  
57°F (32°C) Entering Water Temperature (EWT) and 75°F (42°C) Entering Air

Temperature (EAT). Entering water temperature must be above return air dew point to prevent condensation.

- Air Temperature Rise.

$$ATR (°F) = 927 \times \frac{MBH}{cfm}, ATR (°C) = 829 \times \frac{kW}{I/s}$$

- Water Temp. Drop.

$$WTD (°F) = 2.04 \times \frac{MBH}{GPM}, WTD (°C) = .224 \times \frac{kW}{I/s}$$

- Connections: 2, 4 & 6 Row: 7/8" (22) O.D. male solder.

#### Altitude Correction Factors:

Attitude (ft.)	0	1000	2000	3000	4000	5000	6000	7000
Air Density (lb./cu.ft.)	0.075	0.072	0.070	0.067	0.065	0.063	0.060	0.058
Sensible Capacity	1000	0.960	0.930	0.900	0.860	0.830	0.800	0.700

FAN POWERED TERMINAL UNITS



## Performance Data • Sensible Chilled Water Coil

Models: 33SZ, 33SZE, 33SZW • FPCWTU (DOAS) • Series Flow

### Unit Size 50

#### 2 Row (multi-circuit)

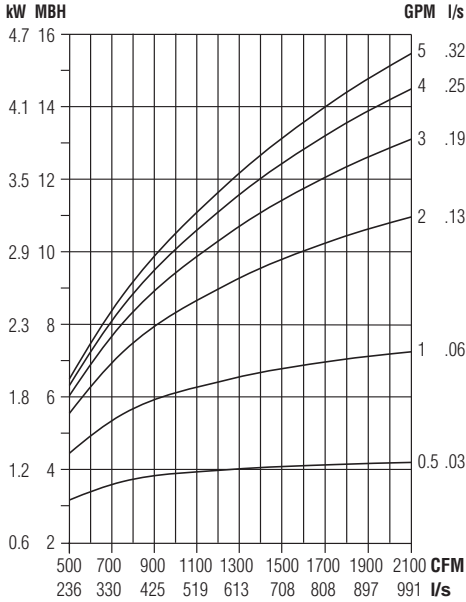

#### 4 Row (multi-circuit)

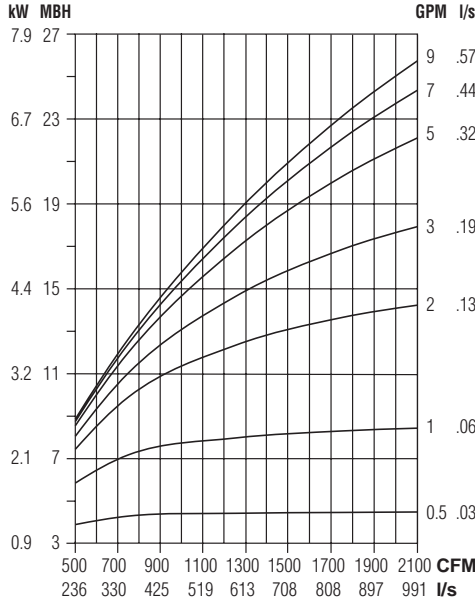

#### 6 Row (multi-circuit)

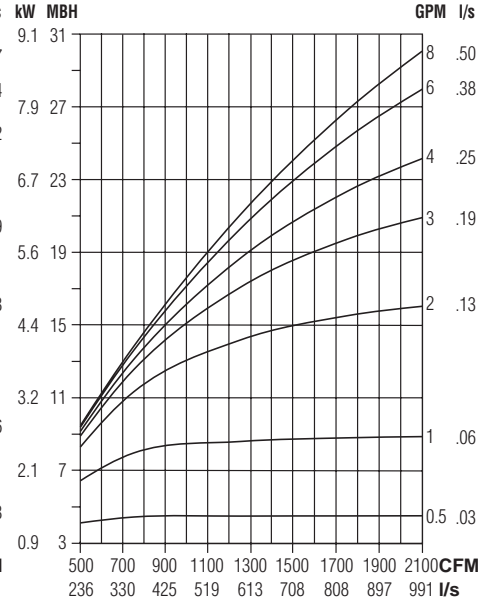

#### 8 Row (multi-circuit)

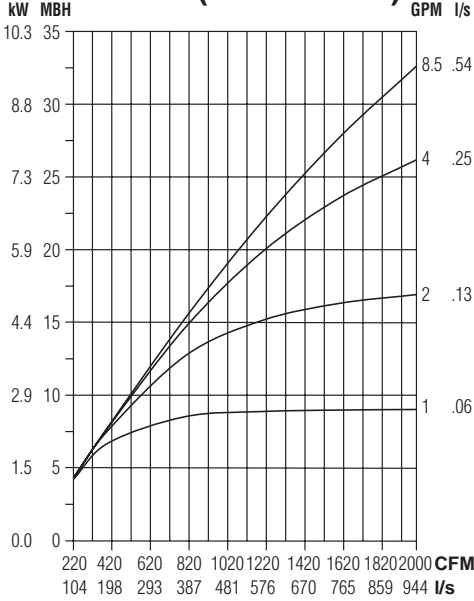

#### Water Pressure Drop

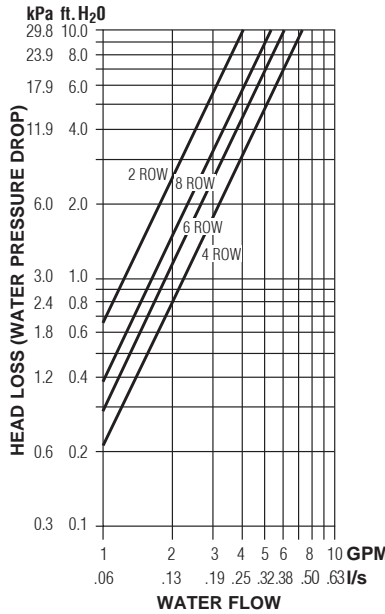

#### Air Pressure Drop

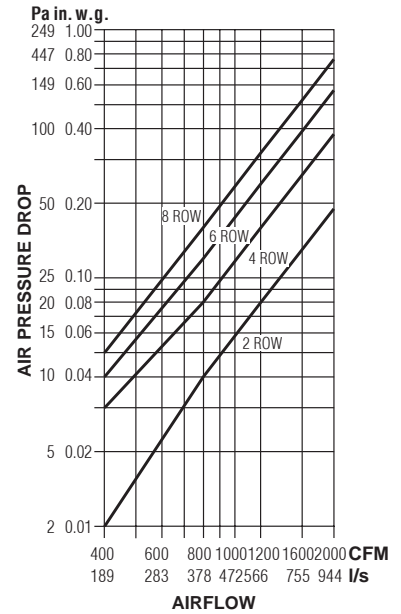

#### NOTES:

- Capacities are in MBH (kW), **thousands of Btu per hour (kiloWatts)**.
- MBH (kW) values are based on:  
57°F (32°C) Entering Water Temperature (EWT) and 75°F (42°C) Entering Air

Temperature (EAT). Entering water temperature must be above return air dew point to prevent condensation.

- Air Temperature Rise.

$$ATR (°F) = 927 \times \frac{MBH}{cfm}, ATR (°C) = 829 \times \frac{kW}{l/s}$$

- Water Temp. Drop.

$$WTD (°F) = 2.04 \times \frac{MBH}{GPM}, WTD (°C) = .224 \times \frac{kW}{l/s}$$

- Connections: 2, 4 & 6 Row: 7/8" (22) O.D. male solder.

#### Altitude Correction Factors:

Attitude (ft.)	0	1000	2000	3000	4000	5000	6000	7000
Air Density (lb./cu.ft.)	0.075	0.072	0.070	0.067	0.065	0.063	0.060	0.058
Sensible Capacity	1000	0.960	0.930	0.900	0.860	0.830	0.800	0.700

FAN POWERED TERMINAL UNITS



## Performance Data • Sensible Chilled Water Coil

Models: 33SZ, 33SZE, 33SZW • FPCWTU (DOAS) • Series Flow

### Unit Size 55

2 Row (multi-circuit)

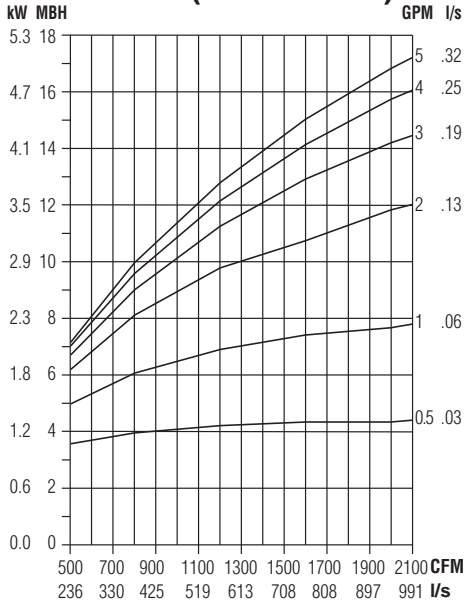

4 Row (multi-circuit)

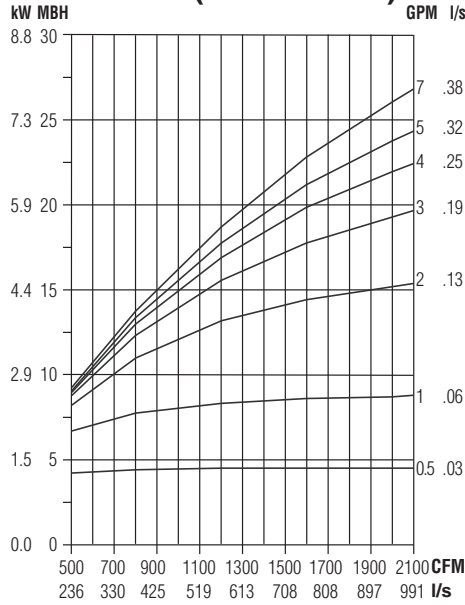

6 Row (multi-circuit)

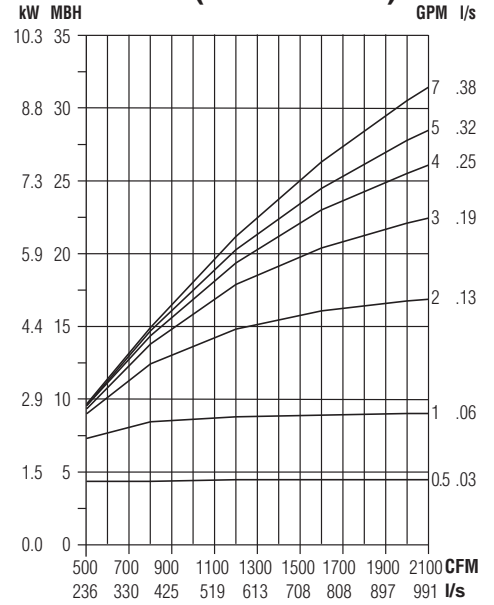

8 Row (multi-circuit)

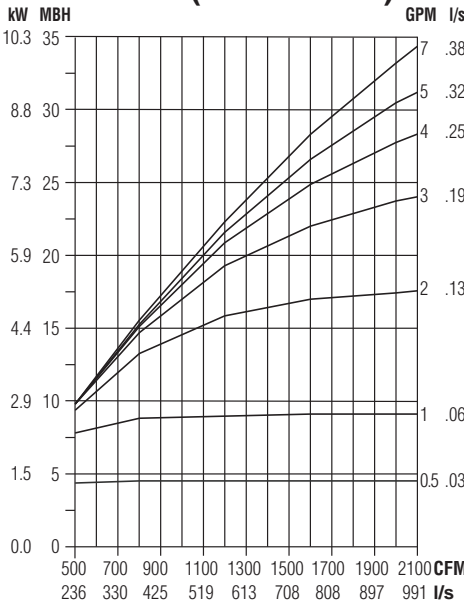

Water Pressure Drop

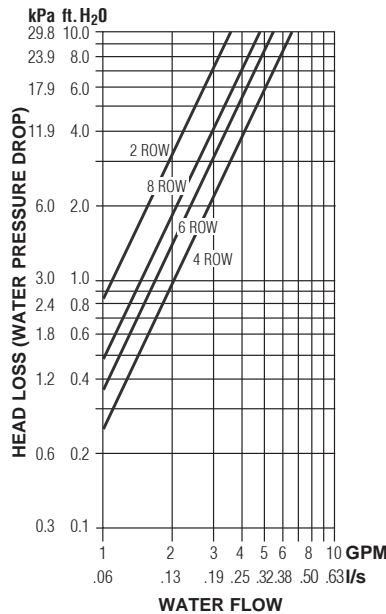

Air Pressure Drop

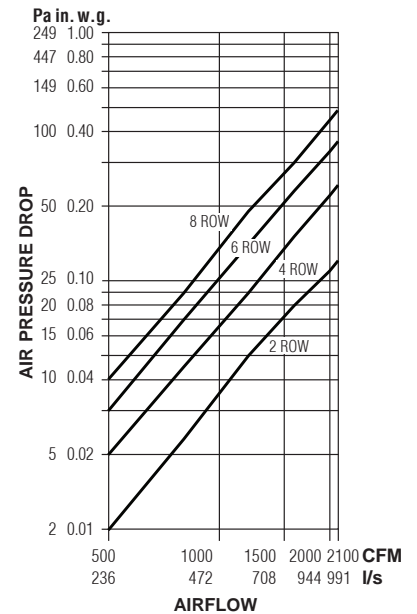

**NOTES:**

- Capacities are in MBH (kW), **thousands of Btu per hour (kiloWatts)**.
- MBH (kW) values are based on:  
57°F (32°C) Entering Water Temperature (EWT) and 75°F (42°C) Entering Air
- Air Temperature Rise.  
 $ATR (°F) = 927 \times \frac{MBH}{cfm}$ ,  $ATR (°C) = 829 \times \frac{kW}{l/s}$

Temperature (EAT). Entering water temperature must be above return air dew point to prevent condensation.

- Water Temp. Drop.  
 $WTD (°F) = 2.04 \times \frac{MBH}{GPM}$ ,  $WTD (°C) = .224 \times \frac{kW}{l/s}$
- Connections: 2, 4, 6 & 8 Row: 7/8" (22) O.D. male solder.

**Altitude Correction Factors:**

Attitude (ft.)	0	1000	2000	3000	4000	5000	6000	7000
Air Density (lb./cu.ft.)	0.075	0.072	0.070	0.067	0.065	0.063	0.060	0.058
Sensible Capacity	1000	0.960	0.930	0.900	0.860	0.830	0.800	0.700

FAN POWERED TERMINAL UNITS



## Performance Data • Sensible Chilled Water Coil

Models: 33SZ, 33SZE, 33SZW • FPCWTU (DOAS) • Series Flow

### Unit Size 10

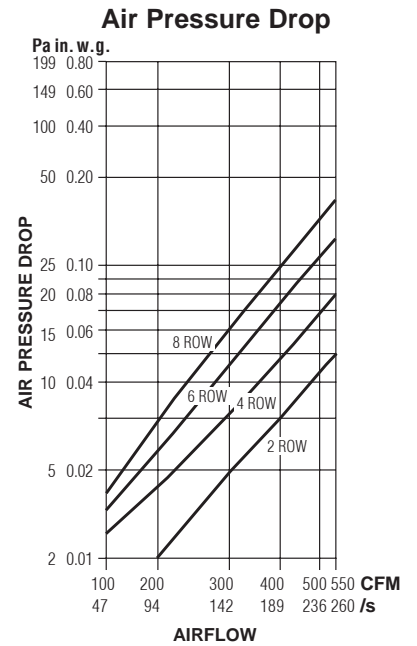
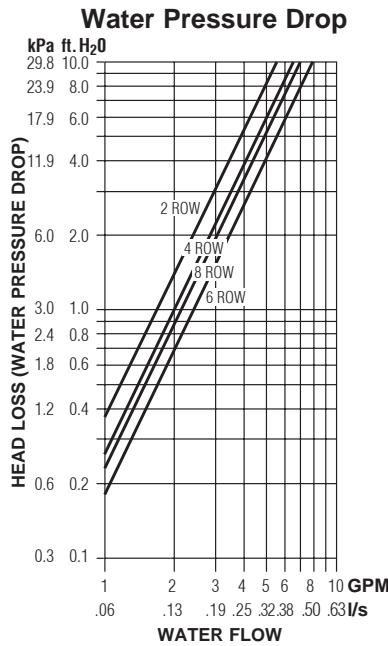
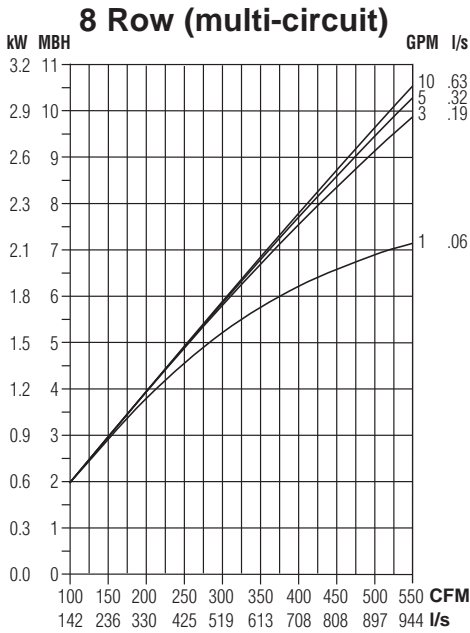
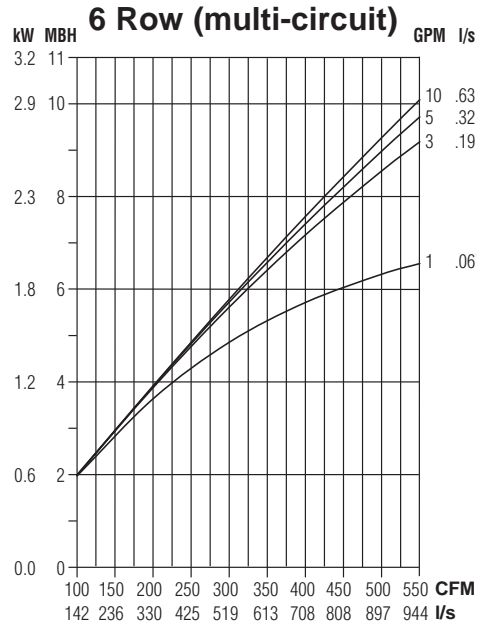
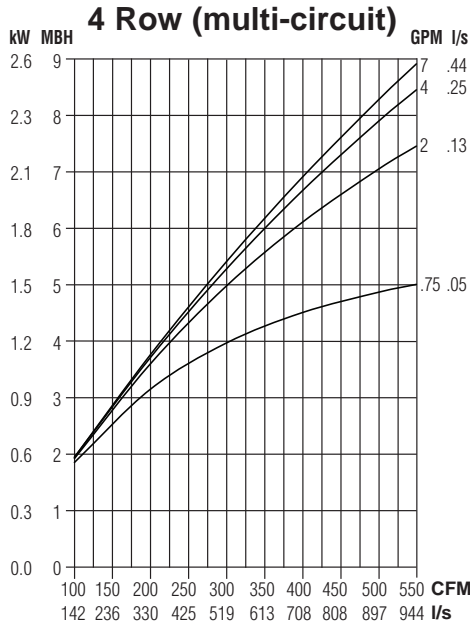
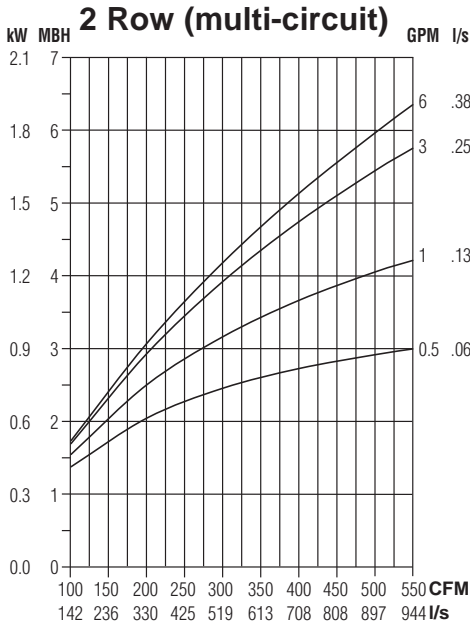

#### NOTES:

- Capacities are in MBH (kW), **thousands of Btu per hour (kiloWatts)**.
- MBH (kW) values are based on:  
57°F (32°C) Entering Water Temperature (EWT) and 75°F (42°C) Entering Air

Temperature (EAT). Entering water temperature must be above return air dew point to prevent condensation.

- Air Temperature Rise.

$$ATR (°F) = 927 \times \frac{MBH}{cfm}, ATR (°C) = 829 \times \frac{kW}{I/s}$$

- Water Temp. Drop.

$$WTD (°F) = 2.04 \times \frac{MBH}{GPM}, WTD (°C) = .224 \times \frac{kW}{I/s}$$

- Connections: 2, 4, 6 & 8 Row: 7/8" (22) O.D. male solder.

#### Altitude Correction Factors:

Attitude (ft.)	0	1000	2000	3000	4000	5000	6000	7000
Air Density (lb./cu.ft.)	0.075	0.072	0.070	0.067	0.065	0.063	0.060	0.058
Sensible Capacity	1000	0.960	0.930	0.900	0.860	0.830	0.800	0.700

FAN POWERED TERMINAL UNITS

## Performance Data • Hot Water Coil

Model: 33SZW • FPCWTU (DOAS) • Series Flow

### Unit Size 10

1 Row (single-circuit)

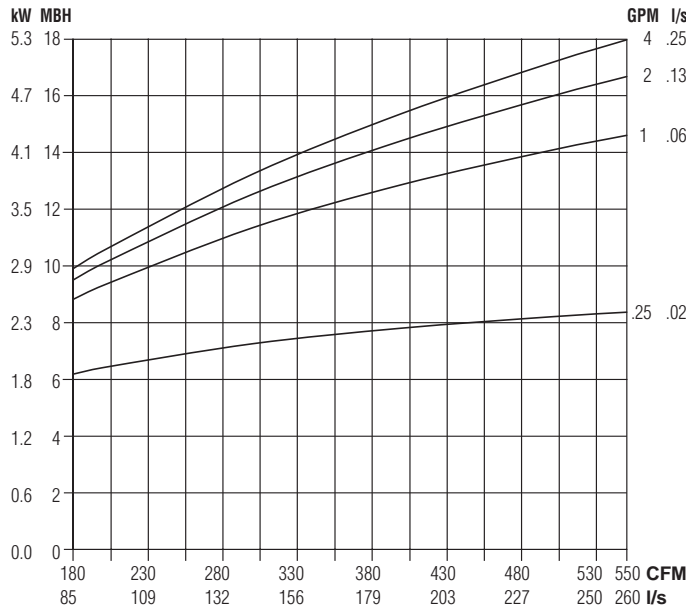

2 Row (multi-circuit)

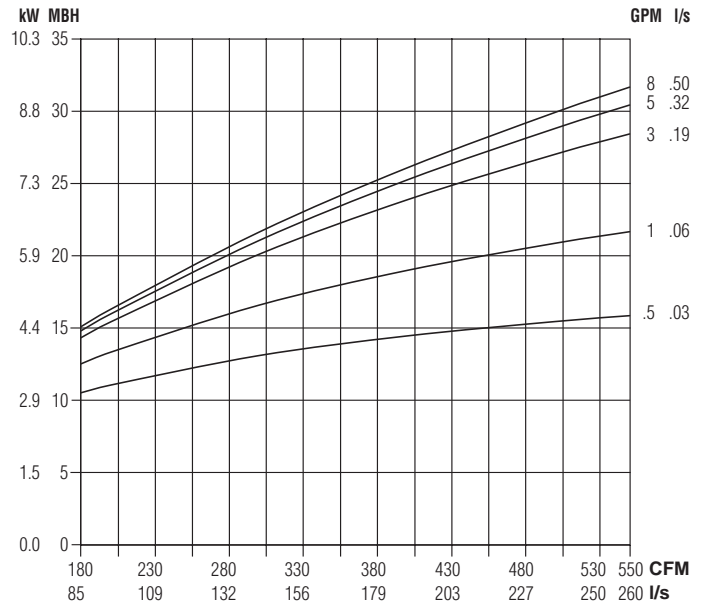

Water Pressure Drop

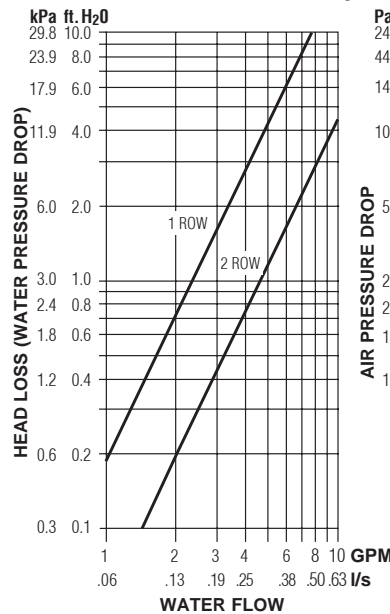

Air Pressure Drop

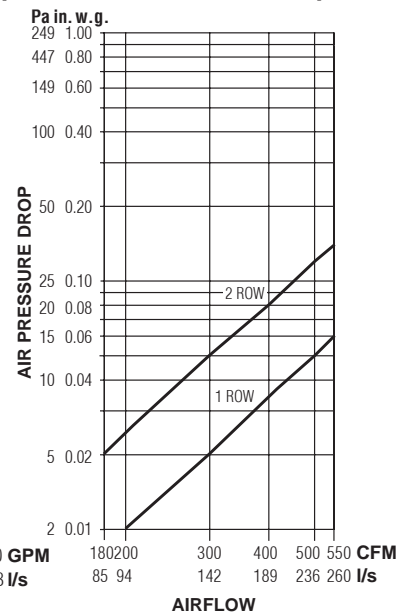

### NOTES:

- Capacities are in MBH (kW), *thousands of Btu per hour (kiloWatts)*.
- MBH (kW) values are based on a  $\Delta t$  (temperature difference) of 120°F (67°C) between entering air and entering water. For other  $\Delta t$ 's; multiply the MBH (kW) values by the factors below.

- Air Temperature Rise.  
 $ATR (^\circ F) = 927 \times \frac{MBH}{cfm}$ ,  $ATR (^\circ C) = 829 \times \frac{kW}{l/s}$
- Water Temp. Drop.  
 $WTD (^\circ F) = 2.04 \times \frac{MBH}{GPM}$ ,  $WTD (^\circ C) = .224 \times \frac{kW}{l/s}$
- Connections: 1 Row 1/2" (13) and 2 Row 5/8" (16); O.D. male solder.

### Altitude Correction Factors:

Altitude ft. (m)	Sensible Heat Factor
0 (0)	1.00
2000 (610)	0.94
3000 (914)	0.90
4000 (1219)	0.87
5000 (1524)	0.84
6000 (1829)	0.81
7000 (2134)	0.78

### Correction factors at other entering conditions:

$\Delta t$ °F (°C)	50 (28)	60 (33)	70 (39)	80 (44)	90 (50)	100 (56)	110 (61)	120 (67)	130 (72)	140 (78)	150 (83)
Factor	.417 (.418)	.500 (.493)	.583 (.582)	.667 (.657)	.750 (.746)	.833 (.836)	.917 (.910)	1.00 (1.00)	1.08 (1.08)	1.17 (1.16)	1.25 (1.24)

## Performance Data • Sensible Chilled Water Coil

Models: 33SZ, 33SZE, 33SZW • FPCWTU (DOAS) • Series Flow

### Unit Size 30

#### 2 Row (multi-circuit)

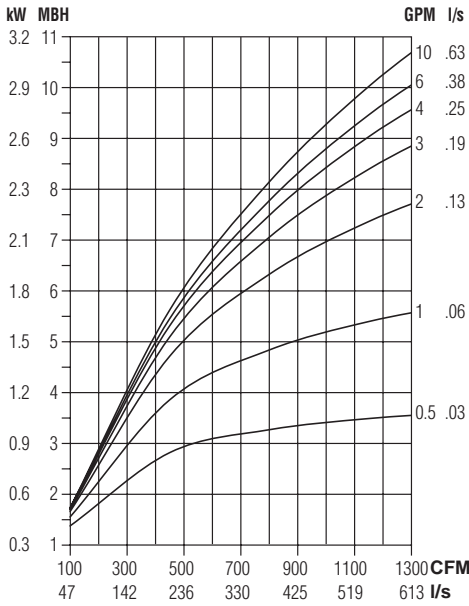

#### 4 Row (multi-circuit)

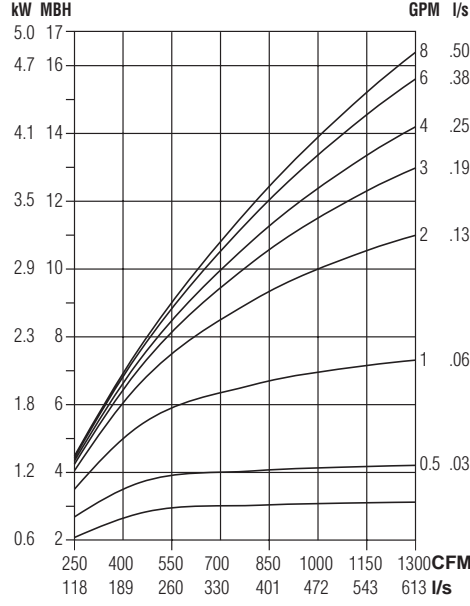

#### 6 Row (multi-circuit)

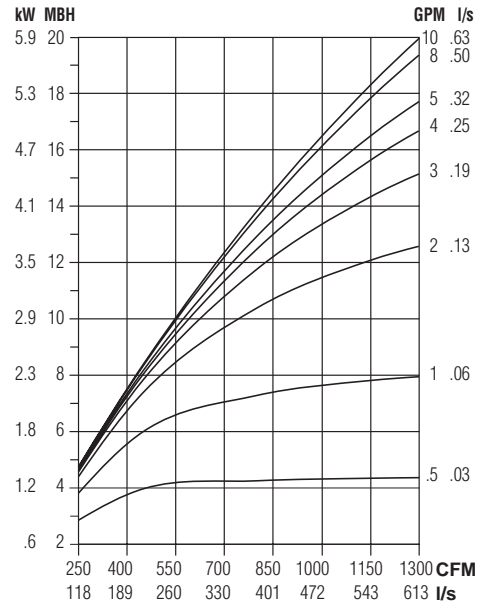

#### 8 Row (multi-circuit)

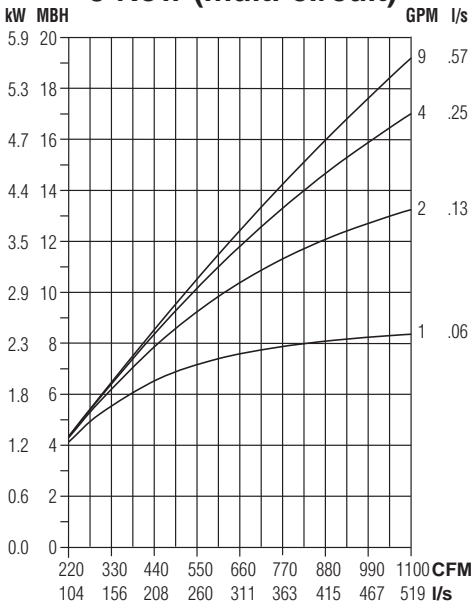

#### Water Pressure Drop

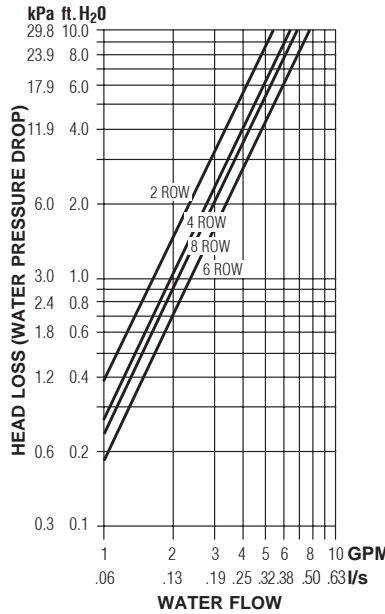

#### Air Pressure Drop

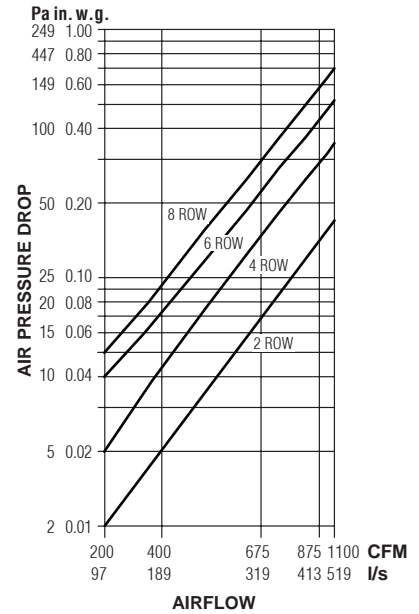

### NOTES:

- Capacities are in MBH (kW), **thousands of Btu per hour (kiloWatts)**.
- MBH (kW) values are based on:  
57°F (32°C) Entering Water Temperature (EWT) and 75°F (42°C) Entering Air

Temperature (EAT). Entering water temperature must be above return air dew point to prevent condensation.

- Air Temperature Rise.

$$ATR (°F) = 927 \times \frac{MBH}{cfm}, \quad ATR (°C) = 829 \times \frac{kW}{I/s}$$

- Water Temp. Drop.

$$WTD (°F) = 2.04 \times \frac{MBH}{GPM}, \quad WTD (°C) = .224 \times \frac{kW}{I/s}$$

- Connections: 2, 4, 6 & 8 Row: 7/8" (22) O.D. male solder.

### Altitude Correction Factors:

Attitude (ft.)	0	1000	2000	3000	4000	5000	6000	7000
Air Density (lb./cu.ft.)	0.075	0.072	0.070	0.067	0.065	0.063	0.060	0.058
Sensible Capacity	1000	0.960	0.930	0.900	0.860	0.830	0.800	0.700

FAN POWERED TERMINAL UNITS



## Performance Data • Hot Water Coil

Model: 33SZW • FPCWTU (DOAS) • Series Flow

### Unit Size 30

#### 1 Row (single-circuit)

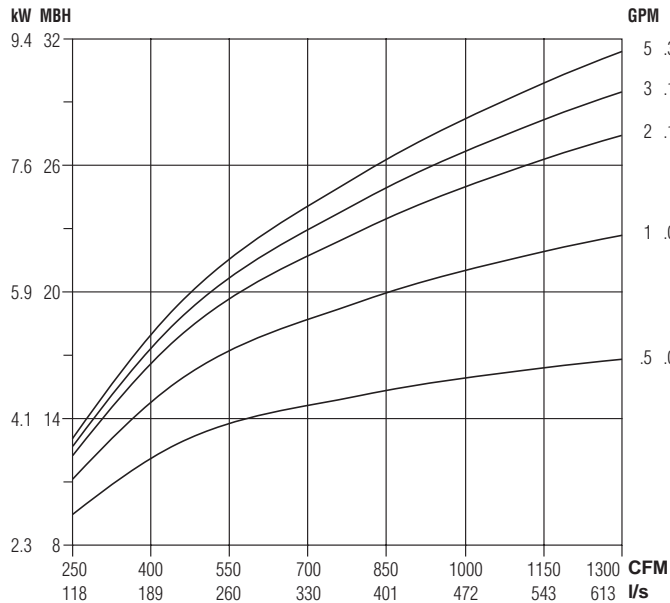

#### 2 Row (multi-circuit)

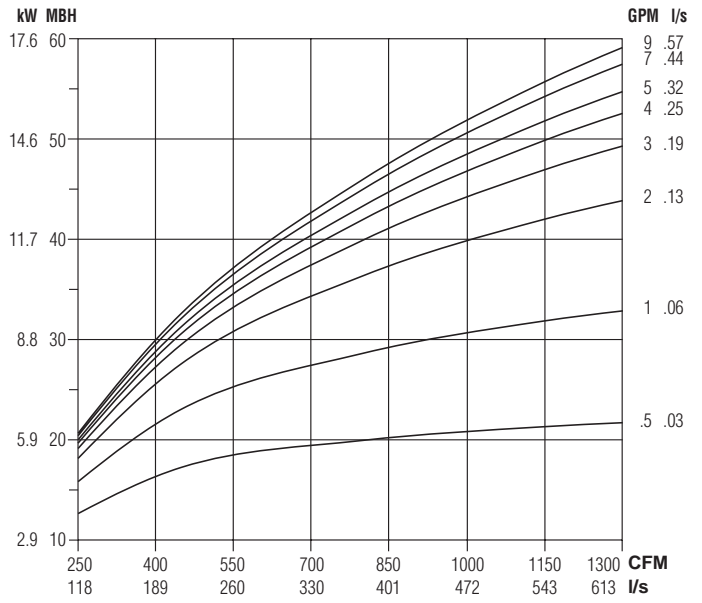

#### Water Pressure Drop

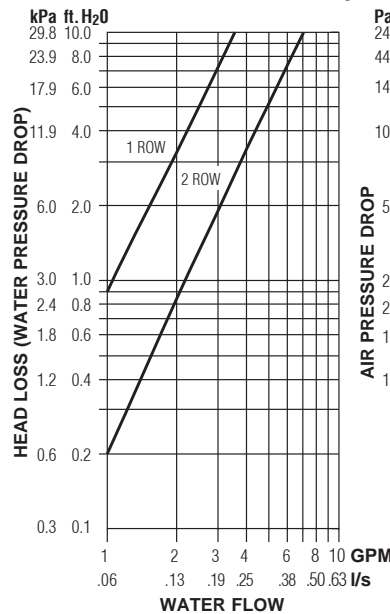

#### Air Pressure Drop

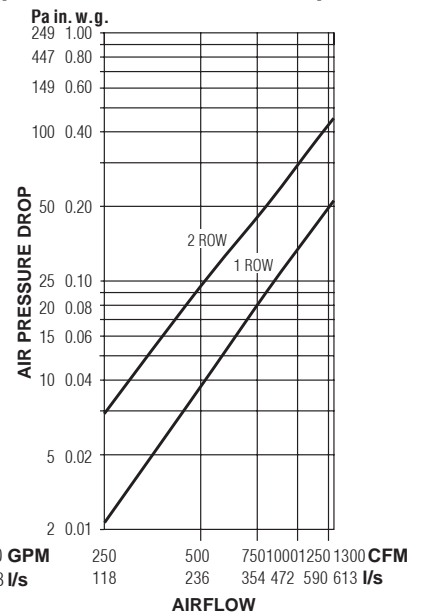

#### NOTES:

- Capacities are in MBH (kW), *thousands of Btu per hour (kiloWatts)*.
- MBH (kW) values are based on a  $\Delta t$  (temperature difference) of 120°F (67°C) between entering air and entering water. For other  $\Delta t$ 's; multiply the MBH (kW) values by the factors below.

- Air Temperature Rise.  
 $ATR (^\circ F) = 927 \times \frac{MBH}{cfm}$ ,  $ATR (^\circ C) = 829 \times \frac{kW}{l/s}$
- Water Temp. Drop.  
 $WTD (^\circ F) = 2.04 \times \frac{MBH}{GPM}$ ,  $WTD (^\circ C) = .224 \times \frac{kW}{l/s}$
- Connections: 1 Row 1/2" (13) and 2 Row 5/8" (16); O.D. male solder.

#### Altitude Correction Factors:

Altitude ft. (m)	Sensible Heat Factor
0 (0)	1.00
2000 (610)	0.94
3000 (914)	0.90
4000 (1219)	0.87
5000 (1524)	0.84
6000 (1829)	0.81
7000 (2134)	0.78

#### Correction factors at other entering conditions:

$\Delta t$ °F (°C)	50 (28)	60 (33)	70 (39)	80 (44)	90 (50)	100 (56)	110 (61)	120 (67)	130 (72)	140 (78)	150 (83)
Factor	.417 (.418)	.500 (.493)	.583 (.582)	.667 (.657)	.750 (.746)	.833 (.836)	.917 (.910)	1.00 (1.00)	1.08 (1.08)	1.17 (1.16)	1.25 (1.24)

## Performance Data • Sensible Chilled Water Coil

Models: 33SZ, 33SZE, 33SZW • FPCWTU (DOAS) • Series Flow

### Unit Size 35 (Low Profile)

**2 Row (multi-circuit)**

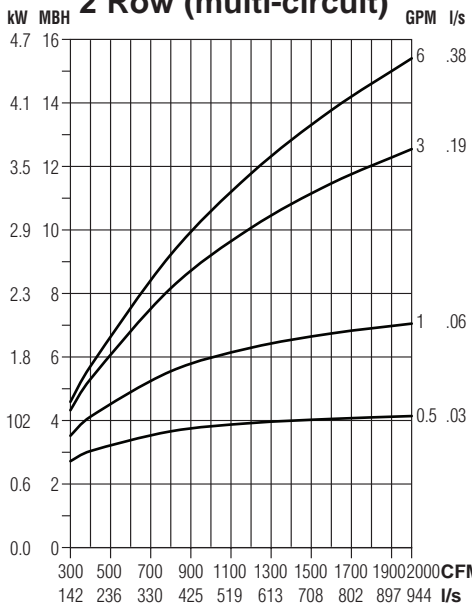

**4 Row (multi-circuit)**

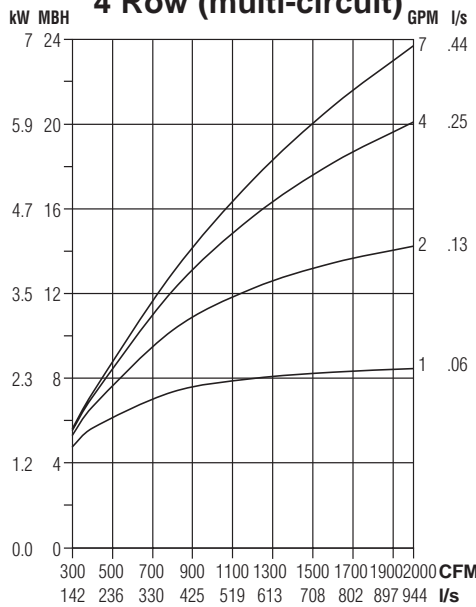

**6 Row (multi-circuit)**

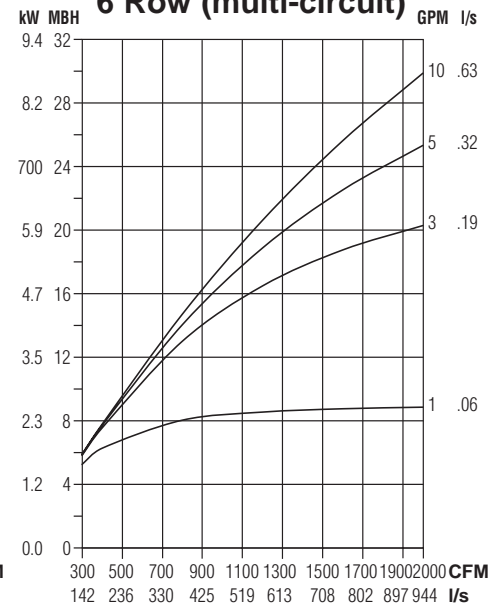

**8 Row (multi-circuit)**

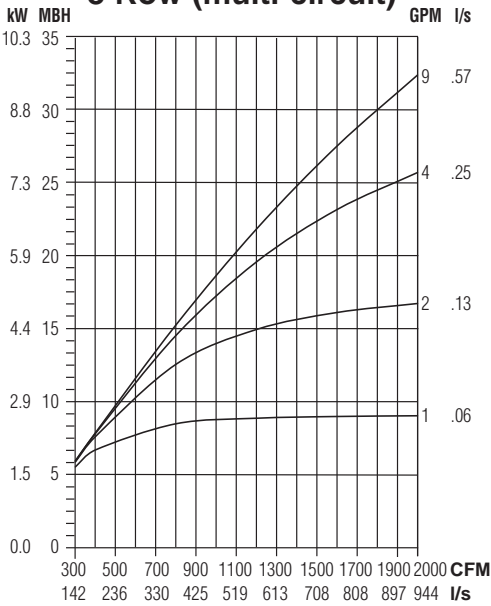

**Water Pressure Drop**

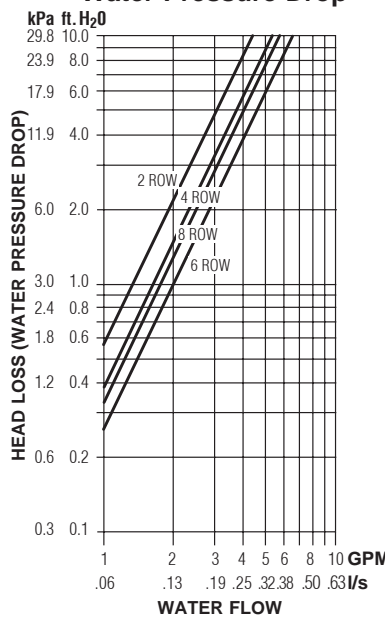

**Air Pressure Drop**

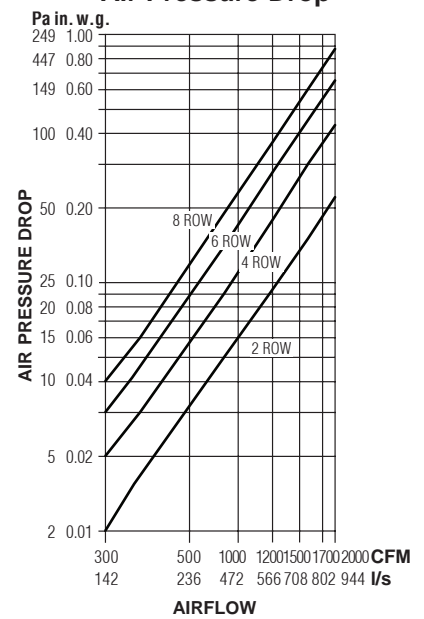

**NOTES:**

- Capacities are in MBH (kW), **thousands of Btu per hour (kiloWatts)**.
- MBH (kW) values are based on:  
57°F (32°C) Entering Water Temperature (EWT) and 75°F (42°C) Entering Air
- Air Temperature Rise.

Temperature (EAT). Entering water temperature must be above return air dew point to prevent condensation.

ATR (°F) =  $927 \times \frac{\text{MBH}}{\text{cfm}}$ , ATR (°C) =  $829 \times \frac{\text{kW}}{\text{l/s}}$

- Water Temp. Drop.  
WTD (°F) =  $2.04 \times \frac{\text{MBH}}{\text{GPM}}$ , WTD (°C) =  $.224 \times \frac{\text{kW}}{\text{l/s}}$
- Connections: 2, 4, 6 & 8 Row: 7/8" (22) O.D. male solder.

**Altitude Correction Factors:**

Attitude (ft.)	0	1000	2000	3000	4000	5000	6000	7000
Air Density (lb./cu.ft.)	0.075	0.072	0.070	0.067	0.065	0.063	0.060	0.058
Sensible Capacity	1000	0.960	0.930	0.900	0.860	0.830	0.800	0.700

FAN POWERED TERMINAL UNITS



## Performance Data • Hot Water Coil

Model: 33SZW • FPCWTU (DOAS) • Series Flow

### Unit Size 35 (Low Profile)

#### 1 Row (multi-circuit)

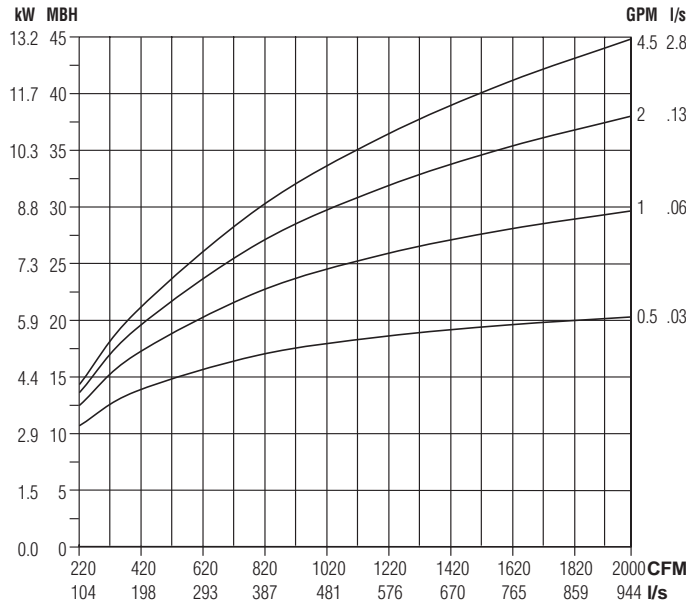

#### 2 Row (multi-circuit)

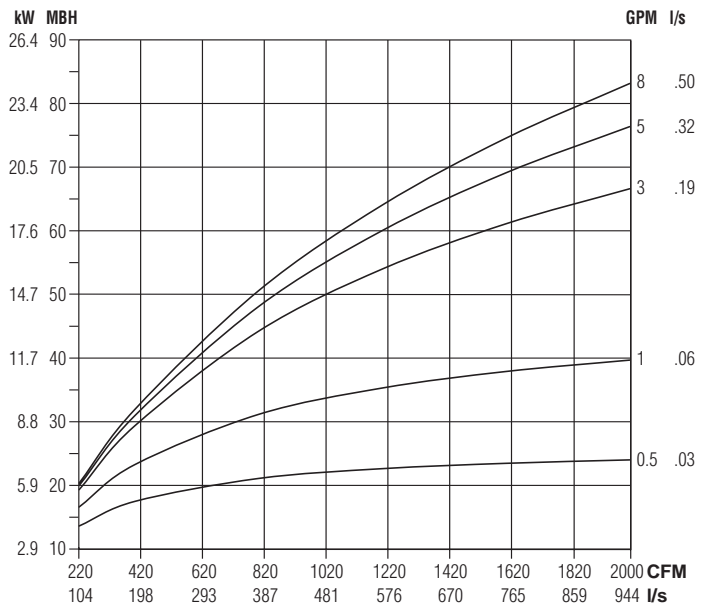

#### Water Pressure Drop

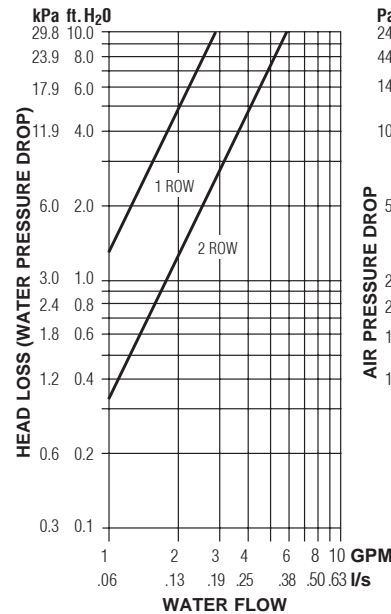

#### Air Pressure Drop

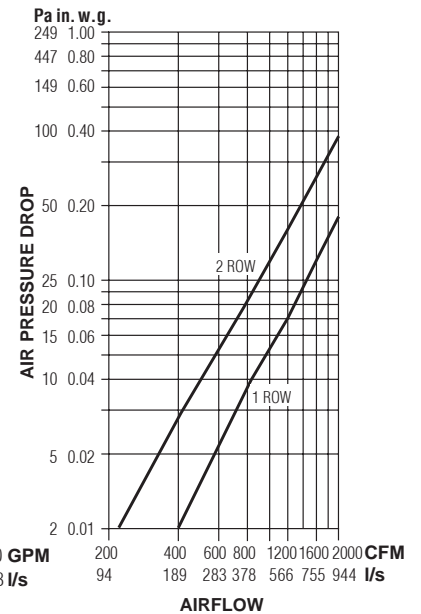

#### NOTES:

1. Capacities are in MBH (kW), *thousands of Btu per hour (kiloWatts)*.

2. MBH (kW) values are based on a  $\Delta t$  (temperature difference) of 120°F (67°C) between entering air and entering water. For other  $\Delta t$ 's; multiply the MBH (kW) values by the factors below.

3. Air Temperature Rise.

$$\text{ATR (}^\circ\text{F)} = 927 \times \frac{\text{MBH}}{\text{cfm}}, \text{ ATR (}^\circ\text{C)} = 829 \times \frac{\text{kW}}{\text{l/s}}$$

4. Water Temp. Drop.

$$\text{WTD (}^\circ\text{F)} = 2.04 \times \frac{\text{MBH}}{\text{GPM}}, \text{ WTD (}^\circ\text{C)} = .224 \times \frac{\text{kW}}{\text{l/s}}$$

5. Connections: 1 Row 1/2" (13) and 2 Row 7/8" (22); O.D. male solder.

#### Altitude Correction Factors:

Altitude ft. (m)	Sensible Heat Factor
0 (0)	1.00
2000 (610)	0.94
3000 (914)	0.90
4000 (1219)	0.87
5000 (1524)	0.84
6000 (1829)	0.81
7000 (2134)	0.78

#### Correction factors at other entering conditions:

$\Delta t$ °F (°C)	50 (28)	60 (33)	70 (39)	80 (44)	90 (50)	100 (56)	110 (61)	120 (67)	130 (72)	140 (78)	150 (83)
Factor	.417 (.418)	.500 (.493)	.583 (.582)	.667 (.657)	.750 (.746)	.833 (.836)	.917 (.910)	1.00 (1.00)	1.08 (1.08)	1.17 (1.16)	1.25 (1.24)

## Performance Data • Sensible Chilled Water Coil

Models: 33SZ, 33SZE, 33SZW • FPCWTU (DOAS) • Series Flow

Unit Size 40

2 Row (multi-circuit)

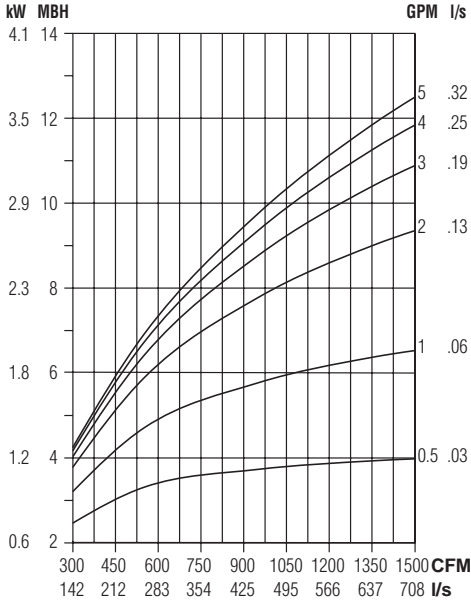

4 Row (multi-circuit)

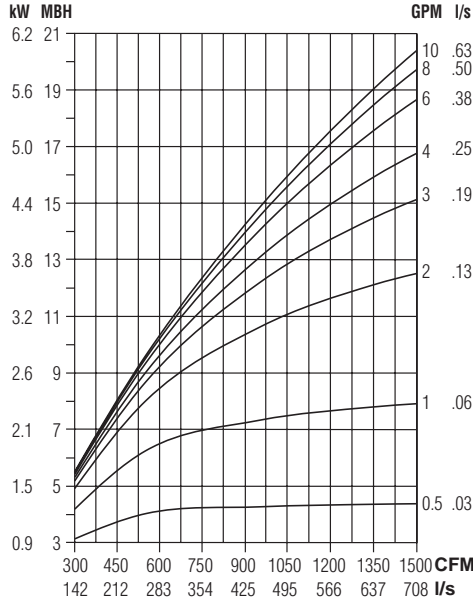

6 Row (multi-circuit)

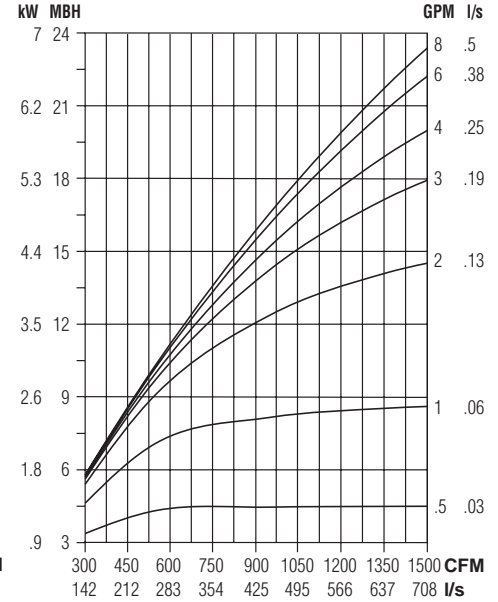

8 Row (multi-circuit)

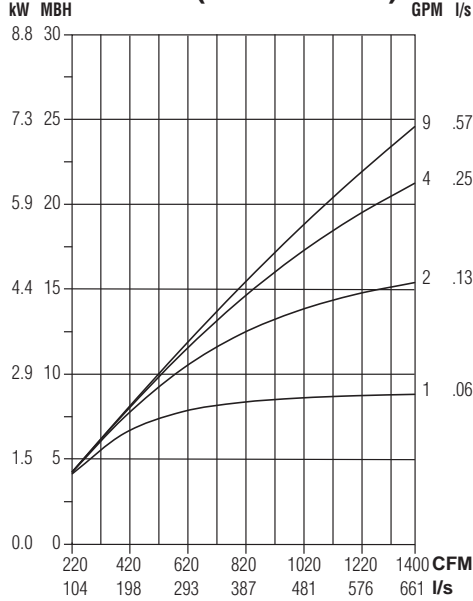

Water Pressure Drop

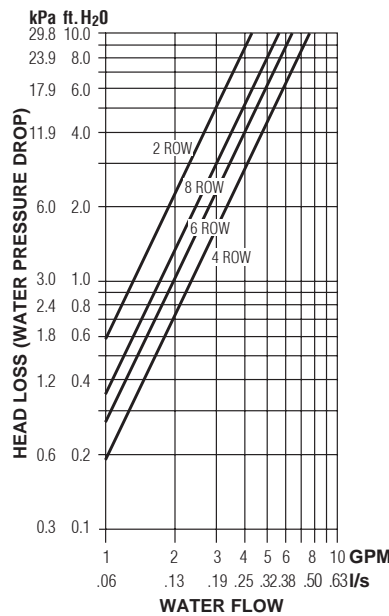

Air Pressure Drop

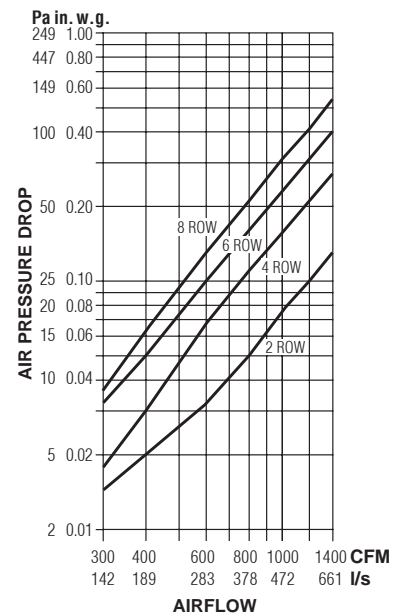

**NOTES:**

- Capacities are in MBH (kW), **thousands of Btu per hour (kiloWatts)**.
- MBH (kW) values are based on:  
57°F (32°C) Entering Water Temperature (EWT) and 75°F (42°C) Entering Air

Temperature (EAT). Entering water temperature must be above return air dew point to prevent condensation.

- Air Temperature Rise.

$$ATR (°F) = 927 \times \frac{MBH}{cfm}, ATR (°C) = 829 \times \frac{kW}{l/s}$$

- Water Temp. Drop.

$$WTD (°F) = 2.04 \times \frac{MBH}{GPM}, WTD (°C) = .224 \times \frac{kW}{l/s}$$

- Connections: 2, 4 & 6 Row: 7/8" (22) O.D. male solder.

**Altitude Correction Factors:**

Attitude (ft.)	0	1000	2000	3000	4000	5000	6000	7000
Air Density (lb./cu.ft.)	0.075	0.072	0.070	0.067	0.065	0.063	0.060	0.058
Sensible Capacity	1000	0.960	0.930	0.900	0.860	0.830	0.800	0.700

FAN POWERED TERMINAL UNITS



## Performance Data • Hot Water Coil

Model: 33SZW • FPCWTU (DOAS) • Series Flow

Unit Size 40

1 Row (single-circuit)

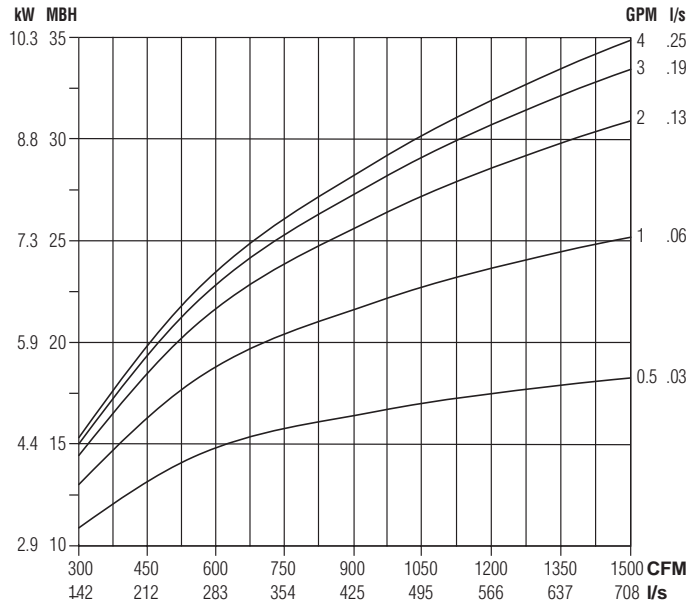

2 Row (multi-circuit)

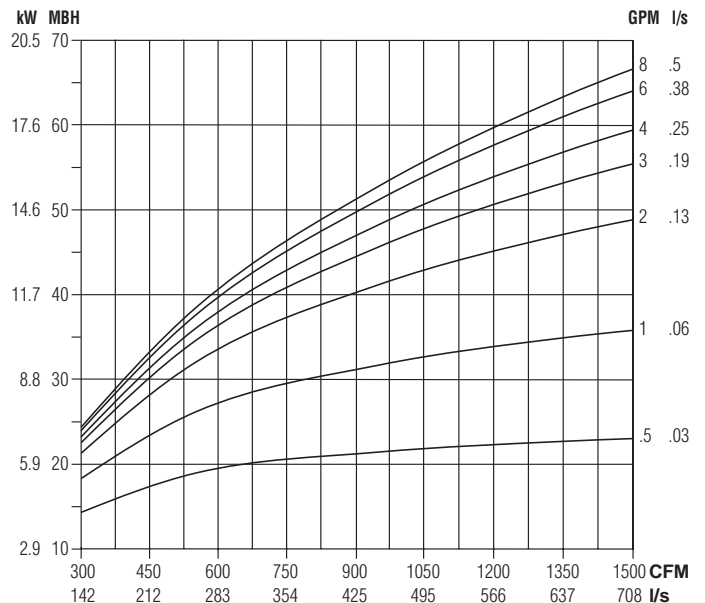

Water Pressure Drop

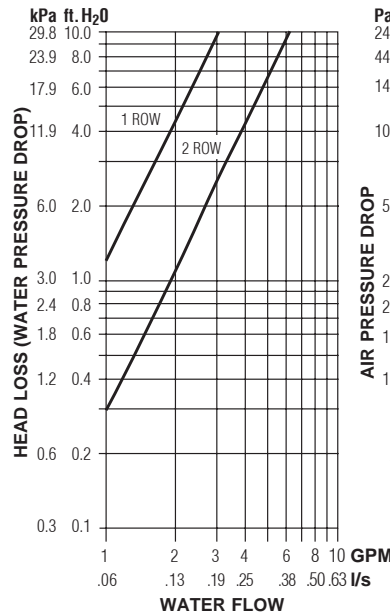

Air Pressure Drop

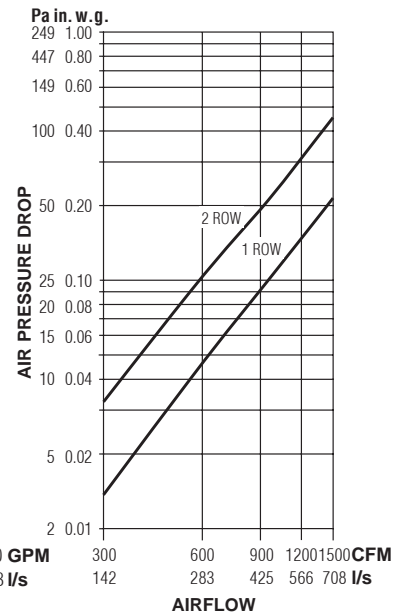

**NOTES:**

- Capacities are in MBH (kW), *thousands of Btu per hour (kiloWatts)*.
- MBH (kW) values are based on a  $\Delta t$  (temperature difference) of 120°F (67°C) between entering air and entering water. For other  $\Delta t$ 's; multiply the MBH (kW) values by the factors below.

- Air Temperature Rise.  
 $ATR (^\circ F) = 927 \times \frac{MBH}{cfm}$ ,  $ATR (^\circ C) = 829 \times \frac{kW}{l/s}$
- Water Temp. Drop.  
 $WTD (^\circ F) = 2.04 \times \frac{MBH}{GPM}$ ,  $WTD (^\circ C) = .224 \times \frac{kW}{l/s}$
- Connections: 1 Row 1/2" (13) and 2 Row 7/8" (22); O.D. male solder.

**Altitude Correction Factors:**

Altitude ft. (m)	Sensible Heat Factor
0 (0)	1.00
2000 (610)	0.94
3000 (914)	0.90
4000 (1219)	0.87
5000 (1524)	0.84
6000 (1829)	0.81
7000 (2134)	0.78

**Correction factors at other entering conditions:**

$\Delta t$ °F (°C)	50 (28)	60 (33)	70 (39)	80 (44)	90 (50)	100 (56)	110 (61)	120 (67)	130 (72)	140 (78)	150 (83)
Factor	.417 (.418)	.500 (.493)	.583 (.582)	.667 (.657)	.750 (.746)	.833 (.836)	.917 (.910)	1.00 (1.00)	1.08 (1.08)	1.17 (1.16)	1.25 (1.24)

FAN POWERED TERMINAL UNITS

## Performance Data • Sensible Chilled Water Coil

Models: 33SZ, 33SZE, 33SZW • FPCWTU (DOAS) • Series Flow

### Unit Size 50

2 Row (multi-circuit)

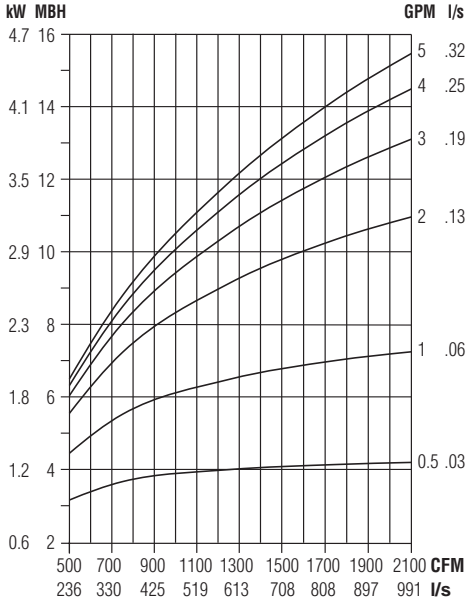

4 Row (multi-circuit)

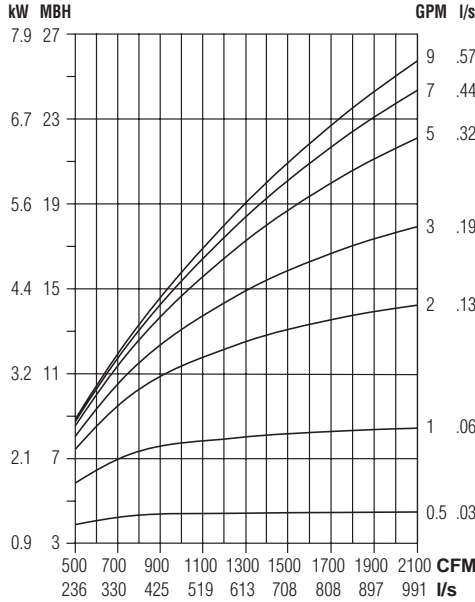

6 Row (multi-circuit)

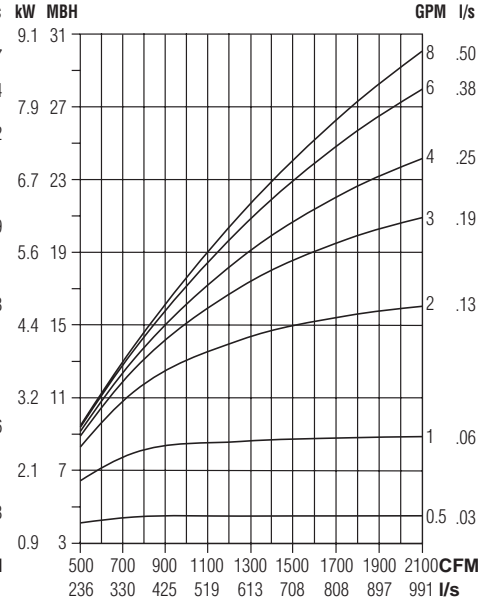

8 Row (multi-circuit)

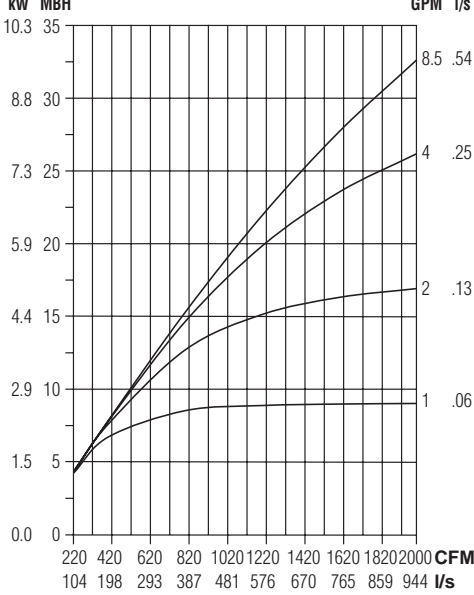

Water Pressure Drop

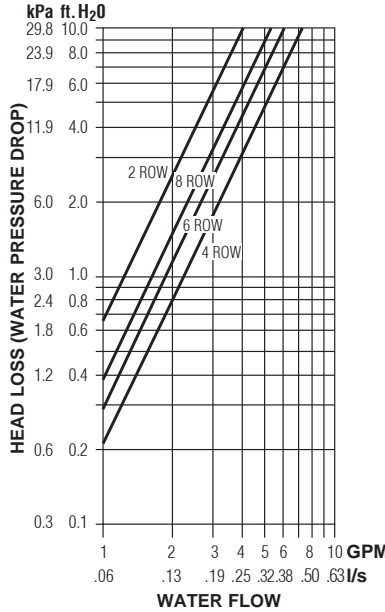

Air Pressure Drop

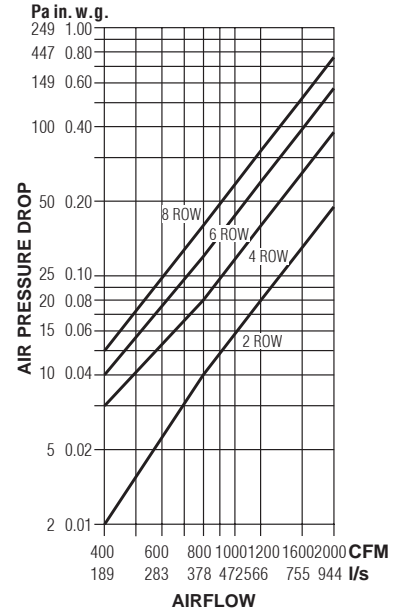

**NOTES:**

- Capacities are in MBH (kW), **thousands of Btu per hour (kiloWatts)**.
- MBH (kW) values are based on:  
57°F (32°C) Entering Water Temperature (EWT) and 75°F (42°C) Entering Air
- Air Temperature Rise.

Temperature (EAT). Entering water temperature must be above return air dew point to prevent condensation.

$$ATR (°F) = 927 \times \frac{MBH}{cfm}, \quad ATR (°C) = 829 \times \frac{kW}{l/s}$$

- Water Temp. Drop.

$$WTD (°F) = 2.04 \times \frac{MBH}{GPM}, \quad WTD (°C) = .224 \times \frac{kW}{l/s}$$

- Connections: 2, 4 & 6 Row: 7/8" (22) O.D. male solder.

**Altitude Correction Factors:**

Attitude (ft.)	0	1000	2000	3000	4000	5000	6000	7000
Air Density (lb./cu.ft.)	0.075	0.072	0.070	0.067	0.065	0.063	0.060	0.058
Sensible Capacity	1000	0.960	0.930	0.900	0.860	0.830	0.800	0.700

FAN POWERED TERMINAL UNITS

## Performance Data • Hot Water Coil

Model: 33SZW • FPCWTU (DOAS) • Series Flow

### Unit Size 50

#### 1 Row (multi-circuit)

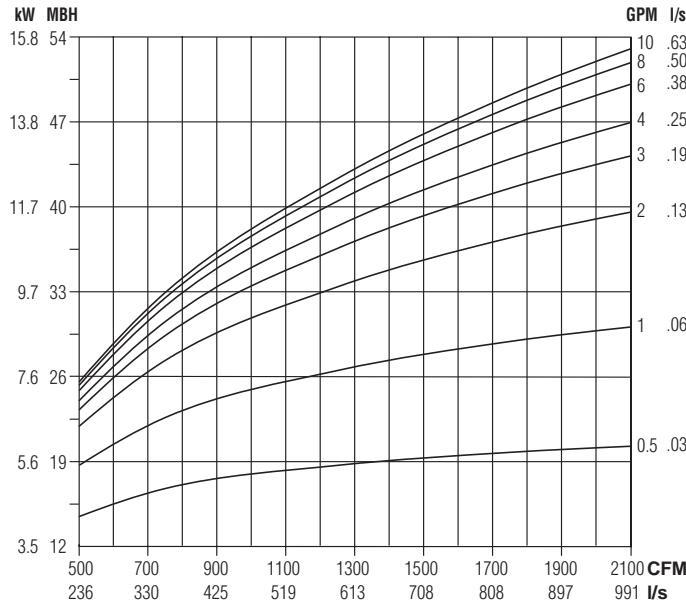

#### 2 Row (multi-circuit)

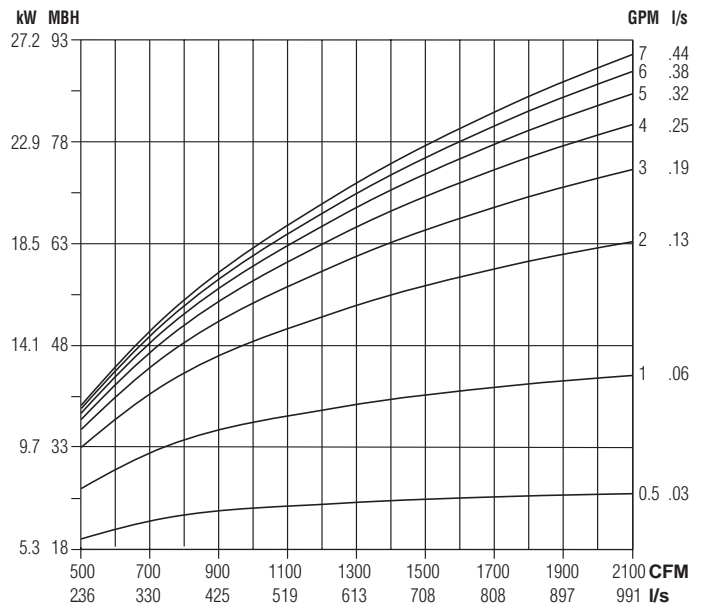

#### Water Pressure Drop

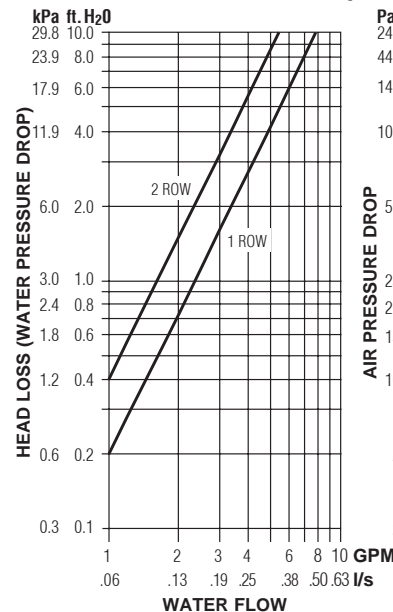

#### Air Pressure Drop

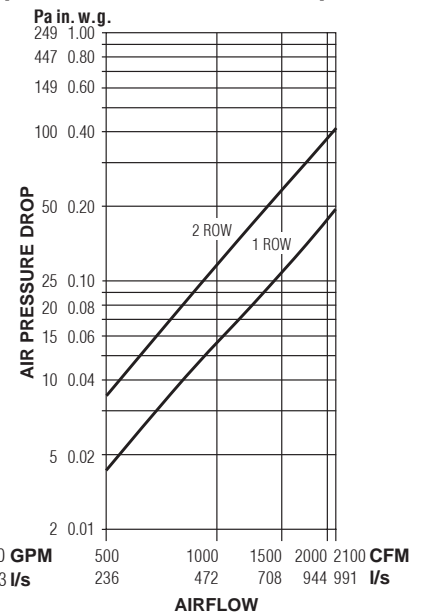

#### NOTES:

- Capacities are in MBH (kW), *thousands of Btu per hour (kiloWatts)*.
- MBH (kW) values are based on a  $\Delta t$  (temperature difference) of 120°F (67°C) between entering air and entering water. For other  $\Delta t$ 's; multiply the MBH (kW) values by the factors below.

- Air Temperature Rise.  
 $ATR (^\circ F) = 927 \times \frac{MBH}{cfm}$ ,  $ATR (^\circ C) = 829 \times \frac{kW}{I/s}$
- Water Temp. Drop.  
 $WTD (^\circ F) = 2.04 \times \frac{MBH}{GPM}$ ,  $WTD (^\circ C) = .224 \times \frac{kW}{I/s}$
- Connections: 1 Row 1/2" (13) and 2 Row 7/8" (22); O.D. male solder.

#### Altitude Correction Factors:

Altitude ft. (m)	Sensible Heat Factor
0 (0)	1.00
2000 (610)	0.94
3000 (914)	0.90
4000 (1219)	0.87
5000 (1524)	0.84
6000 (1829)	0.81
7000 (2134)	0.78

#### Correction factors at other entering conditions:

$\Delta t$ °F (°C)	50 (28)	60 (33)	70 (39)	80 (44)	90 (50)	100 (56)	110 (61)	120 (67)	130 (72)	140 (78)	150 (83)
Factor	.417 (.418)	.500 (.493)	.583 (.582)	.667 (.657)	.750 (.746)	.833 (.836)	.917 (.910)	1.00 (1.00)	1.08 (1.08)	1.17 (1.16)	1.25 (1.24)

## Performance Data • Sensible Chilled Water Coil

Models: 33SZ, 33SZE, 33SZW • FPCWTU (DOAS) • Series Flow

### Unit Size 55

2 Row (multi-circuit)

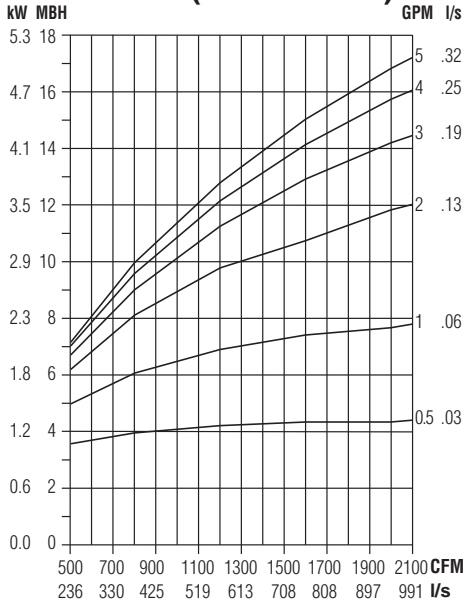

4 Row (multi-circuit)

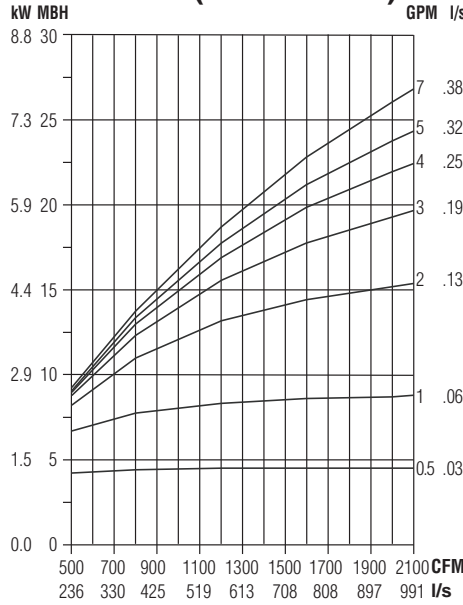

6 Row (multi-circuit)

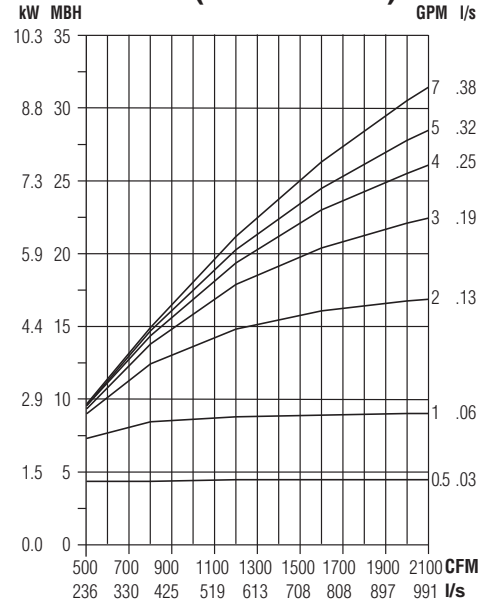

8 Row (multi-circuit)

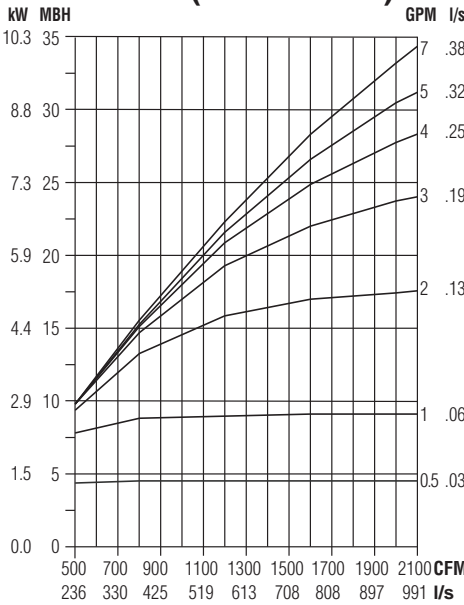

Water Pressure Drop

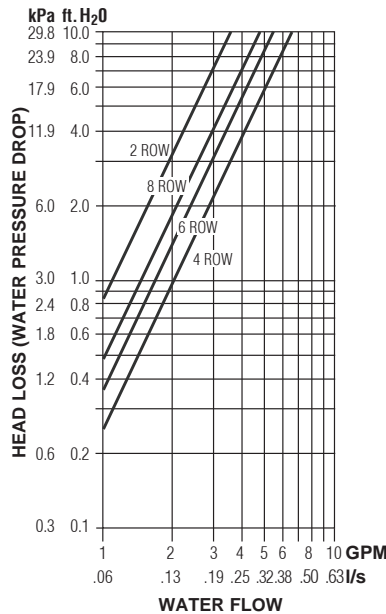

Air Pressure Drop

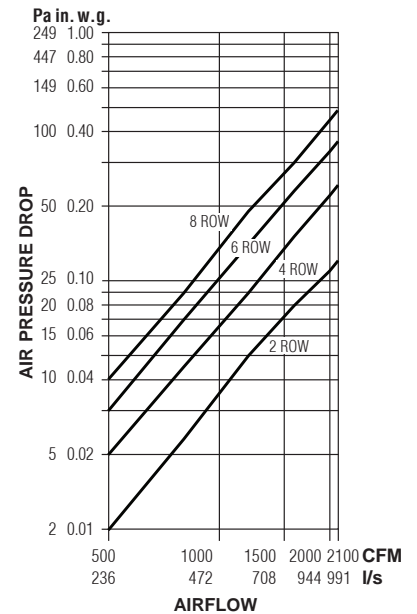

**NOTES:**

- Capacities are in MBH (kW), **thousands of Btu per hour (kiloWatts)**.
- MBH (kW) values are based on:  
57°F (32°C) Entering Water Temperature (EWT) and 75°F (42°C) Entering Air
- Air Temperature Rise.  
 $ATR (°F) = 927 \times \frac{MBH}{cfm}$ ,  $ATR (°C) = 829 \times \frac{kW}{l/s}$

Temperature (EAT). Entering water temperature must be above return air dew point to prevent condensation.

- Water Temp. Drop.  
 $WTD (°F) = 2.04 \times \frac{MBH}{GPM}$ ,  $WTD (°C) = .224 \times \frac{kW}{l/s}$
- Connections: 2, 4, 6 & 8 Row: 7/8" (22) O.D. male solder.

**Altitude Correction Factors:**

Attitude (ft.)	0	1000	2000	3000	4000	5000	6000	7000
Air Density (lb./cu.ft.)	0.075	0.072	0.070	0.067	0.065	0.063	0.060	0.058
Sensible Capacity	1000	0.960	0.930	0.900	0.860	0.830	0.800	0.700

FAN POWERED TERMINAL UNITS



## Performance Data • Hot Water Coil

Model: 33SZW • FPCWTU (DOAS) • Series Flow

### Unit Size 55

#### 1 Row (multi-circuit)

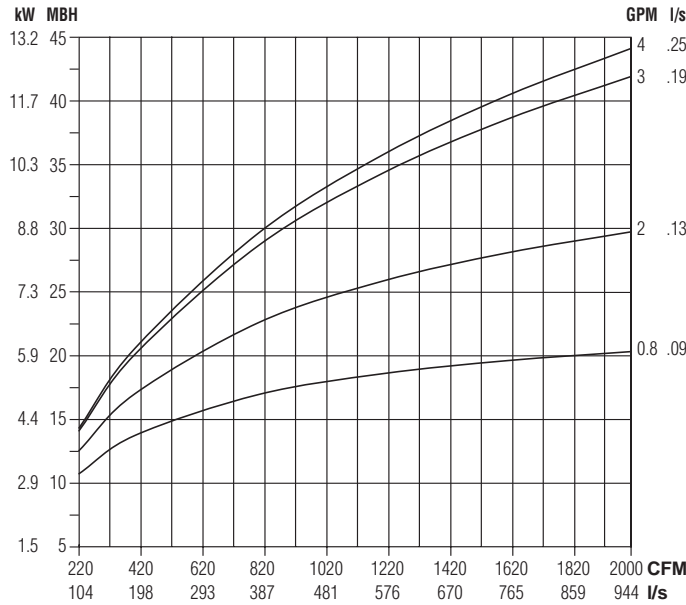

#### 2 Row (multi-circuit)

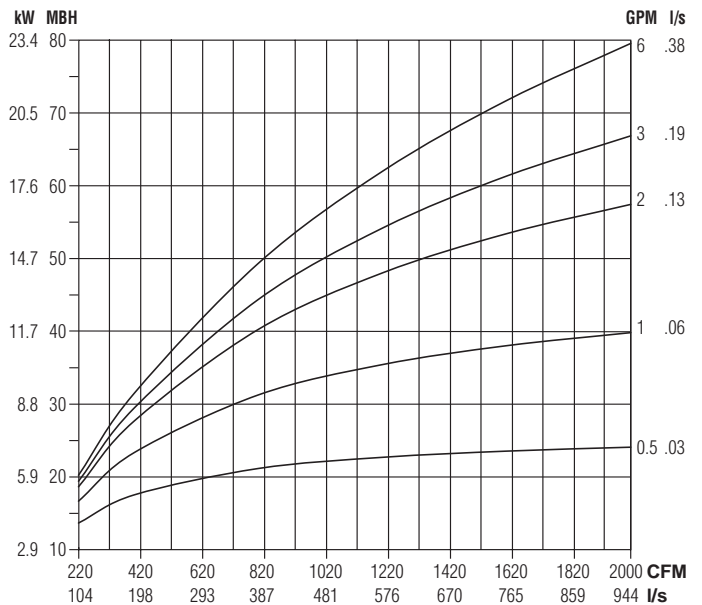

#### Water Pressure Drop

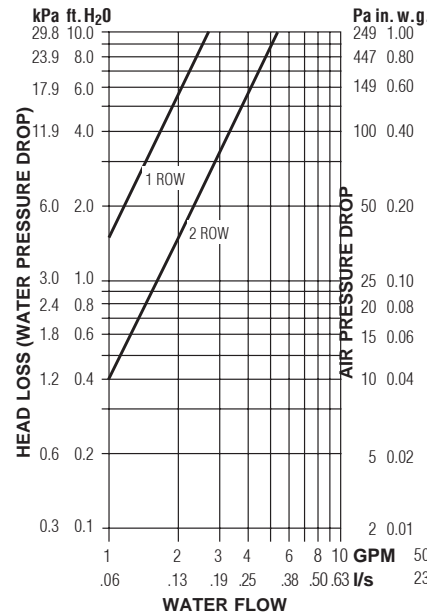

#### Air Pressure Drop

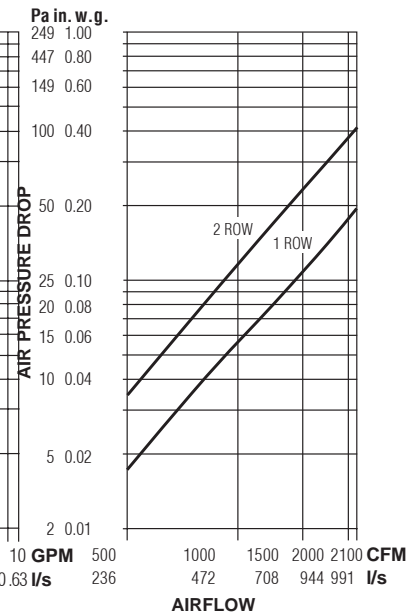

#### NOTES:

- Capacities are in MBH (kW), *thousands of Btu per hour (kiloWatts)*.
- MBH (kW) values are based on a  $\Delta t$  (temperature difference) of 120°F (67°C) between entering air and entering water. For other  $\Delta t$ 's; multiply the MBH (kW) values by the factors below.

- Air Temperature Rise.  
 $ATR (^\circ F) = 927 \times \frac{MBH}{cfm}$ ,  $ATR (^\circ C) = 829 \times \frac{kW}{l/s}$
- Water Temp. Drop.  
 $WTD (^\circ F) = 2.04 \times \frac{MBH}{GPM}$ ,  $WTD (^\circ C) = .224 \times \frac{kW}{l/s}$
- Connections: 1 Row 1/2" (13) and 2 Row 7/8" (22); O.D. male solder.

#### Altitude Correction Factors:

Altitude ft. (m)	Sensible Heat Factor
0 (0)	1.00
2000 (610)	0.94
3000 (914)	0.90
4000 (1219)	0.87
5000 (1524)	0.84
6000 (1829)	0.81
7000 (2134)	0.78

#### Correction factors at other entering conditions:

$\Delta t$ °F (°C)	50 (28)	60 (33)	70 (39)	80 (44)	90 (50)	100 (56)	110 (61)	120 (67)	130 (72)	140 (78)	150 (83)
Factor	.417 (.418)	.500 (.493)	.583 (.582)	.667 (.657)	.750 (.746)	.833 (.836)	.917 (.910)	1.00 (1.00)	1.08 (1.08)	1.17 (1.16)	1.25 (1.24)

## Recommended Primary Valve Airflow Ranges For All Fan Powered Terminal Units

The recommended airflow ranges below are for fan powered terminal units with pressure independent controls and are presented as ranges for total and controller specific minimum and maximum airflow. Airflow ranges are based upon maintaining reasonable sound levels and controller limits using Nailor's Diamond Flow Sensor as the airflow measuring device. For a given unit size, the minimum, auxiliary and the maximum flow setting must be within the range limits to ensure pressure independent operation, accuracy and repeatability.

Minimum airflow limits are based upon .02" w.g. (5 Pa) differential pressure signal from Diamond Flow Sensor on analog/digital controls and .03" (7.5) for pneumatic controllers. This is a realistic low limit for many transducers used in the digital controls industry. Check your controls supplier for minimum limits. Setting airflow minimums lower, may cause hunting and failure to meet minimum ventilation requirements.

The high end of the tabulated Total Airflow Range on pneumatic and analog electronic controls represents the Diamond Flow Sensor's differential pressure reading at 1" w.g. (249 Pa). The high end airflow range for digital controls is represented by the indicated transducer differential pressure.

ASHRAE 130 "Performance Rating of Air Terminals" is the method of test for the certification program. The "standard rating condition" (certification rating point) airflow volumes for each terminal unit size are tabulated below per AHRI Standard 880. These air volumes equate to an approximate inlet velocity of 2000 fpm (10.2 m/s).

When digital or other controls are mounted by Nailor, but supplied by others, these values are guidelines only, based upon experience with the majority of controls currently available. Controls supplied by others for factory mounting are configured and calibrated in the field. Airflow settings on pneumatic and analog controls supplied by Nailor are factory preset when provided.

### Imperial Units, Cubic Feet per Minute

Inlet Size	Inlet Type	Total Airflow Range, cfm	Airflow at 2000 fpm Inlet Velocity (nom.), cfm	Range of Minimum and Maximum Settings, cfm							
				Pneumatic 3000 Controller		Analog Electronic Controls		Digital Controls			
						Transducer Differential Pressure ( w.g.)					
				Min.	Max.	Min.	Max.	Min.	Max.	Max.	
.03	1.0	.02	1.0	.02	1.0	1.25	≥ 1.5				
4	Round	0 – 225	150	30	180	25	180	25	180	200	225
5		0 – 400	250	55	325	45	325	45	325	360	400
6		0 – 550	400	80	450	65	450	65	450	500	550
7		0 – 800	550	115	650	95	650	95	650	725	800
8		0 – 1100	700	155	900	125	900	125	900	1000	1100
10		0 – 1840	1100	260	1500	215	1500	215	1500	1675	1840
12		0 – 2500	1600	355	2050	290	2050	290	2050	2290	2500
14		0 – 3370	2100	475	2750	390	2750	390	2750	3075	3370
16		0 – 4510	2800	640	3700	520	3700	520	3700	4120	4510
12		Flat Oval	0 – 2500	1600	355	2050	290	2050	290	2050	2300
14	0 – 3125		2100	440	2550	360	2550	360	2550	2850	3125
16	0 – 3725		2800	525	3040	430	3040	430	3040	3400	3725
18	0 – 5265		3500	750	4300	610	4300	610	4300	4800	5265
14 x 8	Rect.	0 – 2450	1560	350	2000	290	2000	290	2000	2240	2450
14 x 10		0 – 2950	1900	420	2400	340	2400	340	2400	2700	2950

### Metric Units, Liters per Second

Inlet Size	Inlet Type	Total Airflow Range, l/s	Airflow at 10.2 m/s Inlet Velocity (nom.), l/s	Range of Minimum and Maximum Settings, l/s							
				Pneumatic 3000 Controller		Analog Electronic Controls		Digital Controls			
						Transducer Differential Pressure ( Pa )					
				Min.	Max.	Min.	Max.	Min.	Max.		
7.5	249	5	249	5	249	311	≥ 374				
4	Round	0 – 106	71	14	85	12	85	12	85	94	106
5		0 – 189	118	26	153	21	153	21	153	170	189
6		0 – 260	189	38	212	31	212	31	212	236	260
7		0 – 378	260	54	307	45	307	45	307	342	378
8		0 – 519	330	73	425	59	425	59	425	472	519
10		0 – 868	519	123	708	101	708	101	708	790	868
12		0 – 1180	755	168	967	137	967	137	967	1081	1080
14		0 – 1590	991	224	1298	184	1298	184	1298	1451	1590
16		0 – 2128	1321	302	1746	245	1746	245	1746	1944	2128
12		Flat Oval	0 – 1180	755	168	967	137	967	137	967	1085
14	0 – 1475		991	208	1203	170	1203	170	1203	1345	1475
16	0 – 1758		1321	248	1435	203	1435	203	1435	1604	1758
18	0 – 2485		1652	354	2029	288	2029	288	2029	2265	2485
14 x 8	Rect.	0 – 1156	736	165	944	137	944	137	944	1057	1156
14 x 10		0 – 1392	897	198	1133	160	1133	160	1133	1274	1392