

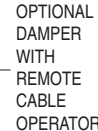

LAMINAR FLOW CEILING DIFFUSER
ALUMINUM HYBRID • CRITICAL ENVIRONMENT
APPLICATIONS • LOW CAPACITY DESIGN
HEPA OR ULPA FILTER • DOP SCAN TESTED
MODEL: 92LDFDS-AL

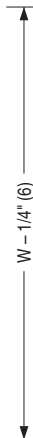

TYPE S Surface Mount Detail

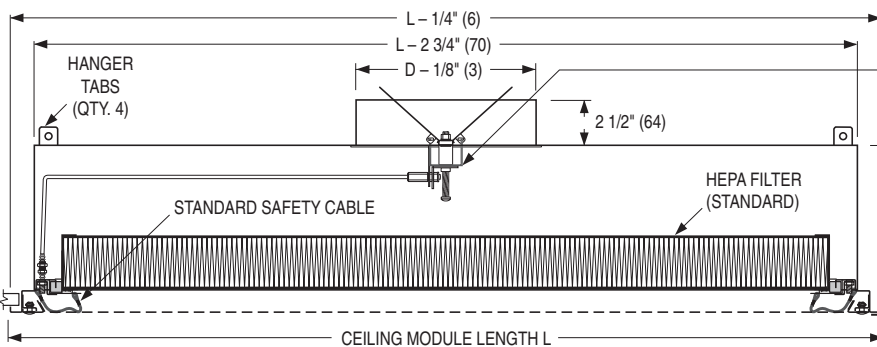
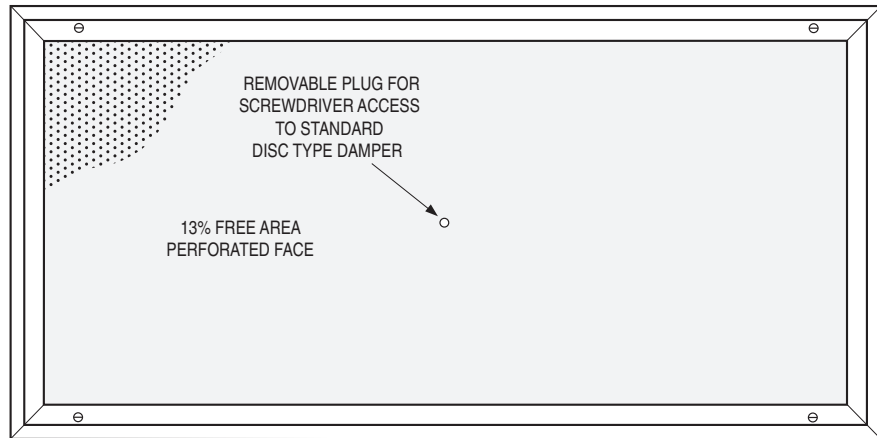
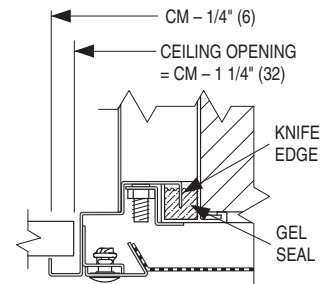

TYPE L* Lay-in T-Bar Detail

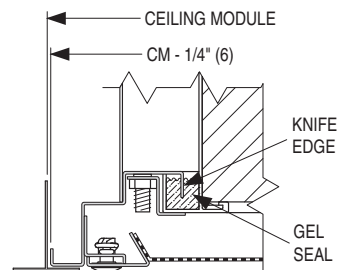

* COMPATIBLE WITH T-BARS UP TO 1 1/2" (38) WIDE

Optional Static Pressure Port

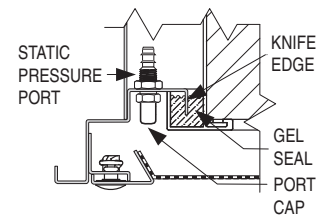

Ceiling Module Sizes L x W & Nominal Round Duct Sizes D

L x W	Imperial Modules (inches)	48 x 12	60 x 12	24 x 24	36 x 24	48 x 24	60 x 24
	Metric Modules (mm)	1200 x 300	1500 x 300	600 x 600	900 x 600	1200 x 600	1500 x 600
Duct Size D	(inches)	6, 7, 8	6, 7, 8	6, 7, 8	6, 7, 8, 10	7, 8, 10, 12	10, 12
	(mm)	152, 178, 203	152, 178, 203	152, 178, 203	152, 178, 203, 254	178, 203, 254, 305	254, 305

DESCRIPTION:

The Model 92LDFDS-AL Laminar Flow Diffuser is a low capacity/airflow range design that produces a non-aspirating, low velocity vertical air pattern. Recommended face velocity is 20 – 60 cfm/sq. ft. Incorporating an extended plenum and a unique frame they are designed to accommodate a Gel Seal HEPA or ULPA filter. The filters can be easily removed and replaced from the face of the unit. Installed above the operating table in a hospital operating room, the 'clean' conditioned air flows over the operating table so helping to protect and effectively isolate the patient from contaminated air. The installed HEPA or ULPA filter equalizes air distribution across the perforated face resulting in excellent performance. The plenum is factory DOP scan tested for leaks in accordance with Standard IEST-RP-CCO34.3. The only significant amount of room air entrainment occurs at the outer boundary of the laminar flow mass, outside the confines of the operating table. Other applications include clean rooms such as research laboratories, animal labs, food processing, pharmaceutical labs and computer rooms where localized heavy cooling loads present a problem.

CONSTRUCTION:

- 304 stainless steel frame and aluminum perforated face with 3/32" (2.4) dia. holes on 60 degree 1/4" (6) staggered centers (13% free area). The face plate is removable for cleaning and is secured by 1/4 turn fasteners.
- 304 stainless steel fully welded plenum and face operated disc type damper.
- Standard safety cables prevent accidental dropping of removable face.
- HEPA Filter: Clear anodized extruded aluminum filter frame with port for damper adjustment.
- Standard finish is AW Appliance White.

OPTIONS AND ACCESSORIES:

- UL ULPA Filter (99.9995% on 0.12 μm).
- FBO Filter by others.
- BDS Butterfly damper, Stainless Steel (face operated).
- BDSR Butterfly damper, Stainless Steel with remote cable operator.
- RDS Radial opposed blade damper, Stainless Steel (face operated).
- RDSR Radial OBD, Stainless Steel with remote cable operator.
- EX External foil-back insulation (installed) – R-4.2.
- SPP Static pressure test/DOP port.
- CPM DOP/PAO Challenge Port and Manifold.
- LFI LED Loaded Filter Indicator.
- STC Scan Testing Certificate.
- SP Special Finish _____.
- PDB Perforated Diffusion Basket.

SCHEDULE TYPE:

PROJECT:

ENGINEER:

CONTRACTOR:

Dimensions are in inches (mm).

DATE

B SERIES

SUPERSEDES

DRAWING NO.

7 - 17 - 17

9200

1 - 5 - 16

92LDFDS-AL