

GENERAL PRODUCT OVERVIEW

Leading The Industry

Providing products that incorporate the desires and requirements of the industry we serve has traditionally been a primary focus at Nailor.

We listened in-depth to the engineering and contracting community, asked a lot of questions and realized there was not a single line of fan powered terminals available that incorporated all the design features and performance criteria that satisfied their wishes.

After an extensive and intense period of research, design and development, we have produced a line of fan powered terminals that satisfy the vast majority of requirements the HVAC industry demands.

On the next page, you can see at a glance some of the unique universal features that have been incorporated into Nailor fan powered terminals, providing the benefits of high performance operation and many field-friendly features to aid installation.

All Nailor terminals include the following additional features as standard:

- Compatibility with digital, analog electronic and pneumatic controls.
- Fan motors and heaters are energized and dielectric tests are performed on every terminal to ensure correct operation prior to shipment.
- Custom fabricated motor/blower combinations are mounted on special heavy gauge angles and isolated from casing with rubber insulators.
- All motors incorporate an anti-backward rotation design to prevent backward rotation upon start-up.
- Units can be flipped in the field for right or left hand configuration except Model Series 33SZ.



Model Series 33SZ. Basic Unit
Chilled Water, Series Flow, (Constant or Variable Volume)



Model Series 37SE, Electric Heat
Series Flow (Constant or Variable Volume)



Model Series 37SST Stealth™, Hot Water Heat
Super Quiet, Series Flow (Constant or Variable Volume)

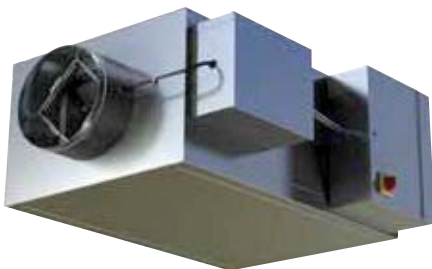

Model Series 35S. Basic Unit
Series Flow (Constant or Variable Volume)



Model Series 35NW, Hot Water Heat
Compact Design, Parallel Flow (Variable Volume)



Model Series 35SST Stealth™, Hot Water Heat
Super Quiet, Series Flow (Constant or Variable Volume)



Model Series 37NW, Hot Water Heat
Low Profile Design, Parallel Flow (Variable Volume)

Design Characteristics and Application

Introduction

Fan Powered Terminal Units are an economical means of both cooling and periodically heating the perimeter zones of a building utilizing a single duct control system. In addition to inherent VAV economies, fan terminals utilize the free heat derived from lighting, people and other equipment and induce this warmer plenum air from the building core ceiling plenum space and re-circulate it to rooms calling for heating. If additional heating is required, optional supplementary heating coils may be activated. The need for a central source of warm air is eliminated.

During weekend or night-time operation, the central fans may be turned off. Heat, if required, may be provided by the terminal unit fan itself.

Fan Powered Terminal Units are the most popular design for office buildings because they provide performance benefits by reducing first cost, (such as lower central system fan HP and smaller ductwork), lower operating cost, the recovery of waste heat, and the capacity for improved air circulation and diffuser performance.

Fan terminals are available in two basic configurations; series or parallel flow. Each contains a fan motor assembly and a variable air volume damper to modulate primary air.

In a series unit (Fig. 1), the fan sits in the primary air stream and runs constantly when the zone is occupied. In a parallel unit (Fig. 2), the fan sits outside the primary air stream and runs intermittently.

Although both terminals can provide central fan HP savings, each terminal has different inlet static pressure requirements. Series fan terminals boost both induced air and primary air, so the inlet static pressure only needs to overcome the loss across the damper [less than 0.05" w.g. (12 Pa)] with Nailor terminals. Parallel fan terminals require enough static pressure to overcome the losses across the damper, the downstream ductwork and diffusers [typically 0.25 — 0.5" w.g. (62 — 124 Pa)] with Nailor terminals.

Series Flow Terminals – (Constant Volume)

A series fan powered terminal unit mixes primary air with induced plenum air by using a continuously operating fan during the occupied mode. It provides a constant volume of air to the space regardless of load.

As the cooling load decreases, the zone thermostat throttles the primary air valve. The terminal fan makes up the difference by inducing more return air from the plenum. At low cooling loads, the primary air may close or go to a minimum ventilation setting. If the zone temperature drops still further, the thermostat can energize optional supplemental heat. The sequence reverses when the load is increased.

The series terminal is therefore a constant volume, variable temperature unit. (See Fig. 3).

Series units should only be used with pressure independent controls. Series fans must be adjusted to match the maximum cooling cfm, to ensure that the primary air does not exceed

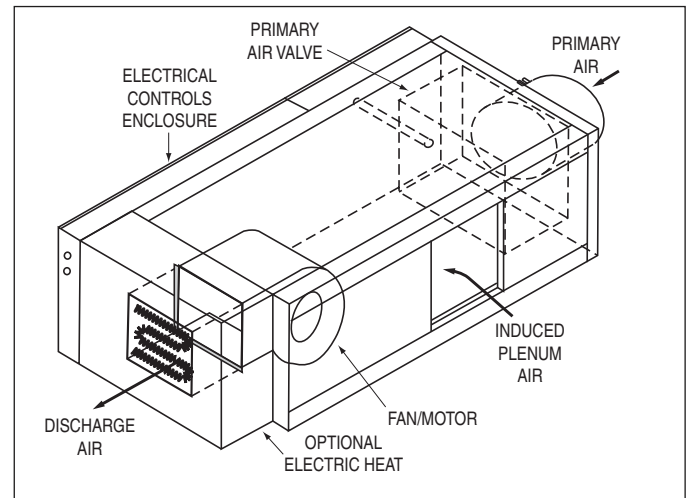

Figure 1. Series Fan Terminal

the fan cfm as this would result in the short-circuiting of primary air directly into the ceiling plenum and waste energy. A pressure independent controller and inlet flow sensor controls the primary air valve to compensate for changes in inlet static pressure and ensures design cfm is maintained.

Parallel Flow Terminals – (Variable Volume)

Also called an intermittent fan terminal unit, a parallel unit modulates primary air in response to cooling demand and energizes the integral fan in sequence to deliver induced air to meet heating demand. The induction fan operating range should slightly overlap the range of the primary air valve. A backdraft damper ahead of the terminal fan restricts conditioned air from escaping into the return air plenum when the fan is off.

During full cooling demand, the thermostat positions the primary air valve for full airflow while the fan is de-energized. As the cooling load decreases, less primary air is delivered to the zone as the thermostat modulates the valve (functioning as a single duct VAV terminal).

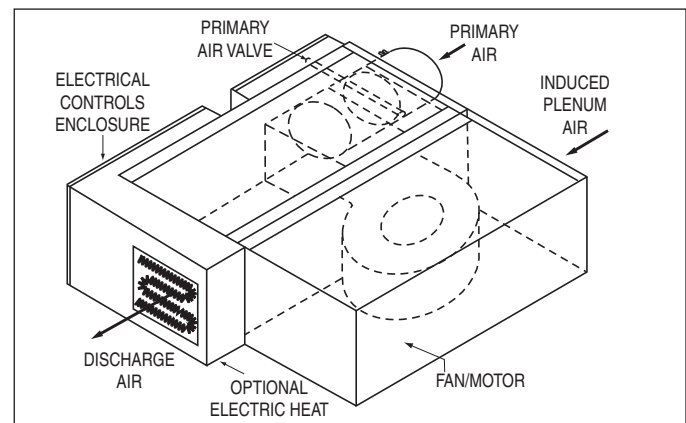

Figure 2. Parallel Fan Terminal

Common Fan Terminal Components

The Diamond Flow multi-point averaging sensor is standard on all Nailor terminal units that are equipped with pressure independent controls.

In addition to the Diamond Flow multi-point averaging sensor and opposed blade damper configuration of the primary air valve that are described in detail on page O11 in this catalog, all Nailor fan powered terminals incorporate the following features and benefits.

Single Speed PSC Induction Motors

All Nailor fan powered terminal units are currently equipped with single speed, direct drive, fractional horsepower, high efficiency, PSC motors as standard. These motors are manufactured to specifications developed by Nailor specifically for the fan powered terminal unit market. Some of the more important features of PSC motors are listed and explained below.

- **No Corona Effect**

Motors not only provide power, but act as transformers and generators. Under certain conditions, this causes the unused speed taps in multiple speed motors to have large potential or static charges present. While these charges are not doing any work, they will create damage to the windings if their potential voltages are greater than the winding insulating quality. This is often the case and lifetimes are shortened. Nailor fan powered terminal units do not suffer from this malady. All motors are single speed.

- **Wide Operating Ranges**

Nailor motors are designed to operate at rotational speeds lower than those of our competitors. This requires special stator wire sizing, special capacitor sizing and special bearings. These items are covered in our specifications. This assures you of high end performance equal to or better than any of our competitors and low end ranges below any of our competitors.

Low end performance is often ignored. Many times, this is because the range is not great enough to allow much difference, or because the low end performance is achieved by artificial means such as manual dampers to lower the airflows. Manual dampers lower airflows, but they increase RPM. Increased RPM puts back all the noise generated in the fan powered terminal unit as if it were still operating at full airflow. This is due to the noise caused by tip speed and vibration within the unit. High RPM, regardless of airflow will generate high noise.

Nailor solves this problem through low RPM for low airflows. Typically, the motors in Nailor fan powered terminal units can rotate as low as 350 RPM at low end, shedding as many as 14 to 20 decibels in the second and third octave bands depending on which unit is being selected. This means real sound level selections, units that can produce NC's of 30 and 35 when applied correctly and wider operating ranges on individual units for greater flexibility in the zone.

- **Permanently Lubricated Motors**

Nailor fan powered terminal units are equipped with permanently lubricated motors. The motors are equipped with oilers, but the oilers are not necessary as long as the units are operated in typical ambient temperature conditions. The specifications call for the oil reservoirs to have at least 50% of the original oil still in the reservoir after 50,000 hours of use under normal conditions.

- **Permanent Split Capacitor Design**

All Nailor fan powered terminal units are supplied with PSC motors as standard. The capacitors are sized to provide ample starting torque, even when turned down to the low minimums allowed on Nailor fan powered terminal units.

- **High Efficiency**

All Nailor PSC motors have the highest efficiency available in the market today. This too, is controlled by the Nailor motor specifications. Higher efficiency means lower operating expenses.

PSC Fan Speed Controllers

Nailor designed its own solid state fan speed controllers. They are designed to operate with the specific motor and blower combinations as used in Nailor fan powered terminal units. They provide smooth and infinite adjustment of motor speed from maximum to the lowest preset low end limits found in the industry.

The speed controllers are largely responsible for the operating ranges of the motors. High quality standards allow very accurate low end stops. This assures Nailor customers of sound levels and performance as cataloged.

The matching of the motors and speed controllers allows Nailor fan powered terminal units lower watt consumption as motor RPM's are reduced. High efficiency is maintained from high end performance to low end performance. Very few of our competitors can make a similar claim.

Low Noise Levels – AHRI Certified

In addition to those items listed above, Nailor holds down noise levels in the occupied space with heavy gauge metal casings, dual density insulation and multiple isolation points between motors and casings. Nailor is as quiet as any and far quieter than most of our competitors when controlling similar airflows on competitive equipment. Check out the sound data in this catalog. Notice there is no fine print covering the conditions under which the data does not apply. Notice that the minimum static requirement on series fan powered terminal units is 0.05" w.g. (12 Pa). Then notice the correspondingly low inlet static pressures on the parallel units. Notice that Nailor sound data is AHRI certified and independently certified by Energistics Laboratory, Houston. Compare that to the competition.

ECM/EPIC FAN TECHNOLOGY®

- Significant energy savings (67% typical compared to PSC motors)
- Unique factory pre-set air volume capability (+/- 5%)
- Pressure independent fan operation
- LED for visual indication of air volume
- Field adjustable fan air volume controller
- Remote fan air volume adjustment capability from BAS
- Larger turn down ratios mean more flexibility for tenant changes



Since 1985, equipment manufacturers have used ECM's in residential air conditioners and furnaces. These motors have made it possible to achieve SEER ratings of 12 and higher. Nailor first introduced the ECM to the commercial HVAC market (ASHRAE Journal, April 1997) as an option for use in series fan powered terminal unit applications.

WHAT IS AN ECM?

The ECM (Electronically Commutated Motor) is an ultra high efficiency programmable brushless DC motor utilizing a permanent magnet motor and a built-in AC/DC converter. DC motors are significantly more energy efficient than AC motors and much easier to control. The major weakness of series fan powered terminal units until now, has been their low fan motor efficiency. The widely used single speed fractional horsepower PSC (Permanent Split Capacitor) induction motor in combination with an electronic SCR speed controller is extremely inefficient at typical operating conditions. Due to acoustical considerations, the fan motor is usually adjusted to operate at considerably less than full load (where PSC motor efficiencies may be as high as 62%). PSC motor efficiency drops off dramatically when turned down; typically by at least half. Installed PSC motor efficiencies are therefore typically in the range of only 12 – 45%. ECM's in contrast, maintain a high efficiency of 78 – 83% at all speeds.

In addition to lower operating costs, ECM / EPIC Fan Technology® allows Nailor to pre-set the fan airflow volume at the factory for constant volume units or modulate the fan across wide ranges as zone loads change.

Figure 1. shows the lower watts per cfm translating into lower operating costs as shown on Figure 2, and wider operating ranges of series terminals employing ECM versus PSC induction motors.

FEATURES AND BENEFITS OF ECM

Soft starts and slewed speed ramps are programmed into the ECM eliminating stress transmitted to the mounting bracket or hardware. They incorporate ball bearings providing permanent lubrication unlike sleeve bearings requiring a minimum RPM operation for oiling. The wider operating range of the ECM allows much more flexibility in zone applications. This feature alone provides several benefits; a simpler product line to choose from, little or no equipment changes

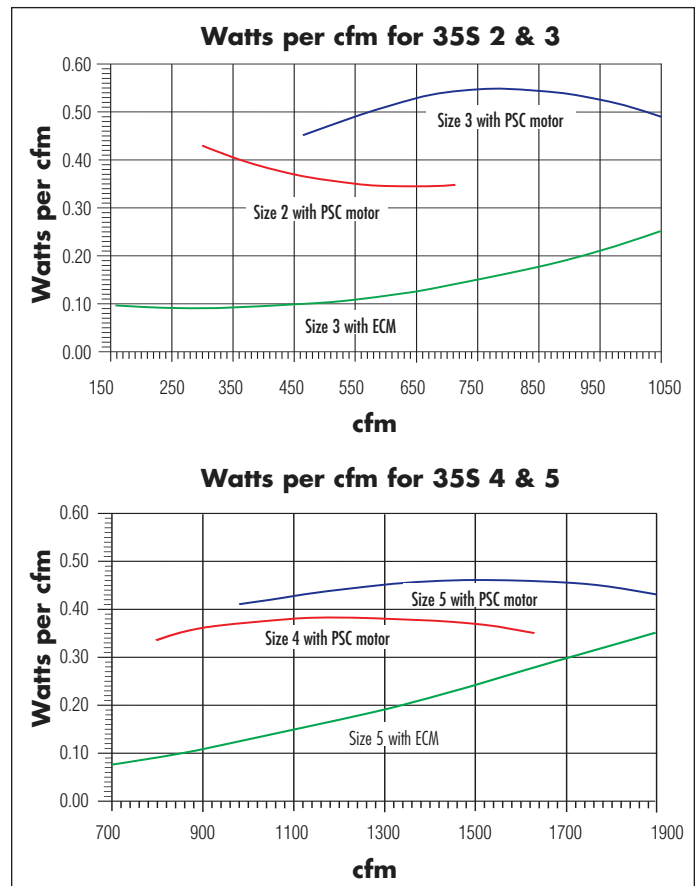

Figure 1. Power consumption comparison of ECM versus PSC motors.

necessary when tenants change, more similar sized units on the job, decreased spare parts inventory and increased contractor flexibility. The low operating temperature of the ECM motor (essentially ambient) requires very little energy to offset the heat gain from the motor.

ECM/EPIC FAN TECHNOLOGY®

These features also extend the life of the ECM, which are expected to provide an average 90,000 hours of operation. This translates into about 25 years for a typical series fan powered terminal unit. In addition to these standard features are two primary benefits; energy savings and the ability to pre-set the fan airflow volume at the factory.

HOW DO YOU PRE-SET FAN AIRFLOW?

Pre-setting the fan airflow (cfm) has always been a problem for fan powered terminal manufacturers for two major reasons. First is that AC motors are not synchronous machines and second the RPM and consequently the unit cfm, changes when static pressure changes. The difficulty in pre-setting the fan lies in estimating the motor workload required at the job site in actual working conditions. The fan will not produce the same volume of air as it did at the factory without the duct work. Because there is no way to accurately predict the downstream static pressure as it would exist at the job site, it was impossible to pre-set the fan cfm. The ECM's are DC and inherently synchronous machines. The motors are programmed to calculate the work they are doing and then compare the work accomplished to the cfm requirement. The integral microprocessor based controller automatically adjusts the speed and torque in response to system pressure changes and pressure independent constant airflow operation is achieved without the need for an external flow sensor feedback loop.

Nailor series fan powered terminal units incorporate our own custom EPIC fan controller. An electronic PWM volume control device that allows adjustment of airflow volume. This value can be pre-set on the assembly line. It is field adjustable either manually using a screwdriver and voltmeter locally at the terminal or more conveniently, remotely using a 0 – 10 VDC analog output from a digital controller via the BAS. A fan volume versus DC volts calibration chart is provided. The importance of this feature is that the balancer never has to go into the ceiling to adjust the fan. This relieves the balancer of most of his work per zone on fan powered terminal units and related headaches. This also removes the uncertainty of diffuser flow measurement with hoods. Laboratory tests show the fan cfm to be accurate within +/- 5% of the factory set point. This is a huge benefit to the owner, the controls contractor, the mechanical contractor and the ceiling contractor.

ENERGY SAVINGS

The following graphs show the energy savings of units with ECM's compared to units with Nailor engineered PSC motors. Since PSC motors used by Nailor are built specifically for Nailor fan powered terminal units and are more efficient than those used by most of our competitors.

A comparison using Nailor units with ECM's and a competitor's units with PSC motors would show even greater savings.

The typical range of operation for the size 3 would be 200 to about 900 cfm (94 to 425 l/s). The typical range of operation for the size 5 unit would be 700 to 1700 cfm (330 to 802 l/s).

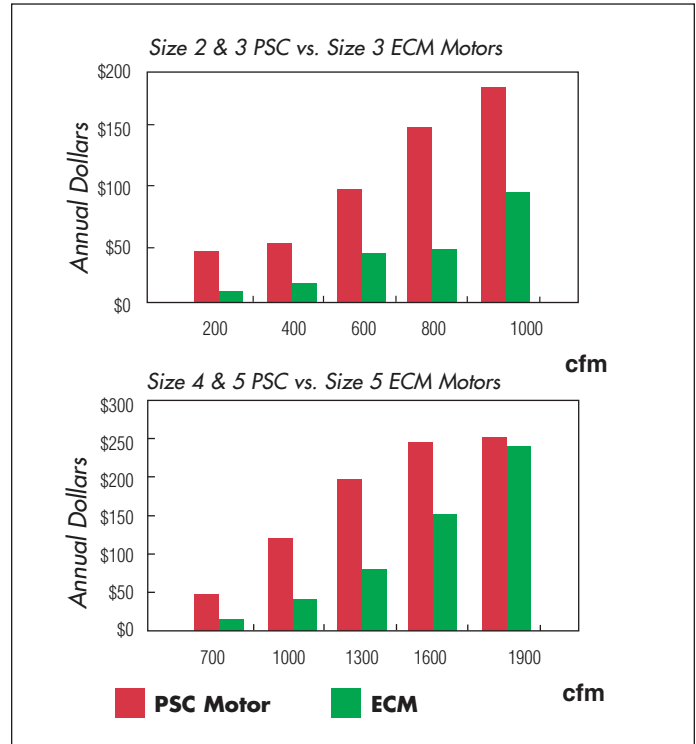

Figure 2. Typical operating cost comparison.

WHAT IS THE PAYBACK PERIOD ON ECM MOTORS?

The payback period varies. It depends on which unit you use, where you set the cfm, how much you run the equipment and what you are paying for electricity. The graphs above are calculated assuming 66 hours per week operations and \$.10 per kWh. If you run the equipment longer in your building or if you pay more for electricity, the payback will change proportionally. Considering the pre-set capability of the motor, there should be an up-front savings on balancing. That should be rebated to the owner and should be considered as part of the payback from the motor. Typically, with the balancing rebate and the operating expenses as shown above, the payback period should be anywhere from 6 to 18 months.

Recommended Primary Valve Airflow Ranges For All Fan Powered Terminal Units

The recommended airflow ranges below are for fan powered terminal units with pressure independent controls and are presented as ranges for total and controller specific minimum and maximum airflow. Airflow ranges are based upon maintaining reasonable sound levels and controller limits using Nailor's Diamond Flow Sensor as the airflow measuring device. For a given unit size, the minimum, auxiliary and the maximum flow setting must be within the range limits to ensure pressure independent operation, accuracy and repeatability.

Minimum airflow limits are based upon .02" w.g. (5 Pa) differential pressure signal from Diamond Flow Sensor on analog/digital controls and .03" (7.5) for pneumatic controllers. This is a realistic low limit for many transducers used in the digital controls industry. Check your controls supplier for minimum limits. Setting airflow minimums lower, may cause hunting and failure to meet minimum ventilation requirements.

The high end of the tabulated Total Airflow Range on pneumatic and analog electronic controls represents the Diamond Flow Sensor's differential pressure reading at 1" w.g. (249 Pa). The high end airflow range for digital controls is represented by the indicated transducer differential pressure.

ASHRAE 130 "Performance Rating of Air Terminals" is the method of test for the certification program. The "standard rating condition" (certification rating point) airflow volumes for each terminal unit size are tabulated below per AHRI Standard 880. These air volumes equate to an approximate inlet velocity of 2000 fpm (10.2 m/s).

When digital or other controls are mounted by Nailor, but supplied by others, these values are guidelines only, based upon experience with the majority of controls currently available. Controls supplied by others for factory mounting are configured and calibrated in the field. Airflow settings on pneumatic and analog controls supplied by Nailor are factory preset when provided.

Imperial Units, Cubic Feet per Minute

Inlet Size	Inlet Type	Total Airflow Range, cfm	Airflow at 2000 fpm Inlet Velocity (nom.), cfm	Range of Minimum and Maximum Settings, cfm								
				Pneumatic 3000 Controller		Analog Electronic Controls		Digital Controls				
				Transducer Differential Pressure (w.g.)								
				Min.	Max.	Min.	Max.	Min.	Max.			
.03	1.0	.02	1.0	.02	1.0	1.25	≥ 1.5					
4	Round	0 – 225	150	30	180	25	180	25	180	200	225	
5		0 – 400	250	55	325	45	325	45	325	360	400	
6		0 – 550	400	80	450	65	450	65	450	500	550	
7		0 – 800	550	115	650	95	650	95	650	725	800	
8		0 – 1100	700	155	900	125	900	125	900	1000	1100	
9		0 – 1400	900	200	1150	165	1150	165	1150	1285	1400	
10		0 – 1840	1100	260	1500	215	1500	215	1500	1675	1840	
12		0 – 2500	1600	355	2050	290	2050	290	2050	2290	2500	
14		0 – 3370	2100	475	2750	390	2750	390	2750	3075	3370	
16		0 – 4510	2800	640	3700	520	3700	520	3700	4120	4510	
12		Flat Oval	0 – 2500	1600	355	2050	290	2050	290	2050	2300	2500
14			0 – 3125	2100	440	2550	360	2550	360	2550	2850	3125
16			0 – 3725	2800	525	3040	430	3040	430	3040	3400	3725
18			0 – 5265	3500	750	4300	610	4300	610	4300	4800	5265
14 x 8		Rect.	0 – 2450	1560	350	2000	290	2000	290	2000	2240	2450
14 x 10			0 – 2950	1900	420	2400	340	2400	340	2400	2700	2950

Metric Units, Liters per Second

Inlet Size	Inlet Type	Total Airflow Range, l/s	Airflow at 10.2 m/s Inlet Velocity (nom.), l/s	Range of Minimum and Maximum Settings, l/s								
				Pneumatic 3000 Controller		Analog Electronic Controls		Digital Controls				
				Transducer Differential Pressure (Pa)								
				Min.	Max.	Min.	Max.	Min.	Max.			
7.5	249	5	249	5	249	311	≥ 374					
4	Round	0 – 106	71	14	85	12	85	12	85	94	106	
5		0 – 189	118	26	153	21	153	21	153	170	189	
6		0 – 260	189	38	212	31	212	31	212	236	260	
7		0 – 378	260	54	307	45	307	45	307	342	378	
8		0 – 519	330	73	425	59	425	59	425	472	519	
9		0 – 661	425	94	543	78	543	78	543	606	661	
10		0 – 868	519	123	708	101	708	101	708	790	868	
12		0 – 1180	755	168	967	137	967	137	967	1081	1180	
14		0 – 1590	991	224	1298	184	1298	184	1298	1451	1590	
16		0 – 2128	1321	302	1746	245	1746	245	1746	1944	2128	
12		Flat Oval	0 – 1180	755	168	967	137	967	137	967	1085	1180
14			0 – 1475	991	208	1203	170	1203	170	1203	1345	1475
16			0 – 1758	1321	248	1435	203	1435	203	1435	1604	1758
18			0 – 2485	1652	354	2029	288	2029	288	2029	2265	2485
14 x 8		Rect.	0 – 1156	736	165	944	137	944	137	944	1057	1156
14 x 10			0 – 1392	897	198	1133	160	1133	160	1133	1274	1392

SERIES FLOW • CONSTANT OR VARIABLE VOLUME

33SZ SERIES

- CHILLED WATER (SENSIBLE) COOLING COIL
- DOAS APPLICATIONS

Models:

- 33SZ** No Heat
- 33SZE** Electric Heat
- 33SZW** Hot Water Heat



Model 33SZ

The **33SZ Series** Fan Powered Chilled Water Terminal Units (FPCWTU) enhance Nailor's already efficient and flexible Series Fan Terminal Unit product line. The 33SZ incorporates a cooling induction coil to use in conjunction with a DOAS (Dedicated Outdoor Air System). Useful in a variety of commercial and educational applications, like classrooms, office space, laboratories and auditoriums, the 33SZ provides a flexible, industry familiar unit that excels at zone sensible cooling while the dedicated outdoor air inlet delivers ASHRAE 62.1 ventilation requirements.

STANDARD FEATURES:

- Standard height and low-profile designs available.
- Sensible cooling coil on the induced air inlet handles zone sensible load. Opposite side to controls location. Coil is constructed of aluminum ripple fins (10 FPI) and 1/2" (13) copper tubes. Hand of coil is determined looking in direction of airflow.
- 18 ga. (1.31) galvanized steel channel frame with 20 ga. (1.0) casing components. Sizes 40 and 50 only.
- 20 ga. (1.0) galvanized steel casing construction. Size 30.
- 16 ga. (1.61) galvanized steel inclined opposed blade damper. 45° rotation. CW to close. Sizes 30, 40 and 50.
- Galvanized steel drip pan integral to sensible coil.
- Discharge opening designed for flanged duct connection.
- Controls mounted as standard on RH side as shown. Terminals ordered with LH controls (optional) are inverted and discharge duct hanging elevation will therefore change.
- Single point electrical connection.
- Access panels top and bottom.
- Multi-point averaging Diamond Flow sensor.

- Low voltage NEMA 1 type enclosure for factory mounted digital controls.
- ECM/EPIC Fan Technology®.
- Dual density fiberglass insulation, exposed edges coated to prevent air erosion. Meets requirements of NFPA 90A and UL 181. 1/2" (13) thick on unit size 30. 3/4" (19) thick on unit sizes 40 and 50.

OPTIONS:

CW Coil:

- 2-Row, 4-Row and 6-Row
- Right or Left Hand coil connections.
- Condensate Sensor.

Liner:

- Fiber-free liner.
- Perforated metal liner.
- Solid metal liner.
- Steri-liner.
- Steri-liner w/perforated liner.

Silencer Section:

- Designed to mate with VAV section for optimum performance and quiet operation.
- Optimized internal baffle geometry reduces self-generated noise, maximizes acoustic attenuation.

- 22 ga. (0.86) coated steel perforated baffles with 13% free area encapsulate fiberglass acoustic media. Mylar lining with acoustical spacer isolates material from airstream.

Filter:

- 1" (25) Throwaway.
- 2" (51) Pleated MERV 8.
- 2" (51) Pleated MERV 13.
- Ducted Return Filter Rack.

Electrical:

- Left Hand Controls enclosure
- Toggle disconnect switch.
- FN2 – 90° Line Voltage enclosure.
- FN3 – Remote Line Voltage enclosure.
- Motor fusing.

Others:

- Hanger brackets.
- 1/4-turn fasteners (access panel).



Dimensions

Model Series 33SZ • FPCWTU (DOAS) • Series Flow • Unit Size 30 (Low Profile)

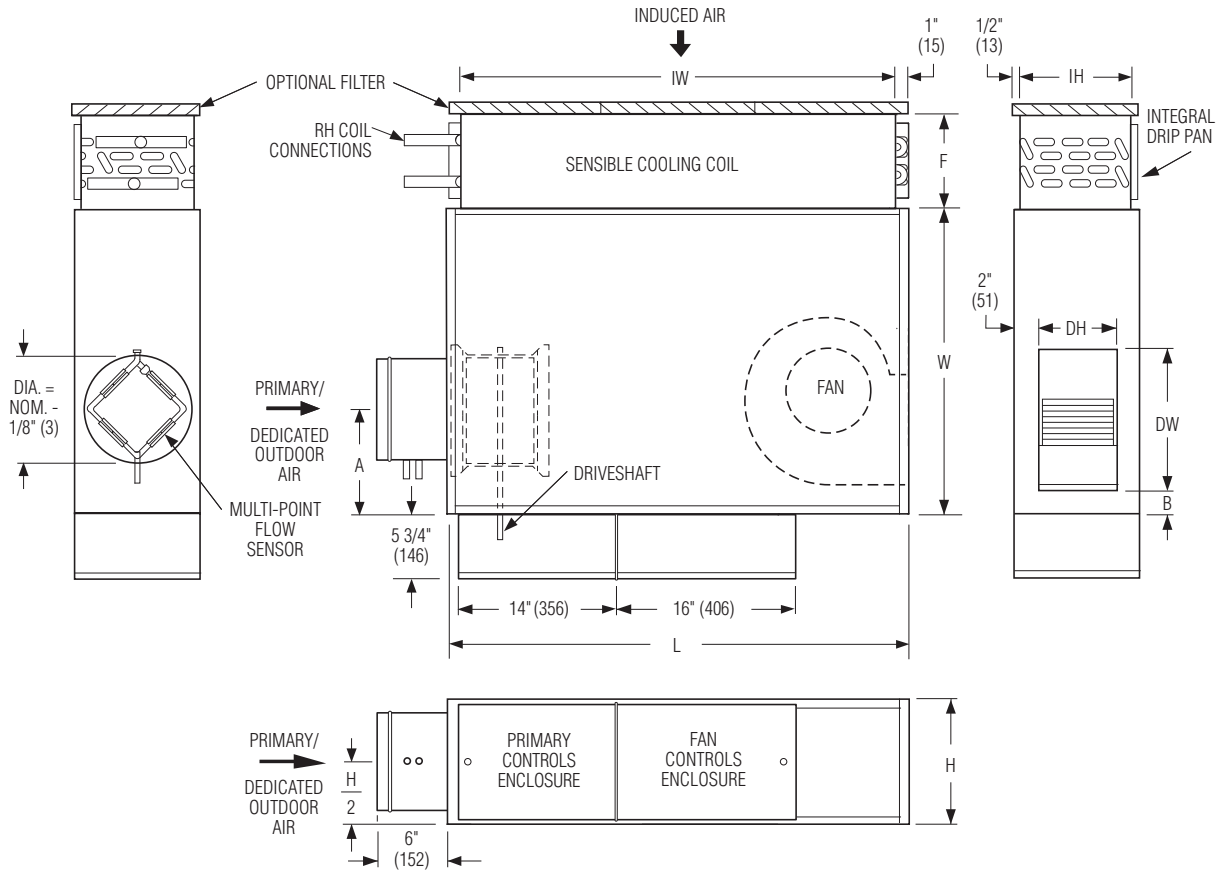

Dimensional Data

Unit Size	Inlet Size	W	H	L	A	B	Cooling Coil IW x IH	F	Outlet Discharge DW x DH	Filter Size
30	4, 5, 6, 8 (102, 127, 152, 203)	26 1/2 (673)	11 (279)	40 1/4 (1022)	8 (203)	2 (51)	36 x 8 3/4 (914 x 222)	2 Row: 5 1/8 (130) 4 Row: 7 5/16 (186) 6 Row: 9 1/2 (241)	12 3/8 x 6 7/8 (314 x 175)	38 x 10 (965 x 254)

CW Coil O.D. Sweat Connections

Unit Size	No. of Row
30	2, 4, & 6
	7/8" (22)

Dimensions

Model Series 33SZ • FPCWTU (DOAS) • Series Flow • Unit Sizes 40 – 50

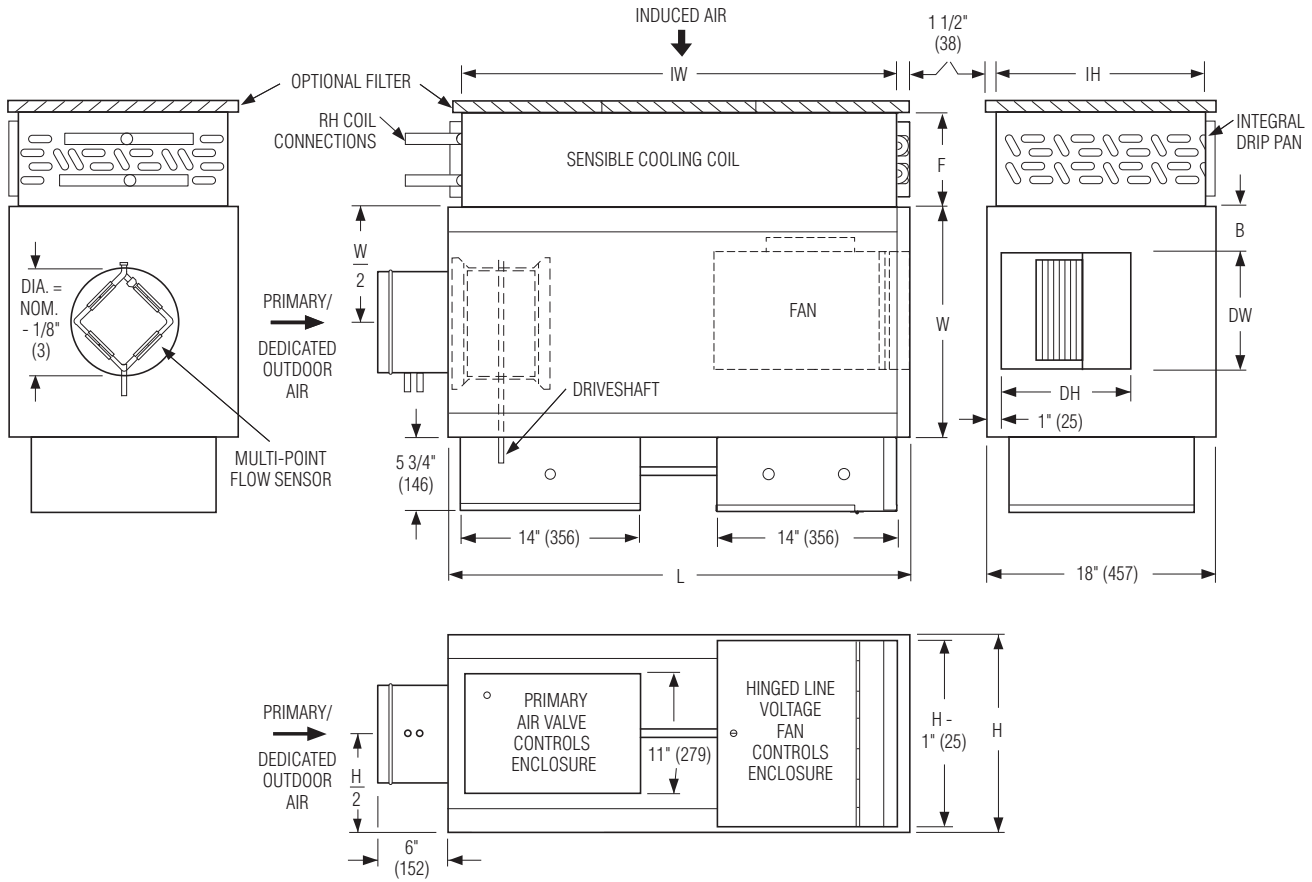

Dimensional Data

Unit Size	Inlet Size	W	H	L	B	Cooling Coil IW x IH	F	Outlet Discharge DW x DH	Filter Size
40	4, 5, 6, 8, 10 (102, 127, 152, 203, 254)	18 (457)	18 (457)	36 (914)	3 1/2 (89)	31 x 15 (787 x 381)	2 Row: 5 1/8 (130) 4 Row: 7 5/16 (186)	9 1/8 x 10 1/4 (232 x 260)	33 x 16 (838 x 406)
50	5, 6, 8, 10, 12 (127, 152, 203, 254, 305)	26 (660)	18 (457)	41 (1041)	5 (127)	36 x 15 (914 x 381)	6 Row: 9 1/2 (241)	13 1/8 x 11 1/4 (333 x 286)	38 x 16 (965 x 406)

CW Coil O.D. Sweat Connections

Unit Size	No. of Row
40	2, 4, & 6
50	7/8" (22)

FAN POWERED TERMINAL UNITS



Dimensions

Model Series 33SZ • FPCWTU (DOAS) • Series Flow

Hot Water Coil Section

Model 33SZW

Available in one or two row. Coil section installed on unit discharge. Right hand coil connection looking in direction of airflow standard (shown). Left hand is optional.

Standard Features:

- Coil section installed on unit discharge.
- 1/2" (13) copper tubes.
- Aluminum ripple fins @10 FPI.
- Sweat Connections:
Size 30: 1 Row 1/2" (13) and 2 Row 5/8" (16); O.D. male solder.
Size 40: 1 Row 1/2" (13); O.D. male solder.
All others: 7/8" (22); O.D. male solder.
- Flanged outlet duct connection.

Coil Rows:

- 1-Row
- 2-Row

Coil Hand Connections:

(Looking in direction of airflow).

- Right Hand (illustrated). Standard.
- Left Hand. Optional.

Heating coil, sensible cooling coil and controls enclosure orientation must all be specified separately.

Unit Size 30 (Low Profile)

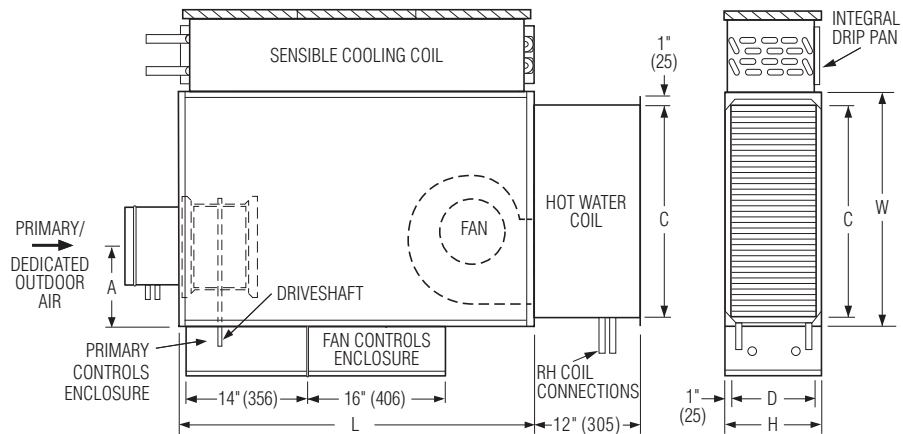

Unit Sizes 40 and 50

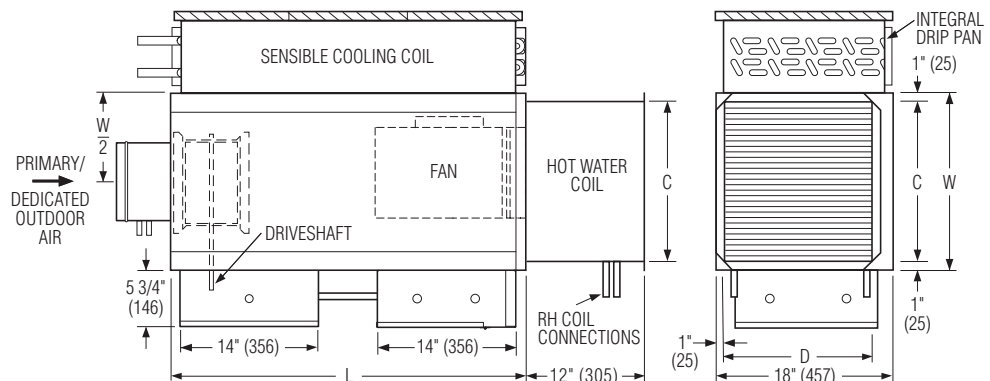

Unit Size	W	H	L	Outlet Duct Size C x D
30	26 1/2 (673)	11 (279)	40 1/4 (1022)	24 x 8 3/4 (610 x 222)
40	18 (457)	-	36 (914)	16 x 15 (406 x 381)
50	26 (660)	-	41 (1041)	24 x 15 (610 x 381)

Dimensions

Model Series 33SZ • FPCWTU (DOAS) • Series Flow

Electric Coil Section

Unit Size 30 (Low Profile)

Model 33SZE

Standard Features:

- Unique hinged heater design permits easy access, removal and replacement of heater element without disturbing ductwork.
- Coil installed on unit discharge.
- Insulated coil element wrapper.
- Automatic reset high limit cut-outs (one per element).
- Single point electrical connection for entire terminal unit.
- Magnetic contactors per stage.
- Class A 80/20 Ni/Cr wire.
- Electronic Fan Interlock Relay.
- Flanged outlet duct connection.
- Terminal unit with coil is ETL listed as on assembly.
- Controls mounted as standard on RH side as shown. Terminals ordered with L.H. controls (optional) are inverted and discharge duct hanging elevation will change.

Standard Supply Voltage (60 Hz):

- Single phase: 120, 208, 240 & 277V.
- Three phase: 208, 480 (4 wire wye) and 600V (dual point connection).

Options:

- SCR control.
- SCR control with discharge temperature control.
- Toggle disconnect switch (includes fan).
- Door interlock disconnect switch.
- Quiet contactors.
- Main line fusing.
- Dust tight construction.
- Manual Reset secondary thermal cut out.
- Positive Pressure airflow switch.

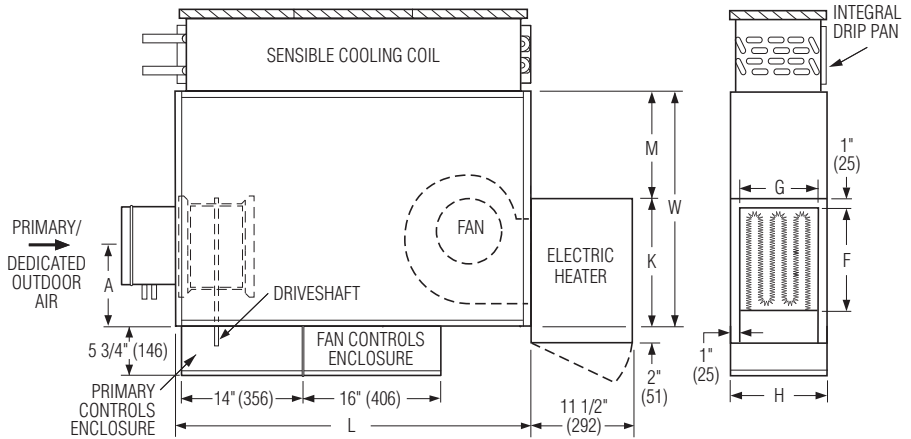

Unit Sizes 40 and 50

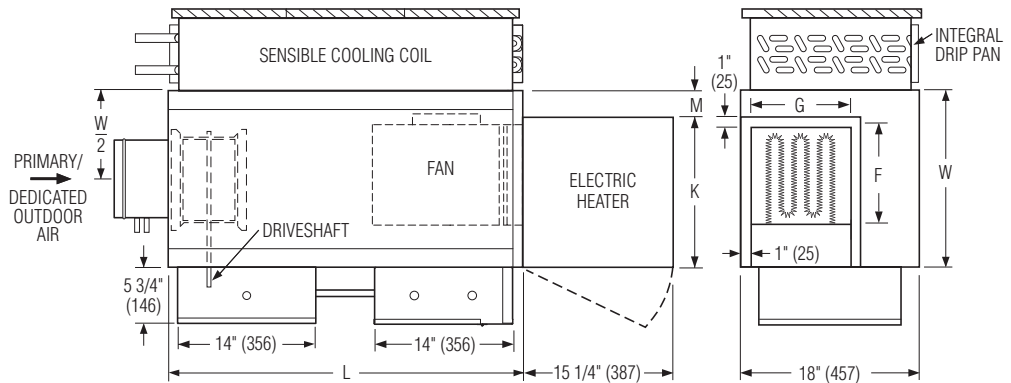

Unit Size	W	H	L	K	M	Outlet Duct Size F x G
30	26 1/2 (673)	11 (279)	40 1/4 (1022)	15 3/8 (391)	11 1/8 (283)	12 3/8 x 9 (314 x 229)
40	18 (457)	—	36 (914)	15 1/2 (394)	2 1/2 (64)	10 1/4 x 10 1/2 (260 x 267)
50	26 (660)	—	41 (1041)	22 (559)	4 (102)	14 1/4 x 11 3/4 (362 x 298)

Dimensions

Model Series 33SZ • FPCWTU (DOAS) • Series Flow • Unit Size 30 (Low Profile)
 With 90° Line Voltage Enclosure (FN2 Option)

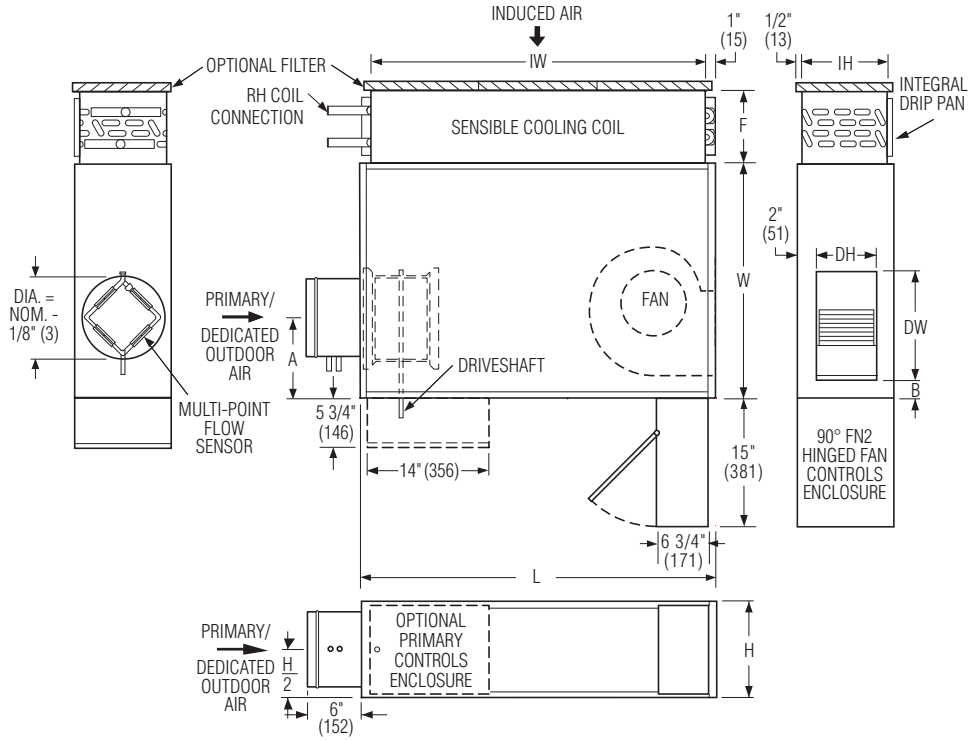

Dimensional Data

Unit Size	Inlet Size	W	H	L	A	B	Cooling Coil IW x IH	F	Outlet Discharge DW x DH	Filter Size
30	4, 5, 6, 8 (102, 127, 152, 203)	26 1/2 (673)	11 (279)	40 1/4 (1022)	8 (203)	2 (51)	36 x 8 3/4 (914 x 222)	2 Row: 5 1/8 (130) 4 Row: 7 5/16 (186) 6 Row: 9 1/2 (241)	12 3/8 x 6 7/8 (314 x 175)	38 x 10 (965 x 254)

CW Coil O.D.
Sweat Connections

Unit Size	No. of Row
30	2, 4, & 6
	7/8" (22)

Dimensions

Model Series 33SZ • FPCWTU (DOAS) • Series Flow • Unit Sizes 40 – 50
 With 90° Line Voltage Enclosure (FN2 Option)

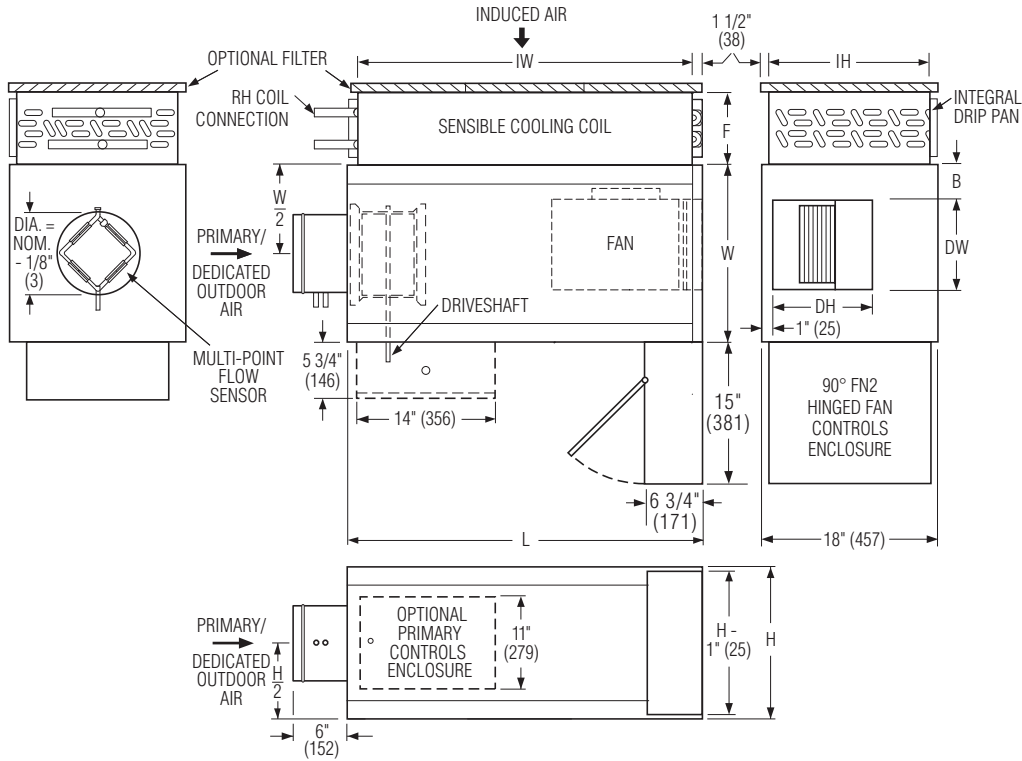

Dimensional Data

Unit Size	Inlet Size	W	H	L	B	Cooling Coil IW x IH	F	Outlet Discharge DW x DH	Filter Size
40	4, 5, 6, 8, 10 (102, 127, 152, 203, 254)	18 (457)	18 (457)	36 (914)	3 1/2 (89)	31 x 15 (787 x 381)	2 Row: 5 1/8 (130)	9 1/8 x 10 1/4 (232 x 260)	33 x 16 (838 x 406)
							4 Row: 7 5/16 (186)		
50	5, 6, 8, 10, 12 (127, 152, 203, 254, 305)	26 (660)	18 (457)	41 (1041)	5 (127)	36 x 15 (914 x 381)	6 Row: 9 1/2 (241)	13 1/8 x 11 1/4 (333 x 286)	38 x 16 (965 x 406)

CW Coil O.D.
Sweat Connections

Unit Size	No. of Row 2, 4, & 6
40	
50	7/8" (22)

FAN POWERED TERMINAL UNITS



Dimensions

Model Series 33SZ • FPCWTU (DOAS) • Series Flow
With 90° Line Voltage Enclosure (FN2 Option)

Hot Water Coil Section

Model 33SZW

Available in one or two row. Coil section installed on unit discharge. Right hand coil connection looking in direction of airflow standard (shown). Left hand is optional.

Standard Features:

- Coil section installed on unit discharge.
- 1/2" (13) copper tubes.
- Aluminum ripple fins @10 FPI.
- Sweat Connections:
 Size 30: 1 Row 1/2" (13), 2 Row: 5/8" (16); O.D. male solder.
 Size 40: 1 Row 1/2" (13); O.D. male solder.
 All others: 7/8" (22); O.D. male solder.

- Flanged outlet duct connection.

Coil Rows:

- 1-Row
- 2-Row

Coil Hand Connections:

(Looking in direction of airflow).

- Right Hand (illustrated). Standard.
- Left Hand. Optional.

Heating coil, sensible cooling coil and controls enclosure orientation must all be specified separately.

Unit Size 30 (Low Profile)

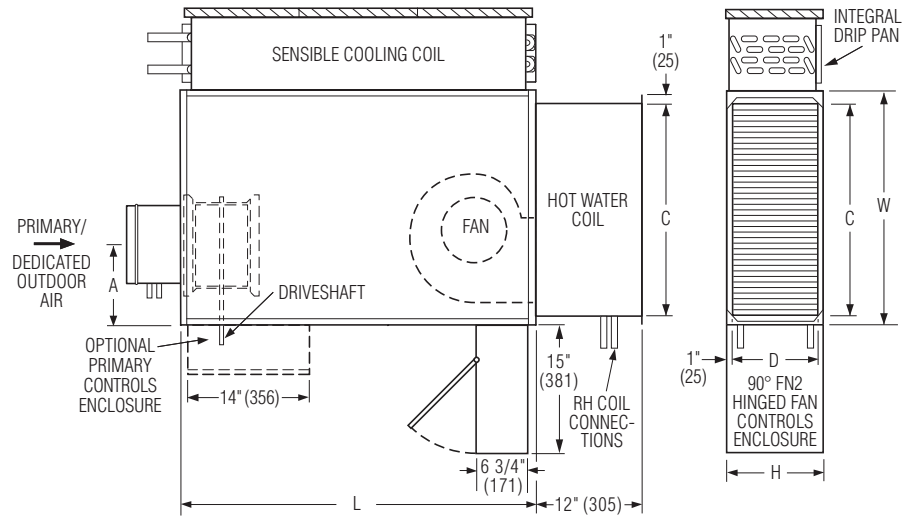

Unit Sizes 40 and 50

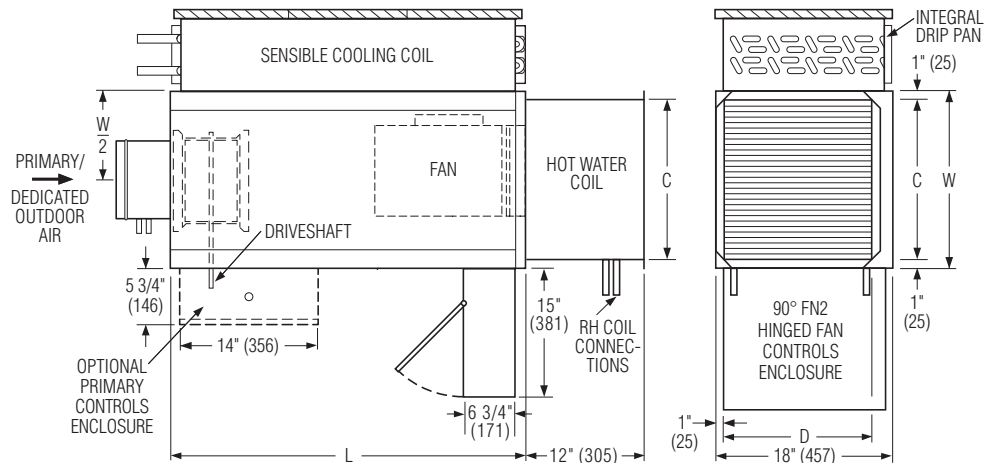

Unit Size	W	H	L	Outlet Duct Size C x D
30	26 1/2 (673)	11 (279)	40 1/4 (1022)	24 x 8 3/4 (610 x 222)
40	18 (457)	—	36 (914)	16 x 15 (406 x 381)
50	26 (660)	—	41 (1041)	24 x 15 (610 x 381)

Dimensions

Model Series 33SZ • FPCWTU (DOAS) • Series Flow
With 90° Line Voltage Enclosure (FN2 Option)

Electric Coil Section

Model 33SZE

Standard Features:

- Unique hinged heater design permits easy access, removal and replacement of heater element without disturbing ductwork.
- Coil installed on unit discharge.
- Insulated coil element wrapper.
- Automatic reset high limit cut-outs (one per element).
- Single point electrical connection for entire terminal unit.
- Magnetic contactors per stage.
- Class A 80/20 Ni/Cr wire.
- Electronic Fan Interlock Relay.
- Flanged outlet duct connection.
- Terminal unit with coil is ETL listed as on assembly.
- Controls mounted as standard on RH side as shown. Terminals ordered with L.H. controls (optional) are inverted and discharge duct hanging elevation will change.

Standard Supply Voltage (60 Hz):

- Single phase: 120, 208, 240 & 277V.
- Three phase: 208, 480 (4 wire wye) and 600V (dual point connection).

Options:

- SCR control.
- SCR control with discharge temperature control.
- Toggle disconnect switch (includes fan).
- Door interlock disconnect switch.
- Quiet contactors.
- Main line fusing.
- Dust tight construction.
- Manual Reset secondary thermal cut out.
- Positive Pressure airflow switch.

Unit Size 30 (Low Profile)

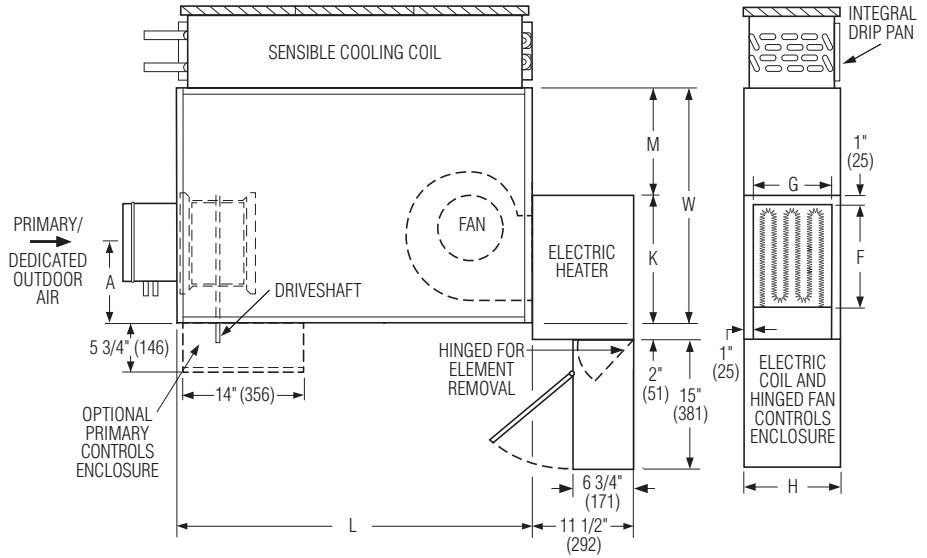

Unit Sizes 40 and 50

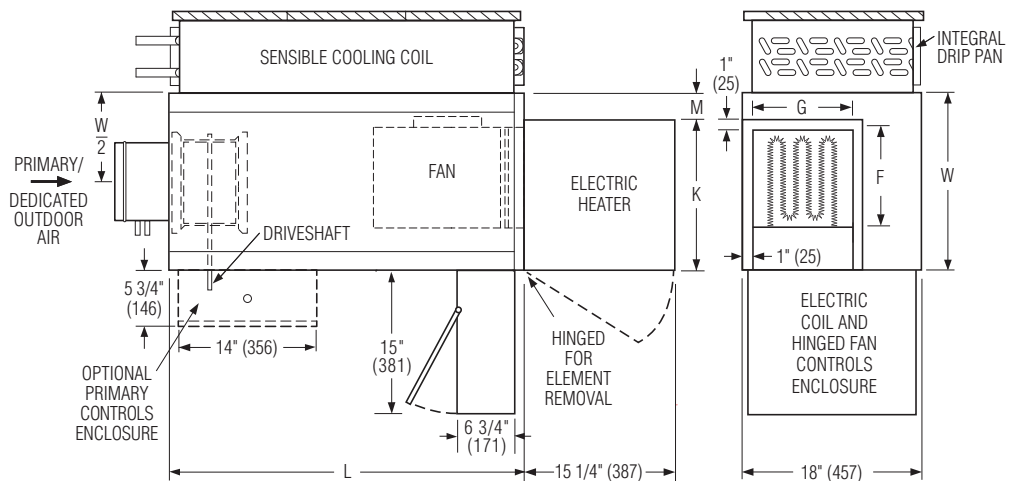

Unit Size	W	H	L	K	M	Outlet Duct Size F x G
30	26 1/2 (673)	11 (279)	40 1/4 (1022)	15 3/8 (391)	11 1/8 (283)	12 3/8 x 9 (314 x 229)
40	18 (457)	—	36 (914)	15 1/2 (394)	2 1/2 (64)	10 1/4 x 10 1/2 (260 x 267)
50	26 (660)	—	41 (1041)	22 (559)	4 (102)	14 1/4 x 11 3/4 (362 x 298)



FAN POWERED TERMINAL UNITS

Dimensions

Model Series 33SZ • Accessories

Universal Ducted Return Filter Rack

Code DRFR

DESCRIPTION:

- The DRFR (Ducted Return Filter Rack) is an optional accessory for the Fan Powered Chilled Water Terminal Model Series 33SZ.
- The accessory is required for ducted inlet applications where a filter is also required and ease of accessibility is required.
- The Ducted Filter Connection features a filter rack, which accommodates a 1" (25) standard or 2" (51) optional filter.
- Factory mounted on the induced air inlet of the draw through water coil section.
- A piano-hinged door flap with latch on the side and bottom of the unit accessory allows for easy removal and replacement of the filter.
- The accessory is provided with a nominally sized duct connection collar.

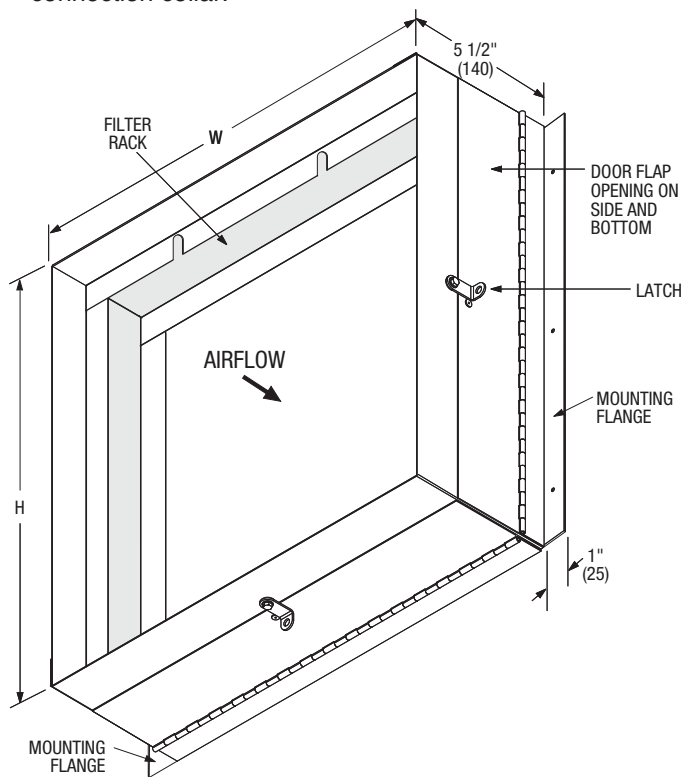

Dimensional Data

Unit Size	Inlet Size W x H	Filter Size
30	36 x 8 3/4 (914 x 222)	38 x 10 (965 x 254)
40	31 x 15 (787 x 381)	33 x 16 (838 x 406)
50	36 x 15 (914 x 381)	38 x 16 (965 x 406)

"Stealth™" Induced Air Dissipative Silencer

Code DSI



DESCRIPTION:

- The DSI (Dissipative Silencer) is an optional induced air inlet accessory for the Fan Powered Chilled Water Terminal Model Series 33SZ and is shipped loose for field attachment.
- The "Stealth™" dissipative silencer provides maximum acoustic attenuation by reducing radiated sound power levels.
- Silencer casing is constructed with 22 ga. (0.86) coated steel lined with same insulation selected on terminal unit.
- Perforated baffles are 13% free area, 22 ga. (0.86) galvanized steel construction. Baffles are lined with exposed fiberglass acoustic media. Optional Mylar/Spacer Liner.

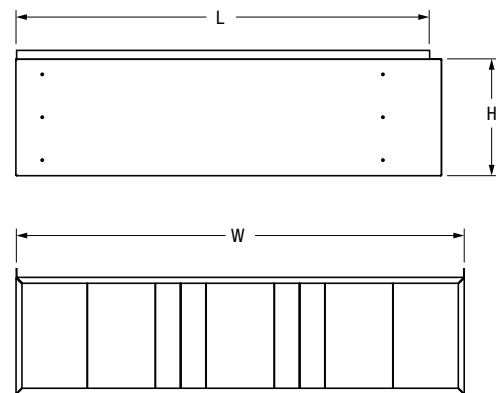

Dimensional Data

Unit Size	L	W	H
30	36 (914)	38 (965)	9 7/8 (251)
40	36 (914)	33 (838)	16 1/2 (419)
50	36 (914)	38 (965)	16 1/2 (419)

Radiated Sound Deductions

Unit Size	Sound Power Octave Band						Average NC Reduction
	2	3	4	5	6	7	
30	4	5	8	11	10	10	-5
40	5	5	8	11	14	12	
50	5	5	8	9	12	14	

Performance Data

ECM Motor Fan Curves – Airflow vs. Downstream Static Pressure

33SZ Series • FPCWTU (DOAS)

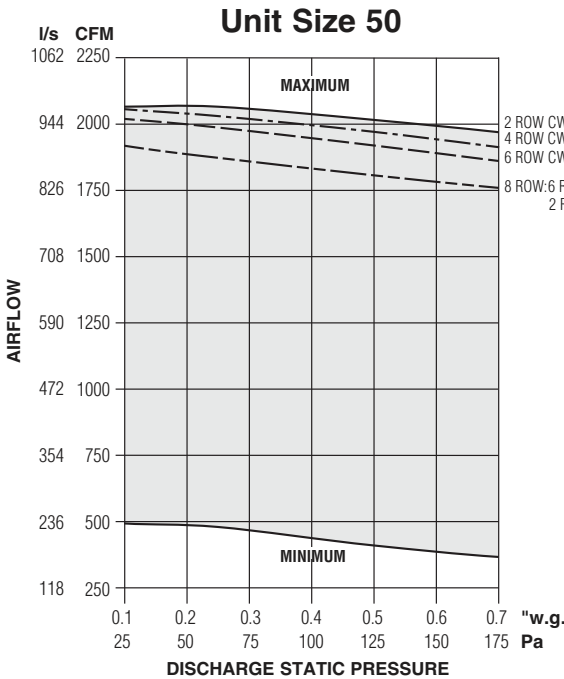
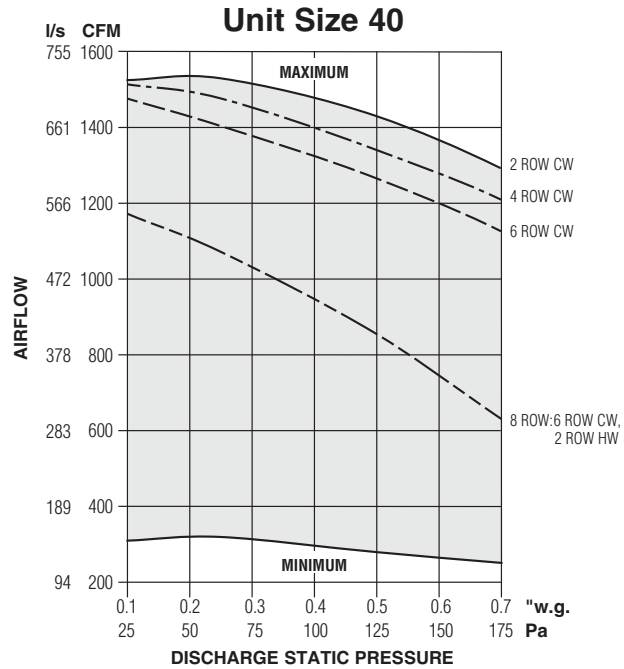
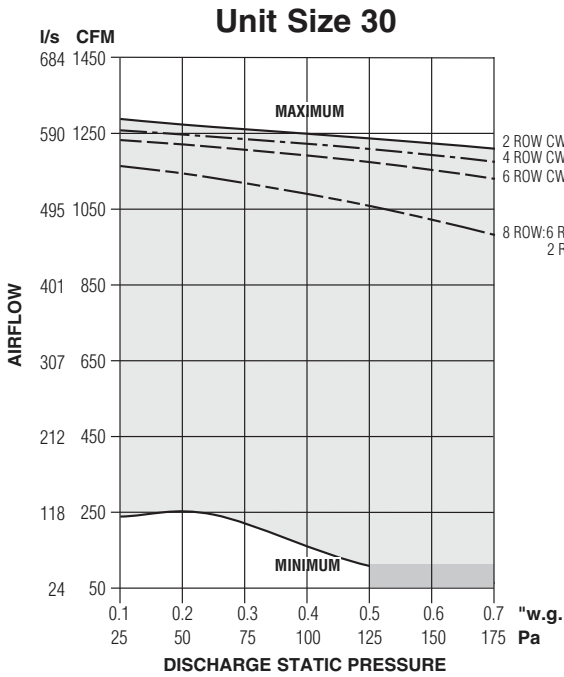

Electrical Data

Unit Size	EPIC ECM Motor FLA				
	Motor HP	120V	208V	240V	277V
30	*	7.5	5.0	5.0	4.9
40	*	6.5	4.3	4.2	4.2
50	*	9.5	6.4	6.2	6.0

* The ECM is a variable horsepower motor. Refer to Selectworks schedule for actual power consumption. FLA = Full load amperage. All motors are single phase/60 Hz.

NOTES:

• The ECM is pressure independent and constant volume in operation at factory or field set point within the shaded area. When the setpoint is on or below the respective maximum curve, airflow does not vary with changing static pressure conditions. The motor compensates for any changes in external static pressure or induced air conditions such as filter loading.

- Fan curves shown are applicable to 120, 208, 240 and 277 volt, single phase ECM's. ECM's, although DC in operation, include a built-in AC/DC converter.
- Minimum operation within the dark shaded area is not predictable.

Performance Data • NC Level Application Guide
 Model Series 33SZ • Series Flow • FPCWTU (DOAS)

Unit Size	Inlet Size	Primary Airflow		Fan Airflow		Min. inlet ΔPs		Fan and 100% Primary Air-Sound Power Octave Bands @ Inlet pressure (ΔPs) shown									
		cfm	l/s	cfm	l/s	"w.g.	Pa	DISCHARGE					RADIATED				
								Fan Only	Minimum ΔPs	0.5" w.g. (125Pa)	1.0" w.g. (250Pa)	1.5" w.g. (375Pa)	Fan Only	Minimum ΔPs	0.5" w.g. (125Pa)	1.0" w.g. (250Pa)	1.5" w.g. (375Pa)
30	4	225	106	1250	590	0.42	104	38	37	37	38	38	43	40	40	41	41
		150	71	1000	472	0.15	37	34	31	31	31	33	38	37	37	37	37
		150	71	800	378	0.20	50	26	28	26	28	28	35	34	34	34	34
		90	42	500	236	0.06	15	-	-	-	-	-	26	26	26	26	28
		90	42	250	118	0.10	25	-	-	-	-	-	22	23	23	23	24
	6	550	260	1250	590	0.12	30	38	37	37	37	38	43	40	40	41	41
		400	189	1000	472	0.06	15	34	31	30	30	31	38	37	37	37	37
		400	189	800	378	0.10	25	26	26	25	25	26	35	33	34	34	35
		235	111	500	236	0.03	6	-	-	-	-	-	26	26	28	30	32
		190	90	250	118	0.03	7	-	-	-	-	-	22	23	23	25	28
	8	1100	519	1250	590	0.09	22	38	37	37	37	37	43	41	41	41	43
		700	330	1000	472	0.01	2	34	31	30	30	30	38	37	37	37	38
		415	196	800	378	0.01	2	26	26	25	25	25	35	33	34	34	35
		250	118	500	236	0.01	2	-	-	-	-	-	26	26	26	28	29
		190	90	250	118	0.01	2	-	-	-	-	-	23	22	23	24	26
40	4	225	106	1500	708	0.56	139	31	35	-	36	36	44	43	-	43	44
		150	71	1200	566	0.21	52	27	26	28	28	28	39	40	41	41	41
		150	71	900	425	0.26	65	-	21	23	24	24	33	34	35	35	36
		90	42	600	283	0.08	20	-	-	-	-	-	31	33	34	33	32
		90	42	300	142	0.10	25	-	-	-	-	-	26	30	30	30	31
	6	550	260	1500	708	0.31	77	31	31	33	34	35	44	41	41	43	44
		400	189	1200	566	0.07	17	27	26	27	27	26	39	38	38	39	39
		400	189	900	425	0.09	22	-	20	21	21	23	33	32	33	34	35
		235	111	600	283	0.03	7	-	-	-	-	20	31	29	29	29	29
		145	68	300	142	0.02	5	-	-	-	-	-	26	24	25	25	26
	8	1100	519	1500	708	0.09	22	31	33	33	33	34	43	43	44	44	44
		700	330	1200	566	0.02	5	27	27	28	29	30	38	38	38	39	40
		415	196	900	425	0.01	2	20	21	21	23	24	34	33	34	34	35
		290	137	600	283	0.01	2	-	-	-	-	-	29	28	29	30	31
		175	83	300	142	0.01	2	-	-	-	-	-	25	25	25	25	26
10	1400	661	1500	708	0.02	5	32	31	33	34	34	43	41	43	44	45	
	660	311	1200	566	0.01	2	30	29	30	30	30	38	37	38	38	39	
	445	210	900	425	0.01	2	20	22	21	22	23	33	32	33	34	34	
	335	158	600	283	0.01	2	-	-	-	20	21	29	29	29	29	29	
	260	123	300	142	0.01	2	-	-	-	-	-	24	24	24	25	28	
50	4	225	106	2000	944	0.51	127	26	31	-	31	33	40	41	-	41	43
		150	71	1600	755	0.18	45	21	23	24	25	28	36	36	36	37	38
		150	71	1200	566	0.24	60	-	-	-	-	20	31	32	32	32	33
		90	42	800	378	0.08	20	-	-	-	-	-	25	24	24	25	26
		90	42	500	236	0.10	25	-	-	-	-	-	23	23	23	24	25
	6	550	260	2000	944	0.12	30	26	29	30	30	31	40	41	43	43	43
		400	189	1600	755	0.04	10	21	21	23	25	26	36	36	36	37	38
		400	189	1200	566	0.09	22	-	-	-	-	23	31	33	33	34	35
		235	111	800	378	0.02	5	-	-	-	-	-	25	24	25	28	30
		235	111	500	236	0.04	10	-	-	-	-	-	22	23	24	26	29
	8	1100	519	2000	944	0.12	30	27	28	29	29	30	40	41	43	43	43
		700	330	1600	755	0.02	5	21	21	24	25	28	36	36	37	38	40
		700	330	1200	566	0.06	15	-	-	-	20	23	32	33	33	35	36
		415	196	800	378	0.01	2	-	-	-	-	-	25	24	26	29	32
		250	118	500	236	0.01	2	-	-	-	-	-	23	23	24	26	29
10	1840	868	2000	944	0.25	62	28	29	29	30	31	40	43	44	45	46	
	1100	519	1600	755	0.08	20	21	20	23	24	26	36	36	37	38	39	
	660	311	1200	566	0.01	2	-	-	-	-	23	31	31	32	33	35	
	410	193	800	378	0.01	2	-	-	-	-	-	25	24	25	28	30	
	375	177	500	236	0.01	2	-	-	-	-	-	23	22	24	26	29	
12	2000	944	2000	944	0.09	22	28	28	29	31	33	40	41	44	45	46	
	1600	755	1600	755	0.06	15	21	20	24	26	29	36	36	38	40	43	
	595	281	1200	566	0.01	2	-	-	-	-	-	31	31	32	33	34	
	445	210	800	378	0.01	2	-	-	-	-	-	25	24	25	28	30	
	395	186	500	236	0.01	2	-	-	-	-	-	22	22	24	26	30	

For full performance table notes, see page C28.

Performance Data • Discharge Sound Power Levels

Model Series 33SZ • Series Flow • FPCWTU (DOAS)

Unit Size	Inlet Size	Primary Airflow		Fan Airflow		Min. inlet ΔPs "w.g. Pa	Fan and 100% Primary Air-Sound Power Octave Bands @ Inlet pressure (ΔPs) shown																																		
							Fan Only					Minimum ΔPs					0.5" w.g. Inlet Static					1.0" w.g. Inlet Static					1.5" w.g. Inlet Static														
							2	3	4	5	6	7	2	3	4	5	6	7	2	3	4	5	6	7	2	3	4	5	6	7	2	3	4	5	6	7					
30	4	225	106	1250	590	0.42	104	79	78	71	72	71	69	80	77	72	72	71	69	79	77	71	72	71	69	78	78	71	72	71	69	78	78	71	72	71	69				
		150	71	1000	472	0.15	37	77	74	67	69	67	65	76	72	66	67	66	64	75	72	66	67	65	63	76	72	66	67	66	64	76	73	67	68	66	64				
		150	71	800	378	0.20	50	74	68	63	64	62	60	74	69	63	63	62	60	74	68	63	64	62	60	73	69	63	64	62	60	73	69	63	64	62	60				
		90	42	500	236	0.06	15	64	57	55	55	52	48	65	58	55	55	52	49	64	58	55	55	51	48	64	57	55	55	51	47	63	57	55	55	51	47				
		90	42	250	118	0.10	25	58	51	51	49	46	39	59	51	52	50	46	38	59	51	50	48	44	36	58	51	50	48	44	36	57	51	50	47	43	36				
	6	550	260	1250	590	0.12	30	79	78	71	72	71	69	80	77	72	72	71	69	79	77	71	72	71	69	79	77	71	72	71	69	79	78	71	72	71	69				
		400	189	1000	472	0.06	15	77	74	67	69	67	65	76	72	66	67	66	64	75	71	66	67	65	63	75	71	66	67	65	63	75	72	66	67	66	64				
		400	189	800	378	0.10	25	74	68	63	64	62	60	73	68	62	63	61	59	73	67	62	63	61	59	73	67	62	63	61	59	72	68	62	63	61	59				
		235	111	500	236	0.03	6	64	57	55	55	52	48	65	58	55	55	52	48	64	58	55	55	51	47	65	58	55	55	51	47	65	58	55	55	51	47				
		190	90	250	118	0.03	7	58	51	51	49	46	39	58	51	52	50	46	38	60	52	50	48	45	37	60	54	51	49	45	38	61	55	51	49	46	39				
	8	1100	519	1250	590	0.09	22	79	78	71	72	71	69	80	77	72	72	71	69	79	77	71	72	71	69	79	77	71	72	71	69	79	77	71	72	71	69				
		700	330	1000	472	0.01	2	77	74	67	69	67	65	76	72	66	67	66	64	75	71	66	67	65	63	75	71	66	67	65	63	75	71	66	67	65	63				
415		196	800	378	0.01	2	74	68	63	64	62	60	73	68	62	63	61	59	73	67	62	63	61	59	73	67	62	63	61	59	72	67	62	63	61	59					
250		118	500	236	0.01	2	65	57	55	55	52	48	66	57	55	55	52	48	66	57	55	55	51	47	65	57	55	55	51	47	65	57	55	55	51	47					
190		90	250	118	0.01	2	58	51	51	49	46	39	58	50	51	49	45	37	59	51	50	48	44	36	59	52	50	49	45	37	59	53	51	49	45	38					
40	4	225	106	1500	708	0.56	139	75	72	71	74	70	68	75	73	72	73	70	69	-	-	-	-	-	76	74	73	75	71	70	76	74	73	74	71	70					
		150	71	1200	566	0.21	52	71	67	68	68	64	63	68	66	67	67	64	63	69	67	68	68	65	64	69	67	68	68	65	64	69	67	67	68	64	63				
		150	71	900	425	0.26	65	63	56	64	61	57	55	65	59	64	62	58	56	66	62	62	62	58	56	67	62	64	63	59	57	67	61	66	64	60	58				
		90	42	600	283	0.08	20	60	56	58	58	52	46	61	57	59	58	53	47	61	56	56	55	50	44	62	57	58	56	52	46	63	57	59	58	53	48				
		90	42	300	142	0.10	25	60	52	52	49	43	33	59	54	53	51	45	35	59	55	53	51	45	35	59	54	53	50	44	35	58	53	52	50	44	34				
	6	550	260	1500	708	0.31	77	75	72	71	74	70	68	74	71	69	71	67	67	67	75	72	71	73	69	68	75	73	71	73	69	69	76	74	72	73	70	69			
		400	189	1200	566	0.07	17	71	67	68	68	64	63	67	65	66	65	62	62	63	68	65	67	67	63	63	68	66	67	67	63	63	68	67	67	63	62				
		400	189	900	425	0.09	22	63	56	64	61	57	55	63	58	64	61	57	56	66	63	63	62	58	57	66	63	65	63	58	57	69	63	66	63	59	58				
		235	111	600	283	0.03	7	60	56	58	58	52	46	60	56	59	57	52	47	61	56	56	54	50	44	62	57	57	56	51	46	64	59	59	57	53	48				
		145	68	300	142	0.02	5	60	52	52	49	43	33	58	52	52	49	43	32	57	52	51	48	42	32	57	52	51	48	42	32	57	52	50	47	41	31				
	8	1100	519	1500	708	0.09	22	75	72	72	74	70	68	75	73	71	73	69	68	75	73	72	73	70	68	76	73	72	73	70	69	76	74	72	74	70	69				
		700	330	1200	566	0.02	5	71	68	68	68	65	63	70	67	67	67	64	63	71	68	68	69	65	64	72	69	68	69	65	64	72	70	68	69	65	64				
415		196	900	425	0.01	2	66	63	63	62	59	56	66	63	63	62	58	56	67	63	63	62	59	57	68	64	63	63	59	57	69	65	64	63	59	57					
290		137	600	283	0.01	2	61	57	57	56	51	46	59	57	57	55	51	45	61	57	57	56	51	46	62	58	57	56	51	46	63	59	57	56	51	46					
175		83	300	142	0.01	2	60	54	53	51	45	36	59	53	53	51	46	36	59	54	53	51	46	37	59	54	53	51	46	37	59	55	53	51	46	37					
10	1400	661	1500	708	0.02	5	75	72	71	74	70	69	74	72	71	73	69	68	76	73	72	75	71	69	76	74	73	74	71	69	77	74	73	74	70	69					
	660	311	1200	566	0.01	2	73	71	69	69	66	65	70	69	69	69	66	65	72	70	70	70	67	66	72	70	69	70	67	66	72	70	69	69	66	65					
	445	210	900	425	0.01	2	63	56	64	61	57	56	64	58	65	62	59	58	66	63	63	62	59	57	67	62	64	63	59	58	67	61	66	63	60	59					
	335	158	600	283	0.01	2	65	60	61	60	55	49	59	56	59	58	53	48	63	60	59	58	54	49	66	62	61	60	56	51	68	63	63	62	58	54					
	260	123	300	142	0.01	2	64	58	56	54	49	40	62	58	56	54	49	40	62	58	56	55	49	40	62	58	56	54	49	41	62	59	56	54	49	41					
50	4	225	106	2000	944	0.51	127	70	68	65	66	65	62	73	69	66	66	65	62	-	-	-	-	-	73	70	66	66	65	63	73	71	66	65	65	63					
		150	71	1600	755	0.18	45	66	64	61	60	59	56	66	63	61	60	59	56	67	64	61	60	59	56	68	65	62	61	60	69	67	63	62	60	58					
		150	71	1200	566	0.24	60	63	60	56	54	53	49	62	58	57	55	53	50	63	59	57	55	53	49	63	59	57	55	54	64	60	58	56	56	51					
		90	42	800	378	0.08	20	60	53	51	48	45	39	59	53	50	48	45	39	59	53	50	48	45	39	59	53	51	49	46	60	53	52	50	46	42					
		90	42	500	236	0.10	25	60	52	49	45	41	34	58	51	49	45	40	34	58	50	49	45	43	38	57	50	50	46	44	56	51	50	47	45	42					
	6	550	260	2000	944	0.12	30	70	68	65	66	65	62	73	69	66	66	64	62	72	70	67	66	65	64	72	70	67	66	65	64	72	71	66	65	66	65				
		400	189	1600	755	0.04	10	67	64	61	60	59	56	66	63	61	60	59	56	67	64	61	60	57	56	68	66	62	61	61	69	67	63	63	62	61					
		400	189	1200	566	0.09	22	62	59	56	54	53	49	62	59	58	55	53	50	63	59	58	56	55	52	64	61	59	57	57	65	62	60	58	59	59					
		235	111	800	378	0.02	5	58	53	51	48	45	39	59	54	50	48	45	40	59	54	51	49	48	44	60	55	53	51	51	49	62	57	55	53	54	53				
		235	111	500	236	0.04	10	59	52	48	45	40	33	57	52	49	46	40	35	59																					

Performance Data • Radiated Sound Power Levels

Model Series 33SZ • Series Flow • FPCWTU (DOAS)

Unit Size	Inlet Size	Primary Airflow		Fan Airflow		Min. inlet ΔPs	Fan and 100% Primary Air-Sound Power Octave Bands @ Inlet pressure (ΔPs) shown																														
							Fan Only							Minimum ΔPs							0.5" w.g. Inlet Static							1.0" w.g. Inlet Static							1.5" w.g. Inlet Static		
		cfm	l/s	cfm	l/s	"w.g. Pa	2	3	4	5	6	7	2	3	4	5	6	7	2	3	4	5	6	7	2	3	4	5	6	7	2	3	4	5	6	7	
30	4	225	106	1250	590	0.42	104	71	70	67	67	61	53	70	68	65	66	59	49	70	68	65	66	59	51	71	68	66	66	59	53	72	69	66	66	59	55
		150	71	1000	472	0.15	37	68	65	63	63	56	46	67	64	62	63	55	46	67	64	62	62	54	47	68	64	62	62	55	48	69	65	62	62	55	49
		150	71	800	378	0.20	50	66	61	60	60	51	41	65	61	59	59	50	40	65	60	59	59	50	42	66	61	59	59	51	43	67	61	59	59	51	45
		90	42	500	236	0.06	15	57	51	52	51	40	28	59	52	52	51	40	30	59	52	52	50	40	35	59	53	52	50	41	36	59	54	53	50	41	38
		90	42	250	118	0.10	25	49	48	48	44	33	17	47	48	49	44	34	25	50	49	49	45	36	34	49	49	49	45	37	35	48	49	50	46	38	37
	6	550	260	1250	590	0.12	30	71	70	67	67	61	53	70	68	65	66	59	50	69	68	65	66	59	52	70	68	66	66	59	55	70	68	66	66	59	58
		400	189	1000	472	0.06	15	68	65	63	63	56	46	67	64	62	63	55	46	67	64	62	62	55	48	67	64	62	62	55	50	67	64	62	62	55	52
		400	189	800	378	0.10	25	66	61	60	60	51	41	62	59	58	58	50	39	63	59	59	59	50	44	64	61	59	59	52	49	66	62	60	60	54	54
		235	111	500	236	0.03	6	57	51	52	51	40	28	57	52	52	51	40	30	60	54	53	52	43	40	62	57	55	54	47	46	64	60	57	56	51	53
		190	90	250	118	0.03	7	49	48	48	44	33	17	48	48	49	44	34	21	53	50	49	46	38	34	53	51	51	48	41	39	54	53	53	49	45	44
	8	1100	519	1250	590	0.09	22	73	70	67	67	61	53	71	68	66	66	59	50	71	68	66	66	59	53	71	69	66	66	59	56	72	69	67	66	60	59
		700	330	1000	472	0.01	2	70	66	63	63	56	46	67	63	62	62	54	45	67	63	62	62	54	49	68	64	62	62	55	53	69	65	63	63	56	57
		415	196	800	378	0.01	2	67	61	60	59	51	40	64	59	58	58	49	39	64	60	59	58	50	44	65	61	59	59	52	48	67	62	60	59	53	53
		250	118	500	236	0.01	2	56	51	52	50	40	28	57	52	52	50	40	30	58	52	52	51	42	38	59	54	53	51	45	43	60	56	54	52	48	47
		190	90	250	118	0.01	2	48	48	49	44	33	17	47	48	48	44	33	22	52	49	49	45	38	34	53	51	50	47	41	39	54	52	52	48	45	43
40	4	225	106	1500	708	0.56	139	71	70	68	68	69	65	70	69	67	67	68	65	-	-	-	-	-	70	70	67	69	69	65	71	70	68	69	70	66	
		150	71	1200	566	0.21	52	66	66	64	64	64	60	69	68	65	66	65	61	70	69	66	67	66	62	69	69	66	67	66	62	69	69	66	67	67	63
		150	71	900	425	0.26	65	61	59	58	58	56	52	63	61	59	60	58	54	63	63	60	61	59	55	63	63	60	61	59	55	63	62	61	61	59	55
		90	42	600	283	0.08	20	58	57	56	54	51	45	61	59	58	56	54	48	59	59	59	57	53	47	57	58	58	56	53	47	56	57	57	56	53	46
		90	42	300	142	0.10	25	55	53	52	49	45	37	58	56	55	52	48	42	58	56	55	52	47	38	58	56	55	52	48	41	58	57	56	53	49	44
	6	550	260	1500	708	0.31	77	71	70	68	68	69	65	69	68	66	66	66	63	69	69	66	67	67	64	70	69	67	68	68	65	71	70	68	68	68	66
		400	189	1200	566	0.07	17	66	66	64	64	64	60	65	65	63	63	62	58	66	65	63	63	62	59	67	66	64	64	63	61	68	67	64	64	64	62
		400	189	900	425	0.09	22	61	59	58	58	56	52	58	58	57	56	55	51	60	60	58	58	56	53	63	61	59	59	58	56	65	62	60	60	60	60
		235	111	600	283	0.03	7	58	57	56	54	51	45	55	54	54	52	49	42	56	55	54	52	50	45	56	55	54	53	52	48	56	55	54	54	54	50
		145	68	300	142	0.02	5	55	53	52	49	45	37	56	51	50	47	42	35	56	52	51	47	45	39	56	53	51	49	46	42	57	53	52	50	48	45
	8	1100	519	1500	708	0.09	22	69	69	67	67	67	64	70	69	67	67	67	64	70	70	68	68	68	64	71	70	68	68	68	66	72	71	68	69	68	67
		700	330	1200	566	0.02	5	65	65	63	63	62	58	65	64	63	63	62	58	65	65	63	63	63	59	67	66	64	64	63	61	68	67	65	65	64	63
		415	196	900	425	0.01	2	62	60	59	58	56	52	60	59	58	57	56	51	61	60	59	58	57	53	63	61	59	59	58	56	65	62	60	60	60	59
		290	137	600	283	0.01	2	56	54	54	51	49	42	55	54	53	51	48	42	58	55	54	52	51	46	59	56	55	53	53	50	60	57	56	55	56	54
		175	83	300	142	0.01	2	53	51	51	46	42	33	53	51	51	46	42	33	54	51	51	48	45	38	54	52	51	49	47	42	54	52	52	50	50	46
10	1400	661	1500	708	0.02	5	69	69	67	67	67	64	71	69	66	67	67	64	71	69	67	67	67	64	72	70	68	68	68	65	73	71	69	69	68	67	
	660	311	1200	566	0.01	2	65	65	63	63	62	58	64	64	62	62	61	58	64	64	63	63	62	58	66	66	63	63	63	60	67	67	64	64	64	62	
	445	210	900	425	0.01	2	60	59	58	57	56	51	56	58	57	56	55	50	59	60	58	57	56	52	60	60	59	58	58	55	62	61	59	59	60	58	
	335	158	600	283	0.01	2	55	54	54	52	49	42	54	54	54	51	48	41	56	55	54	52	50	44	55	55	54	52	52	47	55	55	54	53	55	50	
	260	123	300	142	0.01	2	54	51	50	47	42	34	55	51	50	47	42	35	55	51	50	48	46	40	55	52	51	50	49	44	57	54	53	52	52	49	
50	4	225	106	2000	944	0.51	127	70	68	65	66	65	62	73	69	66	66	65	62	-	-	-	-	-	73	70	66	66	65	63	73	71	66	65	65	63	
		150	71	1600	755	0.18	45	66	64	61	60	59	56	66	63	61	60	59	56	67	64	61	60	59	56	68	65	62	61	60	57	69	67	63	62	60	58
		150	71	1200	566	0.24	60	63	60	56	54	53	49	62	58	57	55	53	50	63	59	57	55	53	49	63	59	57	55	54	50	64	60	58	56	56	51
		90	42	800	378	0.08	20	60	53	51	48	45	39	59	53	50	48	45	39	59	53	50	48	45	40	59	53	51	49	46	41	60	53	52	50	46	42
		90	42	500	236	0.10	25	60	52	49	45	41	34	58	51	49	45	40	34	58	50	49	45	43	38	58	50	50	46	44	40	56	51	51	47	45	42
	6	550	260	2000	944	0.12	30	70	68	65	66	65	62	73	69	66	66	64	62	72	70	67	66	65	64	72	70	67	66	65	64	72	71	66	65	66	65
		400	189	1600	755	0.04	10	67	64	61	60	59	56	66	63	61	60	59	56	67	64	61	60	60	57	68	66	62	61	61	59	68	67	63	63	62	61
		400	189	1200	566	0.09	22	62	59	56	54	53	49	62	59	58	55	53	50	63	59	58	56	55	52	64	61	59	57	57	55	65	62	60	58	59	59
		235	111	800	378	0.02	5	58	53	51	48	45	39	59	54	50	48	45	40	59	54	51	49	48	44	60	55	53									

Performance Notes

Model 33SZ • Series Flow • FPCWTU (DOAS)

Explanation of NC Levels:

1. NC levels are calculated from the published raw data and based on procedures outlined in AHRI Standard 885, Appendix E.
2. Discharge sound attenuation deductions are based on environmental effect, duct lining, branch power division, insulated flex duct, end reflection and space effect and are as follows:

Discharge attenuation	Octave Band						
	2	3	4	5	6	7	
< 300 cfm	24	28	39	53	59	40	
300 – 700 cfm	27	29	40	51	53	39	
> 700 cfm	29	30	41	51	52	39	

3. Radiated sound attenuation deductions are based on a mineral tile ceiling and environmental effect and are as follows:

Radiated attenuation	Octave Band						
	2	3	4	5	6	7	
Total dB reduction	18	19	20	26	31	36	

Performance Notes for Sound Power Levels:

1. Discharge sound power is the noise emitted from the unit discharge into the downstream duct.
2. Radiated sound power is the breakout noise transmitted through the unit casing walls.
3. Sound power levels are in decibels, dB re 10⁻¹² watts.
4. All sound data listed by octave bands is raw data without any corrections for room absorption or duct attenuation. Dash (-) in space indicates sound power level is less than 20 dB or equal to background.
5. Minimum inlet ΔPs is the minimum operating pressure of the primary air valve.

4. Min. inlet ΔPs is the minimum static pressure required to achieve rated airflow (damper full open).
5. Dash (-) in space denotes an NC level of less than 20.
6. Discharge (external) static pressure is 0.25" w.g. (63 Pa) in all cases.
7. For a detailed explanation of the attenuation factors and the procedures for calculating room NC levels, please refer to the Performance Data Explanation in this section and the Acoustical Engineering Guidelines in the Engineering Section of this catalog.

6. Asterisk (*) in space indicates that the minimum inlet static pressure requirement is greater than 0.5" w.g. (125 Pa) at rated airflow.
7. Data derived from independent tests conducted in accordance with ANSI/ASHRAE Standard 130.

Performance Data • Sensible Chilled Water Coil

Models: 33SZ, 33SZE, 33SZW • FPCWTU (DOAS) • Series Flow

Unit Size 30

2 Row (multi-circuit)

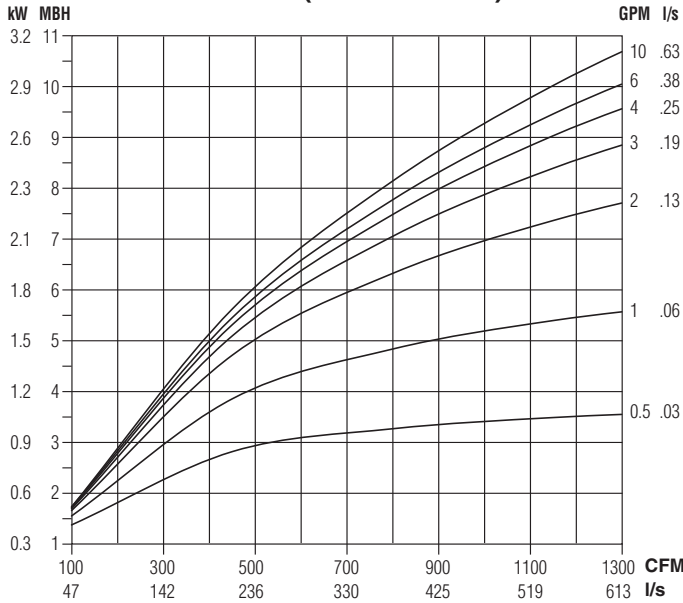

4 Row (multi-circuit)

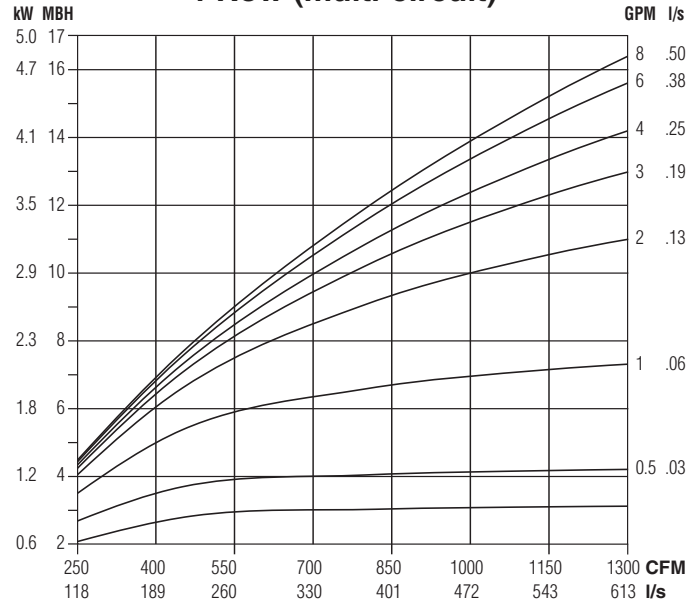

6 Row (multi-circuit)

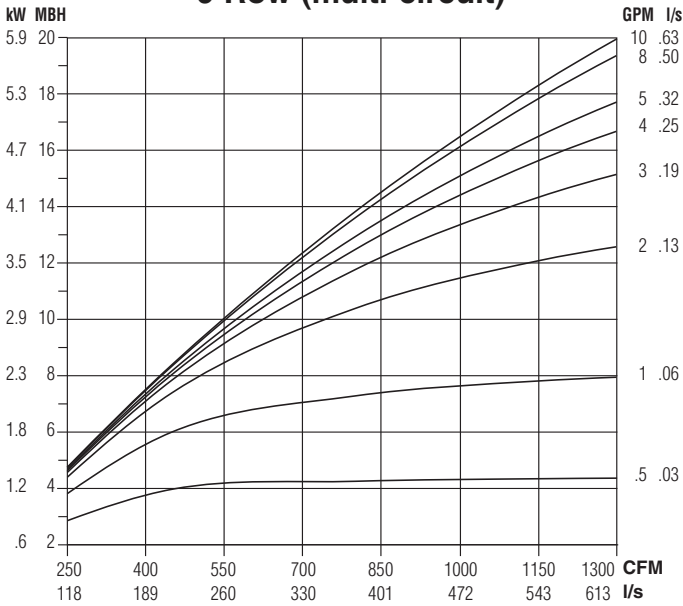

Water Pressure Drop

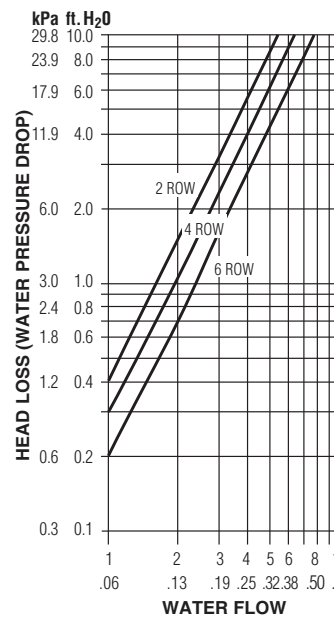

Air Pressure Drop

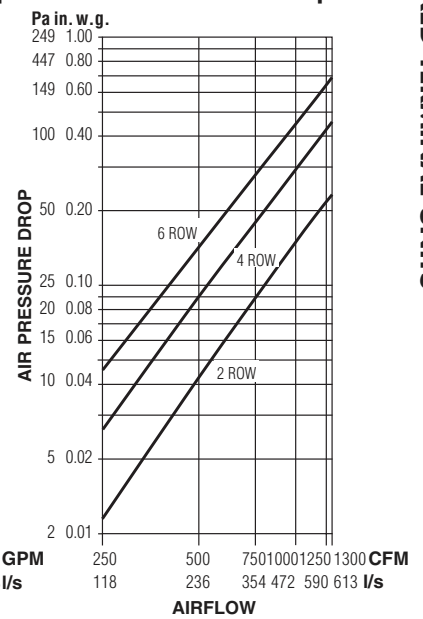

NOTES:

1. Capacities are in MBH (kW), **thousands of Btu per hour (kiloWatts)**.

2. MBH (kW) values are based on:
57°F (32°C) Entering Water Temperature (EWT) and 75°F (42°C) Entering Air

Temperature (EAT). Entering water temperature must be above return air dew point to prevent condensation.

3. Air Temperature Rise.

$$ATR (°F) = 927 \times \frac{MBH}{cfm}, \quad ATR (°C) = 829 \times \frac{kW}{I/s}$$

4. Water Temp. Drop.

$$WTD (°F) = 2.04 \times \frac{MBH}{GPM}, \quad WTD (°C) = .224 \times \frac{kW}{I/s}$$

5. Connections: 2, 4 & 6 Row: 7/8" (22) O.D. male solder.

Altitude Correction Factors:

Attitude (ft.)	0	1000	2000	3000	4000	5000	6000	7000
Air Density (lb./cu.ft.)	0.075	0.072	0.070	0.067	0.065	0.063	0.060	0.058
Sensible Capacity	1000	0.960	0.930	0.900	0.860	0.830	0.800	0.700

Performance Data • Hot Water Coil

Model: 33SZW • FPCWTU (DOAS) • Series Flow

Unit Size 30

1 Row (single-circuit)

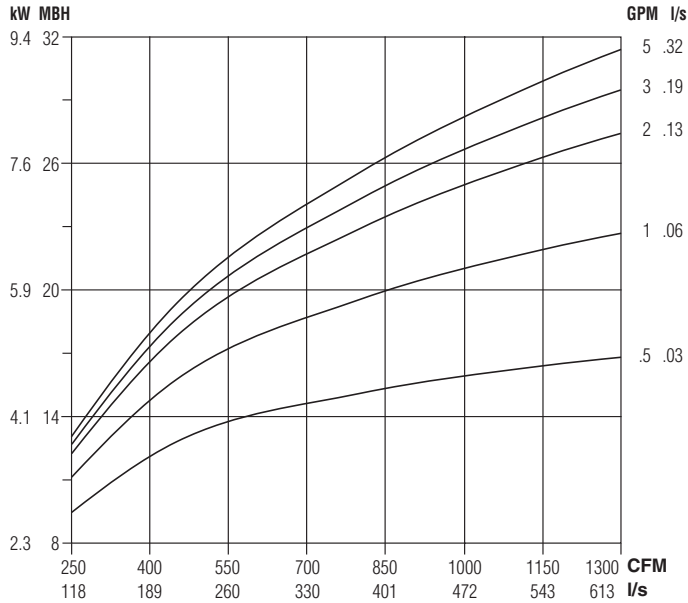

2 Row (multi-circuit)

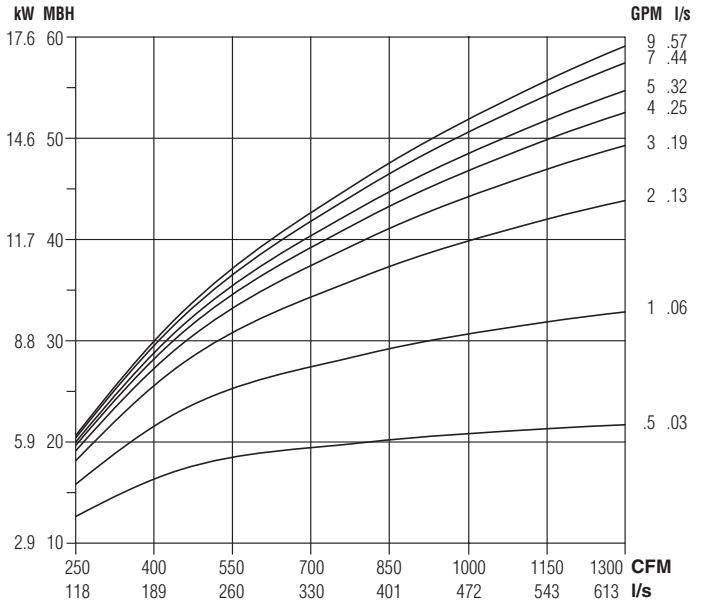

Water Pressure Drop

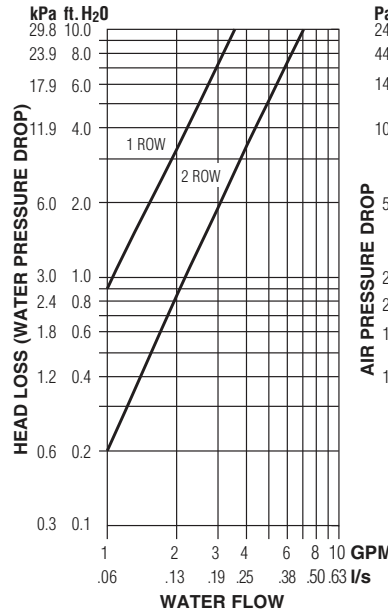

Air Pressure Drop

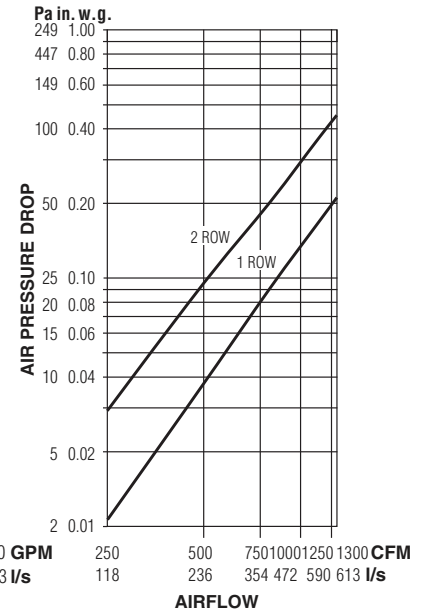

NOTES:

- Capacities are in MBH (kW), *thousands of Btu per hour (kiloWatts)*.
- MBH (kW) values are based on a Δt (temperature difference) of 120°F (67°C) between entering air and entering water. For other Δt 's; multiply the MBH (kW) values by the factors below.

- Air Temperature Rise.

$$ATR (^\circ F) = 927 \times \frac{\text{MBH}}{\text{cfm}}, \quad ATR (^\circ C) = 829 \times \frac{\text{kW}}{\text{l/s}}$$

- Water Temp. Drop.

$$WTD (^\circ F) = 2.04 \times \frac{\text{MBH}}{\text{GPM}}, \quad WTD (^\circ C) = .224 \times \frac{\text{kW}}{\text{l/s}}$$

- Connections: 1 Row 1/2" (13) and 2 Row 5/8" (16); O.D. male solder.

Correction factors at other entering conditions:

Δt (°C)	50 (28)	60 (33)	70 (39)	80 (44)	90 (50)	100 (56)	110 (61)	120 (67)	130 (72)	140 (78)	150 (83)
Factor	.417 (.418)	.500 (.493)	.583 (.582)	.667 (.657)	.750 (.746)	.833 (.836)	.917 (.910)	1.00 (1.00)	1.08 (1.08)	1.17 (1.16)	1.25 (1.24)

Altitude Correction Factors:

Altitude ft. (m)	Sensible Heat Factor
0 (0)	1.00
2000 (610)	0.94
3000 (914)	0.90
4000 (1219)	0.87
5000 (1524)	0.84
6000 (1829)	0.81
7000 (2134)	0.78



Performance Data • Sensible Chilled Water Coil

Models: 33SZ, 33SZE, 33SZW • FPCWTU (DOAS) • Series Flow

Unit Size 40

2 Row (multi-circuit)

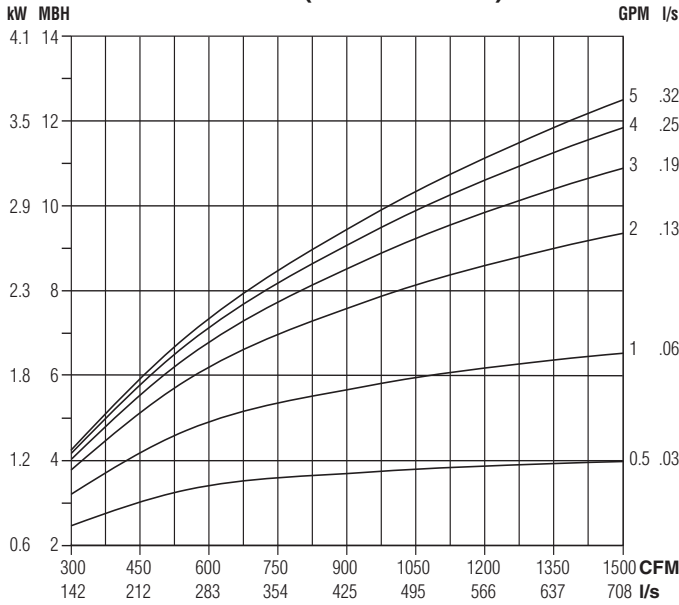

4 Row (multi-circuit)

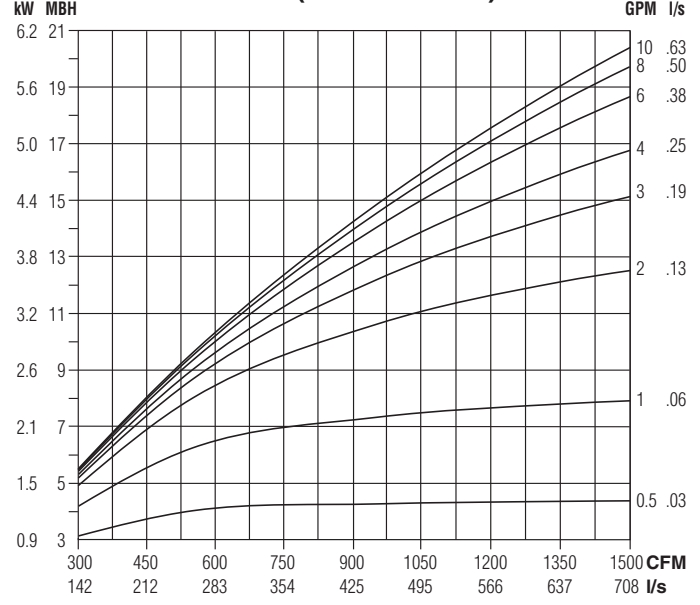

6 Row (multi-circuit)

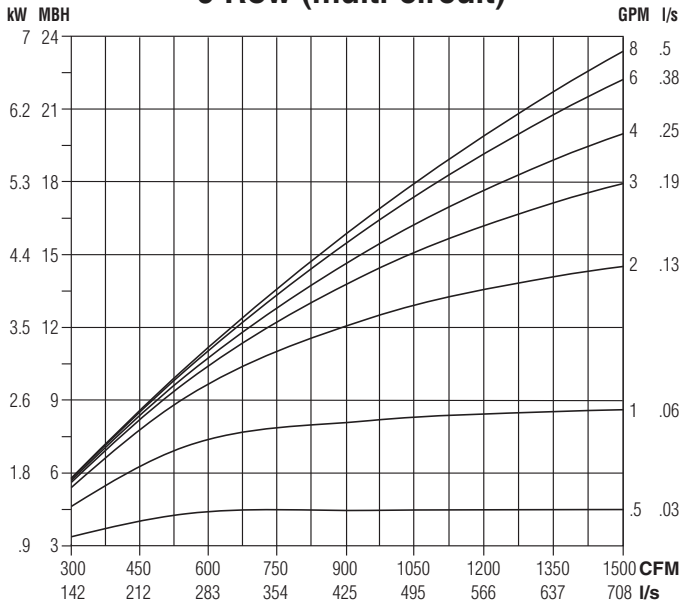

Water Pressure Drop

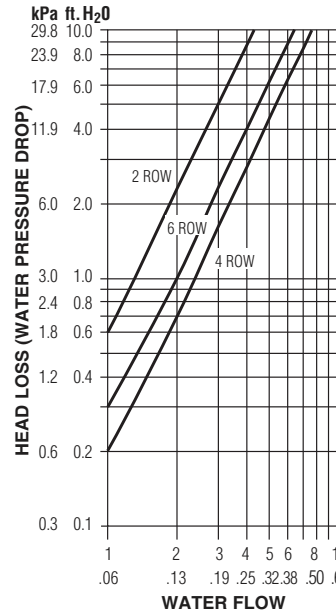

Air Pressure Drop

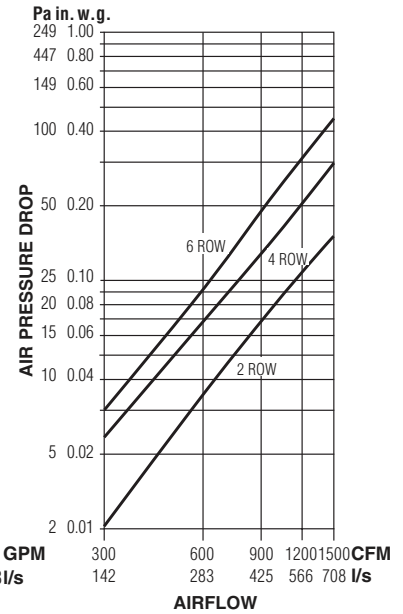

NOTES:

- Capacities are in MBH (kW), *thousands of Btu per hour (kiloWatts)*.
- MBH (kW) values are based on:
57°F (32°C) Entering Water Temperature (EWT) and 75°F (42°C) Entering Air

Temperature (EAT). Entering water temperature must be above return air dew point to prevent condensation.

3. Air Temperature Rise.
 $ATR (°F) = 927 \times \frac{MBH}{cfm}$, $ATR (°C) = 829 \times \frac{kW}{l/s}$

- Water Temp. Drop.
 $WTD (°F) = 2.04 \times \frac{MBH}{GPM}$, $WTD (°C) = .224 \times \frac{kW}{l/s}$
- Connections: 2, 4 & 6 Row: 7/8" (22) O.D. male solder.

Altitude Correction Factors:

Attitude (ft.)	0	1000	2000	3000	4000	5000	6000	7000
Air Density (lb./cu.ft.)	0.075	0.072	0.070	0.067	0.065	0.063	0.060	0.058
Sensible Capacity	1000	0.960	0.930	0.900	0.860	0.830	0.800	0.700

Performance Data • Hot Water Coil

Model: 33SZW • FPCWTU (DOAS) • Series Flow

Unit Size 40

1 Row (single-circuit)

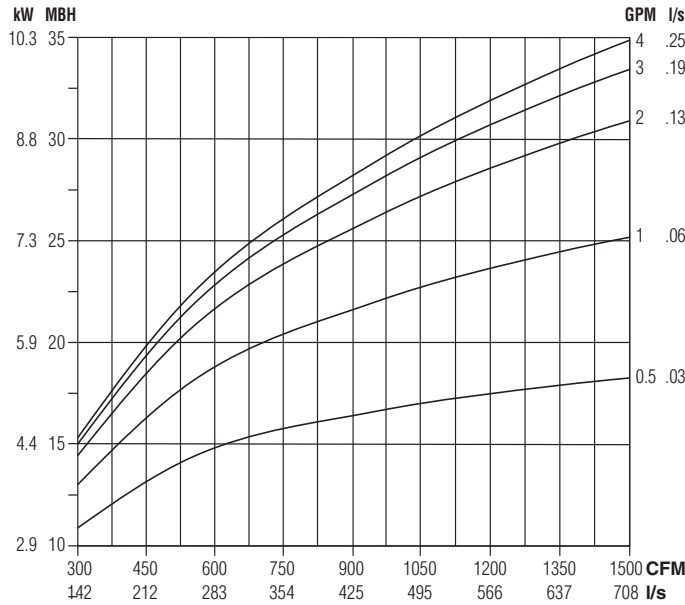

2 Row (multi-circuit)

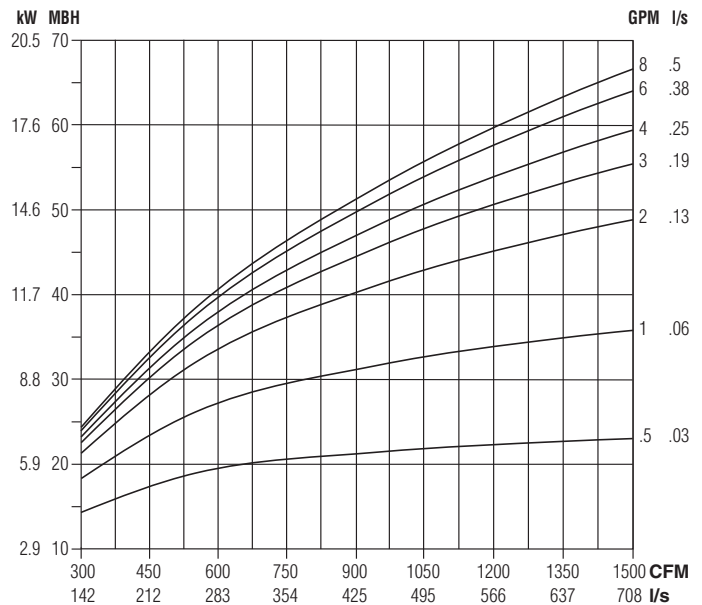

Water Pressure Drop

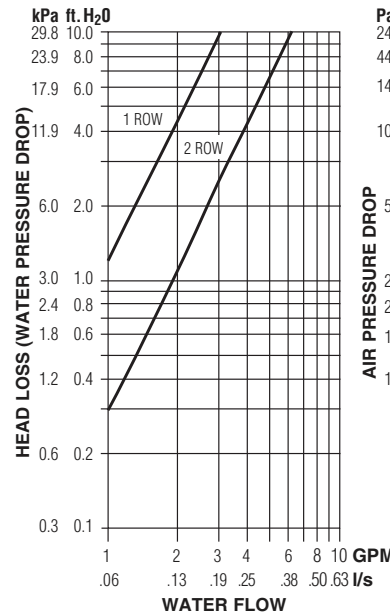

Air Pressure Drop

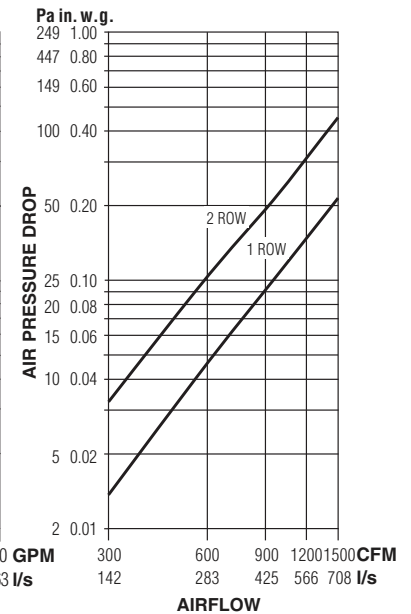

NOTES:

- Capacities are in MBH (kW), *thousands of Btu per hour (kiloWatts)*.
- MBH (kW) values are based on a Δt (temperature difference) of 120°F (67°C) between entering air and entering water. For other Δt 's; multiply the MBH (kW) values by the factors below.

- Air Temperature Rise.

$$\text{ATR (}^\circ\text{F)} = 927 \times \frac{\text{MBH}}{\text{cfm}}, \text{ ATR (}^\circ\text{C)} = 829 \times \frac{\text{kW}}{\text{l/s}}$$

- Water Temp. Drop.

$$\text{WTD (}^\circ\text{F)} = 2.04 \times \frac{\text{MBH}}{\text{GPM}}, \text{ WTD (}^\circ\text{C)} = .224 \times \frac{\text{kW}}{\text{l/s}}$$

- Connections: 1 Row 1/2" (13) and 2 Row 7/8" (22); O.D. male solder.

Altitude Correction Factors:

Altitude ft. (m)	Sensible Heat Factor
0 (0)	1.00
2000 (610)	0.94
3000 (914)	0.90
4000 (1219)	0.87
5000 (1524)	0.84
6000 (1829)	0.81
7000 (2134)	0.78

Correction factors at other entering conditions:

Δt °F (°C)	50 (28)	60 (33)	70 (39)	80 (44)	90 (50)	100 (56)	110 (61)	120 (67)	130 (72)	140 (78)	150 (83)
Factor	.417 (.418)	.500 (.493)	.583 (.582)	.667 (.657)	.750 (.746)	.833 (.836)	.917 (.910)	1.00 (1.00)	1.08 (1.08)	1.17 (1.16)	1.25 (1.24)



Performance Data • Sensible Chilled Water Coil

Models: 33SZ, 33SZE, 33SZW • FPCWTU (DOAS) • Series Flow

Unit Size 50

2 Row (multi-circuit)

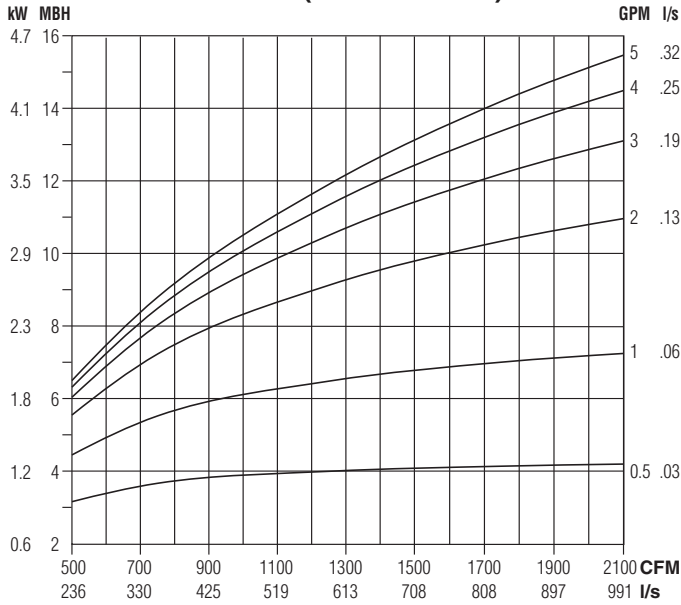

4 Row (multi-circuit)

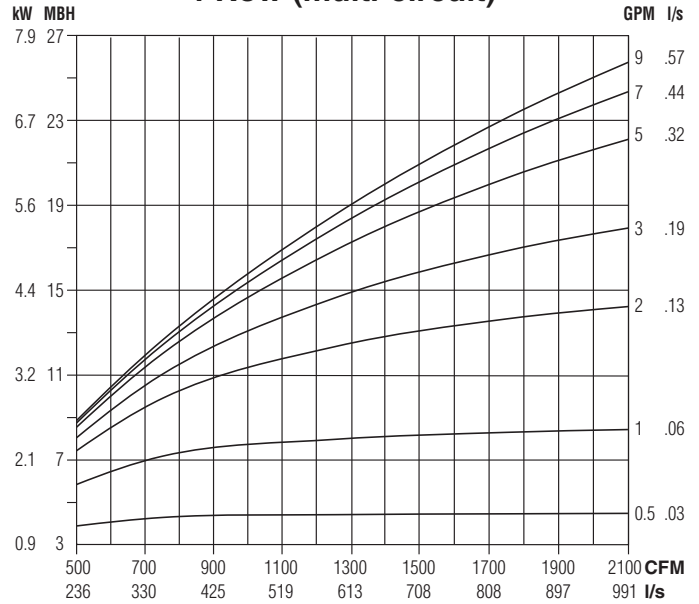

6 Row (multi-circuit)

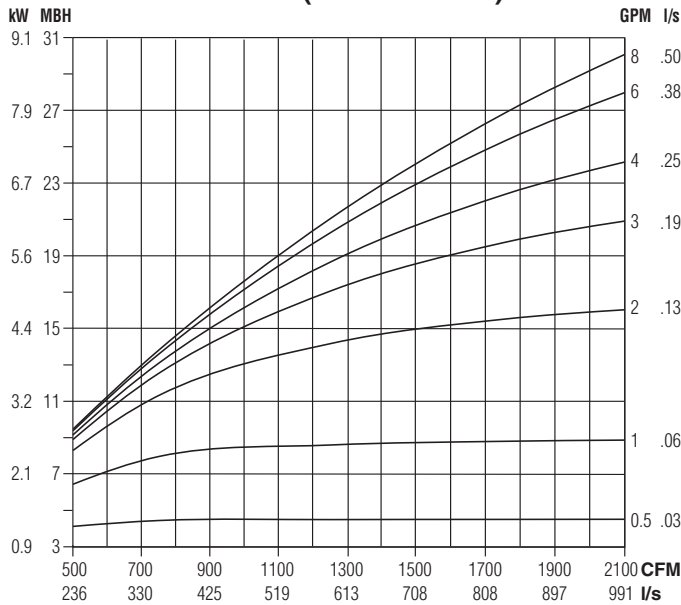

Water Pressure Drop

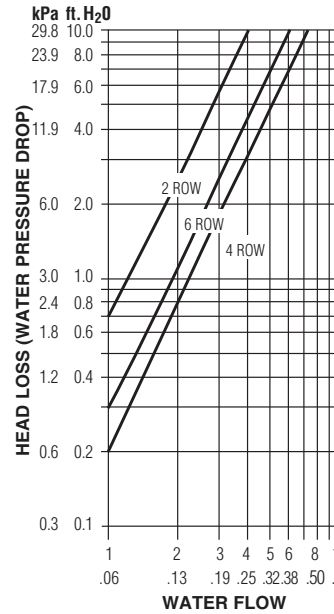

Air Pressure Drop

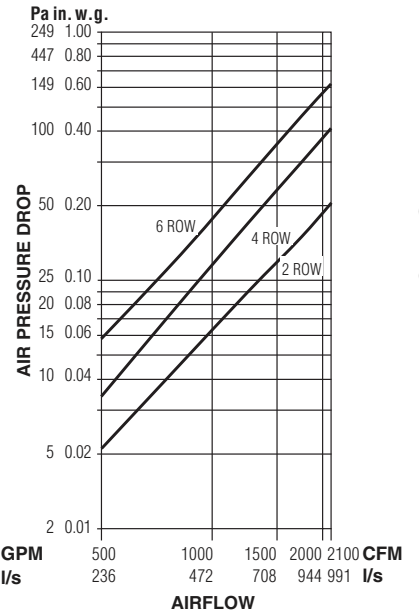

NOTES:

- Capacities are in MBH (kW), *thousands of Btu per hour (kiloWatts)*.
- MBH (kW) values are based on:
57°F (32°C) Entering Water Temperature (EWT) and 75°F (42°C) Entering Air

Temperature (EAT). Entering water temperature must be above return air dew point to prevent condensation.

- Air Temperature Rise.

$$ATR (°F) = 927 \times \frac{MBH}{cfm}, ATR (°C) = 829 \times \frac{kW}{I/s}$$

- Water Temp. Drop.

$$WTD (°F) = 2.04 \times \frac{MBH}{GPM}, WTD (°C) = .224 \times \frac{kW}{I/s}$$

- Connections: 2, 4 & 6 Row: 7/8" (22) O.D. male solder.

Altitude Correction Factors:

Attitude (ft.)	0	1000	2000	3000	4000	5000	6000	7000
Air Density (lb./cu.ft.)	0.075	0.072	0.070	0.067	0.065	0.063	0.060	0.058
Sensible Capacity	1000	0.960	0.930	0.900	0.860	0.830	0.800	0.700

Performance Data • Hot Water Coil

Model: 33SZW • FPCWTU (DOAS) • Series Flow

Unit Size 50

1 Row (multi-circuit)

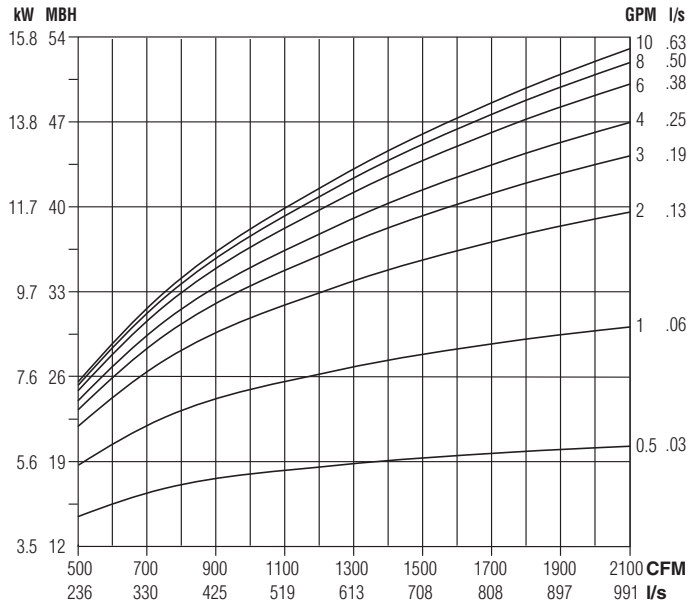

2 Row (multi-circuit)

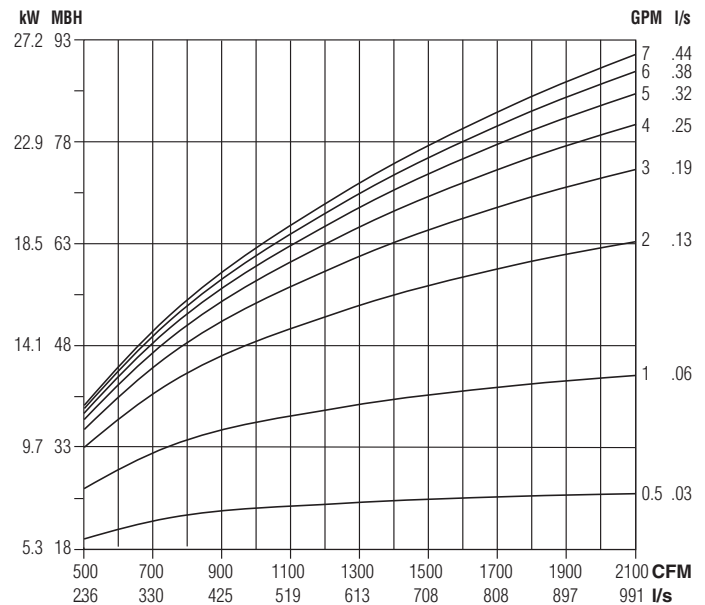

Water Pressure Drop

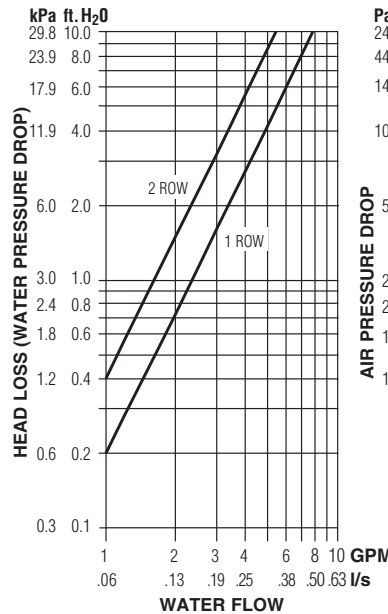

Air Pressure Drop

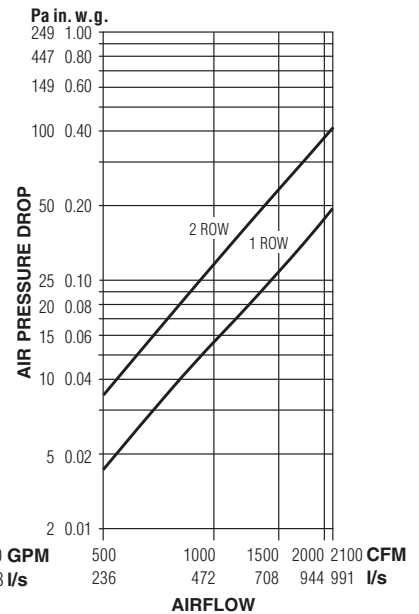

NOTES:

- Capacities are in MBH (kW), *thousands of Btu per hour (kiloWatts)*.
- MBH (kW) values are based on a Δt (temperature difference) of 120°F (67°C) between entering air and entering water. For other Δt 's; multiply the MBH (kW) values by the factors below.

- Air Temperature Rise.

$$\text{ATR (°F)} = 927 \times \frac{\text{MBH}}{\text{cfm}}, \text{ATR (°C)} = 829 \times \frac{\text{kW}}{\text{l/s}}$$

- Water Temp. Drop.

$$\text{WTD (°F)} = 2.04 \times \frac{\text{MBH}}{\text{GPM}}, \text{WTD (°C)} = .224 \times \frac{\text{kW}}{\text{l/s}}$$

- Connections: 1 Row 1/2" (13) and 2 Row 7/8" (22); O.D. male solder.

Altitude Correction Factors:

Altitude ft. (m)	Sensible Heat Factor
0 (0)	1.00
2000 (610)	0.94
3000 (914)	0.90
4000 (1219)	0.87
5000 (1524)	0.84
6000 (1829)	0.81
7000 (2134)	0.78

Correction factors at other entering conditions:

Δt °F (°C)	50 (28)	60 (33)	70 (39)	80 (44)	90 (50)	100 (56)	110 (61)	120 (67)	130 (72)	140 (78)	150 (83)
Factor	.417 (.418)	.500 (.493)	.583 (.582)	.667 (.657)	.750 (.746)	.833 (.836)	.917 (.910)	1.00 (1.00)	1.08 (1.08)	1.17 (1.16)	1.25 (1.24)

