

Model 1602D Thinline drainable blade louvers combine excellent weather protection with pleasing aesthetics. The drainable blade design is enhanced by the drainable head feature, which utilizes a large rain gutter that diverts collected water down concealed side downspouts and out through the sill. This drainable louver delivers outstanding performance where a 4" (102) or 6" (152) louver is not practical. Suitable for use in ventilation, exhaust and low to medium velocity intake applications where water penetration is a concern, ideal for use in thin wall and curtain wall applications or A/C units where a full depth louver cannot be used. Available in channel, flanged, or glazing adaptor type, the 2" (51) deep frame installs easily in most common wall and mechanical configurations.

**STANDARD CONSTRUCTION:**

- FRAME:** 2" (51) deep, Type 6063-T6 extruded aluminum, .060" (1.5) nominal wall thickness. Integral downspouts and caulking slot provided.
- BLADES:** Type 6063-T6 extruded aluminum, .060" (1.5) nominal wall thickness, with reinforcing bosses.
- BLADE ANGLE:** Fixed at 45 degrees.
- BLADE SPACING:** Approximately 2 1/4" (57) on centers.
- BLADE SUPPORT BRACKETS:** Concealed type, factory installed on rear of louver on maximum 50" (1270) centers. Reinforced with 1" x 1" (25 x 25) angle (adds approx. 1" [25] to overall louver depth).
- MULLIONS:** Concealed type allowing continuous line appearance up to 120" (3048) wide. Larger assemblies require separate visible frames with downspouts.
- SCREEN:** 3/4" x .051 (19 x 1.3) expanded, flattened aluminum bird screen in removable frame, inside (rear) mount (adds approximately 3/8" [10] to louver depth).
- FINISH:** Mill.
- MINIMUM SIZE:** 8" W x 8" H (203 x 203).
- MAXIMUM SINGLE SECTION SIZE:** 120" W x 84" H (3048 x 2134) or 84" W x 120" H (2134 x 3048). 70 sq. ft. (6.5m<sup>2</sup>). Larger louvers will require field assembly of smaller sections.

**OPTIONS:**

- |   |  |
|---|--|
| <input type="checkbox"/> <b>FL15</b> Flanged Frame, 1 1/2" (38).  | <input type="checkbox"/> <b>WE</b> Welded Construction.      |
| <input type="checkbox"/> <b>FL20</b> Flanged Frame, 2" (51).      | <input type="checkbox"/> <b>ESI</b> Extended Sill.           |
| <input type="checkbox"/> <b>GA</b> Glazing Adaptor.               | <input type="checkbox"/> <b>FR1</b> 1" (25) Filter Rack.     |
| <input type="checkbox"/> <b>BSSS</b> Type 304 S.S. Bird Screen.   | <input type="checkbox"/> <b>FR2</b> 2" (51) Filter Rack.     |
| <input type="checkbox"/> <b>BSN</b> No Bird Screen.               | <input type="checkbox"/> <b>PACA</b> Perimeter Anchor Clips. |
| <input type="checkbox"/> <b>ISA</b> Aluminum Insect Screen.       | <input type="checkbox"/> <b>Other:</b> _____.                |
| <input type="checkbox"/> <b>ISSS</b> Type 304 S.S. Insect Screen. |  |

**OPTIONAL FINISHES:**

- PC3** Powder Coat AAMA 2603. Color: \_\_\_\_\_.
- PC4** High Performance Powder Coat AAMA 2604 (Equivalent to 50% Kynar<sup>®</sup>). Color: \_\_\_\_\_.
- PC5** Fluoropolymer Powder Coat AAMA 2605 (Equivalent to 70% Kynar<sup>®</sup>). Color: \_\_\_\_\_.
- PCC** Prime Coat.
- AN04** Clear Anodized 204-R1.
- AN15** Clear Anodized 215-R1.

**Color Anodized:**

- |  |   |
|--|---|
| <input type="checkbox"/> <b>ANLB</b> Light Bronze. | <input type="checkbox"/> <b>ANMB</b> Medium Bronze. |
| <input type="checkbox"/> <b>ANDB</b> Dark Bronze.  | <input type="checkbox"/> <b>ANBK</b> Black.         |

**OPTIONAL W x H SIZING** (1/4" [6.5] Undersize standard):

- U00** Exact Size.
- U38** Undersize 3/8" (9.5).
- U50** Undersize 1/2" (12.7).

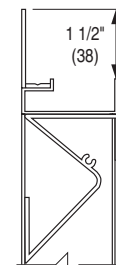
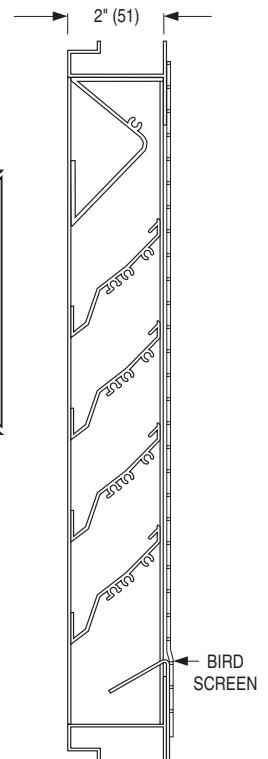
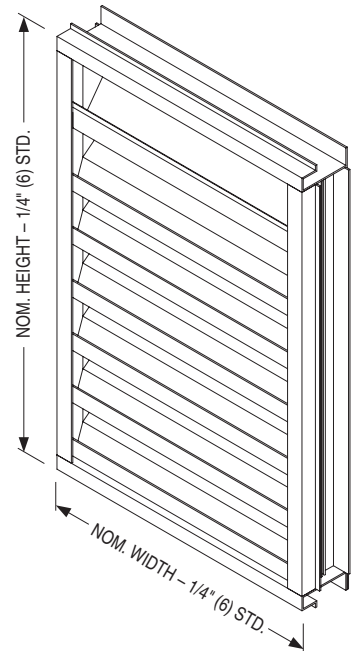

OPT. FLANGED FRAME  
(FL15 STD.)

**SCHEDULE TYPE:**
**PROJECT:**
**ENGINEER:**
**CONTRACTOR:**
**DATE**
**B SERIES**
**SUPERSEDES**
**DRAWING NO.**
**3 - 12 - 24**
**1600**
**8 - 23 - 23**
**1602D**

Page 1 of 3

Dimensions are in inches (mm).



**EXTRUDED ALUMINUM STATIONARY LOUVER**  
**2" (51) DEEP • DRAINABLE BLADE**  
**PERFORMANCE DATA**  
**MODEL: 1602D**

**FREE AREA in Square Feet and Square Meters**

		Width in Inches and Meters																			
		8	12	18	24	30	36	42	48	54	60	66	72	78	84	90	96	102	108	114	120
		0.20	0.30	0.46	0.61	0.76	0.91	1.07	1.22	1.37	1.52	1.68	1.83	1.98	2.13	2.29	2.44	2.59	2.74	2.90	3.05
Height in Inches and Meters	8 0.20	0.07 0.01	0.12 0.01	0.19 0.02	0.27 0.02	0.34 0.03	0.41 0.04	0.49 0.05	0.56 0.05	0.63 0.06	0.70 0.07	0.78 0.08	0.85 0.09	0.92 0.10	1.00 0.09	1.07 0.10	1.14 0.11	1.21 0.11	1.29 0.12	1.36 0.13	1.43 0.13
	12 0.30	0.15 0.01	0.25 0.02	0.40 0.04	0.55 0.05	0.70 0.07	0.85 0.08	1.01 0.09	1.16 0.11	1.31 0.12	1.46 0.14	1.61 0.15	1.76 0.16	1.91 0.18	2.06 0.19	2.21 0.21	2.36 0.22	2.51 0.23	2.67 0.25	2.82 0.26	2.97 0.28
	18 0.46	0.27 0.03	0.45 0.04	0.73 0.07	1.00 0.09	1.27 0.12	1.54 0.14	1.81 0.17	2.08 0.19	2.36 0.22	2.63 0.24	2.90 0.27	3.17 0.29	3.44 0.32	3.72 0.35	3.99 0.37	4.26 0.40	4.53 0.42	4.80 0.45	5.08 0.47	5.35 0.50
	24 0.61	0.39 0.04	0.65 0.06	1.05 0.10	1.44 0.13	1.83 0.17	2.22 0.21	2.61 0.24	3.01 0.28	3.40 0.32	3.79 0.35	4.18 0.39	4.57 0.42	4.97 0.46	5.36 0.50	5.76 0.53	6.14 0.57	6.53 0.61	6.93 0.64	7.32 0.68	7.71 0.72
	30 0.76	0.54 0.05	0.90 0.08	1.44 0.13	1.98 0.18	2.52 0.23	3.06 0.28	3.60 0.33	4.14 0.38	4.68 0.43	5.22 0.49	5.76 0.54	6.30 0.59	6.84 0.64	7.38 0.69	7.92 0.74	8.46 0.79	9.00 0.84	9.54 0.89	10.08 0.94	10.62 0.99
	36 0.36	0.66 0.06	1.10 0.10	1.76 0.16	2.42 0.22	3.08 0.29	3.74 0.35	4.40 0.41	5.06 0.47	5.72 0.53	6.38 0.59	7.04 0.65	7.70 0.72	8.36 0.78	9.02 0.84	9.68 0.90	10.34 0.96	11.00 1.02	11.66 1.08	12.32 1.14	12.98 1.21
	42 1.07	0.78 0.07	1.30 0.12	2.08 0.19	2.86 0.27	3.64 0.34	4.42 0.41	5.20 0.48	5.98 0.56	6.76 0.63	7.54 0.70	8.32 0.77	9.10 0.85	9.88 0.92	10.66 0.99	11.44 1.06	12.22 1.14	13.00 1.21	13.78 1.28	14.56 1.35	15.34 1.43
	48 1.22	0.93 0.09	1.55 0.14	2.48 0.23	3.41 0.32	4.34 0.40	5.27 0.49	6.20 0.58	6.91 0.64	8.06 0.75	8.99 0.84	9.92 0.94	10.84 1.04	11.77 1.14	12.70 1.23	13.63 1.33	14.56 1.43	15.49 1.53	16.42 1.62	17.35 1.72	18.28 1.82
	54 1.37	1.05 0.10	1.75 0.16	2.80 0.26	3.85 0.36	4.90 0.45	5.95 0.55	7.00 0.65	8.05 0.75	9.10 0.84	10.15 0.94	11.19 1.04	12.24 1.14	13.29 1.23	14.34 1.33	15.39 1.43	16.44 1.53	17.49 1.62	18.54 1.72	19.59 1.82	20.64 1.92
	60 1.52	1.17 0.11	1.95 0.18	3.12 0.29	4.29 0.40	5.46 0.51	6.62 0.62	7.79 0.72	8.96 0.83	10.13 0.94	11.30 1.05	12.47 1.16	13.64 1.27	14.81 1.38	15.98 1.48	17.15 1.59	18.32 1.70	19.48 1.81	20.65 1.92	21.82 2.03	22.99 2.14
	66 1.68	1.32 0.12	2.20 0.20	3.52 0.33	4.84 0.45	6.15 0.57	7.47 0.69	8.79 0.82	10.11 0.94	11.43 1.06	12.75 1.18	14.07 1.31	15.39 1.43	16.71 1.55	18.02 1.67	19.34 1.80	20.66 1.92	21.98 2.04	23.30 2.16	24.62 2.29	25.94 2.41
	72 1.83	1.44 0.13	2.40 0.22	3.84 0.36	5.27 0.49	6.71 0.62	8.15 0.76	9.59 0.89	11.03 1.02	12.47 1.16	13.90 1.29	15.34 1.43	16.78 1.56	18.22 1.69	19.66 1.83	21.10 1.96	22.54 2.09	23.97 2.23	25.41 2.36	26.85 2.49	28.29 2.63
	78 1.98	1.65 0.15	2.76 0.26	4.41 0.41	6.06 0.56	7.71 0.72	9.37 0.87	11.02 1.02	12.67 1.18	14.33 1.33	15.98 1.48	17.63 1.64	19.29 1.79	20.94 1.95	22.59 2.10	24.25 2.25	25.90 2.41	27.55 2.56	29.20 2.71	30.86 2.87	32.51 3.02
	84 2.13	1.85 0.17	3.09 0.29	4.94 0.46	6.80 0.63	8.65 0.80	10.51 0.98	12.36 1.15	14.22 1.32	16.07 1.49	17.92 1.67	19.78 1.84	21.63 2.01	23.49 2.18	25.34 2.35	27.20 2.53	29.05 2.70	30.90 2.87	32.76 3.04	34.61 3.22	36.47 3.39
	90 2.29	1.83 0.17	3.05 0.28	4.88 0.45	6.71 0.62	8.54 0.79	10.37 0.96	12.20 1.13	14.04 1.30	15.87 1.47	17.70 1.64	19.53 1.81	21.36 1.98	23.19 2.15	25.02 2.32						
	96 2.44	1.95 0.18	3.25 0.30	5.19 0.48	7.14 0.66	9.09 0.84	11.04 1.03	12.99 1.21	14.93 1.39	16.88 1.57	18.83 1.75	20.78 1.93	22.72 2.11	24.67 2.29	26.62 2.47						
102 2.59	2.10 0.19	3.50 0.32	5.59 0.52	7.69 0.71	9.79 0.91	11.89 1.10	13.98 1.30	16.08 1.49	18.18 1.69	20.28 1.88	22.37 2.08	24.47 2.27	26.57 2.47	28.67 2.66							
108 2.74	2.22 0.21	3.70 0.34	5.91 0.55	8.13 0.76	10.35 0.96	12.57 1.17	14.79 1.37	17.00 1.58	19.22 1.79	21.44 1.99	23.66 2.20	25.87 2.40	28.09 2.61	30.31 2.82							
114 2.90	2.34 0.22	3.90 0.36	6.23 0.58	8.57 0.80	10.91 1.01	13.25 1.23	15.59 1.45	17.93 1.67	20.26 1.88	22.60 2.10	24.94 2.32	27.28 2.53	29.62 2.75	31.95 2.97							
120 3.05	2.49 0.23	4.14 0.39	6.63 0.62	9.12 0.85	11.61 1.08	14.09 1.31	16.58 1.54	19.07 1.77	21.55 2.00	24.04 2.23	26.53 2.46	29.01 2.70	31.50 2.93	33.99 3.16							



<b>SCHEDULE TYPE:</b>	Page 2 of 3			
<b>PROJECT:</b>	Dimensions are in inches (mm).			
<b>ENGINEER:</b>	<b>DATE</b>	<b>B SERIES</b>	<b>SUPERSEDES</b>	<b>DRAWING NO.</b>
<b>CONTRACTOR:</b>	3 - 12 - 24	1600	8 - 23 - 23	1602D



**EXTRUDED ALUMINUM STATIONARY LOUVER  
2" (51) DEEP • DRAINABLE BLADE  
PERFORMANCE DATA  
MODEL: 1602D**

**AIRFLOW/ WATER PENETRATION DATA  
for 48" x 48" (1219 x 1219) Louver Size**

	Free Area %	43%
	Free Area sq. ft. (sq. m.)	6.91 (0.64)
I N T A K E	Free Area Velocity at Beginning Point of Water Penetration at .01 oz./sq. ft. (3 ml/sq. m) (15 min. test duration)	910 fpm (277 m/min.)
	Air Volume at 910 fpm Free Area Velocity	6288 cfm (2968 l/s)
	Pressure Drop @ 910 fpm	.12 in. w.g. (30 Pa)

**NOTE:** To minimize water penetration when sizing intake louvers, select a Free Area Velocity that is **below** the beginning point of water penetration.

**PRESSURE DROP**

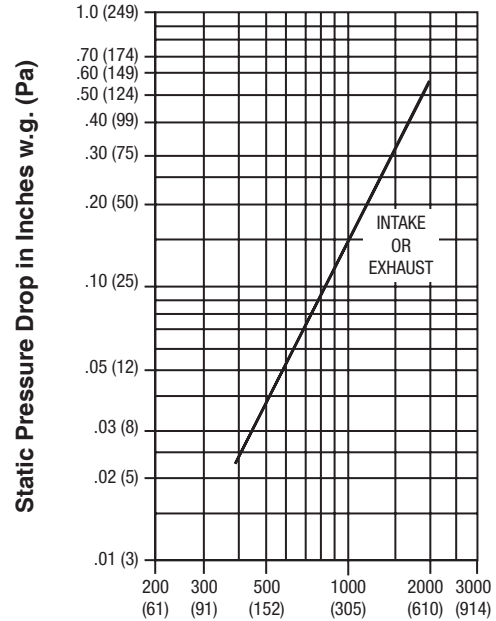

**Air Velocity in Feet (Meters) Per Minute Through Free Area**  
Louver test size: 48" x 48" (1219 x 1219 mm).  
Standard air density @ 0.075 lbs/ft<sup>3</sup>.  
Tested to AMCA Fig. 5.5 - 6.5.



Nailor Industries Inc. certifies that the Model 1602D shown herein is licensed to bear the AMCA Certified Ratings Program seal. The ratings shown are based on tests and procedures performed in accordance with AMCA Publication 511 and comply with the requirements of the AMCA Certified Ratings Program. The AMCA Certified Ratings Program seal applies to Water Penetration and Air Performance ratings.  
Louvers were tested in accordance with AMCA Standard 500-L.



<b>SCHEDULE TYPE:</b>	Page 3 of 3			
<b>PROJECT:</b>	Dimensions are in inches (mm).			
<b>ENGINEER:</b>	<b>DATE</b>	<b>B SERIES</b>	<b>SUPERSEDES</b>	<b>DRAWING NO.</b>
<b>CONTRACTOR:</b>	3 - 12 - 24	1600	8 - 23 - 23	1602D



**EXTRUDED ALUMINUM STATIONARY LOUVER**  
**4" (102) DEEP • DRAINABLE BLADE**  
**MODEL: 1604D**

Model 1604D, Drainable blade type louver, provides excellent weather protection in a 4" (102) deep frame, with good air performance and pleasing aesthetics that compliment any structure's exterior styling. Suitable for use in exhaust and low to medium velocity intake applications, the drainable blade design utilizes rain gutters that divert collected water down concealed side downspouts and out the sill. Blades are reinforced with full length integral bosses for superior strength and the design provides good air performance through it's large free area as well as maximum protection against the elements. Model 1604D is available with channel or flanged type frame to suit most architectural and mechanical installation requirements and is AMCA Licensed.

**STANDARD CONSTRUCTION:**

- FRAME:** 4" (102) deep, Type 6063-T6 extruded aluminum, .080" (2.03) nominal wall thickness. Integral downspouts and caulking slot provided.
- BLADES:** Type 6063-T6 extruded aluminum, .080" (2.03) nominal wall thickness, with reinforcing bosses.
- BLADE ANGLE:** Fixed at 37 degrees.
- BLADE SPACING:** Approx. 4" (102) on centers.
- BLADE SUPPORT BRACKETS:** Concealed type, factory installed on rear of louver on maximum 60" (1524) centers. Reinforced with 1 1/2" x 2" (38 x 51) angle (adds approx. 2" [51] to overall louver depth).
- MULLIONS:** Concealed type allowing continuous line appearance up to 120" (3048) wide. Larger assemblies require separate visible frames with downspouts.
- SCREEN:** 3/4" x .051 (19 x 1.3) expanded, flattened aluminum bird screen in removable frame, inside (rear) mount (adds approximately 3/8" [10] to louver depth).
- FINISH:** Mill.
- MINIMUM SIZE:** 12" W x 12" H (305 x 305).
- MAXIMUM SINGLE SECTION SIZE:** 120" W x 84" H (3048 x 2134) or 84" W x 120" H (2134 x 3048). 70 sq. ft. (6.5m<sup>2</sup>). Larger louvers will require field assembly of smaller sections.

**OPTIONS:**

- FL15** Flanged Frame, 1 1/2" (38).
- FL20** Flanged Frame, 2" (51).
- BSSS** Type 304 S.S. Bird Screen.
- BSN** No Bird Screen.
- ISA** Aluminum Insect Screen.
- ISSS** Type 304 S.S. Insect Screen.
- WE** Welded Construction.
- ESI** Extended Sill.
- FR1** 1" (25) Filter Rack.
- FR2** 2" (51) Filter Rack.
- PACA** Perimeter Anchor Clips.
- Other:** \_\_\_\_\_ .

**OPTIONAL FINISHES:**

- PC3** Powder Coat AAMA 2603. Color: \_\_\_\_\_ .
- PC4** High Performance Powder Coat AAMA 2604 (Equivalent to 50% Kynar®). Color: \_\_\_\_\_ .
- PC5** Fluoropolymer Powder Coat AAMA 2605 (Equivalent to 70% Kynar®). Color: \_\_\_\_\_ .
- PCC** Prime Coat.
- AN04** Clear Anodized 204-R1.
- AN15** Clear Anodized 215-R1.

Color Anodized:

- ANLB** Light Bronze.       **ANMB** Medium Bronze.
- ANDB** Dark Bronze.       **ANBK** Black.

**OPTIONAL W x H SIZING** (1/4" [6.5] Undersize standard):

- U00** Exact Size.
- U38** Undersize 3/8" (9.5).
- U50** Undersize 1/2" (12.7).

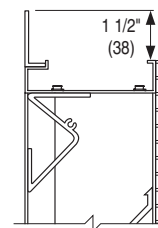
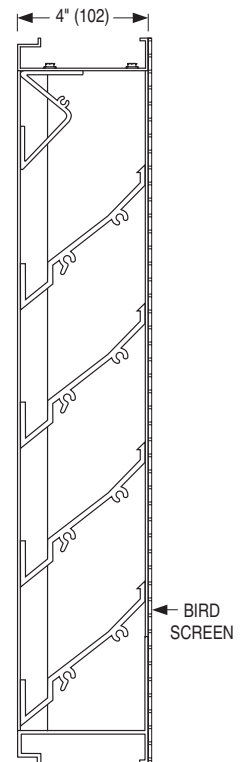
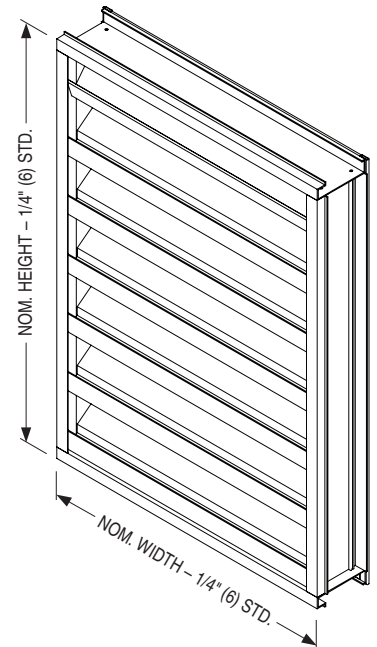

OPT. FLANGED FRAME (FL15 STD.)

<b>SCHEDULE TYPE:</b>
<b>PROJECT:</b>
<b>ENGINEER:</b>
<b>CONTRACTOR:</b>

Page 1 of 3  
 Dimensions are in inches (mm).

DATE	B SERIES	SUPERSEDES	DRAWING NO.
3 - 12 - 24	1600	2 - 17 - 22	1604D



**EXTRUDED ALUMINUM STATIONARY LOUVER  
4" (102) DEEP • DRAINABLE BLADE  
PERFORMANCE DATA  
MODEL: 1604D**

**FREE AREA in Square Feet and Square Meters**

		Width in Inches and Meters																		
		12	18	24	30	36	42	48	54	60	66	72	78	84	90	96	102	108	114	120
Height in Inches and Meters	12	0.31	0.50	0.68	0.87	1.06	1.24	1.43	1.62	1.80	1.99	2.18	2.36	2.55	2.74	2.92	3.11	3.30	3.48	3.67
	0.30	0.03	0.05	0.06	0.08	0.10	0.12	0.13	0.15	0.17	0.18	0.20	0.22	0.24	0.25	0.27	0.29	0.31	0.32	0.34
	18	0.54	0.87	1.20	1.52	1.85	2.18	2.50	2.83	3.16	3.48	3.81	4.14	4.47	4.79	5.12	5.45	5.77	6.10	6.43
	0.46	0.05	0.08	0.11	0.14	0.17	0.20	0.23	0.26	0.29	0.32	0.35	0.38	0.41	0.45	0.48	0.51	0.54	0.57	0.60
	24	0.78	1.24	1.71	2.18	2.64	3.11	3.58	4.04	4.51	4.98	5.44	5.91	6.38	6.85	7.31	7.78	8.25	8.71	9.18
	0.61	0.07	0.12	0.16	0.20	0.25	0.29	0.33	0.38	0.42	0.46	0.51	0.55	0.59	0.64	0.68	0.72	0.77	0.81	0.85
	30	1.06	1.69	2.33	2.97	3.60	4.24	4.87	5.51	6.14	6.78	7.41	8.05	8.69	9.32	9.96	10.59	11.23	11.86	12.50
	0.76	0.10	0.16	0.22	0.28	0.33	0.39	0.45	0.51	0.57	0.63	0.69	0.75	0.81	0.87	0.92	0.98	1.04	1.10	1.16
	36	1.29	2.07	2.84	3.62	4.39	5.17	5.95	6.72	7.50	8.27	9.05	9.82	10.60	11.37	12.15	12.93	13.70	14.48	15.25
	0.91	0.12	0.19	0.26	0.34	0.41	0.48	0.55	0.62	0.70	0.77	0.84	0.91	0.98	1.06	1.13	1.20	1.27	1.34	1.42
	42	1.57	2.52	3.46	4.41	5.35	6.30	7.24	8.18	9.13	10.07	11.02	11.96	12.91	13.85	14.79	15.74	16.68	17.63	18.57
	1.07	0.15	0.23	0.32	0.41	0.50	0.58	0.67	0.76	0.85	0.94	1.02	1.11	1.20	1.29	1.37	1.46	1.55	1.64	1.73
	48	1.81	2.89	3.98	5.06	6.14	7.23	8.26	9.40	10.48	11.57	12.65	13.74	14.82	15.90	16.99	18.07	19.16	20.24	21.33
	1.22	0.17	0.27	0.37	0.47	0.57	0.67	0.77	0.87	0.97	1.07	1.18	1.28	1.38	1.48	1.58	1.68	1.78	1.88	1.98
	54	2.04	3.27	4.49	5.71	6.94	8.16	9.39	10.61	11.84	13.06	14.28	15.51	16.73	17.96	19.18	20.41	21.63	22.86	24.08
	1.37	0.19	0.30	0.42	0.53	0.64	0.76	0.87	0.99	1.10	1.21	1.33	1.44	1.55	1.67	1.78	1.90	2.01	2.12	2.24
60	2.32	3.72	5.11	6.50	7.89	9.29	10.68	12.07	13.47	14.86	16.25	17.65	19.04	20.43	21.83	23.22	24.61	26.01	27.40	
1.52	0.22	0.35	0.47	0.60	0.73	0.86	0.99	1.12	1.25	1.38	1.51	1.64	1.77	1.90	2.03	2.16	2.29	2.42	2.55	
66	2.56	4.09	5.62	7.15	8.69	10.22	11.75	13.29	14.82	16.35	17.89	19.42	20.95	22.49	24.02	25.55	27.09	28.62	30.15	
1.68	0.24	0.38	0.52	0.66	0.81	0.95	1.09	1.23	1.38	1.52	1.66	1.80	1.95	2.09	2.23	2.37	2.52	2.66	2.80	
72	2.84	4.54	6.24	7.94	9.64	11.35	13.05	14.75	16.45	18.15	19.86	21.56	23.26	24.96	26.66	28.37	30.07	31.77	33.47	
1.83	0.26	0.42	0.58	0.74	0.90	1.05	1.21	1.37	1.53	1.69	1.84	2.00	2.16	2.32	2.48	2.64	2.79	2.95	3.11	
78	3.07	4.91	6.75	8.60	10.44	12.28	14.12	15.96	17.81	19.65	21.49	23.33	25.17	27.02	28.86	30.70	32.54	34.38	36.23	
1.98	0.29	0.46	0.63	0.80	0.97	1.14	1.31	1.48	1.65	1.83	2.00	2.17	2.34	2.51	2.68	2.85	3.02	3.19	3.37	
84	3.30	5.29	7.27	9.25	11.23	13.21	15.20	17.18	19.16	21.14	23.12	25.11	27.09	29.07	31.05	33.03	35.02	37.00	38.98	
2.13	0.31	0.49	0.68	0.86	1.04	1.23	1.41	1.60	1.78	1.96	2.15	2.33	2.52	2.70	2.88	3.07	3.25	3.44	3.62	
90	3.58	5.74	7.89	10.04	12.19	14.34	16.49	18.64	20.79	22.94	25.09	27.24	29.39							
2.29	0.33	0.53	0.73	0.93	1.13	1.33	1.53	1.73	1.93	2.13	2.33	2.53	2.73							
96	3.82	6.11	8.40	10.69	12.98	15.27	17.56	19.85	22.15	24.44	26.73	29.02	31.31							
2.44	0.35	0.57	0.78	0.99	1.21	1.42	1.63	1.84	2.06	2.27	2.48	2.70	2.91							
102	4.10	6.56	9.02	11.48	13.94	16.40	18.86	21.32	23.78	26.24	28.70	31.16	33.62							
2.59	0.38	0.61	0.84	1.07	1.29	1.52	1.75	1.98	2.21	2.44	2.67	2.89	3.12							
108	4.33	6.93	9.53	12.13	14.73	17.33	19.93	22.53	25.13	27.73	30.33	32.93	35.53							
2.74	0.40	0.64	0.89	1.13	1.37	1.61	1.85	2.09	2.33	2.58	2.82	3.06	3.30							
114	4.57	7.31	10.05	12.79	15.53	18.26	21.00	23.74	26.48	29.22	31.96	34.70	37.44							
2.90	0.42	0.68	0.93	1.19	1.44	1.70	1.95	2.21	2.46	2.71	2.97	3.22	3.48							
120	4.85	7.76	10.66	13.57	16.48	19.39	22.30	25.21	28.12	31.02	33.93	36.84	39.75							
3.05	0.45	0.72	0.99	1.26	1.53	1.80	2.07	2.34	2.61	2.88	3.15	3.42	3.69							



<b>SCHEDULE TYPE:</b>	Page 2 of 3			
<b>PROJECT:</b>	Dimensions are in inches (mm).			
<b>ENGINEER:</b>	<b>DATE</b>	<b>B SERIES</b>	<b>SUPERSEDES</b>	<b>DRAWING NO.</b>
<b>CONTRACTOR:</b>	3 - 12 - 24	1600	2 - 17 - 22	1604D



**EXTRUDED ALUMINUM STATIONARY LOUVER  
4" (102) DEEP • DRAINABLE BLADE  
PERFORMANCE DATA  
MODEL: 1604D**

**AIRFLOW/WATER PENETRATION DATA  
for 48" x 48" (1219 x 1219) Louver Size**

I N T A K E	Free Area %	52%
	Free Area sq. ft. (sq. m.)	8.26 (0.77)
	Free Area Velocity at Point of Beginning Water Penetration at .01 oz./sq. ft. (3 ml/sq. m) (15 min. test duration)	906 fpm (276 m/min.)
	Air Volume at 906 fpm	7484 cfm (3532 l/s)
	Pressure Drop @ 906 fpm	.15 in. w.g. (37 Pa)

**NOTE:** To minimize water penetration when sizing intake louvers, select a Free Area Velocity that is **below** the point of beginning water penetration.

**PRESSURE DROP**

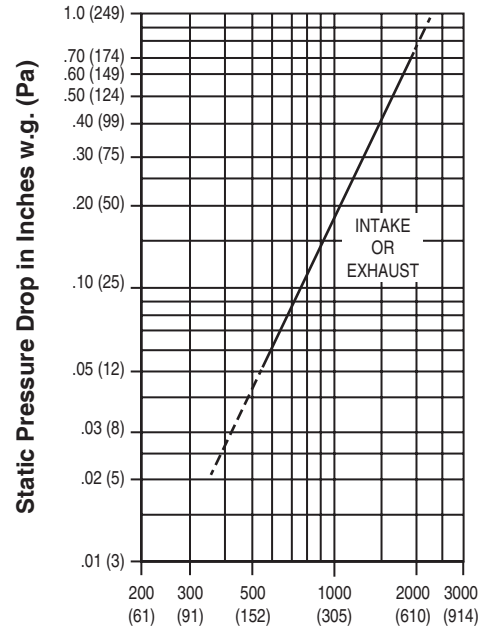

**Air Velocity in Feet (Meters) Per Minute Through Free Area**  
Louver test size: 48" x 48" (1219 x 1219 mm).  
Standard air density @ 0.075 lbs/ft<sup>3</sup>.  
Tested to AMCA Fig. 5.5 – 6.5.



Nailor Industries Inc. certifies that the Model 1604D shown herein is licensed to bear the AMCA Certified Ratings Program seal. The ratings shown are based on tests and procedures performed in accordance with AMCA Publication 511 and comply with the requirements of the AMCA Certified Ratings Program. The AMCA Certified Ratings Program seal applies to Water Penetration and Air Performance ratings.

Louvers were tested in accordance with AMCA Standard 500-L.



<b>SCHEDULE TYPE:</b>	Page 3 of 3			
<b>PROJECT:</b>	Dimensions are in inches (mm).			
<b>ENGINEER:</b>	<b>DATE</b>	<b>B SERIES</b>	<b>SUPERSEDES</b>	<b>DRAWING NO.</b>
<b>CONTRACTOR:</b>	3 - 12 - 24	1600	2 - 17 - 22	1604D





**EXTRUDED ALUMINUM STATIONARY LOUVER**  
**4" (102) DEEP • DUAL DRAINABLE BLADE**  
**MODEL: 1604DD**

Model 1604DD, dual drainable blade type louver, provides maximum weather protection in a 4" (102) deep frame, with good air performance and pleasing aesthetics that compliment any structure's exterior styling. Standard construction features a drainable head that collects the water running down the building face and channels it out the concealed downspouts in the side frame, preventing it from flowing down into the airstream. Suitable for use in exhaust and low to medium velocity intake applications, the dual drainable blade design utilizes double rain gutters that divert collected water down concealed side downspouts and out the sill. Blades are reinforced with full length integral bosses for superior strength and the design provides good air performance through it's 51% free area as well as maximum protection against the elements. Model 1604DD is available with channel or flanged type frame to suit most architectural and mechanical installation requirements and is AMCA Licensed.

**STANDARD CONSTRUCTION:**

- FRAME:** 4" (102) deep, Type 6063-T6 extruded aluminum, .080" (2.03) nominal wall thickness. Integral downspouts and caulking slot provided.
- BLADES:** Type 6063-T6 extruded aluminum, .080" (2.03) nominal wall thickness, with reinforcing bosses.
- BLADE ANGLE:** Fixed at 37 degrees.
- BLADE SPACING:** Approx. 4" (102) on centers.
- BLADE SUPPORT BRACKETS:** Concealed type, factory installed on rear of louver on maximum 60" (1524) centers. Reinforced with 1 1/2" x 2" (38 x 51) angle (adds approx. 2" [51] to overall louver depth).
- MULLIONS:** Concealed type allowing continuous line appearance up to 120" (3048) wide. Larger assemblies require separate visible frames with downspouts.
- SCREEN:** 3/4" x .051 (19 x 1.3) expanded, flattened aluminum bird screen in removable frame, inside (rear) mount (adds approximately 3/8" [10] to louver depth).
- FINISH:** Mill.
- MINIMUM SIZE:** 12" W x 12" H (305 x 305).
- MAX. SINGLE SECTION SIZE:** 120" W x 84" H (3048 x 2134) or 84" W x 120" H (2134 x 3048). 70 sq. ft. (6.5m<sup>2</sup>). Larger louvers will require field assembly of smaller sections.

**OPTIONS:**

- FL15** Flanged Frame, 1 1/2" (38).
- FL20** Flanged Frame, 2" (51).
- BSSS** Type 304 S.S. Bird Screen.
- BSN** No Bird Screen.
- ISA** Aluminum Insect Screen.
- ISSS** Type 304 S.S. Insect Screen.
- WE** Welded Construction.
- ESI** Extended Sill.
- FR1** 1" (25) Filter Rack.
- FR2** 2" (51) Filter Rack.
- PACA** Perimeter Anchor Clips.
- Other:** \_\_\_\_\_ .

**OPTIONAL FINISHES:**

- PC3** Powder Coat AAMA 2603. Color: \_\_\_\_\_ .
  - PC4** High Performance Powder Coat AAMA 2604 (Equiv. to 50% Kynar®). Color: \_\_\_\_\_ .
  - PC5** Fluoropolymer Powder Coat AAMA 2605 (Equiv. to 70% Kynar®). Color: \_\_\_\_\_ .
  - PCC** Prime Coat.
  - AN04** Clear Anodized 204-R1.
  - AN15** Clear Anodized 215-R1.
- Color Anodized:
- ANLB** Light Bronze.       **ANMB** Medium Bronze.
  - ANDB** Dark Bronze.       **ANBK** Black.

**OPTIONAL W x H SIZING** (1/4" [6.5] Undersize standard):

- U00** Exact Size.
- U38** Undersize 3/8" (9.5).
- U50** Undersize 1/2" (12.7).

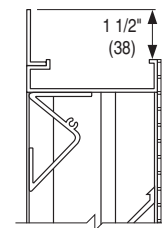
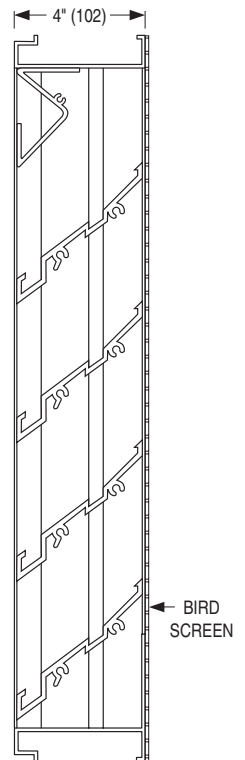
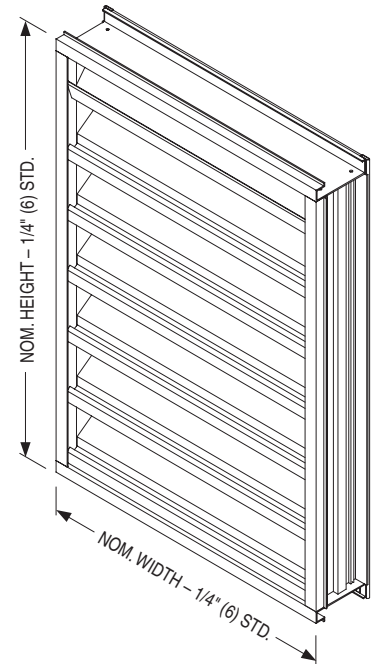

OPT. FLANGED FRAME (FL15 STD.)

<b>SCHEDULE TYPE:</b>
<b>PROJECT:</b>
<b>ENGINEER:</b>
<b>CONTRACTOR:</b>

Page 1 of 3  
Dimensions are in inches (mm).

DATE	B SERIES	SUPERSEDES	DRAWING NO.
3 - 12 - 24	1600	2 - 17 - 22	1604DD



**EXTRUDED ALUMINUM STATIONARY LOUVER  
4" (102) DEEP • DUAL DRAINABLE BLADE  
PERFORMANCE DATA  
MODEL: 1604DD**

**FREE AREA in Square Feet and Square Meters**

		Width in Inches and Meters																		
		12 0.30	18 0.46	24 0.61	30 0.76	36 0.91	42 1.07	48 1.22	54 1.37	60 1.52	66 1.68	72 1.83	78 1.98	84 2.13	90 2.29	96 2.44	102 2.59	108 2.74	114 2.90	120 3.05
Height in Inches and Meters	12 0.30	0.23 0.02	0.37 0.03	0.51 0.05	0.65 0.06	0.79 0.07	0.93 0.09	1.07 0.10	1.21 0.11	1.35 0.13	1.49 0.14	1.63 0.15	1.77 0.16	1.91 0.18	2.05 0.19	2.19 0.20	2.33 0.22	2.47 0.23	2.61 0.24	2.75 0.26
	18 0.46	0.54 0.05	0.86 0.08	1.18 0.11	1.51 0.14	1.83 0.17	2.15 0.20	2.47 0.23	2.80 0.26	3.12 0.29	3.44 0.32	3.77 0.35	4.09 0.38	4.41 0.41	4.73 0.44	5.06 0.47	5.38 0.50	5.70 0.53	6.02 0.56	6.35 0.59
	24 0.61	0.73 0.07	1.17 0.11	1.61 0.15	2.05 0.19	2.49 0.23	2.93 0.27	3.37 0.31	3.81 0.35	4.25 0.40	4.69 0.44	5.13 0.48	5.57 0.52	6.01 0.56	6.45 0.60	6.89 0.64	7.33 0.68	7.77 0.72	8.21 0.76	8.65 0.80
	30 0.76	1.01 0.09	1.62 0.15	2.23 0.21	2.83 0.26	3.44 0.32	4.05 0.38	4.65 0.43	5.26 0.49	5.87 0.55	6.47 0.60	7.08 0.66	7.69 0.71	8.30 0.77	8.90 0.83	9.51 0.88	10.12 0.94	10.72 1.00	11.33 1.05	11.94 1.11
	36 0.91	1.29 0.12	2.06 0.19	2.84 0.26	3.61 0.34	4.39 0.41	5.16 0.48	5.93 0.55	6.71 0.62	7.48 0.70	8.26 0.77	9.03 0.84	9.80 0.91	10.58 0.98	11.35 1.05	12.13 1.13	12.90 1.20	13.67 1.27	14.45 1.34	15.22 1.41
	42 1.07	1.51 0.14	2.42 0.23	3.33 0.31	4.24 0.39	5.15 0.48	6.06 0.56	6.96 0.65	7.87 0.73	8.78 0.82	9.69 0.90	10.60 0.98	11.51 1.07	12.41 1.15	13.32 1.24	14.23 1.32	15.14 1.41	16.05 1.49	16.95 1.58	17.86 1.66
	48 1.22	1.79 0.17	2.87 0.27	3.94 0.37	5.02 0.47	6.09 0.57	7.17 0.67	8.14 0.76	9.32 0.87	10.39 0.97	11.47 1.07	12.54 1.17	13.62 1.27	14.69 1.37	15.77 1.46	16.84 1.56	17.92 1.66	18.99 1.76	20.07 1.86	21.14 1.96
	54 1.37	2.07 0.19	3.31 0.31	4.55 0.42	5.80 0.54	7.04 0.65	8.28 0.77	9.52 0.88	10.76 1.00	12.00 1.12	13.25 1.23	14.49 1.35	15.73 1.46	16.97 1.58	18.21 1.69	19.46 1.81	20.70 1.92	21.94 2.04	23.18 2.15	24.42 2.27
	60 1.52	2.29 0.21	3.67 0.34	5.05 0.47	6.42 0.60	7.80 0.72	9.18 0.85	10.55 0.98	11.93 1.11	13.30 1.24	14.68 1.36	16.06 1.49	17.43 1.62	18.81 1.75	20.19 1.88	21.56 2.00	22.94 2.13	24.32 2.26	25.69 2.39	27.07 2.51
	66 1.68	2.58 0.24	4.13 0.38	5.68 0.53	7.23 0.67	8.78 0.82	10.32 0.96	11.87 1.10	13.42 1.25	14.97 1.39	16.52 1.53	18.07 1.68	19.61 1.82	21.16 1.97	22.71 2.11	24.26 2.25	25.81 2.40	27.36 2.54	28.91 2.69	30.45 2.83
	72 1.83	2.80 0.26	4.47 0.42	6.15 0.57	7.83 0.73	9.50 0.88	11.18 1.04	12.86 1.19	14.54 1.35	16.21 1.51	17.89 1.66	19.57 1.82	21.25 1.97	22.92 2.13	24.60 2.29	26.28 2.44	27.96 2.60	29.63 2.75	31.31 2.91	32.99 3.06
	78 1.98	3.07 0.29	4.92 0.46	6.76 0.63	8.61 0.80	10.45 0.97	12.30 1.14	14.14 1.31	15.99 1.49	17.83 1.66	19.67 1.83	21.52 2.00	23.36 2.17	25.21 2.34	27.05 2.51	28.90 2.68	30.74 2.86	32.59 3.03	34.43 3.20	36.28 3.37
	84 2.13	3.35 0.31	5.36 0.50	7.38 0.69	9.39 0.87	11.40 1.06	13.41 1.25	15.42 1.43	17.43 1.62	19.44 1.81	21.45 1.99	23.47 2.18	25.48 2.37	27.49 2.55	29.50 2.74	31.51 2.93	33.52 3.11	35.53 3.30	37.55 3.49	39.56 3.67
	90 2.29	3.58 0.33	5.72 0.53	7.87 0.73	10.01 0.93	12.16 1.13	14.30 1.33	16.45 1.53	18.59 1.73	20.74 1.93	22.88 2.13	25.03 2.33	27.17 2.52	29.32 2.72						
	96 2.44	3.85 0.36	6.17 0.57	8.48 0.79	10.79 1.00	13.10 1.22	15.42 1.43	17.73 1.65	20.04 1.86	22.35 2.08	24.67 2.29	26.98 2.51	29.29 2.72	31.60 2.94						
	102 2.59	4.14 0.38	6.62 0.61	9.10 0.85	11.58 1.08	14.06 1.31	16.55 1.54	19.03 1.77	21.51 2.00	23.99 2.23	26.47 2.46	28.95 2.69	31.44 2.92	33.92 3.15						
108 2.74	4.36 0.40	6.97 0.65	9.58 0.89	12.20 1.13	14.81 1.38	17.42 1.62	20.04 1.86	22.65 2.10	25.27 2.35	27.88 2.59	30.49 2.83	33.11 3.08	35.72 3.32							
114 2.90	4.63 0.43	7.42 0.69	10.20 0.95	12.98 1.21	15.76 1.46	18.54 1.72	21.32 1.98	24.10 2.24	26.88 2.50	29.66 2.76	32.44 3.01	35.22 3.27	38.00 3.53							
120 3.05	4.86 0.45	7.77 0.72	10.69 0.99	13.60 1.26	16.51 1.53	19.43 1.80	22.34 2.08	25.26 2.35	28.17 2.62	31.09 2.89	34.00 3.16	36.91 3.43	39.83 3.70							



<b>SCHEDULE TYPE:</b>	Page 2 of 3			
<b>PROJECT:</b>	Dimensions are in inches (mm).			
<b>ENGINEER:</b>	<b>DATE</b>	<b>B SERIES</b>	<b>SUPERSEDES</b>	<b>DRAWING NO.</b>
<b>CONTRACTOR:</b>	3 - 12 - 24	1600	2 - 17 - 22	1604DD





**EXTRUDED ALUMINUM STATIONARY LOUVER  
4" (102) DEEP • DUAL DRAINABLE BLADE  
PERFORMANCE DATA  
MODEL: 1604DD**

**AIRFLOW/WATER PENETRATION DATA  
for 48" x 48" (1219 x 1219) Louver Size**

Free Area %	51%	
Free Area sq. ft. (sq. m.)	8.14 (0.76)	
I N T A K E	Free Area Velocity at Point of Beginning Water Penetration at .01 oz./sq. ft. (3 ml/sq. m) (15 min. test duration)	1000 fpm (305 m/min.)
	Air Volume at 1000 fpm	8140 cfm (3841 l/s)
	Free Area Velocity	
	Pressure Drop @ 1000 fpm	.16 in. w.g. (40 Pa)

**NOTE:** To minimize water penetration when sizing intake louvers, select a Free Area Velocity that is **below** the point of beginning water penetration.

**PRESSURE DROP**

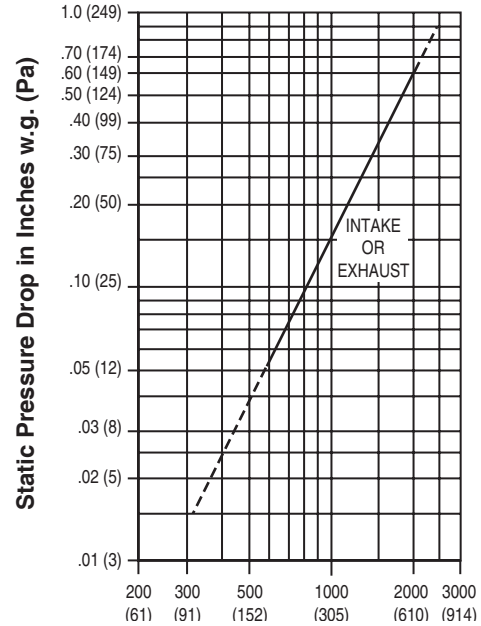

**Air Velocity in Feet (Meters) Per Minute Through Free Area**  
Louver test size: 48" x 48" (1219 x 1219 mm).  
Standard air density @ 0.075 lbs/ft<sup>3</sup>.  
Tested to AMCA Fig. 5.5 – 6.5.



Nailor Industries Inc. certifies that the Model 1604DD shown herein is licensed to bear the AMCA Certified Ratings Program seal. The ratings shown are based on tests and procedures performed in accordance with AMCA Publication 511 and comply with the requirements of the AMCA Certified Ratings Program. The AMCA Certified Ratings Program seal applies to Water Penetration and Air Performance ratings.

Louvers were tested in accordance with AMCA Standard 500-L.



<b>SCHEDULE TYPE:</b>	Page 3 of 3			
<b>PROJECT:</b>	Dimensions are in inches (mm).			
<b>ENGINEER:</b>	<b>DATE</b>	<b>B SERIES</b>	<b>SUPERSEDES</b>	<b>DRAWING NO.</b>
<b>CONTRACTOR:</b>	3 - 7 - 24	1600	2 - 17 - 22	1604DD



**EXTRUDED ALUMINUM STATIONARY LOUVER**  
**4" (102) DEEP • HIGH PERFORMANCE**  
**DRAINABLE BLADE**  
**MODEL: 1604DHP**

Model 1604DHP High Performance Drainable Blade Louvers provide air intake and exhaust opening protection with pleasing aesthetics that compliment any structure's exterior styling. Suitable for use in exhaust and high velocity intake applications, the design provides superior air performance through its high free area. Front rain gutters in each blade divert collected water down concealed side downspouts and out the sill. Blades are reinforced with full length integral bosses for superior strength and the 4" (102) deep channel or optional flanged and glazing adaptor frame installs easily in common wall configurations to suit most architectural and mechanical installation requirements. AMCA Licensed and Certified for Air Performance and Water Penetration.

**STANDARD CONSTRUCTION:**

- FRAME:** 4" (102) deep, Type 6063-T6 extruded aluminum, .080" (2.03) nominal wall thickness. Integral downspouts and caulking slot provided.
- BLADES:** Type 6063-T6 extruded aluminum, .080" (2.03) nominal wall thickness, with reinforcing bosses.
- BLADE ANGLE:** Fixed at 31.5 degrees.
- BLADE SPACING:** Approximately 3" (76) on centers.
- BLADE SUPPORT BRACKETS:** Concealed type, factory installed on rear of louver on maximum 60" (1524) centers. Reinforced with 1 1/2" x 2" (38 x 51) angle (adds approx. 2" [51] to overall louver depth).
- MULLIONS:** Concealed type allowing continuous line appearance up to 120" (3048) wide. Larger assemblies require separate visible frames with downspouts.
- SCREEN:** 3/4" x .051 (19 x 1.3) expanded, flattened aluminum bird screen in removable frame, inside (rear) mount (adds approximately 3/8" [10] to louver depth).
- FINISH:** Mill.
- MINIMUM SIZE:** 12" W x 9" H (305 x 229).
- MAX. SINGLE SECTION SIZE:** 120" W x 84" H (3048 x 2134) or 84" W x 120" H (2134 x 3048). 70 sq. ft. (6.5m<sup>2</sup>). Larger louvers will require field assembly of smaller sections.

**OPTIONS:**

- FL15** Flanged Frame, 1 1/2" (38).
- FL20** Flanged Frame, 2" (51).
- BSSS** Type 304 S.S. Bird Screen.
- BSN** No Bird Screen.
- ISA** Aluminum Insect Screen.
- ISSS** Type 304 S.S. Insect Screen.
- WE** Welded Construction.
- ESI** Extended Sill.
- FR1** 1" (25) Filter Rack.
- FR2** 2" (51) Filter Rack.
- PACA** Perimeter Anchor Clips.
- Other:** \_\_\_\_\_

**OPTIONAL FINISHES:**

- PC3** Powder Coat AAMA 2603. Color: \_\_\_\_\_ .
- PC4** High Performance Powder Coat AAMA 2604 (Equivalent to 50% Kynar®). Color: \_\_\_\_\_ .
- PC5** Fluoropolymer Powder Coat AAMA 2605 (Equivalent to 70% Kynar®). Color: \_\_\_\_\_ .
- PCC** Prime Coat.
- AN04** Clear Anodized 204-R1.
- AN15** Clear Anodized 215-R1.

**Color Anodized:**

- ANLB** Light Bronze.       **ANMB** Medium Bronze.
- ANDB** Dark Bronze.       **ANBK** Black.

**OPTIONAL W x H SIZING** (1/4" [6.5] Undersize standard):

- U00** Exact Size.
- U38** Undersize 3/8" (9.5).
- U50** Undersize 1/2" (12.7).

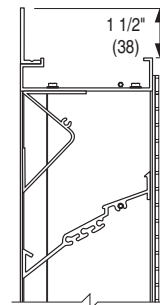
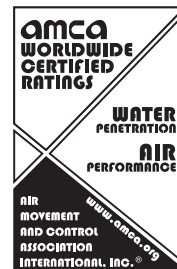
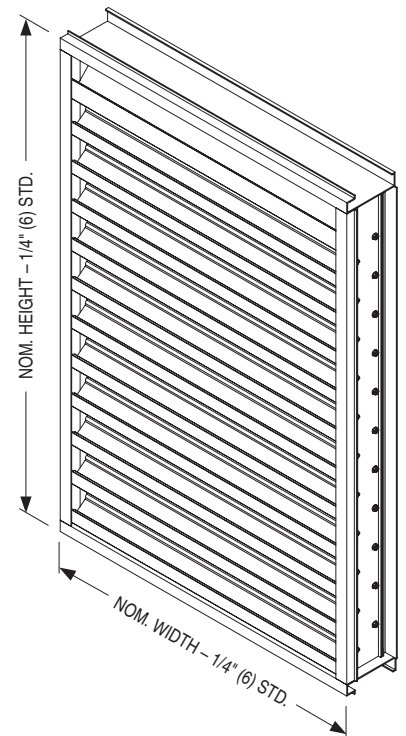

OPT. FLANGED FRAME (FL15 STD.)

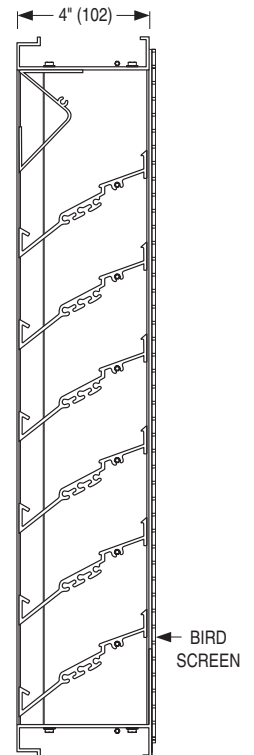

BIRD SCREEN

<b>SCHEDULE TYPE:</b>
<b>PROJECT:</b>
<b>ENGINEER:</b>
<b>CONTRACTOR:</b>

Page 1 of 3  
Dimensions are in inches (mm).

DATE	B SERIES	SUPERSEDES	DRAWING NO.
3 - 12 - 24	1600	1 - 27 - 23	1604DHP



**EXTRUDED ALUMINUM STATIONARY LOUVER  
4" (102) DEEP • HIGH PERFORMANCE  
DRAINABLE BLADE • PERFORMANCE DATA  
MODEL: 1604DHP**

**FREE AREA in Square Feet and Square Meters**

		Width in Inches and Meters																			
		12	18	24	30	36	42	48	54	60	66	72	78	84	90	96	102	108	114	120	
Height in Inches and Meters	12	0.30	0.46	0.61	0.76	0.91	1.07	1.22	1.37	1.52	1.68	1.83	1.98	2.13	2.29	2.44	2.59	2.74	2.90	3.05	
	0.30	0.32	0.52	0.71	0.91	1.11	1.31	1.51	1.71	1.86	2.06	2.26	2.46	2.65	2.85	3.05	3.25	3.45	3.65	3.85	
	0.03	0.03	0.05	0.07	0.08	0.10	0.12	0.14	0.16	0.17	0.19	0.21	0.23	0.25	0.27	0.28	0.30	0.32	0.34	0.36	
	18	0.46	0.59	0.96	1.33	1.70	2.06	2.43	2.80	3.17	3.45	3.82	4.19	4.56	4.93	5.30	5.67	6.03	6.40	6.77	7.14
	0.46	0.05	0.09	0.12	0.16	0.19	0.23	0.26	0.29	0.32	0.35	0.39	0.42	0.46	0.49	0.53	0.56	0.59	0.63	0.66	
	24	0.61	0.86	1.40	1.94	2.48	3.02	3.56	4.10	4.64	5.04	5.58	6.12	6.66	7.20	7.74	8.28	8.82	9.36	9.90	10.44
	0.61	0.08	0.13	0.18	0.23	0.28	0.33	0.38	0.43	0.47	0.52	0.57	0.62	0.67	0.72	0.77	0.82	0.87	0.92	0.97	
	30	0.76	1.13	1.84	2.55	3.26	3.97	4.68	5.39	6.10	6.57	7.28	7.99	8.70	9.41	10.12	10.83	11.54	12.25	12.96	13.67
	0.76	0.10	0.17	0.24	0.30	0.37	0.43	0.50	0.57	0.61	0.68	0.74	0.81	0.87	0.94	1.01	1.07	1.14	1.20	1.27	
	36	0.36	1.40	2.28	3.16	4.04	4.92	5.80	6.68	7.56	8.15	9.03	9.91	10.79	11.67	12.55	13.43	14.31	15.19	16.07	16.95
	0.36	0.13	0.21	0.29	0.38	0.46	0.54	0.62	0.70	0.76	0.84	0.92	1.00	1.08	1.17	1.25	1.33	1.41	1.49	1.57	
	42	1.07	1.67	2.72	3.77	4.82	5.87	6.93	7.98	9.03	9.81	10.87	11.92	12.97	14.02	15.07	16.12	17.17	18.22	19.27	20.32
	1.07	0.16	0.25	0.35	0.45	0.55	0.64	0.74	0.84	0.91	1.01	1.11	1.20	1.30	1.40	1.50	1.59	1.69	1.79	1.89	
	48	1.22	1.94	3.16	4.39	5.61	6.83	8.05	9.11	10.49	11.41	12.63	13.85	15.07	16.29	17.51	18.73	19.95	21.17	22.39	23.62
	1.22	0.18	0.29	0.41	0.52	0.63	0.75	0.85	0.97	1.06	1.17	1.29	1.40	1.51	1.63	1.74	1.85	1.97	2.08	2.19	
	54	1.37	2.21	3.61	5.00	6.39	7.78	9.17	10.56	11.95	13.00	14.39	15.78	17.17	18.56	19.95	21.34	22.74	24.13	25.52	26.91
	1.37	0.21	0.33	0.46	0.59	0.72	0.85	0.98	1.11	1.21	1.34	1.47	1.60	1.72	1.85	1.98	2.11	2.24	2.37	2.50	
	60	1.52	2.49	4.05	5.61	7.17	8.73	10.29	11.86	13.42	14.59	16.15	17.71	19.27	20.83	22.40	23.96	25.52	27.08	28.64	30.20
	1.52	0.23	0.38	0.52	0.67	0.81	0.96	1.10	1.25	1.36	1.50	1.65	1.79	1.94	2.08	2.23	2.37	2.52	2.66	2.81	
	66	1.68	2.76	4.49	6.22	7.95	9.68	11.42	13.15	14.88	16.18	17.91	19.64	21.38	23.11	24.84	26.57	28.30	30.04	31.77	33.50
1.68	0.26	0.42	0.58	0.74	0.90	1.06	1.22	1.38	1.50	1.66	1.82	1.99	2.15	2.31	2.47	2.63	2.79	2.95	3.11		
72	1.83	3.03	4.93	6.83	8.73	10.64	12.54	14.44	16.34	17.77	19.67	21.58	23.48	25.38	27.28	29.18	31.09	32.99	34.89	36.79	
1.83	0.28	0.46	0.63	0.81	0.99	1.16	1.34	1.52	1.65	1.83	2.00	2.18	2.36	2.53	2.71	2.89	3.06	3.24	3.42		
78	1.98	3.30	5.37	7.44	9.52	11.59	13.66	15.73	17.81	19.36	21.43	23.51	25.58	27.65	29.72	31.80	33.87	35.94	38.02	40.09	
1.98	0.31	0.50	0.69	0.88	1.08	1.27	1.46	1.65	1.80	1.99	2.18	2.38	2.57	2.76	2.95	3.15	3.34	3.53	3.72		
84	2.13	3.57	5.81	8.06	10.30	12.54	14.78	17.03	19.27	20.95	23.20	25.44	27.68	29.92	32.17	34.41	36.65	38.90	41.14	43.38	
2.13	0.33	0.54	0.75	0.96	1.17	1.37	1.58	1.79	1.95	2.15	2.36	2.57	2.78	2.99	3.20	3.41	3.61	3.82	4.03		
90	2.29	3.84	6.25	8.67	11.08	13.49	15.91	18.32	20.73	22.54	24.96	27.37	29.78	32.20							
2.29	0.36	0.58	0.81	1.03	1.25	1.48	1.70	1.93	2.09	2.32	2.54	2.77	2.99								
96	2.44	4.11	6.70	9.28	11.86	14.45	17.03	19.61	22.20	24.14	26.72	29.30	31.89	34.47							
2.44	0.38	0.62	0.86	1.10	1.34	1.58	1.82	2.06	2.24	2.48	2.72	2.96	3.20								
102	2.59	4.38	7.14	9.89	12.65	15.40	18.15	20.91	23.66	25.73	28.48	31.23	33.99	36.74							
2.59	0.41	0.66	0.92	1.17	1.43	1.69	1.94	2.20	2.39	2.65	2.90	3.16	3.41								
108	2.74	4.65	7.58	10.50	13.43	16.35	19.28	22.20	25.12	27.32	30.24	33.17	36.09	39.01							
2.74	0.43	0.70	0.98	1.25	1.52	1.79	2.06	2.33	2.54	2.81	3.08	3.35	3.62								
114	2.90	4.93	8.02	11.11	14.21	17.30	20.40	23.49	26.59	28.91	32.00	35.10	38.19	41.29							
2.90	0.46	0.75	1.03	1.32	1.61	1.90	2.19	2.47	2.69	2.97	3.26	3.55	3.84								
120	3.05	5.20	8.46	11.73	14.99	18.26	21.52	24.79	28.05	30.50	33.77	37.03	40.30	43.56							
3.05	0.48	0.79	1.09	1.39	1.70	2.00	2.30	2.61	2.83	3.14	3.44	3.74	4.05								



<b>SCHEDULE TYPE:</b>	Page 2 of 3			
<b>PROJECT:</b>	Dimensions are in inches (mm).			
<b>ENGINEER:</b>	<b>DATE</b>	<b>B SERIES</b>	<b>SUPERSEDES</b>	<b>DRAWING NO.</b>
<b>CONTRACTOR:</b>	3 - 12 - 24	1600	1 - 27 - 23	1604DHP



**EXTRUDED ALUMINUM STATIONARY LOUVER  
4" (102) DEEP • HIGH PERFORMANCE  
DRAINABLE BLADE • PERFORMANCE DATA  
MODEL: 1604DHP**

**AIRFLOW/WATER PENETRATION DATA  
for 48" x 48" (1219 x 1219) Louver Size**

	Free Area %	57%
	Free Area sq. ft. (sq. m.)	9.11 (0.85)
I N T A K E	Free Area Velocity at Point of Beginning Water Penetration at .01 oz./sq. ft. (3 ml/sq. m) (15 min. test duration)	954 fpm (291 m/min.)
	Air Volume at 954 fpm	8,691 cfm (4101 l/s)
	Free Area Velocity	
	Pressure Drop @ 954 fpm	.14 in. w.g. (35 Pa)

**NOTE:** To minimize water penetration when sizing intake louvers, select a Free Area Velocity that is **below** the point of beginning water penetration.

**PRESSURE DROP**

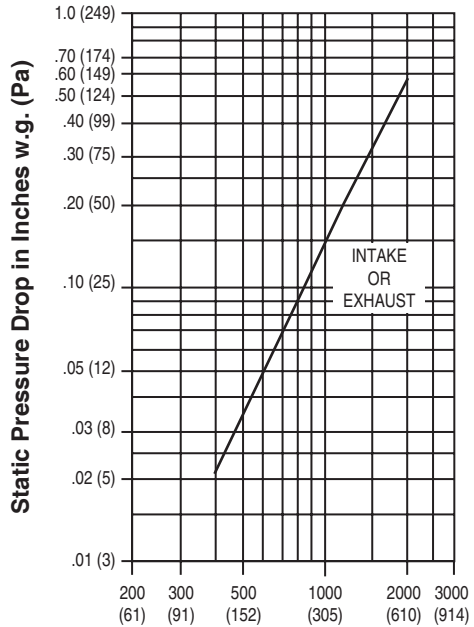

**Air Velocity in Feet (Meters) Per Minute Through Free Area**

Louver test size: 48" x 48" (1219 x 1219 mm).

Standard air density @ 0.075 lbs/ft<sup>3</sup>.

Tested to AMCA Fig. 5.5 - 6.5.



Nailor Industries Inc. certifies that the Model 1604DHP shown herein is licensed to bear the AMCA Certified Ratings Program seal. The ratings shown are based on tests and procedures performed in accordance with AMCA Publication 511 and comply with the requirements of the AMCA Certified Ratings Program. The AMCA Certified Ratings Program seal applies to Water Penetration and Air Performance ratings.

Louvers were tested in accordance with AMCA Standard 500-L.



<b>SCHEDULE TYPE:</b>	Page 3 of 3			
<b>PROJECT:</b>	Dimensions are in inches (mm).			
<b>ENGINEER:</b>	<b>DATE</b>	<b>B SERIES</b>	<b>SUPERSEDES</b>	<b>DRAWING NO.</b>
<b>CONTRACTOR:</b>	3 - 12 - 24	1600	1 - 27 - 23	1604DHP



**EXTRUDED ALUMINUM STATIONARY LOUVER**  
**4" (102) DEEP • J BLADE • DRAINABLE HEAD**  
**MODEL: 1604JD**

Model 1604JD, incorporating J style blades, is an architecturally styled 4" (102) deep louver designed with smooth, clean lines that visually compliment any structure's exterior styling. Available in channel or flanged type, the 4" (102) deep frame installs easily in most common wall configurations. The drainable head feature utilizes a top gutter that collects the water running down the building face and channels it out the concealed downspouts in the side frame, thus preventing it from flowing down into the airstream. Suitable for use in exhaust and low to medium velocity intake applications, the blade design features a rear water baffle and provides good protection against general weather conditions, with low pressure drop characteristics and a high free area. Reinforcing bosses run the full length of each blade for superior strength. Model 1604JD is AMCA Licensed and is engineered to be architecturally appealing as well as mechanically enduring.

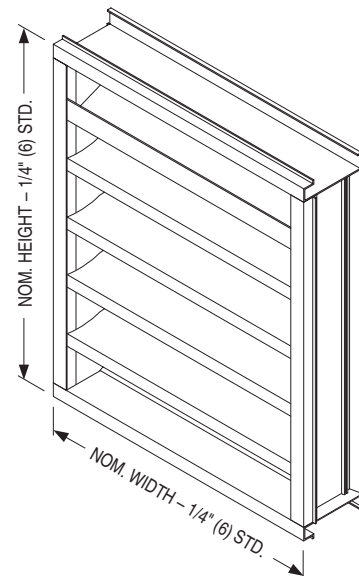

**STANDARD CONSTRUCTION:**

- FRAME:** 4" (102) deep, Type 6063-T6 extruded aluminum, .080" (2.03) nominal wall thickness. Integral caulking slot provided.
- BLADES:** Type 6063-T6 extruded aluminum, .080" (2.03) nominal wall thickness, with reinforcing bosses. J style.
- BLADE ANGLE:** Fixed at 37 degrees.
- BLADE SPACING:** Approx. 4" (102) on centers.
- BLADE SUPPORT BRACKETS:** Concealed type, factory installed on rear of louver on maximum 60" (1524) centers. Reinforced with 1 1/2" x 2" (38 x 51) angle (adds approx. 2" [51] to overall louver depth).
- MULLIONS:** Concealed type allowing continuous line appearance up to 120" (3048) wide. Larger assemblies require separate visible frames with downspouts.
- SCREEN:** 3/4" x .051 (19 x 1.3) expanded, flattened aluminum bird screen in removable frame, inside (rear) mount (adds approximately 3/8" [10] to louver depth).
- FINISH:** Mill.
- MINIMUM SIZE:** 12" W x 12" H (305 x 305).
- MAX. SINGLE SECTION SIZE:** 120" W x 84" H (3048 x 2134) or 84" W x 120" H (2134 x 3048). 70 sq. ft. (6.5m<sup>2</sup>). Larger louvers will require field assembly of smaller sections.

**OPTIONS:**

- FL15** Flanged Frame, 1 1/2" (38).
- FL20** Flanged Frame, 2" (51).
- BSSS** Type 304 S.S. Bird Screen.
- BSN** No Bird Screen.
- ISA** Aluminum Insect Screen.
- ISSS** Type 304 S.S. Insect Screen.
- WE** Welded Construction.
- ESI** Extended Sill.
- FR1** 1" (25) Filter Rack.
- FR2** 2" (51) Filter Rack.
- PACA** Perimeter Anchor Clips.
- Other: \_\_\_\_\_

**OPTIONAL FINISHES:**

- PC3** Powder Coat AAMA 2603. Color: \_\_\_\_\_
- PC4** High Performance Powder Coat AAMA 2604 (Equivalent to 50% Kynar®). Color: \_\_\_\_\_
- PC5** Fluoropolymer Powder Coat AAMA 2605 (Equivalent to 70% Kynar®). Color: \_\_\_\_\_
- PCC** Prime Coat.
- AN04** Clear Anodized 204-R1.
- AN15** Clear Anodized 215-R1.

Color Anodized:

- ANLB** Light Bronze.       **ANMB** Medium Bronze.
- ANDB** Dark Bronze.       **ANBK** Black.

**OPTIONAL W x H SIZING** (1/4" [6.5] Undersize standard):

- U00** Exact Size.
- U38** Undersize 3/8" (9.5).
- U50** Undersize 1/2" (12.7).

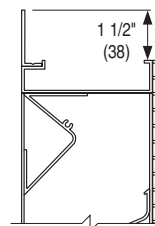

OPT. FLANGED FRAME (FL15 STD.)

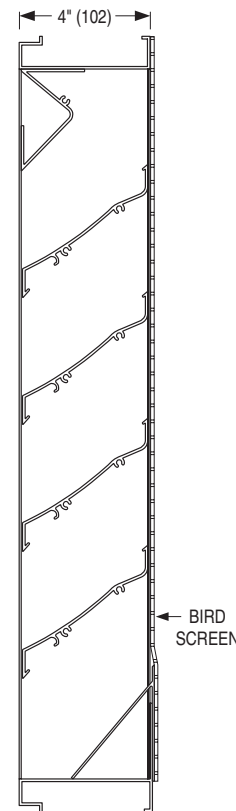

**SCHEDULE TYPE:**

**PROJECT:**

**ENGINEER:**

**CONTRACTOR:**

DATE	B SERIES	SUPERSEDES	DRAWING NO.
3 - 12 - 24	1600	2 - 17 - 22	1604JD



**EXTRUDED ALUMINUM STATIONARY LOUVER**  
**4" (102) DEEP • J BLADE • DRAINABLE HEAD**  
**PERFORMANCE DATA**  
**MODEL: 1604JD**

**FREE AREA in Square Feet and Square Meters**

		Width in Inches and Meters																		
		12	18	24	30	36	42	48	54	60	66	72	78	84	90	96	102	108	114	120
		0.30	0.46	0.61	0.76	0.91	1.07	1.22	1.37	1.52	1.68	1.83	1.98	2.13	2.29	2.44	2.59	2.74	2.90	3.05
Height in Inches and Meters	12	0.16	0.26	0.36	0.46	0.56	0.65	0.75	0.85	0.95	1.05	1.15	1.25	1.35	1.44	1.54	1.64	1.74	1.84	1.94
	0.30	0.02	0.02	0.03	0.04	0.05	0.06	0.07	0.08	0.09	0.10	0.11	0.12	0.12	0.13	0.14	0.15	0.16	0.17	0.18
	18	0.35	0.56	0.78	0.99	1.21	1.42	1.63	1.85	2.06	2.28	2.49	2.70	2.92	3.13	3.34	3.56	3.77	3.99	4.20
	0.46	0.03	0.05	0.07	0.09	0.11	0.13	0.15	0.17	0.19	0.21	0.23	0.25	0.27	0.29	0.31	0.33	0.35	0.37	0.39
	24	0.89	1.43	1.97	2.51	3.05	3.59	4.13	4.67	5.22	5.76	6.30	6.84	7.38	7.92	8.46	9.00	9.54	10.08	10.63
	0.61	0.08	0.13	0.18	0.23	0.28	0.33	0.38	0.43	0.48	0.53	0.59	0.64	0.69	0.74	0.79	0.84	0.89	0.94	0.99
	30	1.16	1.87	2.58	3.29	4.00	4.71	5.41	6.12	6.83	7.54	8.25	8.96	9.67	10.37	11.08	11.79	12.50	13.21	13.92
	0.76	0.11	0.17	0.24	0.31	0.37	0.44	0.50	0.57	0.63	0.70	0.77	0.83	0.90	0.96	1.03	1.10	1.16	1.23	1.29
	36	1.41	2.27	3.12	3.98	4.84	5.70	6.56	7.42	8.28	9.13	9.99	10.85	11.71	12.57	13.43	14.29	15.14	16.00	16.86
	0.91	0.13	0.21	0.29	0.37	0.45	0.53	0.61	0.69	0.77	0.85	0.93	1.01	1.09	1.17	1.25	1.33	1.41	1.49	1.57
	42	1.71	2.75	3.80	4.84	5.88	6.93	7.97	9.01	10.06	11.10	12.14	13.19	14.23	15.27	16.32	17.36	18.40	19.45	20.49
	1.07	0.16	0.26	0.35	0.45	0.55	0.64	0.74	0.84	0.93	1.03	1.13	1.23	1.32	1.42	1.52	1.61	1.71	1.81	1.90
	48	1.94	3.12	4.31	5.49	6.67	7.85	9.04	10.22	11.40	12.59	13.77	14.95	16.14	17.32	18.50	19.68	20.87	22.05	23.23
	1.22	0.18	0.29	0.40	0.51	0.62	0.73	0.84	0.95	1.06	1.17	1.28	1.39	1.50	1.61	1.72	1.83	1.94	2.05	2.16
	54	2.26	3.64	5.02	6.39	7.77	9.15	10.53	11.90	13.28	14.66	16.04	17.42	18.79	20.17	21.55	22.93	24.31	25.68	27.06
	1.37	0.21	0.34	0.47	0.59	0.72	0.85	0.98	1.11	1.23	1.36	1.49	1.62	1.75	1.87	2.00	2.13	2.26	2.39	2.51
60	2.49	4.01	5.52	7.04	8.56	10.08	11.59	13.11	14.63	16.15	17.66	19.18	20.70	22.22	23.73	25.25	26.77	28.29	29.80	
1.52	0.23	0.37	0.51	0.65	0.80	0.94	1.08	1.22	1.36	1.50	1.64	1.78	1.92	2.06	2.20	2.35	2.49	2.63	2.77	
66	2.77	4.46	6.15	7.84	9.52	11.21	12.90	14.59	16.28	17.97	19.66	21.35	23.04	24.72	26.41	28.10	29.79	31.48	33.17	
1.68	0.26	0.41	0.57	0.73	0.88	1.04	1.20	1.36	1.51	1.67	1.83	1.98	2.14	2.30	2.45	2.61	2.77	2.92	3.08	
72	3.04	4.90	6.75	8.61	10.46	12.32	14.18	16.03	17.89	19.74	21.60	23.45	25.31	27.16	29.02	30.88	32.73	34.59	36.44	
1.83	0.28	0.46	0.63	0.80	0.97	1.14	1.32	1.49	1.66	1.83	2.01	2.18	2.35	2.52	2.70	2.87	3.04	3.21	3.39	
78	3.49	5.63	7.76	9.89	12.02	14.15	16.28	18.41	20.54	22.67	24.81	26.94	29.07	31.20	33.33	35.46	37.59	39.72	41.86	
1.98	0.32	0.52	0.72	0.92	1.12	1.31	1.51	1.71	1.91	2.11	2.30	2.50	2.70	2.90	3.10	3.29	3.49	3.69	3.89	
84	3.59	5.78	7.97	10.16	12.35	14.54	16.73	18.92	21.11	23.30	25.49	27.68	29.87	32.06	34.25	36.44	38.63	40.82	43.01	
2.13	0.33	0.54	0.74	0.94	1.15	1.35	1.55	1.76	1.96	2.16	2.37	2.57	2.78	2.98	3.18	3.39	3.59	3.79	4.00	
90	3.87	6.22	8.58	10.94	13.29	15.65	18.01	20.37	22.72	25.08	27.44	29.80	32.15							
2.29	0.36	0.58	0.80	1.02	1.24	1.45	1.67	1.89	2.11	2.33	2.55	2.77	2.99							
96	4.14	6.66	9.19	11.71	14.24	16.76	19.29	21.81	24.34	26.86	29.39	31.91	34.44							
2.44	0.38	0.62	0.85	1.09	1.32	1.56	1.79	2.03	2.26	2.50	2.73	2.96	3.20							
102	4.39	7.06	9.74	12.42	15.09	17.77	20.44	23.12	25.80	28.47	31.15	33.83	36.50							
2.59	0.41	0.66	0.90	1.15	1.40	1.65	1.90	2.15	2.40	2.65	2.89	3.14	3.39							
108	4.69	7.55	10.41	13.27	16.13	18.99	21.85	24.71	27.57	30.43	33.29	36.15	39.01							
2.74	0.44	0.70	0.97	1.23	1.50	1.76	2.03	2.30	2.56	2.83	3.09	3.36	3.62							
114	4.91	7.91	10.91	13.90	16.90	19.90	22.90	25.89	28.89	31.89	34.88	37.88	40.88							
2.90	0.46	0.73	1.01	1.29	1.57	1.85	2.13	2.41	2.68	2.96	3.24	3.52	3.80							
120	5.24	8.43	11.63	14.82	18.01	21.21	24.40	27.60	30.79	33.98	37.18	40.37	43.57							
3.05	0.49	0.78	1.08	1.38	1.67	1.97	2.27	2.56	2.86	3.16	3.45	3.75	4.05							



<b>SCHEDULE TYPE:</b>	Page 2 of 3			
<b>PROJECT:</b>	Dimensions are in inches (mm).			
<b>ENGINEER:</b>	<b>DATE</b>	<b>B SERIES</b>	<b>SUPERSEDES</b>	<b>DRAWING NO.</b>
<b>CONTRACTOR:</b>	3 - 12 - 24	1600	2 - 17 - 22	1604JD





**EXTRUDED ALUMINUM STATIONARY LOUVER  
4" (102) DEEP • J BLADE • DRAINABLE HEAD  
PERFORMANCE DATA  
MODEL: 1604JD**

**AIRFLOW/WATER PENETRATION DATA  
for 48" x 48" (1219 x 1219) Louver Size**

	Free Area %	57%
	Free Area sq. ft. (sq. m.)	9.04 (0.84)
I N T A K E	Free Area Velocity at Point of Beginning Water Penetration at .01 oz./sq. ft. (3 ml/sq. m) (15 min. test duration)	978 fpm (298 m/min.)
	Air Volume at 978 fpm	8851 cfm (4177 l/s)
	Free Area Velocity	
	Pressure Drop @ 978 fpm	.17 in. w.g. (42 Pa)

**NOTE:** To minimize water penetration when sizing intake louvers, select a Free Area Velocity that is **below** the point of beginning water penetration.

**PRESSURE DROP**

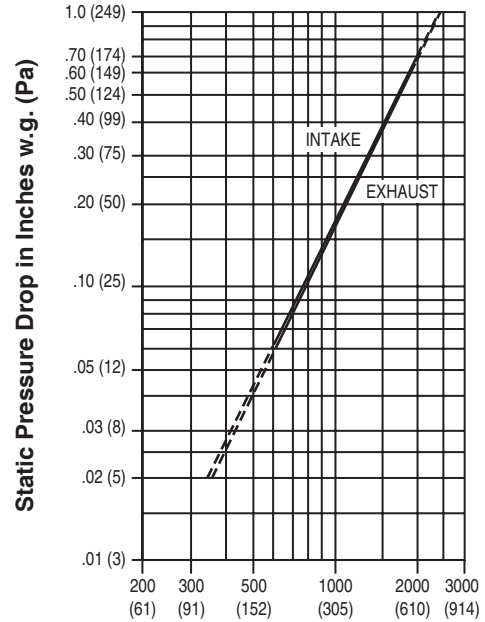

**Air Velocity in Feet (Meters) Per Minute Through Free Area**

Louver test size: 48" x 48" (1219 x 1219 mm).

Standard air density @ 0.075 lbs/ft<sup>3</sup>.

Tested to AMCA Fig. 5.5 – 6.5.



Nailor Industries Inc. certifies that the Model 1604JD shown herein is licensed to bear the AMCA Certified Ratings Program seal. The ratings shown are based on tests and procedures performed in accordance with AMCA Publication 511 and comply with the requirements of the AMCA Certified Ratings Program. The AMCA Certified Ratings Program seal applies to Water Penetration and Air Performance ratings.

Louvers were tested in accordance with AMCA Standard 500-L.



<b>SCHEDULE TYPE:</b>	Page 3 of 3			
<b>PROJECT:</b>	Dimensions are in inches (mm).			
<b>ENGINEER:</b>	<b>DATE</b>	<b>B SERIES</b>	<b>SUPERSEDES</b>	<b>DRAWING NO.</b>
<b>CONTRACTOR:</b>	3 - 12 - 24	1600	2 - 17 - 22	1604JD



**EXTRUDED ALUMINUM STATIONARY LOUVER**  
**4" (102) DEEP • K BLADE • DRAINABLE HEAD**  
**MODEL: 1604KD**

Model 1604KD, 4" (102) deep louver, combines good weather protection and performance with aesthetics that compliment any architecture. The design features a drainable head that collects the water running down the building face and channels it out the concealed downspouts in the side frame, thus preventing it from flowing down into the airstream. Suitable for use in exhaust and low to medium velocity intake applications, the K blade design features a rear water baffle plus an additional center rain hook, providing good protection against more forbidding weather conditions. Blades are reinforced with full length integral bosses for superior strength and the profile exhibits low pressure drop characteristics throughout the airflow range. Model 1604KD is available with channel or flanged type frame to suit most architectural and mechanical installation requirements and is AMCA Licensed.

**STANDARD CONSTRUCTION:**

- FRAME:** 4" (102) deep, Type 6063-T6 extruded aluminum, .080" (2.03) nominal wall thickness. Integral caulking slot provided.
- BLADES:** Type 6063-T6 extruded aluminum, .080" (2.03) nominal wall thickness, with reinforcing bosses. K style.
- BLADE ANGLE:** Fixed at 37 degrees.
- BLADE SPACING:** Approx. 4" (102) on centers.
- BLADE SUPPORT BRACKETS:** Concealed type, factory installed on rear of louver on maximum 60" (1524) centers. Reinforced with 1 1/2" x 2" (38 x 51) angle (adds approx. 2" [51] to overall louver depth).
- MULLIONS:** Concealed type allowing continuous line appearance up to 120" (3048) wide. Larger assemblies require separate visible frames with downspouts.
- SCREEN:** 3/4" x .051 (19 x 1.3) expanded, flattened aluminum bird screen in removable frame, inside (rear) mount (adds approximately 3/8" [10] to louver depth).
- FINISH:** Mill.
- MINIMUM SIZE:** 12" W x 12" H (305 x 305).
- MAX. SINGLE SECTION SIZE:** 120" W x 84" H (3048 x 2134) or 84" W x 120" H (2134 x 3048). 70 sq. ft. (6.5m<sup>2</sup>). Larger louvers will require field assembly of smaller sections.

**OPTIONS:**

- FL** Flanged Frame.
- BSSS** Type 304 S.S. Bird Screen.
- BSN** No Bird Screen.
- ISA** Aluminum Insect Screen.
- ISSS** Type 304 S.S. Insect Screen.
- WE** Welded Construction.
- ESI** Extended Sill.
- FR1** 1" (25) Filter Rack.
- FR2** 2" (51) Filter Rack.
- PAC** Perimeter Anchor Clips.
- Other:** \_\_\_\_\_

**OPTIONAL FINISHES:**

- PC3** Powder Coat AAMA 2603. Color: \_\_\_\_\_.
- PC4** High Performance Powder Coat AAMA 2604 (Equivalent to 50% Kynar®). Color: \_\_\_\_\_.
- PC5** Fluoropolymer Powder Coat AAMA 2605 (Equivalent to 70% Kynar®). Color: \_\_\_\_\_.
- PCC** Prime Coat.
- AN04** Clear Anodized 204-R1.
- AN15** Clear Anodized 215-R1.

Color Anodized:

- ANLB** Light Bronze.
- ANDB** Dark Bronze.
- ANMB** Medium Bronze.
- ANBK** Black.

**OPTIONAL W x H SIZING** (1/4" [6.5] Undersize standard):

- U00** Exact Size.
- U38** Undersize 3/8" (9.5).
- U50** Undersize 1/2" (12.7).

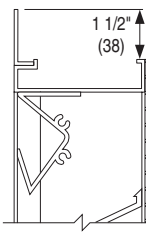
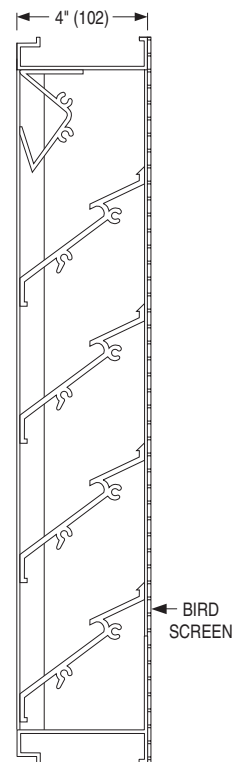
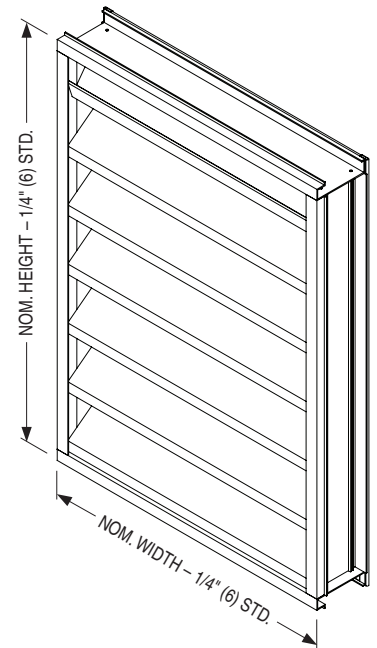

FLANGED FRAME (FL)  
(OPTIONAL)

**SCHEDULE TYPE:**

**PROJECT:**

**ENGINEER:**

**CONTRACTOR:**

Page 1 of 3  
 Dimensions are in inches (mm).

DATE	B SERIES	SUPERSEDES	DRAWING NO.
2 - 17 - 22	1600	7 - 11 - 13	1604KD



**EXTRUDED ALUMINUM STATIONARY LOUVER  
4" (102) DEEP • K BLADE • DRAINABLE HEAD  
PERFORMANCE DATA  
MODEL: 1604KD**

**FREE AREA in Square Feet and Square Meters**

		Width in Inches and Meters																		
		12 0.30	18 0.46	24 0.61	30 0.76	36 0.91	42 1.07	48 1.22	54 1.37	60 1.52	66 1.68	72 1.83	78 1.98	84 2.13	90 2.29	96 2.44	102 2.59	108 2.74	114 2.90	120 3.05
Height in Inches and Meters	12 0.30	0.21 0.02	0.34 0.03	0.47 0.04	0.60 0.06	0.73 0.07	0.85 0.08	0.98 0.09	1.11 0.10	1.24 0.12	1.37 0.13	1.49 0.14	1.62 0.15	1.75 0.16	1.88 0.17	2.01 0.19	2.13 0.20	2.26 0.21	2.39 0.22	2.52 0.23
	18 0.46	0.46 0.04	0.74 0.07	1.02 0.09	1.30 0.12	1.58 0.15	1.86 0.17	2.14 0.20	2.41 0.22	2.69 0.25	2.97 0.28	3.25 0.30	3.53 0.33	3.81 0.35	4.09 0.38	4.37 0.41	4.64 0.43	4.92 0.46	5.20 0.48	5.48 0.51
	24 0.61	0.73 0.07	1.17 0.11	1.60 0.15	2.04 0.19	2.48 0.23	2.91 0.27	3.35 0.31	3.79 0.35	4.22 0.39	4.66 0.43	5.10 0.47	5.53 0.51	5.97 0.55	6.41 0.60	6.85 0.64	7.28 0.68	7.72 0.72	8.16 0.76	8.59 0.80
	30 0.76	0.93 0.09	1.49 0.14	2.05 0.19	2.61 0.24	3.17 0.29	3.74 0.35	4.30 0.40	4.86 0.45	5.42 0.50	5.98 0.56	6.54 0.61	7.10 0.66	7.66 0.71	8.22 0.76	8.78 0.82	9.34 0.87	9.90 0.92	10.46 0.97	11.02 1.02
	36 0.91	1.15 0.11	1.85 0.17	2.54 0.24	3.23 0.30	3.93 0.36	4.62 0.43	5.31 0.49	6.00 0.56	6.70 0.62	7.39 0.69	8.08 0.75	8.77 0.82	9.47 0.88	10.16 0.94	10.85 1.01	11.54 1.07	12.24 1.14	12.93 1.20	13.62 1.27
	42 1.07	1.40 0.13	2.24 0.21	3.08 0.29	3.93 0.36	4.77 0.44	5.61 0.52	6.45 0.60	7.29 0.68	8.13 0.76	8.97 0.83	9.81 0.91	10.66 0.99	11.50 1.07	12.34 1.15	13.18 1.22	14.02 1.30	14.86 1.38	15.70 1.46	16.54 1.54
	48 1.22	1.62 0.15	2.59 0.24	3.56 0.33	4.53 0.42	5.50 0.51	6.48 0.60	7.51 0.70	8.42 0.78	9.39 0.87	10.36 0.96	11.33 1.05	12.30 1.14	13.28 1.23	14.25 1.32	15.22 1.41	16.19 1.50	17.16 1.59	18.13 1.68	19.10 1.77
	54 1.37	1.84 0.17	2.95 0.27	4.06 0.38	5.16 0.48	6.27 0.58	7.37 0.68	8.48 0.79	9.58 0.89	10.69 0.99	11.80 1.10	12.90 1.20	14.01 1.30	15.11 1.40	16.22 1.51	17.33 1.61	18.43 1.71	19.54 1.82	20.64 1.92	21.75 2.02
	60 1.52	2.09 0.19	3.34 0.31	4.59 0.43	5.84 0.54	7.10 0.66	8.35 0.78	9.60 0.89	10.85 1.01	12.11 1.12	13.36 1.24	14.61 1.36	15.86 1.47	17.12 1.59	18.37 1.71	19.62 1.82	20.87 1.94	22.13 2.06	23.38 2.17	24.63 2.29
	66 1.68	2.31 0.21	3.69 0.34	5.07 0.47	6.46 0.60	7.84 0.73	9.23 0.86	10.61 0.99	12.00 1.11	13.38 1.24	14.76 1.37	16.15 1.50	17.53 1.63	18.92 1.76	20.30 1.89	21.68 2.01	23.07 2.14	24.45 2.27	25.84 2.40	27.22 2.53
	72 1.83	2.55 0.24	4.08 0.38	5.62 0.52	7.15 0.66	8.68 0.81	10.21 0.95	11.74 1.09	13.27 1.23	14.80 1.38	16.34 1.52	17.87 1.66	19.40 1.80	20.93 1.94	22.46 2.09	23.99 2.23	25.53 2.37	27.06 2.51	28.59 2.66	30.12 2.80
	78 1.98	2.77 0.26	4.43 0.41	6.10 0.57	7.76 0.72	9.42 0.88	11.08 1.03	12.75 1.18	14.41 1.34	16.07 1.49	17.74 1.65	19.40 1.80	21.06 1.96	22.72 2.11	24.39 2.27	26.05 2.42	27.71 2.57	29.37 2.73	31.04 2.88	32.70 3.04
	84 2.13	2.99 0.28	4.79 0.45	6.59 0.61	8.38 0.78	10.18 0.95	11.98 1.11	13.77 1.28	15.57 1.45	17.37 1.61	19.16 1.78	20.96 1.95	22.76 2.11	24.55 2.28	26.35 2.45	28.15 2.61	29.94 2.78	31.74 2.95	33.54 3.12	35.33 3.28
	90 2.29	3.24 0.30	5.18 0.48	7.12 0.66	9.07 0.84	11.01 1.02	12.95 1.20	14.90 1.38	16.84 1.56	18.78 1.74	20.72 1.93	22.67 2.11	24.61 2.29	26.55 2.47	28.49 2.65	30.44 2.83	32.38 3.01	34.32 3.19	36.27 3.37	38.21 3.55
	96 2.44	3.46 0.32	5.53 0.51	7.61 0.71	9.68 0.90	11.76 1.09	13.83 1.29	15.91 1.48	17.99 1.67	20.06 1.86	22.14 2.06	24.21 2.25	26.29 2.44	28.36 2.63	30.44 2.83	32.51 3.02	34.59 3.21	36.66 3.41	38.74 3.60	40.81 3.79
	102 2.59	3.68 0.34	5.89 0.55	8.10 0.75	10.31 0.96	12.52 1.16	14.73 1.37	16.94 1.57	19.15 1.78	21.36 1.98	23.56 2.19	25.77 2.39	27.98 2.60	30.19 2.80	32.40 3.01	34.61 3.22	36.82 3.42	39.03 3.63	41.24 3.83	43.45 4.04
108 2.74	3.92 0.36	6.28 0.58	8.63 0.80	10.99 1.02	13.34 1.24	15.69 1.46	18.05 1.68	20.40 1.90	22.76 2.11	25.11 2.33	27.46 2.55	29.82 2.77	32.17 2.99	34.53 3.21	36.88 3.43	39.23 3.64	41.59 3.86	43.94 4.08	46.30 4.30	
114 2.90	4.15 0.39	6.63 0.62	9.12 0.85	11.61 1.08	14.10 1.31	16.58 1.54	19.07 1.77	21.56 2.00	24.05 2.23	26.53 2.46	29.02 2.70	31.51 2.93	34.00 3.16	36.48 3.39	38.97 3.62	41.46 3.85	43.95 4.08	46.43 4.31	48.92 4.54	
120 3.05	4.39 0.41	7.02 0.65	9.66 0.90	12.29 1.14	14.93 1.39	17.56 1.63	20.19 1.88	22.83 2.12	25.46 2.37	28.10 2.61	30.73 2.85	33.36 3.10	36.00 3.34	38.63 3.59	41.27 3.83	43.90 4.08	46.53 4.32	49.17 4.57	51.80 4.81	



**SCHEDULE TYPE:**

**PROJECT:**

**ENGINEER:**

**CONTRACTOR:**

Page 2 of 3  
Dimensions are in inches (mm).

**DATE**

**B SERIES**

**SUPERSEDES**

**DRAWING NO.**

2 - 17 - 22

1600

7 - 11 - 13

1604KD



**EXTRUDED ALUMINUM STATIONARY LOUVER  
4" (102) DEEP • K BLADE • DRAINABLE HEAD  
PERFORMANCE DATA  
MODEL: 1604KD**

**AIRFLOW/WATER PENETRATION DATA  
for 48" x 48" (1219 x 1219) Louver Size**

Free Area %	47%	
Free Area sq. ft. (sq. m.)	7.51 (0.70)	
I N T A K E	Free Area Velocity at Point of Beginning Water Penetration at .01 oz./sq. ft. (3 ml/sq. m) (15 min. test duration)	892 fpm (272 m/min.)
	Air Volume at 892 fpm	6699 cfm (3161 l/s)
	Free Area Velocity	
	Pressure Drop @ 892 fpm	.11 in. w.g. (27 Pa)

**NOTE:** To minimize water penetration when sizing intake louvers, select a Free Area Velocity that is **below** the point of beginning water penetration.



Nailor Industries Inc. certifies the Model 1604KD shown herein is licensed to bear the AMCA Seal. The ratings shown are based on tests and procedures performed in accordance with AMCA Publication 511 and comply with the requirements of the AMCA Certified Ratings Program. Seal applies to air performance ratings and water penetration ratings.

**PRESSURE DROP**

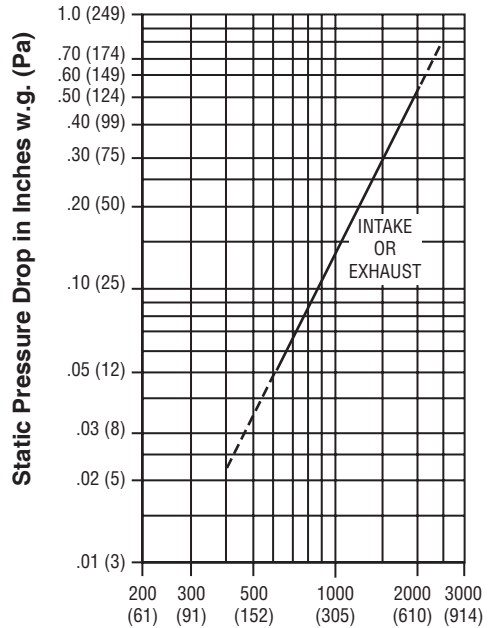

**Air Velocity in Feet (Meters) Per Minute Through Free Area**  
Louver test size: 48" x 48" (1219 x 1219 mm).  
Standard air density @ 0.075 lbs/ft<sup>3</sup>.  
Tested to AMCA Fig. 5.5 – 6.5.

<b>SCHEDULE TYPE:</b>	Page 3 of 3			
<b>PROJECT:</b>	Dimensions are in inches (mm).			
<b>ENGINEER:</b>	<b>DATE</b>	<b>B SERIES</b>	<b>SUPERSEDES</b>	<b>DRAWING NO.</b>
<b>CONTRACTOR:</b>	2 - 17 - 22	1600	7 - 11 - 13	1604KD



**EXTRUDED ALUMINUM STATIONARY LOUVER**  
**6" (152) DEEP • DRAINABLE BLADE**  
**MODEL: 1606D**

Nailor Model 1606D is designed to provide excellent weather protection in non-wind driven rain conditions with great air performance and pleasing aesthetics that compliment any structure's exterior styling. The drainable head feature is enhanced by the drainable blade design which utilizes additional rain gutters that divert collected water through concealed side downspouts and out the sill, effectively preventing water from infiltrating the space. Blades are reinforced with full length integral bosses for superior strength. Suitable for use in exhaust and low to medium velocity intake applications where water penetration concerns are a priority. Available in channel, flanged, or glazing adapter type, the 6" (152) deep frame installs easily in most common wall configurations.

**STANDARD CONSTRUCTION:**

- FRAME:** 6" (152) deep, Type 6063-T6 extruded aluminum, .080" (2.03) nominal wall thickness. Integral downspouts and caulking slot provided.
- BLADES:** Type 6063-T6 extruded aluminum, .080" (2.03) nominal wall thickness, with reinforcing bosses.
- BLADE ANGLE:** Fixed at 37/45 degrees.
- BLADE SPACING:** Approximately 5 1/4" (133) on centers.
- BLADE SUPPORT BRACKETS:** Concealed type, factory installed on rear of louver on maximum 60" (1524) centers. Reinforced with 1 1/2" x 2" (38 x 51) angle (adds approx. 2" [51] to overall louver depth).
- MULLIONS:** Concealed type allowing continuous line appearance up to 120" (3048) wide. Larger assemblies require separate visible frames with downspouts.
- SCREEN:** 3/4" x .051 (19 x 1.3) expanded, flattened aluminum bird screen in removable frame, inside (rear) mount (adds approximately 3/8" [10] to louver depth).
- FINISH:** Mill.
- MINIMUM SIZE:** 12" W x 12" H (305 x 305).
- MAX. SINGLE SECTION SIZE:** 120" W x 84" H (3048 x 2134) or 84" W x 120" H (2134 x 3048). 70 sq. ft. (6.5m<sup>2</sup>).  
 Larger louvers will require field assembly of smaller sections.

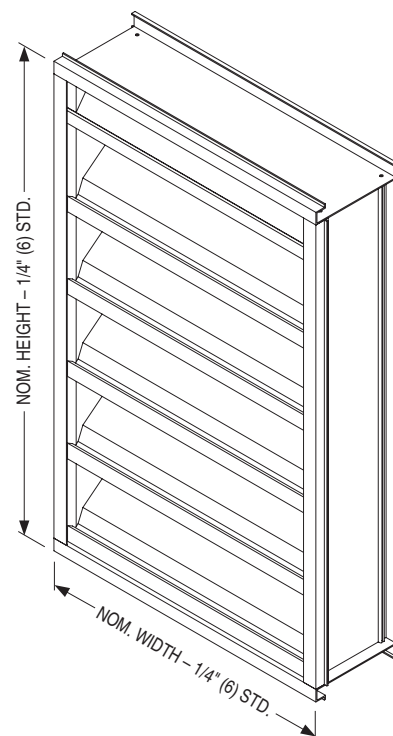

**OPTIONS:**

- FL15** Flanged Frame, 1 1/2" (38).
- FL20** Flanged Frame, 2" (51).
- BSSS** Type 304 S.S. Bird Screen.
- BSN** No Bird Screen.
- ISA** Aluminum Insect Screen.
- ISSS** Type 304 S.S. Insect Screen.
- WE** Welded Construction.
- ESI** Extended Sill.
- FR1** 1" (25) Filter Rack.
- FR2** 2" (51) Filter Rack.
- PACA** Perimeter Anchor Clips.
- Other:** \_\_\_\_\_

**OPTIONAL FINISHES:**

- PC3** Powder Coat AAMA 2603. Color: \_\_\_\_\_
- PC4** High Performance Powder Coat AAMA 2604 (Equivalent to 50% Kynar®). Color: \_\_\_\_\_
- PC5** Fluoropolymer Powder Coat AAMA 2605 (Equivalent to 70% Kynar®). Color: \_\_\_\_\_
- PCC** Prime Coat.
- AN04** Clear Anodized 204-R1.
- AN15** Clear Anodized 215-R1.

Color Anodized:

- ANLB** Light Bronze.       **ANMB** Medium Bronze.
- ANDB** Dark Bronze.       **ANBK** Black.

**OPTIONAL W x H SIZING** (1/4" [6.5] Undersize standard):

- U00** Exact Size.
- U38** Undersize 3/8" (9.5).
- U50** Undersize 1/2" (12.7).

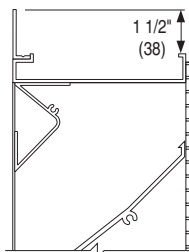

OPT. FLANGED FRAME (FL15 STD.)

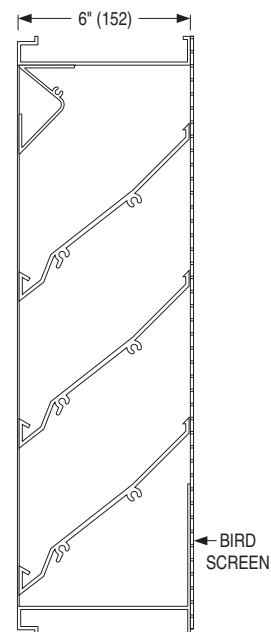

**SCHEDULE TYPE:**

**PROJECT:**

**ENGINEER:**

**CONTRACTOR:**

Page 1 of 3  
 Dimensions are in inches (mm).

DATE	B SERIES	SUPERSEDES	DRAWING NO.
3 - 12 - 24	1600	2 - 17 - 22	1606D



**EXTRUDED ALUMINUM STATIONARY LOUVER  
6" (152) DEEP • DRAINABLE BLADE  
PERFORMANCE DATA  
MODEL: 1606D**

**FREE AREA in Square Feet and Square Meters**

		Width in Inches and Meters																		
		12	18	24	30	36	42	48	54	60	66	72	78	84	90	96	102	108	114	120
Height in Inches and Meters	12	0.30	0.46	0.61	0.76	0.91	1.07	1.22	1.37	1.52	1.68	1.83	1.98	2.13	2.29	2.44	2.59	2.74	2.90	3.05
	18	0.46	0.61	0.76	0.91	1.07	1.22	1.37	1.52	1.68	1.83	1.98	2.13	2.29	2.44	2.59	2.74	2.90	3.05	3.20
	24	0.61	0.76	0.91	1.07	1.22	1.37	1.52	1.68	1.83	1.98	2.13	2.29	2.44	2.59	2.74	2.90	3.05	3.20	3.35
	30	0.76	0.91	1.07	1.22	1.37	1.52	1.68	1.83	1.98	2.13	2.29	2.44	2.59	2.74	2.90	3.05	3.20	3.35	3.50
	36	0.91	1.07	1.22	1.37	1.52	1.68	1.83	1.98	2.13	2.29	2.44	2.59	2.74	2.90	3.05	3.20	3.35	3.50	3.65
	42	1.07	1.22	1.37	1.52	1.68	1.83	1.98	2.13	2.29	2.44	2.59	2.74	2.90	3.05	3.20	3.35	3.50	3.65	3.80
	48	1.22	1.37	1.52	1.68	1.83	1.98	2.13	2.29	2.44	2.59	2.74	2.90	3.05	3.20	3.35	3.50	3.65	3.80	3.95
	54	1.37	1.52	1.68	1.83	1.98	2.13	2.29	2.44	2.59	2.74	2.90	3.05	3.20	3.35	3.50	3.65	3.80	3.95	4.10
	60	1.52	1.68	1.83	1.98	2.13	2.29	2.44	2.59	2.74	2.90	3.05	3.20	3.35	3.50	3.65	3.80	3.95	4.10	4.25
	66	1.68	1.83	1.98	2.13	2.29	2.44	2.59	2.74	2.90	3.05	3.20	3.35	3.50	3.65	3.80	3.95	4.10	4.25	4.40
	72	1.83	1.98	2.13	2.29	2.44	2.59	2.74	2.90	3.05	3.20	3.35	3.50	3.65	3.80	3.95	4.10	4.25	4.40	4.55
	78	1.98	2.13	2.29	2.44	2.59	2.74	2.90	3.05	3.20	3.35	3.50	3.65	3.80	3.95	4.10	4.25	4.40	4.55	4.70
	84	2.13	2.29	2.44	2.59	2.74	2.90	3.05	3.20	3.35	3.50	3.65	3.80	3.95	4.10	4.25	4.40	4.55	4.70	4.85
	90	2.29	2.44	2.59	2.74	2.90	3.05	3.20	3.35	3.50	3.65	3.80	3.95	4.10	4.25	4.40	4.55	4.70	4.85	5.00
	96	2.44	2.59	2.74	2.90	3.05	3.20	3.35	3.50	3.65	3.80	3.95	4.10	4.25	4.40	4.55	4.70	4.85	5.00	5.15
	102	2.59	2.74	2.90	3.05	3.20	3.35	3.50	3.65	3.80	3.95	4.10	4.25	4.40	4.55	4.70	4.85	5.00	5.15	5.30
108	2.74	2.90	3.05	3.20	3.35	3.50	3.65	3.80	3.95	4.10	4.25	4.40	4.55	4.70	4.85	5.00	5.15	5.30	5.45	
114	2.90	3.05	3.20	3.35	3.50	3.65	3.80	3.95	4.10	4.25	4.40	4.55	4.70	4.85	5.00	5.15	5.30	5.45	5.60	
120	3.05	3.20	3.35	3.50	3.65	3.80	3.95	4.10	4.25	4.40	4.55	4.70	4.85	5.00	5.15	5.30	5.45	5.60	5.75	



<b>SCHEDULE TYPE:</b>	Page 2 of 3			
<b>PROJECT:</b>	Dimensions are in inches (mm).			
<b>ENGINEER:</b>	<b>DATE</b>	<b>B SERIES</b>	<b>SUPERSEDES</b>	<b>DRAWING NO.</b>
<b>CONTRACTOR:</b>	3 - 12 - 24	1600	2 - 17 - 22	1606D





**EXTRUDED ALUMINUM STATIONARY LOUVER  
6" (152) DEEP • DRAINABLE BLADE  
PERFORMANCE DATA  
MODEL: 1606D**

**AIRFLOW/WATER PENETRATION DATA  
for 48" x 48" (1219 x 1219) Louver Size**

	Free Area %	51%
	Free Area sq. ft. (sq. m.)	8.10 (0.75)
I N T A K E	Free Area Velocity at Point of Beginning Water Penetration at .01 oz./sq. ft. (3 ml/sq. m) (15 min. test duration)	1195 fpm (364 m/min.)
	Air Volume at 1195 fpm	9680 cfm (4568 l/s)
	Free Area Velocity	
	Pressure Drop @ 1195 fpm	.15 in. w.g. (37 Pa)

**NOTE:** To minimize water penetration when sizing intake louvers, select a Free Area Velocity that is **below** the point of beginning water penetration.

**PRESSURE DROP**

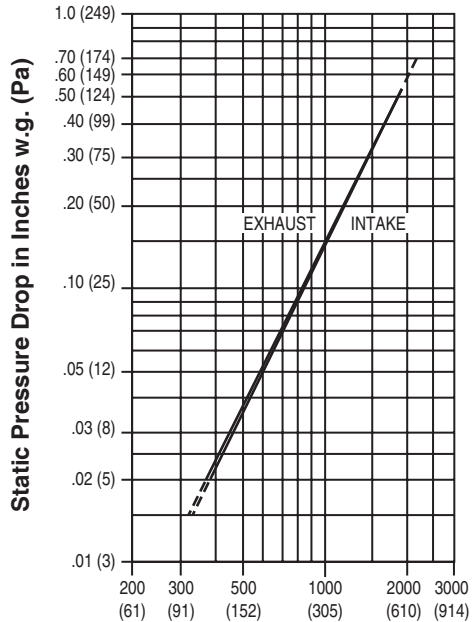

**Air Velocity in Feet (Meters) Per Minute Through Free Area**

Louver test size: 48" x 48" (1219 x 1219 mm).

Standard air density @ 0.075 lbs/ft<sup>3</sup>.

Tested to AMCA Fig. 5.5 - 6.5.



Nailor Industries Inc. certifies that the Model 1606D shown herein is licensed to bear the AMCA Certified Ratings Program seal. The ratings shown are based on tests and procedures performed in accordance with AMCA Publication 511 and comply with the requirements of the AMCA Certified Ratings Program. The AMCA Certified Ratings Program seal applies to Water Penetration and Air Performance ratings.

Louvers were tested in accordance with AMCA Standard 500-L.



<b>SCHEDULE TYPE:</b>	Page 3 of 3			
<b>PROJECT:</b>	Dimensions are in inches (mm).			
<b>ENGINEER:</b>	<b>DATE</b>	<b>B SERIES</b>	<b>SUPERSEDES</b>	<b>DRAWING NO.</b>
<b>CONTRACTOR:</b>	3 - 12 - 24	1600	2 - 17 - 22	1606D



# EXTRUDED ALUMINUM STATIONARY LOUVER 6" (152) DEEP • DUAL DRAINABLE BLADE MODEL: 1606DD

Nailor Model 1606DD combines exceptional weather protection during the most enduring non-wind driven rain conditions, great air performance through a large free area and a clean look that will enhance the exterior of any structure. Complemented by a drainable head, the dual drainable blade design features double rain gutters that divert cascading water running down the building's face down concealed side downspouts and out through the sill, preventing water from infiltrating the space. Blades are reinforced with full length integral bosses for superior strength. Suitable for use in exhaust and medium to high velocity intake applications where water penetration concerns are a top priority. Available in channel, flanged, or glazing adapter type, the 6" (152) deep frame installs easily in most common wall configurations. Nailor Model 1606DD is AMCA Licensed for Water Penetration and Air Performance.

### STANDARD CONSTRUCTION:

- FRAME:** 6" (152) deep, Type 6063-T6 extruded aluminum, .080" (2.03) nominal wall thickness. Integral downspouts and caulking slot provided.
- BLADES:** Type 6063-T6 extruded aluminum, .080" (2.03) nominal wall thickness, with reinforcing bosses.
- BLADE ANGLE:** Fixed at 37 degrees.
- BLADE SPACING:** Approx. 6" (152) on centers.
- BLADE SUPPORT BRACKETS:** Concealed type, factory installed on rear of louver on maximum 60" (1524) centers. Reinforced with 1 1/2" x 2" (38 x 51) angle (adds approx. 2" [51] to overall louver depth).
- MULLIONS:** Concealed type allowing continuous line appearance up to 120" (3048) wide. Larger assemblies require separate visible frames with downspouts.
- SCREEN:** 3/4" x .051 (19 x 1.3) expanded, flattened aluminum bird screen in removable frame, inside (rear) mount (adds approximately 3/8" [10] to louver depth).
- FINISH:** Mill.
- MINIMUM SIZE:** 12" W x 12" H (305 x 305).
- MAX. SINGLE SECTION SIZE:** 120" W x 84" H (3048 x 2134) or 84" W x 120" H (2134 x 3048). 70 sq. ft. (6.5m<sup>2</sup>). Larger louvers will require field assembly of smaller sections.

### OPTIONS:

- |   |  |
|---|--|
| <input type="checkbox"/> <b>FL15</b> Flanged Frame, 1 1/2" (38).  | <input type="checkbox"/> <b>WE</b> Welded Construction.      |
| <input type="checkbox"/> <b>FL20</b> Flanged Frame, 2" (51).      | <input type="checkbox"/> <b>ESI</b> Extended Sill.           |
| <input type="checkbox"/> <b>BSSS</b> Type 304 S.S. Bird Screen.   | <input type="checkbox"/> <b>FR1</b> 1" (25) Filter Rack.     |
| <input type="checkbox"/> <b>BSN</b> No Bird Screen.               | <input type="checkbox"/> <b>FR2</b> 2" (51) Filter Rack.     |
| <input type="checkbox"/> <b>ISA</b> Aluminum Insect Screen.       | <input type="checkbox"/> <b>PACA</b> Perimeter Anchor Clips. |
| <input type="checkbox"/> <b>ISSS</b> Type 304 S.S. Insect Screen. | <input type="checkbox"/> <b>Other:</b> _____                 |

### OPTIONAL FINISHES:

- PC3** Powder Coat AAMA 2603. Color: \_\_\_\_\_ .
- PC4** High Performance Powder Coat AAMA 2604 (Equivalent to 50% Kynar®). Color: \_\_\_\_\_ .
- PC5** Fluoropolymer Powder Coat AAMA 2605 (Equivalent to 70% Kynar®). Color: \_\_\_\_\_ .
- PCC** Prime Coat.
- AN04** Clear Anodized 204-R1.
- AN15** Clear Anodized 215-R1.

Color Anodized:

- |  |   |
|--|---|
| <input type="checkbox"/> <b>ANLB</b> Light Bronze. | <input type="checkbox"/> <b>ANMB</b> Medium Bronze. |
| <input type="checkbox"/> <b>ANDB</b> Dark Bronze.  | <input type="checkbox"/> <b>ANBK</b> Black.         |

### OPTIONAL W x H SIZING (1/4" [6.5] Undersize standard):

- U00** Exact Size.
- U38** Undersize 3/8" (9.5).
- U50** Undersize 1/2" (12.7).

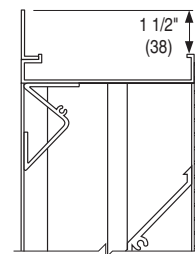
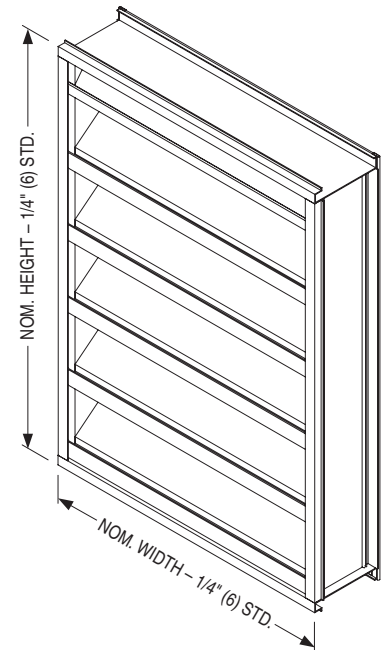

OPT. FLANGED FRAME (FL15 STD.)

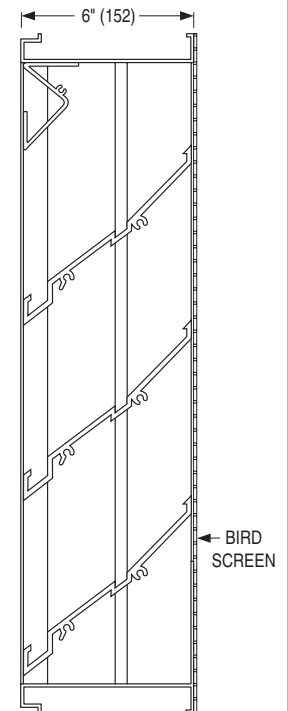

BIRD SCREEN

### SCHEDULE TYPE:

PROJECT:

ENGINEER:

CONTRACTOR:

Page 1 of 3  
Dimensions are in inches (mm).

DATE	B SERIES	SUPERSEDES	DRAWING NO.
3 - 12 - 24	1600	2 - 17 - 22	1606DD



**EXTRUDED ALUMINUM LOUVER**  
**6" (152) DEEP • DUAL DRAINABLE BLADE**  
**PERFORMANCE DATA**  
**MODEL: 1606DD**

**FREE AREA in Square Feet and Square Meters**

		Width in Inches and Meters																			
		12 0.30	18 0.46	24 0.61	30 0.76	36 0.91	42 1.07	48 1.22	54 1.37	60 1.52	66 1.68	72 1.83	78 1.98	84 2.13	90 2.29	96 2.44	102 2.59	108 2.74	114 2.90	120 3.05	
Height in Inches and Meters	12 0.30	0.18 0.02	0.29 0.03	0.39 0.04	0.50 0.05	0.61 0.06	0.72 0.07	0.82 0.08	0.93 0.09	1.04 0.10	1.15 0.11	1.25 0.12	1.36 0.13	1.47 0.14	1.58 0.15	1.68 0.16	1.79 0.17	1.90 0.18	2.01 0.19	2.11 0.20	
	18 0.46	0.43 0.04	0.69 0.06	0.95 0.09	1.21 0.11	1.47 0.14	1.73 0.16	1.99 0.19	2.25 0.21	2.51 0.23	2.77 0.26	3.03 0.28	3.29 0.31	3.55 0.33	3.81 0.35	4.07 0.38	4.33 0.40	4.59 0.43	4.85 0.45	5.11 0.47	
	24 0.61	0.69 0.06	1.10 0.10	1.51 0.14	1.92 0.18	2.33 0.22	2.75 0.26	3.16 0.29	3.57 0.33	3.98 0.37	4.40 0.41	4.81 0.45	5.22 0.48	5.63 0.52	6.04 0.56	6.46 0.60	6.87 0.64	7.28 0.68	7.69 0.71	8.10 0.75	
	30 0.76	0.95 0.09	1.51 0.14	2.08 0.19	2.65 0.25	3.22 0.30	3.78 0.35	4.35 0.40	4.92 0.46	5.49 0.51	6.05 0.56	6.62 0.62	7.19 0.67	7.76 0.72	8.32 0.77	8.89 0.83	9.46 0.88	10.02 0.93	10.59 0.98	11.16 1.04	
	36 0.91	1.21 0.11	1.93 0.18	2.65 0.25	3.37 0.31	4.10 0.38	4.82 0.45	5.54 0.51	6.27 0.58	6.99 0.65	7.71 0.72	8.44 0.78	9.16 0.85	9.88 0.92	10.60 0.99	11.33 1.05	12.05 1.12	12.77 1.19	13.50 1.25	14.22 1.32	
	42 1.07	1.46 0.14	2.34 0.22	3.22 0.30	4.10 0.38	4.98 0.46	5.86 0.54	6.74 0.63	7.62 0.71	8.50 0.79	9.37 0.87	10.25 0.95	11.13 1.03	12.01 1.12	12.89 1.20	13.77 1.28	14.65 1.36	15.53 1.44	16.41 1.52	17.28 1.61	
	48 1.22	1.72 0.16	2.76 0.26	3.79 0.35	4.83 0.45	5.86 0.54	6.90 0.64	7.92 0.74	8.96 0.83	10.00 0.93	11.03 1.03	12.07 1.12	13.10 1.22	14.14 1.31	15.17 1.41	16.21 1.51	17.24 1.60	18.27 1.70	19.31 1.79	20.34 1.89	
	54 1.37	1.98 0.18	3.17 0.29	4.36 0.41	5.55 0.52	6.74 0.63	7.93 0.74	9.12 0.85	10.31 0.96	11.50 1.07	12.69 1.18	13.88 1.29	15.07 1.40	16.26 1.51	17.45 1.62	18.64 1.73	19.83 1.84	21.02 1.95	22.21 2.06	23.40 2.17	
	60 1.52	2.30 0.21	3.68 0.34	5.06 0.47	6.44 0.60	7.81 0.73	9.19 0.85	10.57 0.98	11.95 1.11	13.33 1.24	14.71 1.37	16.09 1.49	17.47 1.62	18.85 1.75	20.22 1.88	21.60 2.01	22.98 2.14	24.36 2.26	25.74 2.39	27.12 2.52	
	66 1.68	2.50 0.23	4.00 0.37	5.50 0.51	7.01 0.65	8.51 0.79	10.01 0.93	11.51 1.07	13.01 1.21	14.51 1.35	16.01 1.49	17.52 1.63	19.02 1.77	20.52 1.91	22.02 2.05	23.52 2.19	25.02 2.32	26.52 2.46	28.03 2.60	29.53 2.74	
	72 1.83	2.77 0.26	4.44 0.41	6.10 0.57	7.76 0.72	9.43 0.88	11.09 1.03	12.75 1.18	14.42 1.34	16.08 1.49	17.74 1.65	19.41 1.80	21.07 1.96	22.73 2.11	24.40 2.27	26.06 2.42	27.72 2.58	29.39 2.73	31.05 2.88	32.71 3.04	
	78 1.98	3.02 0.28	4.83 0.45	6.65 0.62	8.46 0.79	10.27 0.95	12.09 1.12	13.90 1.29	15.71 1.46	17.53 1.63	19.34 1.80	21.15 1.96	22.96 2.13	24.78 2.30	26.59 2.47	28.40 2.64	30.22 2.81	32.03 2.98	33.84 3.14	35.65 3.31	
	84 2.13	3.28 0.30	5.25 0.49	7.22 0.67	9.19 0.85	11.15 1.04	13.12 1.22	15.09 1.40	17.06 1.58	19.03 1.77	21.00 1.95	22.97 2.13	24.93 2.32	26.90 2.50	28.87 2.68	30.84 2.86	32.81 3.05	34.78 3.23	36.74 3.41	38.71 3.60	
	90 2.29	3.54 0.33	5.66 0.53	7.79 0.72	9.91 0.92	12.04 1.12	14.16 1.32	16.28 1.51	18.41 1.71	20.53 1.91	22.66 2.10	24.78 2.30	26.90 2.50	29.03 2.70							
	96 2.44	3.80 0.35	6.08 0.56	8.36 0.78	10.64 0.99	12.92 1.20	15.20 1.41	17.48 1.62	19.76 1.84	22.04 2.05	24.32 2.26	26.60 2.47	28.88 2.68	31.16 2.89							
	102 2.59	4.06 0.38	6.49 0.60	8.93 0.83	11.36 1.06	13.80 1.28	16.24 1.51	18.67 1.73	21.11 1.96	23.54 2.19	25.98 2.41	28.41 2.64	30.85 2.87	33.28 3.09							
108 2.74	4.32 0.40	6.91 0.64	9.50 0.88	12.09 1.12	14.68 1.36	17.27 1.60	19.87 1.85	22.46 2.09	25.05 2.33	27.64 2.57	30.23 2.81	32.82 3.05	35.41 3.29								
114 2.90	4.58 0.43	7.32 0.68	10.07 0.94	12.82 1.19	15.56 1.45	18.31 1.70	21.06 1.96	23.80 2.21	26.55 2.47	29.30 2.72	32.04 2.98	34.79 3.23	37.54 3.49								
120 3.05	4.84 0.45	7.74 0.72	10.64 0.99	13.54 1.26	16.45 1.53	19.35 1.80	22.25 2.07	25.15 2.34	28.06 2.61	30.96 2.88	33.86 3.15	36.76 3.42	39.66 3.68								



<b>SCHEDULE TYPE:</b>	Page 2 of 3			
<b>PROJECT:</b>	Dimensions are in inches (mm).			
<b>ENGINEER:</b>	<b>DATE</b>	<b>B SERIES</b>	<b>SUPERSEDES</b>	<b>DRAWING NO.</b>
<b>CONTRACTOR:</b>	3 - 12 - 24	1600	2 - 17 - 22	1606DD



**EXTRUDED ALUMINUM LOUVER**  
**6" (152) DEEP • DUAL DRAINABLE BLADE**  
**PERFORMANCE DATA**  
**MODEL: 1606DD**

**AIRFLOW/WATER PENETRATION DATA**  
**for 48" x 48" (1219 x 1219) Louver Size**

Free Area %		50%
Free Area sq. ft. (sq. m.)		7.92 (0.74)
I N T A K E	Free Area Velocity at Point of Beginning Water Penetration at .01 oz./sq. ft. (3 ml/sq. m) (15 min. test duration)	906 fpm (276 m/min.)
	Air Volume at 1193 fpm Free Area Velocity	9449 cfm (4459 l/s)
	Pressure Drop @ 1193 fpm	.18 in. w.g. (45 Pa)

**NOTE:** To minimize water penetration when sizing intake louvers, select a Free Area Velocity that is **below** the beginning point of water penetration.

**PRESSURE DROP**

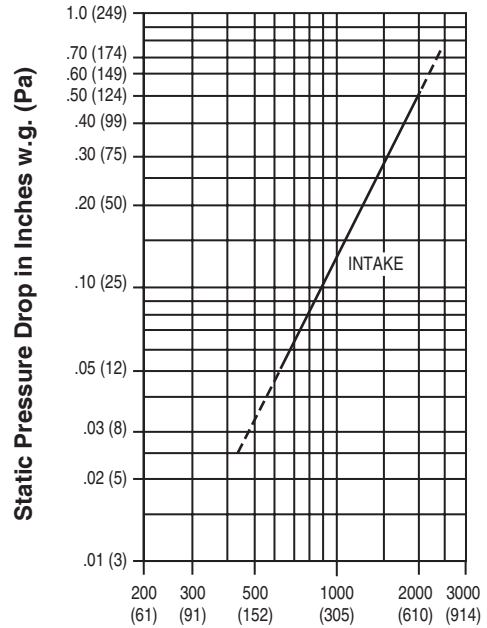

**Air Velocity in Feet (Meters) Per Minute Through Free Area**  
 Louver test size: 48" x 48" (1219 x 1219 mm).  
 Standard air density @ 0.075 lbs/ft<sup>3</sup>.  
 Tested to AMCA Fig. 5.5 – 6.5.



Nailor Industries Inc. certifies that the Model 1606DD shown herein is licensed to bear the AMCA Certified Ratings Program seal. The ratings shown are based on tests and procedures performed in accordance with AMCA Publication 511 and comply with the requirements of the AMCA Certified Ratings Program. The AMCA Certified Ratings Program seal applies to Water Penetration and Air Performance ratings.

Louvers were tested in accordance with AMCA Standard 500-L.



<b>SCHEDULE TYPE:</b>	Page 3 of 3			
<b>PROJECT:</b>	Dimensions are in inches (mm).			
<b>ENGINEER:</b>	<b>DATE</b>	<b>B SERIES</b>	<b>SUPERSEDES</b>	<b>DRAWING NO.</b>
<b>CONTRACTOR:</b>	3 - 12 - 24	1600	2 - 17 - 22	1606DD



**EXTRUDED ALUMINUM STATIONARY LOUVER**  
**6" (152) DEEP • HIGH PERFORMANCE**  
**DRAINABLE BLADE**  
**MODEL: 1606DHP**

Nailor Model 1606DHP is designed to provide excellent weather protection in non-wind driven rain conditions. With its high free area and water penetration velocity, this louver offers a blend of air performance and aesthetics that compliment any structure's exterior styling. The drainable head feature is enhanced by the drainable blade design which utilizes additional rain gutters that divert collected water through concealed side downspouts. Blades are reinforced with full length integral bosses for superior strength. Suitable for use in exhaust and low to medium velocity intake applications where water penetration concerns are a priority. Available in channel, flanged or glazing adapter type, the 6" (152) deep frame installs easily in most common wall configurations.

**STANDARD CONSTRUCTION:**

- FRAME:** 6" (152) deep, Type 6063-T6 extruded aluminum, .080" (2.03) nominal wall thickness. Integral downspouts and caulking slot provided.
- BLADES:** Type 6063-T6 extruded aluminum, .080" (2.03) nominal wall thickness, with reinforcing bosses.
- BLADE ANGLE:** Fixed at 31 degrees.
- BLADE SPACING:** Approximately 4" (102) on centers.
- BLADE SUPPORT BRACKETS:** Concealed type, factory installed on rear of louver on maximum 48" (1219) centers. Reinforced with 1 1/2" x 2" (38 x 51) angle (adds approx. 2" [51] to overall louver depth).
- MULLIONS:** Concealed type allowing continuous line appearance up to 120" (3048) wide. Larger assemblies require separate visible frames with downspouts.
- SCREEN:** 3/4" x .051 (19 x 1.3) expanded, flattened aluminum bird screen in removable frame, inside (rear) mount (adds approximately 3/8" [10] to louver depth).
- FINISH:** Mill.
- MINIMUM SIZE:** 12" W x 12" H (305 x 305).
- MAX. SINGLE SECTION SIZE:** 120" W x 84" H (3048 x 2134) or 84" W x 120" H (2134 x 3048). 70 sq. ft. (6.5m<sup>2</sup>). Larger louvers will require field assembly of smaller sections.

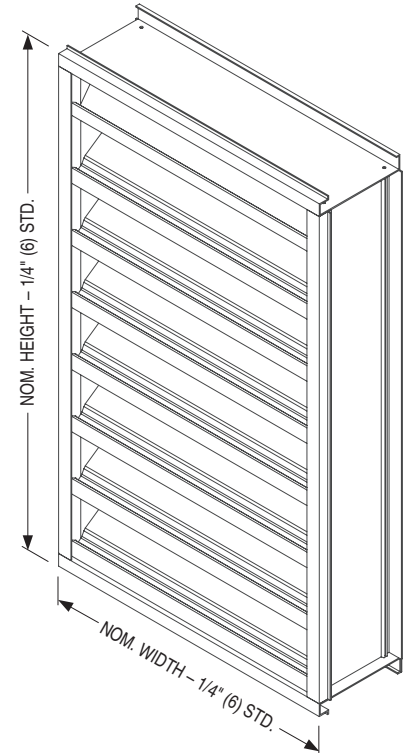

**OPTIONS:**

- FL15** Flanged Frame, 1 1/2" (38).
- FL20** Flanged Frame, 2" (51).
- BSSS** Type 304 S.S. Bird Screen.
- BSN** No Bird Screen.
- ISA** Aluminum Insect Screen.
- ISSS** Type 304 S.S. Insect Screen.
- WE** Welded Construction.
- ESI** Extended Sill.
- FR1** 1" (25) Filter Rack.
- FR2** 2" (51) Filter Rack.
- PACA** Perimeter Anchor Clips.
- Other:** \_\_\_\_\_

**OPTIONAL FINISHES:**

- PC3** Powder Coat AAMA 2603. Color: \_\_\_\_\_.
- PC4** High Performance Powder Coat AAMA 2604 (Equivalent to 50% Kynar®). Color: \_\_\_\_\_.
- PC5** Fluoropolymer Powder Coat AAMA 2605 (Equivalent to 70% Kynar®). Color: \_\_\_\_\_.
- PCC** Prime Coat.
- AN04** Clear Anodized 204-R1.
- AN15** Clear Anodized 215-R1.

Color Anodized:

- ANLB** Light Bronze.       **ANMB** Medium Bronze.
- ANDB** Dark Bronze.       **ANBK** Black.

**OPTIONAL W x H SIZING** (1/4" [6.5] Undersize standard):

- U00** Exact Size.
- U38** Undersize 3/8" (9.5).
- U50** Undersize 1/2" (12.7).

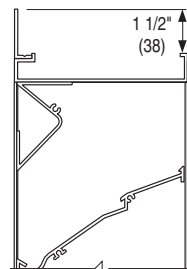

OPT. FLANGED FRAME (FL15 STD.)

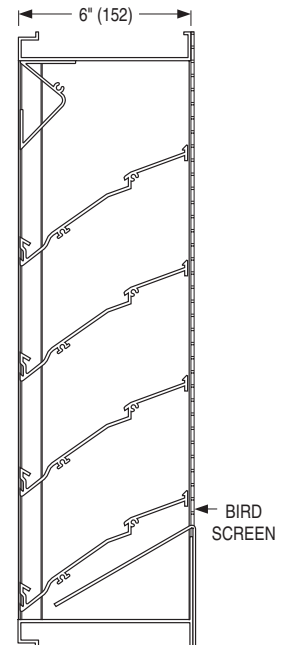

<b>SCHEDULE TYPE:</b>
<b>PROJECT:</b>
<b>ENGINEER:</b>
<b>CONTRACTOR:</b>

Page 1 of 3  
 Dimensions are in inches (mm).

DATE	B SERIES	SUPERSEDES	DRAWING NO.
3 - 12 - 24	1600	2 - 17 - 22	1606DHP



**EXTRUDED ALUMINUM STATIONARY LOUVER  
6" (152) DEEP • HIGH PERFORMANCE  
DRAINABLE BLADE • PERFORMANCE DATA  
MODEL: 1606DHP**

**FREE AREA in Square Feet and Square Meters**

		Width in Inches and Meters																		
		12	18	24	30	36	42	48	54	60	66	72	78	84	90	96	102	108	114	120
Height in Inches and Meters	12	0.31	0.51	0.70	0.89	1.09	1.28	1.48	1.67	1.87	2.06	2.25	2.45	2.64	2.84	3.03	3.22	3.42	3.61	3.81
	0.30	0.03	0.05	0.07	0.08	0.10	0.12	0.14	0.16	0.17	0.19	0.21	0.23	0.25	0.26	0.28	0.30	0.32	0.34	0.35
	18	0.60	0.98	1.35	1.73	2.11	2.48	2.86	3.23	3.61	3.99	4.36	4.74	5.11	5.49	5.87	6.24	6.62	6.99	7.37
	0.46	0.06	0.09	0.13	0.16	0.20	0.23	0.27	0.30	0.34	0.37	0.41	0.44	0.48	0.51	0.54	0.58	0.61	0.65	0.68
	24	0.90	1.47	2.03	2.60	3.16	3.73	4.29	4.85	5.42	5.98	6.55	7.11	7.67	8.24	8.80	9.37	9.93	10.49	11.06
	0.61	0.08	0.14	0.19	0.24	0.29	0.35	0.40	0.45	0.50	0.56	0.61	0.66	0.71	0.77	0.82	0.87	0.92	0.97	1.03
	30	1.19	1.93	2.68	3.42	4.16	4.90	5.64	6.39	7.13	7.87	8.61	9.35	10.10	10.84	11.58	12.32	13.07	13.81	14.55
	0.76	0.11	0.18	0.25	0.32	0.39	0.46	0.52	0.59	0.66	0.73	0.80	0.87	0.94	1.01	1.08	1.14	1.21	1.28	1.35
	36	1.33	2.16	3.00	3.83	4.66	5.49	6.32	7.15	7.98	8.81	9.65	10.48	11.31	12.14	12.97	13.80	14.63	15.46	16.30
	0.36	0.12	0.20	0.28	0.36	0.43	0.51	0.59	0.66	0.74	0.82	0.90	0.97	1.05	1.13	1.20	1.28	1.36	1.44	1.51
	42	1.77	2.87	3.97	5.07	6.17	7.27	8.37	9.47	10.57	11.67	12.78	13.88	14.98	16.08	17.18	18.28	19.38	20.48	21.58
	1.07	0.16	0.27	0.37	0.47	0.57	0.68	0.78	0.88	0.98	1.08	1.19	1.29	1.39	1.49	1.60	1.70	1.80	1.90	2.01
48	2.05	3.33	4.61	5.89	7.17	8.45	9.73	11.01	12.29	13.57	14.85	16.13	17.41	18.69	19.97	21.24	22.52	23.80	25.08	
1.22	0.19	0.31	0.43	0.55	0.67	0.79	0.90	1.02	1.14	1.26	1.38	1.50	1.62	1.74	1.85	1.97	2.09	2.21	2.33	
54	2.34	3.80	5.26	6.73	8.19	9.65	11.11	12.57	14.03	15.49	16.95	18.41	19.87	21.33	22.79	24.25	25.71	27.17	28.64	
1.37	0.22	0.35	0.49	0.62	0.76	0.90	1.03	1.17	1.30	1.44	1.57	1.71	1.85	1.98	2.12	2.25	2.39	2.52	2.66	
60	2.64	4.28	5.92	7.57	9.21	10.86	12.50	14.14	15.79	17.43	19.07	20.72	22.36	24.01	25.65	27.29	28.94	30.58	32.22	
1.52	0.24	0.40	0.55	0.70	0.86	1.01	1.16	1.31	1.47	1.62	1.77	1.92	2.08	2.23	2.38	2.54	2.69	2.84	2.99	
66	2.92	4.74	6.56	8.39	10.21	12.03	13.85	15.67	17.49	19.31	21.13	22.96	24.78	26.60	28.42	30.24	32.06	33.88	35.71	
1.68	0.27	0.44	0.61	0.78	0.95	1.12	1.29	1.46	1.63	1.79	1.96	2.13	2.30	2.47	2.64	2.81	2.98	3.15	3.32	
72	3.21	5.22	7.22	9.22	11.23	13.23	15.24	17.24	19.24	21.25	23.25	25.25	27.26	29.26	31.26	33.27	35.27	37.27	39.28	
1.83	0.30	0.48	0.67	0.86	1.04	1.23	1.42	1.60	1.79	1.97	2.16	2.35	2.53	2.72	2.90	3.09	3.28	3.46	3.65	
78	3.50	5.68	7.87	10.05	12.23	14.41	16.60	18.78	20.96	23.14	25.33	27.51	29.69	31.87	34.05	36.24	38.42	40.60	42.78	
1.98	0.33	0.53	0.73	0.93	1.14	1.34	1.54	1.74	1.95	2.15	2.35	2.56	2.76	2.96	3.16	3.37	3.57	3.77	3.97	
84	3.79	6.16	8.52	10.89	13.25	15.61	17.98	20.34	22.71	25.07	27.43	29.80	32.16	34.53	36.89	39.25	41.62	43.98	46.35	
2.13	0.35	0.57	0.79	1.01	1.23	1.45	1.67	1.89	2.11	2.33	2.55	2.77	2.99	3.21	3.43	3.65	3.87	4.09	4.31	
90	4.08	6.63	9.17	11.72	14.26	16.81	19.35	21.89	24.44	26.98	29.53	32.07	34.62							
2.29	0.38	0.62	0.85	1.09	1.32	1.56	1.80	2.03	2.27	2.51	2.74	2.98	3.22							
96	4.37	7.09	9.82	12.54	15.27	17.99	20.71	23.44	26.16	28.89	31.61	34.33	37.06							
2.44	0.41	0.66	0.91	1.17	1.42	1.67	1.92	2.18	2.43	2.68	2.94	3.19	3.44							
102	4.66	7.57	10.47	13.38	16.28	19.19	22.09	25.00	27.90	30.81	33.71	36.62	39.52							
2.59	0.43	0.70	0.97	1.24	1.51	1.78	2.05	2.32	2.59	2.86	3.13	3.40	3.67							
108	4.95	8.04	11.12	14.21	17.29	20.38	23.46	26.55	29.63	32.72	35.80	38.89	41.97							
2.74	0.46	0.75	1.03	1.32	1.61	1.89	2.18	2.47	2.75	3.04	3.33	3.61	3.90							
114	5.24	8.51	11.78	15.04	18.31	21.58	24.84	28.11	31.38	34.65	37.91	41.18	44.45							
2.90	0.49	0.79	1.09	1.40	1.70	2.00	2.31	2.61	2.92	3.22	3.52	3.83	4.13							
120	5.53	8.98	12.42	15.87	19.31	22.76	26.21	29.65	33.10	36.54	39.99	43.44	46.88							
3.05	0.51	0.83	1.15	1.47	1.79	2.11	2.43	2.75	3.07	3.40	3.72	4.04	4.36							



<b>SCHEDULE TYPE:</b>	Page 2 of 3			
<b>PROJECT:</b>	Dimensions are in inches (mm).			
<b>ENGINEER:</b>	<b>DATE</b>	<b>B SERIES</b>	<b>SUPERSEDES</b>	<b>DRAWING NO.</b>
<b>CONTRACTOR:</b>	3 - 12 - 24	1600	2 - 17 - 22	1606DHP





**EXTRUDED ALUMINUM STATIONARY LOUVER  
6" (152) DEEP • HIGH PERFORMANCE  
DRAINABLE BLADE • PERFORMANCE DATA  
MODEL: 1606DHP**

**AIRFLOW/WATER PENETRATION DATA  
for 48" x 48" (1219 x 1219) Louver Size**

Free Area %		60%
Free Area sq. ft. (sq. m.)		9.65 (0.90)
I N T A K E	Free Area Velocity at Point of Beginning Water Penetration at .01 oz./sq. ft. (3 ml/sq. m) (15 min. test duration)	1186 fpm (361 m/min.)
	Air Volume at 1186 fpm	11,445 cfm (5401 l/s)
	Free Area Velocity	
	Pressure Drop @ 1186 fpm	.19 in. w.g. (47 Pa)

**NOTE:** To minimize water penetration when sizing intake louvers, select a Free Area Velocity that is **below** the point of beginning water penetration.

**PRESSURE DROP**

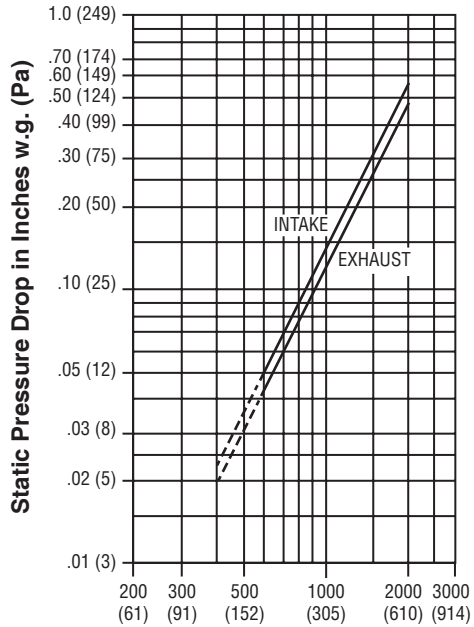

**Air Velocity in Feet (Meters) Per Minute Through Free Area**

Louver test size: 48" x 48" (1219 x 1219 mm).

Standard air density @ 0.075 lbs/ft<sup>3</sup>.

Tested to AMCA Fig. 5.5 - 6.5.



Nailor Industries Inc. certifies that the Model 1606DHP shown herein is licensed to bear the AMCA Certified Ratings Program seal. The ratings shown are based on tests and procedures performed in accordance with AMCA Publication 511 and comply with the requirements of the AMCA Certified Ratings Program. The AMCA Certified Ratings Program seal applies to Water Penetration and Air Performance ratings.

Louvers were tested in accordance with AMCA Standard 500-L.



<b>SCHEDULE TYPE:</b>	Page 3 of 3			
<b>PROJECT:</b>	Dimensions are in inches (mm).			
<b>ENGINEER:</b>	<b>DATE</b>	<b>B SERIES</b>	<b>SUPERSEDES</b>	<b>DRAWING NO.</b>
<b>CONTRACTOR:</b>	3 - 12 - 24	1600	2 - 17 - 22	1606DHP



**EXTRUDED ALUMINUM STATIONARY LOUVER**  
**6" (152) DEEP • J BLADE • DRAINABLE HEAD**  
**MODEL: 1606JD**

Model 1606JD is an architecturally styled 6" (152) deep louver designed with smooth, clean lines that visually compliment any structure's exterior styling. Available in channel or flanged type, the 6" (152) deep frame installs easily in most common wall configurations. The drainable head feature utilizes a top gutter that collects the water running down the building face and channels it out the concealed downspouts in the side frame, thus preventing it from flowing down into the airstream. Suitable for use in exhaust and low to medium velocity intake applications, the blade design features a rear water baffle and provides good protection against general weather conditions, with low pressure drop characteristics and a high free area. Reinforcing bosses run the full length of each blade for superior strength. Model 1606JD is engineered to be architecturally appealing as well as mechanically enduring.

**STANDARD CONSTRUCTION:**

- FRAME:** 6" (152) deep, Type 6063-T6 extruded aluminum, .080" (2.03) nominal wall thickness. Integral caulking slot provided.
- BLADES:** Type 6063-T6 extruded aluminum, .080" (2.03) nominal wall thickness, with reinforcing bosses. J style.
- BLADE ANGLE:** Fixed at 37 degrees.
- BLADE SPACING:** Approximately 5 1/2" (140) on centers.
- BLADE SUPPORT BRACKETS:** Concealed type, factory installed on rear of louver on maximum 60" (1524) centers. Reinforced with 1 1/2" x 2" (38 x 51) angle (adds approx. 2" [51] to overall louver depth).
- MULLIONS:** Concealed type allowing continuous line appearance up to 120" (3048) wide. Larger assemblies require separate visible frames with downspouts.
- SCREEN:** 3/4" x .050 (19 x 1.3) expanded, flattened aluminum bird screen in removable frame, inside (rear) mount (adds approximately 3/8" [10] to louver depth).
- FINISH:** Mill.
- MINIMUM SIZE:** 12" W x 12" H (305 x 305).
- MAX. SINGLE SECTION SIZE:** 120" W x 84" H (3048 x 2134) or 84" W x 120" H (2134 x 3048). 70 sq. ft. (6.5m<sup>2</sup>). Larger louvers will require field assembly of smaller sections.

**OPTIONS:**

- FL15** Flanged Frame, 1 1/2" (38).
- FL20** Flanged Frame, 2" (51).
- BSSS** Type 304 S.S. Bird Screen.
- BSN** No Bird Screen.
- ISA** Aluminum Insect Screen.
- ISSS** Type 304 S.S. Insect Screen.
- WE** Welded Construction.
- ESI** Extended Sill.
- FR1** 1" (25) Filter Rack.
- FR2** 2" (51) Filter Rack.
- PACA** Perimeter Anchor Clips.
- Other:** \_\_\_\_\_

**OPTIONAL FINISHES:**

- PC3** Powder Coat AAMA 2603. Color: \_\_\_\_\_
  - PC4** High Performance Powder Coat AAMA 2604 (Equivalent to 50% Kynar®). Color: \_\_\_\_\_
  - PC5** Fluoropolymer Powder Coat AAMA 2605 (Equivalent to 70% Kynar®). Color: \_\_\_\_\_
  - PCC** Prime Coat.
  - AN04** Clear Anodized 204-R1.
  - AN15** Clear Anodized 215-R1.
- Color Anodized:
- ANLB** Light Bronze.       **ANMB** Medium Bronze.
  - ANDB** Dark Bronze.       **ANBK** Black.

**OPTIONAL W x H SIZING** (1/4" [6.4] Undersize standard):

- U00** Exact Size.
- U38** Undersize 3/8" (9.5).
- U50** Undersize 1/2" (12.7).

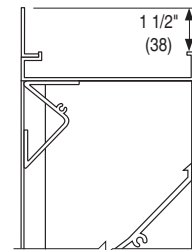
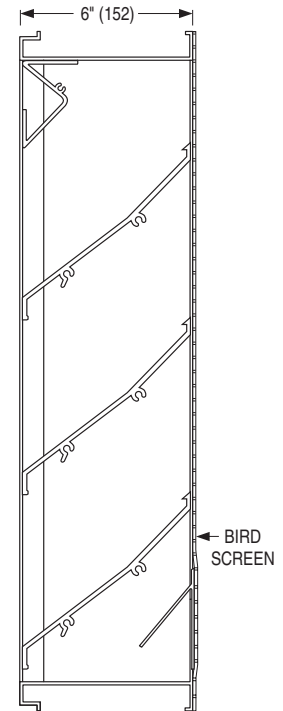
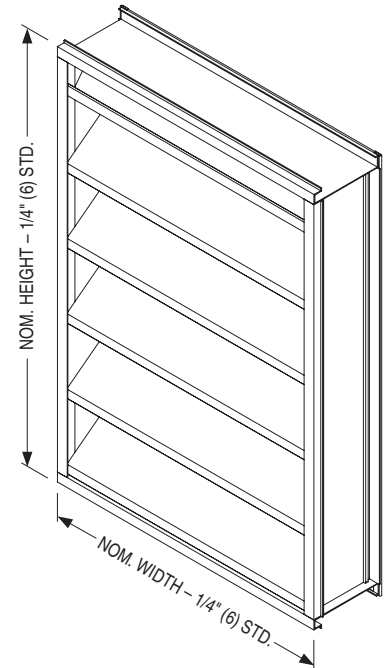

OPT. FLANGED FRAME (FL15 STD.)

<b>SCHEDULE TYPE:</b>
<b>PROJECT:</b>
<b>ENGINEER:</b>
<b>CONTRACTOR:</b>

Page 1 of 3  
Dimensions are in inches (mm).

DATE	B SERIES	SUPERSEDES	DRAWING NO.
3 - 12 - 24	1600	6 - 22 - 21	1606JD



**EXTRUDED ALUMINUM STATIONARY LOUVER  
6" (152) DEEP • J BLADE • DRAINABLE HEAD  
PERFORMANCE DATA  
MODEL: 1606JD**

**FREE AREA in Square Feet and Square Meters**

		Width in Inches and Meters																		
		12	18	24	30	36	42	48	54	60	66	72	78	84	90	96	102	108	114	120
		0.30	0.46	0.61	0.76	0.91	1.07	1.22	1.37	1.52	1.68	1.83	1.98	2.13	2.29	2.44	2.59	2.74	2.90	3.05
Height in Inches and Meters	12	0.26	0.42	0.58	0.75	0.91	1.07	1.23	1.39	1.55	1.71	1.87	2.03	2.19	2.35	2.51	2.67	2.83	2.99	3.15
	0.30	0.02	0.04	0.05	0.07	0.08	0.10	0.11	0.13	0.14	0.16	0.17	0.19	0.20	0.22	0.23	0.25	0.26	0.28	0.29
	18	0.54	0.87	1.20	1.53	1.85	2.18	2.51	2.84	3.17	3.50	3.83	4.16	4.49	4.82	5.14	5.47	5.80	6.13	6.46
	0.46	0.05	0.08	0.11	0.14	0.17	0.20	0.23	0.26	0.29	0.33	0.36	0.39	0.42	0.45	0.48	0.51	0.54	0.57	0.60
	24	0.80	1.29	1.77	2.26	2.75	3.23	3.72	4.21	4.69	5.18	5.67	6.15	6.64	7.13	7.61	8.10	8.59	9.07	9.56
	0.61	0.07	0.12	0.16	0.21	0.26	0.30	0.35	0.39	0.44	0.48	0.53	0.57	0.62	0.66	0.71	0.75	0.80	0.84	0.89
	30	1.06	1.71	2.36	3.00	3.65	4.30	4.95	5.59	6.24	6.89	7.54	8.18	8.83	9.48	10.13	10.77	11.42	12.07	12.72
	0.76	0.10	0.16	0.22	0.28	0.34	0.40	0.46	0.52	0.58	0.64	0.70	0.76	0.82	0.88	0.94	1.00	1.06	1.12	1.18
	36	1.33	2.15	2.96	3.77	4.58	5.40	6.21	7.02	7.84	8.65	9.46	10.27	11.09	11.90	12.71	13.53	14.34	15.15	15.96
	0.91	0.12	0.20	0.27	0.35	0.43	0.50	0.58	0.65	0.73	0.80	0.88	0.95	1.03	1.11	1.18	1.26	1.33	1.41	1.48
	42	1.49	2.41	3.32	4.23	5.14	6.05	6.96	7.87	8.78	9.69	10.60	11.52	12.43	13.34	14.25	15.16	16.07	16.98	17.89
	1.07	0.14	0.22	0.31	0.39	0.48	0.56	0.65	0.73	0.82	0.90	0.99	1.07	1.15	1.24	1.32	1.41	1.49	1.58	1.66
	48	1.70	2.74	3.77	4.81	5.85	6.88	7.88	8.95	9.99	11.03	12.06	13.10	14.14	15.17	16.21	17.25	18.28	19.32	20.36
	1.22	0.16	0.25	0.35	0.45	0.54	0.64	0.73	0.83	0.93	1.02	1.12	1.22	1.31	1.41	1.51	1.60	1.70	1.79	1.89
	54	1.99	3.21	4.42	5.64	6.86	8.07	9.29	10.50	11.72	12.93	14.15	15.37	16.58	17.80	19.01	20.23	21.44	22.66	23.88
	1.37	0.19	0.30	0.41	0.52	0.64	0.75	0.86	0.98	1.09	1.20	1.31	1.43	1.54	1.65	1.77	1.88	1.99	2.11	2.22
60	2.26	3.64	5.02	6.40	7.78	9.15	10.53	11.91	13.29	14.67	16.05	17.43	18.81	20.19	21.56	22.94	24.32	25.70	27.08	
1.52	0.21	0.34	0.47	0.59	0.72	0.85	0.98	1.11	1.23	1.36	1.49	1.62	1.75	1.88	2.00	2.13	2.26	2.39	2.52	
66	2.52	4.06	5.60	7.14	8.68	10.22	11.76	13.30	14.84	16.37	17.91	19.45	20.99	22.53	24.07	25.61	27.15	28.69	30.23	
1.68	0.23	0.38	0.52	0.66	0.81	0.95	1.09	1.24	1.38	1.52	1.66	1.81	1.95	2.09	2.24	2.38	2.52	2.66	2.81	
72	2.80	4.50	6.21	7.91	9.62	11.32	13.03	14.73	16.44	18.14	19.85	21.55	23.26	24.96	26.67	28.37	30.08	31.78	33.49	
1.83	0.26	0.42	0.58	0.73	0.89	1.05	1.21	1.37	1.53	1.69	1.84	2.00	2.16	2.32	2.48	2.64	2.79	2.95	3.11	
78	3.06	4.93	6.80	8.67	10.54	12.40	14.27	16.14	18.01	19.88	21.74	23.61	25.48	27.35	29.22	31.09	32.95	34.82	36.69	
1.98	0.28	0.46	0.63	0.81	0.98	1.15	1.33	1.50	1.67	1.85	2.02	2.19	2.37	2.54	2.71	2.89	3.06	3.23	3.41	
84	3.33	5.36	7.39	9.42	11.46	13.49	15.52	17.55	19.58	21.61	23.64	25.68	27.71	29.74	31.77	33.80	35.83	37.86	39.89	
2.13	0.31	0.50	0.69	0.88	1.06	1.25	1.44	1.63	1.82	2.01	2.20	2.39	2.57	2.76	2.95	3.14	3.33	3.52	3.71	
90	3.60	5.79	7.99	10.18	12.38	14.57	16.76	18.96	21.15	23.35	25.54	27.74	29.93							
2.29	0.33	0.54	0.74	0.95	1.15	1.35	1.56	1.76	1.97	2.17	2.37	2.58	2.78							
96	3.87	6.22	8.58	10.94	13.30	15.65	18.01	20.37	22.73	25.08	27.44	29.80	32.16							
2.44	0.36	0.58	0.80	1.02	1.24	1.45	1.67	1.89	2.11	2.33	2.55	2.77	2.99							
102	4.13	6.65	9.17	11.70	14.22	16.74	19.26	21.78	24.30	26.82	29.34	31.86	34.38							
2.59	0.38	0.62	0.85	1.09	1.32	1.55	1.79	2.02	2.26	2.49	2.73	2.96	3.19							
108	4.40	7.08	9.77	12.45	15.14	17.82	20.50	23.19	25.87	28.56	31.24	33.92	36.61							
2.74	0.41	0.66	0.91	1.16	1.41	1.66	1.90	2.15	2.40	2.65	2.90	3.15	3.40							
114	4.58	7.37	10.16	12.96	15.75	18.54	21.34	24.13	26.92	29.71	32.51	35.30	38.09							
2.90	0.43	0.68	0.94	1.20	1.46	1.72	1.98	2.24	2.50	2.76	3.02	3.28	3.54							
120	4.79	7.72	10.64	13.57	16.49	19.42	22.34	25.27	28.19	31.11	34.04	36.96	39.89							
3.05	0.45	0.72	0.99	1.26	1.53	1.80	2.08	2.35	2.62	2.89	3.16	3.43	3.71							



<b>SCHEDULE TYPE:</b>	Page 2 of 3			
<b>PROJECT:</b>	Dimensions are in inches (mm).			
<b>ENGINEER:</b>	<b>DATE</b>	<b>B SERIES</b>	<b>SUPERSEDES</b>	<b>DRAWING NO.</b>
<b>CONTRACTOR:</b>	3 - 12 - 24	1600	6 - 22 - 21	1606JD



**EXTRUDED ALUMINUM STATIONARY LOUVER  
6" (152) DEEP • J BLADE • DRAINABLE HEAD  
PERFORMANCE DATA  
MODEL: 1606JD**

**AIRFLOW/WATER PENETRATION DATA  
for 48" x 48" (1219 x 1219) Louver Size**

Free Area %	49%	
Free Area sq. ft. (sq. m.)	7.88 (0.73)	
I N T A K E	Free Area Velocity at Point of Beginning Water Penetration at .01 oz./sq. ft. (3 ml/sq. m) (15 min. test duration)	1071 fpm (326 m/min.)
	Air Volume at 1071 fpm	8439 cfm (3983 l/s)
	Free Area Velocity	
	Pressure Drop @ 1071 fpm	.15 in. w.g. (37 Pa)

**NOTE:** To minimize water penetration when sizing intake louvers, select a Free Area Velocity that is **below** the beginning point of water penetration.

**PRESSURE DROP**

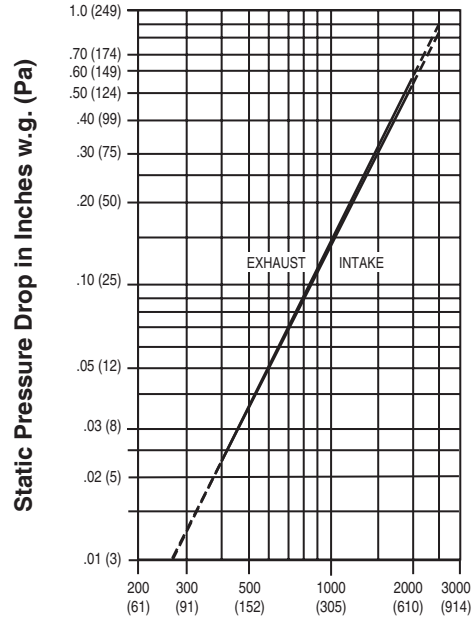

**Air Velocity in Feet (Meters) Per Minute Through Free Area**  
Louver test size: 48" x 48" (1219 x 1219 mm).  
Standard air density @ 0.075 lbs/ft<sup>3</sup>.  
Tested to AMCA Fig. 5.5 – 6.5.



Nailor Industries Inc. certifies that the Model 1606JD shown herein is licensed to bear the AMCA Certified Ratings Program seal. The ratings shown are based on tests and procedures performed in accordance with AMCA Publication 511 and comply with the requirements of the AMCA Certified Ratings Program. The AMCA Certified Ratings Program seal applies to Water Penetration and Air Performance ratings.

Louvers were tested in accordance with AMCA Standard 500-L.



<b>SCHEDULE TYPE:</b>	Page 3 of 3			
<b>PROJECT:</b>	Dimensions are in inches (mm).			
<b>ENGINEER:</b>	<b>DATE</b>	<b>B SERIES</b>	<b>SUPERSEDES</b>	<b>DRAWING NO.</b>
<b>CONTRACTOR:</b>	3 - 12 - 24	1600	6 - 22 - 21	1606JD



**EXTRUDED ALUMINUM STATIONARY LOUVER**  
**6" (152) DEEP • K BLADE • DRAINABLE HEAD**  
**MODEL: 1606KD**

Model 1606KD, 6" (152) deep louver, combines excellent weather protection and performance with aesthetics that compliment any architectural design. Standard construction features a drainable head that collects the water running down the building face and channels it out the concealed downspouts in the side frame, thus preventing it from flowing down into the airstream. Suitable for use in exhaust and low to medium velocity intake applications, the K blade design features a rear water baffle plus an additional center rain hook, providing good protection against foul weather conditions. Blades are reinforced with full length integral bosses for superior strength, and with a large free area, the design is engineered to provide good performance throughout the full airflow range. The 6" (152) deep frame is available in either channel or flanged configuration to suit most architectural and mechanical installation requirements.

**STANDARD CONSTRUCTION:**

- FRAME:** 6" (152) deep, Type 6063-T6 extruded aluminum, .080" (2.03) nominal wall thickness. Integral caulking slot provided.
- BLADES:** Type 6063-T6 extruded aluminum, .080" (2.03) nominal wall thickness, with reinforcing bosses. K style.
- BLADE ANGLE:** Fixed at 37 degrees.
- BLADE SPACING:** Approx. 6" (152) on centers.
- BLADE SUPPORT BRACKETS:** Concealed type, factory installed on rear of louver on maximum 60" (1524) centers. Reinforced with 1 1/2" x 2" (38 x 51) angle (adds approx. 2" [51] to overall louver depth).
- MULLIONS:** Concealed type allowing continuous line appearance up to 120" (3048) wide. Larger assemblies require separate visible frames with downspouts.
- SCREEN:** 3/4" x .051 (19 x 1.3) expanded, flattened aluminum bird screen in removable frame, inside (rear) mount (adds approximately 3/8" [10] to louver depth).
- FINISH:** Mill.
- MINIMUM SIZE:** 12" W x 12" H (305 x 305).
- MAX. SINGLE SECTION SIZE:** 120" W x 84" H (3048 x 2134) or 84" W x 120" H (2134 x 3048). 70 sq. ft. (6.5m<sup>2</sup>). Larger louvers will require field assembly of smaller sections.

**OPTIONS:**

- FL15** Flanged Frame, 1 1/2" (38).
- FL20** Flanged Frame, 2" (51).
- BSSS** Type 304 S.S. Bird Screen.
- BSN** No Bird Screen.
- ISA** Aluminum Insect Screen.
- ISSS** Type 304 S.S. Insect Screen.
- WE** Welded Construction.
- ESI** Extended Sill.
- FR1** 1" (25) Filter Rack.
- FR2** 2" (51) Filter Rack.
- PAC** Perimeter Anchor Clips.
- Other:** \_\_\_\_\_ .

**OPTIONAL FINISHES:**

- PC3** Powder Coat AAMA 2603. Color: \_\_\_\_\_ .
- PC4** High Performance Powder Coat AAMA 2604 (Equivalent to 50% Kynar®). Color: \_\_\_\_\_ .
- PC5** Fluoropolymer Powder Coat AAMA 2605 (Equivalent to 70% Kynar®). Color: \_\_\_\_\_ .
- PCC** Prime Coat.
- AN04** Clear Anodized 204-R1.
- AN15** Clear Anodized 215-R1.

Color Anodized:

- ANLB** Light Bronze.       **ANMB** Medium Bronze.
- ANDB** Dark Bronze.       **ANBK** Black.

**OPTIONAL W x H SIZING** (1/4" [6.5] Undersize standard):

- U00** Exact Size.
- U38** Undersize 3/8" (9.5).
- U50** Undersize 1/2" (12.7).

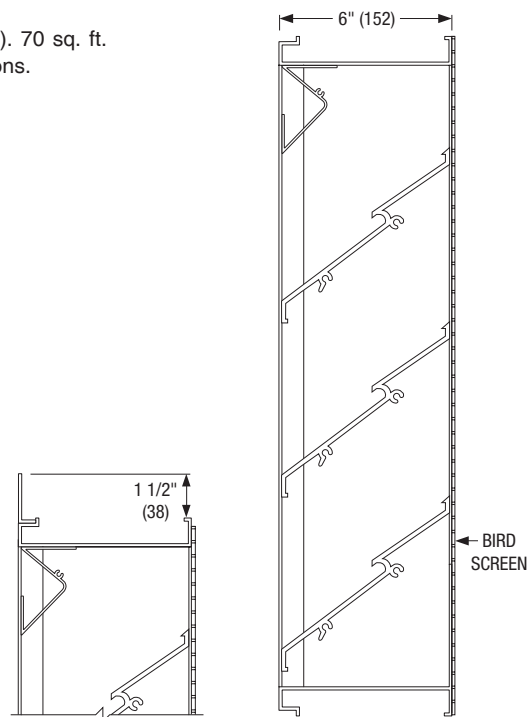
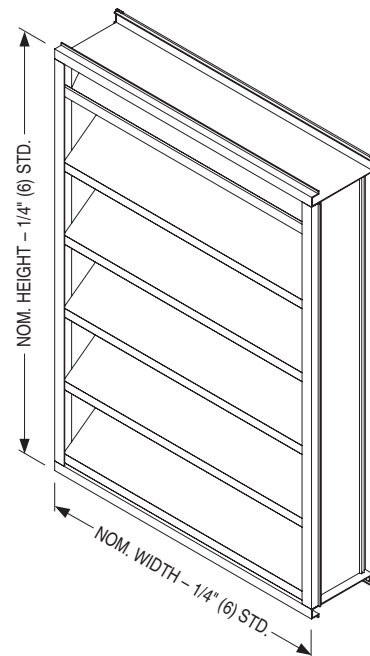

OPT. FLANGED FRAME (FL15 STD.)

<b>SCHEDULE TYPE:</b>				
<b>PROJECT:</b>				
<b>ENGINEER:</b>	<b>DATE</b>	<b>B SERIES</b>	<b>SUPERSEDES</b>	<b>DRAWING NO.</b>
<b>CONTRACTOR:</b>	2 - 19 - 24	1600	2 - 17 - 22	1606KD



**EXTRUDED ALUMINUM STATIONARY LOUVER  
6" (152) DEEP • K BLADE • DRAINABLE HEAD  
PERFORMANCE DATA  
MODEL: 1606KD**

**FREE AREA in Square Feet and Square Meters**

		Width in Inches and Meters																		
		12 0.30	18 0.46	24 0.61	30 0.76	36 0.91	42 1.07	48 1.22	54 1.37	60 1.52	66 1.68	72 1.83	78 1.98	84 2.13	90 2.29	96 2.44	102 2.59	108 2.74	114 2.90	120 3.05
<b>Height in Inches and Meters</b>	12 0.30	0.18 0.02	0.29 0.03	0.39 0.04	0.50 0.05	0.61 0.06	0.72 0.07	0.82 0.08	0.93 0.09	1.04 0.10	1.15 0.11	1.25 0.12	1.36 0.13	1.47 0.14	1.57 0.15	1.68 0.16	1.79 0.17	1.90 0.18	2.00 0.19	2.11 0.20
	18 0.46	0.44 0.04	0.71 0.07	0.97 0.09	1.24 0.12	1.51 0.14	1.77 0.16	2.04 0.19	2.30 0.21	2.57 0.24	2.84 0.26	3.10 0.29	3.37 0.31	3.63 0.34	3.90 0.36	4.17 0.39	4.43 0.41	4.70 0.44	4.96 0.46	5.23 0.49
	24 0.61	0.68 0.06	1.09 0.10	1.50 0.14	1.92 0.18	2.33 0.22	2.74 0.25	3.15 0.29	3.56 0.33	3.97 0.37	4.38 0.41	4.79 0.44	5.20 0.48	5.61 0.52	6.02 0.56	6.43 0.60	6.84 0.64	7.25 0.67	7.66 0.71	8.07 0.75
	30 0.76	0.90 0.09	1.51 0.14	2.08 0.19	2.64 0.25	3.21 0.30	3.78 0.35	4.35 0.40	4.91 0.46	5.48 0.51	6.05 0.56	6.61 0.61	7.18 0.67	7.75 0.72	8.31 0.77	8.88 0.82	9.45 0.88	10.01 0.93	10.58 0.98	11.15 1.04
	36 0.91	1.21 0.11	1.93 0.18	2.65 0.25	3.38 0.31	4.10 0.38	4.82 0.45	5.55 0.52	6.27 0.58	6.99 0.65	7.72 0.72	8.44 0.78	9.16 0.85	9.89 0.92	10.61 0.99	11.33 1.05	12.06 1.12	12.78 1.19	13.50 1.25	14.23 1.32
	42 1.07	1.47 0.14	2.35 0.22	3.23 0.30	4.11 0.38	4.99 0.46	5.87 0.54	6.75 0.63	7.63 0.71	8.51 0.79	9.39 0.87	10.26 0.95	11.14 1.04	12.02 1.12	12.90 1.20	13.78 1.28	14.66 1.36	15.54 1.44	16.42 1.53	17.30 1.61
	48 1.22	1.73 0.16	2.76 0.26	3.80 0.35	4.84 0.45	5.87 0.55	6.91 0.64	7.93 0.74	8.98 0.83	10.02 0.93	11.06 1.03	12.09 1.12	13.13 1.22	14.17 1.32	15.20 1.41	16.24 1.51	17.28 1.60	18.31 1.70	19.35 1.80	20.39 1.89
	54 1.37	1.99 0.18	3.18 0.30	4.37 0.41	5.57 0.52	6.76 0.63	7.95 0.74	9.15 0.85	10.34 0.96	11.53 1.07	12.72 1.18	13.92 1.29	15.11 1.40	16.30 1.51	17.50 1.63	18.69 1.74	19.88 1.85	21.07 1.96	22.27 2.07	23.46 2.18
	60 1.52	2.25 0.21	3.60 0.33	4.95 0.46	6.30 0.59	7.65 0.71	9.00 0.84	10.35 0.96	11.70 1.09	13.05 1.21	14.40 1.34	15.75 1.46	17.10 1.59	18.45 1.71	19.80 1.84	21.15 1.96	22.50 2.09	23.85 2.22	25.20 2.34	26.55 2.47
	66 1.68	2.51 0.23	4.02 0.37	5.52 0.51	7.03 0.65	8.54 0.79	10.04 0.93	11.55 1.07	13.06 1.21	14.56 1.35	16.07 1.49	17.57 1.63	19.08 1.77	20.59 1.91	22.09 2.05	23.60 2.19	25.11 2.33	26.61 2.47	28.12 2.61	29.63 2.75
	72 1.83	2.77 0.26	4.43 0.41	6.10 0.57	7.76 0.72	9.42 0.88	11.09 1.03	12.75 1.18	14.41 1.34	16.08 1.49	17.74 1.65	19.40 1.80	21.07 1.96	22.73 2.11	24.39 2.27	26.05 2.42	27.72 2.57	29.38 2.73	31.04 2.88	32.71 3.04
	78 1.98	3.03 0.28	4.85 0.45	6.67 0.62	8.49 0.79	10.31 0.96	12.13 1.13	13.95 1.30	15.77 1.46	17.59 1.63	19.41 1.80	21.23 1.97	23.05 2.14	24.87 2.31	26.69 2.48	28.51 2.65	30.33 2.82	32.15 2.99	33.96 3.16	35.78 3.32
	84 2.13	3.29 0.31	5.27 0.49	7.25 0.67	9.22 1.04	11.20 1.22	13.18 1.41	15.15 1.59	17.13 1.77	19.10 1.96	21.08 2.14	23.06 2.33	25.03 2.51	27.01 2.69	28.99 2.88	30.96 3.06	32.94 3.24	34.92 3.43	36.89 3.61	38.87 3.79
	90 2.29	3.56 0.33	5.69 0.53	7.82 0.73	9.95 1.12	12.09 1.32	14.22 1.52	16.35 1.72	18.49 1.92	20.62 2.11	22.75 2.31	24.89 2.51	27.02 2.71	29.15 2.91	31.29 3.10	33.42 3.30	35.55 3.50	37.69 3.70	39.82 3.90	41.95 4.10
	96 2.44	3.82 0.35	6.11 0.57	8.39 0.78	10.68 0.99	12.97 1.21	15.26 1.42	17.55 1.63	19.84 1.84	22.13 2.06	24.42 2.27	26.71 2.48	29.00 2.69	31.29 2.91	33.58 3.12	35.87 3.33	38.16 3.54	40.45 3.76	42.74 3.97	45.03 4.18
	102 2.59	4.08 0.38	6.52 0.61	8.97 0.83	11.42 1.06	13.86 1.29	16.31 1.52	18.75 1.74	21.20 1.97	23.65 2.20	26.09 2.42	28.54 2.65	30.99 2.88	33.43 3.11	35.88 3.33	38.32 3.56	40.77 3.79	43.22 4.01	45.66 4.24	48.11 4.47
108 2.74	4.34 0.40	6.94 0.64	9.54 0.89	12.14 1.13	14.75 1.37	17.35 1.61	19.95 1.85	22.55 2.10	25.16 2.34	27.76 2.58	30.36 2.82	32.96 3.06	35.57 3.30	38.17 3.55	40.77 3.79	43.37 4.03	45.98 4.27	48.58 4.51	51.18 4.75	
114 2.90	4.70 0.44	7.53 0.70	10.35 0.96	13.17 1.22	15.99 1.49	18.81 1.75	21.63 2.01	24.46 2.27	27.28 2.53	30.10 2.80	32.92 3.06	35.74 3.32	38.57 3.58	41.39 3.84	44.21 4.11	47.03 4.37	49.85 4.63	52.68 4.89	55.50 5.16	
120 3.05	4.86 0.45	7.78 0.72	10.69 0.99	13.61 1.26	16.52 1.54	19.44 1.81	22.35 2.08	25.27 2.35	28.19 2.62	31.10 2.89	34.02 3.16	36.93 3.43	39.85 3.70	42.77 3.97	45.68 4.24	48.60 4.51	51.51 4.79	54.43 5.06	57.35 5.33	

**SCHEDULE TYPE:**

**PROJECT:**

**ENGINEER:**

**CONTRACTOR:**

Page 2 of 3  
Dimensions are in inches (mm).

**DATE**

**B SERIES**

**SUPERSEDES**

**DRAWING NO.**

2 - 19 - 24

1600

2 - 17 - 22

1606KD





**EXTRUDED ALUMINUM STATIONARY LOUVER  
6" (152) DEEP • K BLADE • DRAINABLE HEAD  
PERFORMANCE DATA  
MODEL: 1606KD**

**AIRFLOW/WATER PENETRATION DATA  
for 48" x 48" (1219 x 1219) Louver Size**

	Free Area %	50%
	Free Area sq. ft. (sq. m.)	7.93 (0.74)
I N T A K E	Free Area Velocity at Point of Beginning Water Penetration at .01 oz./sq. ft. (3 ml/sq. m) (15 min. test duration)	1017 fpm (310 m/min.)
	Air Volume at 1017 fpm	8065 cfm (3806 l/s)
	Free Area Velocity	
	Pressure Drop @ 1017 fpm	.14 in. w.g. (35 Pa)

**NOTE:** To minimize water penetration when sizing intake louvers, select a Free Area Velocity that is **below** the point of beginning water penetration.

**PRESSURE DROP**

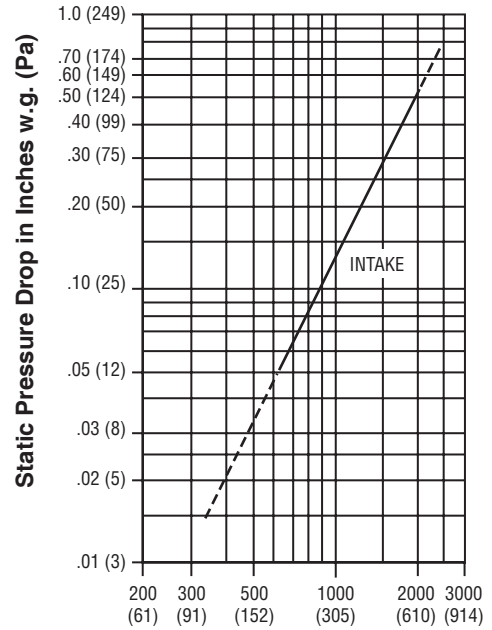

**Air Velocity in Feet (Meters) Per Minute Through Free Area**

Louver test size: 48" x 48" (1219 x 1219 mm).  
Standard air density @ 0.075 lbs/ft³.  
Tested to AMCA Fig. 5.5 – 6.5.

<b>SCHEDULE TYPE:</b>	Page 3 of 3			
<b>PROJECT:</b>	Dimensions are in inches (mm).			
<b>ENGINEER:</b>	<b>DATE</b>	<b>B SERIES</b>	<b>SUPERSEDES</b>	<b>DRAWING NO.</b>
<b>CONTRACTOR:</b>	2 - 19 - 24	1600	2 - 17 - 22	1606KD



**SPECIALTY STATIONARY LOUVERS  
EXTRUDED ALUMINUM  
CIRCULAR & SEMICIRCULAR SHAPES  
MODEL SERIES: 1600**

Nailor specialty shape louvers are available in a variety of blade/frame designs. The following louver models are available in specialty shapes as shown:

1602J	1604J	1604D	1606J	1606D
1602K	1604JD	1604DD	1606JD	1606DD
1602D	1604KD	1604Y	1606KD	1606DHP

**Note:** Use of drainable blades is not recommended on certain shapes. Consult Nailor for specific applications.

**PERFORMANCE:**

Standard louvers are tested for water penetration and pressure drop in a square configuration only. Performance of specialty shape louvers may vary from that of standard louvers.

Specialty shape louvers are not licensed to bear the AMCA seal.

**STANDARD CONSTRUCTION:**

**FRAME:** Type 6063-T6 extruded or formed aluminum. Channel type standard. Frame profile may vary depending upon louver style and shape. Contact Nailor for specific details.

**BLADES:** Type 6063-T6 extruded aluminum. See applicable louver model submittal sheet for blade profile.

**BLADE SUPPORT BRACKETS:** Concealed type, factory installed on rear of louver as necessary. Reinforced with 1 1/2" x 2" (38 x 51) vertical angle (adds approximately 2" [51] to overall louver depth).

**SCREEN:** 3/4" x .051 (19 x 1.3) expanded, flattened aluminum bird screen in removable frame, inside (rear) mount (adds approximately 3/8" [10] to louver depth).

**FINISH:** Mill.

**MINIMUM SIZE:** 20" (508) Diameter. Contact Nailor for smaller sizes.

**MAXIMUM SINGLE SECTION SIZE:** 120" W x 84" H (3048 x 2134) or 84" H x 120" W (2134 x 3048). Larger louvers will require field assembly of smaller sections. Consult Nailor for section details of specific sizes.

**OPTIONS:**

- FL** Flanged Frame.
- BSSS** Type 304 S.S. Bird Screen.
- BSN** No Bird Screen.
- ISA** Aluminum Insect Screen.
- ISSS** Type 304 S.S. Insect Screen.
- PAC** Perimeter Anchor Clips.
- Other:** \_\_\_\_\_.

**OPTIONAL FINISHES:**

- PC3** Powder Coat AAMA 2603. Color: \_\_\_\_\_.
- PC4** High Performance Powder Coat AAMA 2604 (Equivalent to 50% Kynar®). Color: \_\_\_\_\_.
- PC5** Fluoropolymer Powder Coat AAMA 2605 (Equivalent to 70% Kynar®). Color: \_\_\_\_\_.
- PCC** Prime Coat.
- AN04** Clear Anodized 204-R1.
- AN15** Clear Anodized 215-R1.

Color Anodized:

- ANLB** Light Bronze.
- ANDB** Dark Bronze.
- ANMB** Medium Bronze.
- ANBK** Black.

**OPTIONAL W x H SIZING** (1/4" [6.5] Undersize standard):

- U00** Exact Size.
- U38** Undersize 3/8" (9.5).
- U50** Undersize 1/2" (12.7).

Contact Nailor for special configurations or requirements.



**CA Circle (Round)**

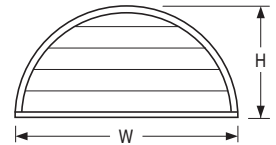

**CB Semi-Circle**

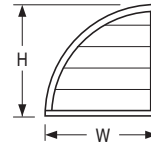

**CC 1/4 Circle Left**

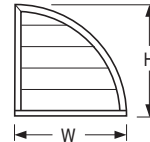

**CD 1/4 Circle Right**

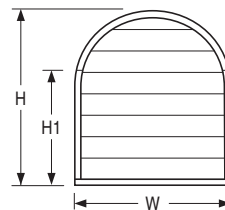

**CE Arch Semi-Circular**

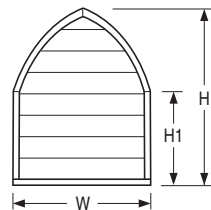

**CFC Arch Custom (Dropped or Lancet)**

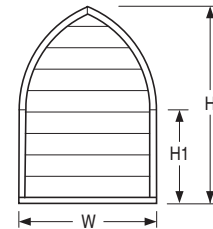

**CFE Arch Equilateral**

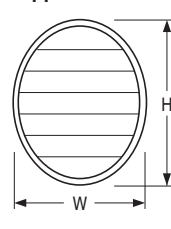

**CG Oval**

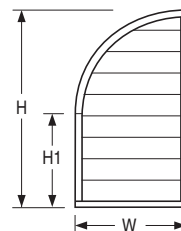

**CH Arch 1/4 Circle Left**

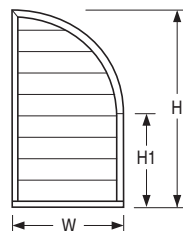

**CJ Arch 1/4 Circle Right**

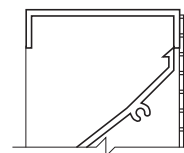

**TYPICAL CHANNEL FRAME (STANDARD)**

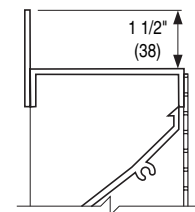

**OPTIONAL FLANGED FRAME (FL)**

Dimensions are in inches (mm)

**SCHEDULE TYPE:**

**PROJECT:**

**ENGINEER:**

**CONTRACTOR:**

DATE

B SERIES

SUPERSEDES

DRAWING NO.

2 - 17 - 22

1600

8 - 20 - 13R

1600CSC

**APPLICATION:**

Glazing adaptor for louver installation in common curtainwall and window systems. The 1" (25) deep adaptor is factory installed onto louver frame and is suitable for use on 2" (51), 4" (102) and 6" (152) deep extruded aluminum louver models.

**STANDARD CONSTRUCTION:**

**MATERIAL:** Type 6063-T6 extruded aluminum, .081" (2.06) nominal thickness.

**FINISH:** Mill.

**TYPICAL INSTALLATION:**

WINDOW/CURTAINWALL  
 SYSTEM AND GLAZING  
 GASKETS BY OTHERS

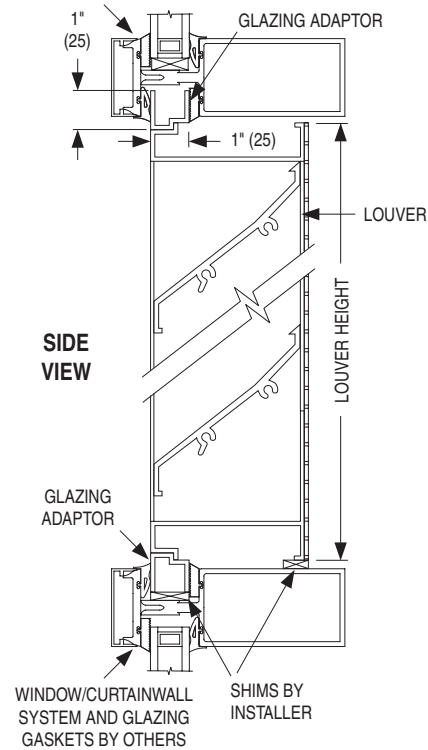
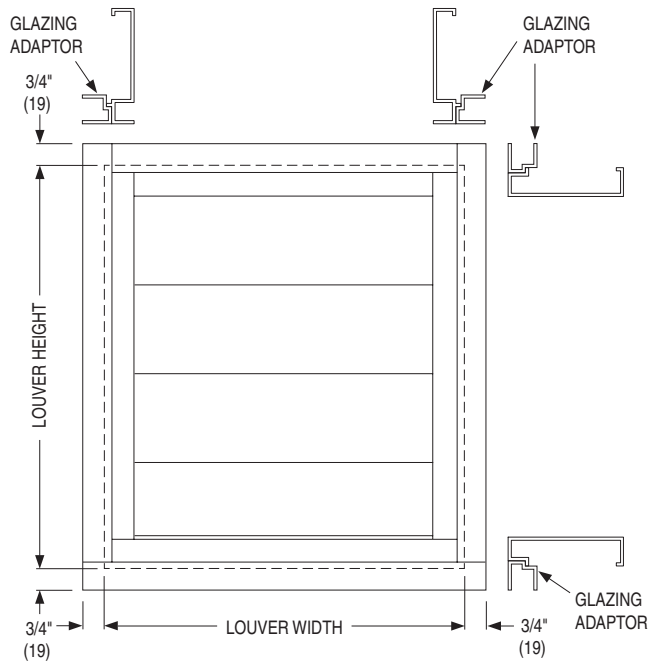
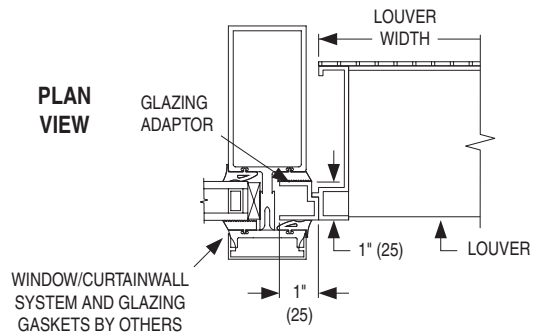
**PLAN VIEW**

**SCHEDULE TYPE:**

**PROJECT:**

**ENGINEER:**

**CONTRACTOR:**

Dimensions are in inches (mm)

**DATE**

**B SERIES**

**SUPERSEDES**

**DRAWING NO.**

2 - 17 - 22

1600

7 - 11 - 13

1600GA



**SPECIALTY STATIONARY LOUVERS**  
**EXTRUDED ALUMINUM**  
**TRIANGULAR & TRAPEZOIDAL SHAPES**  
**MODEL SERIES: 1600**

Nailor specialty shape louvers are available in a variety of blade/frame designs. The following louver models are available in specialty shapes as shown:

- |              |               |               |               |                |
|--------------|---------------|---------------|---------------|----------------|
| <b>1602J</b> | <b>1604J</b>  | <b>1604D</b>  | <b>1606J</b>  | <b>1606D</b>   |
| <b>1602K</b> | <b>1604JD</b> | <b>1604DD</b> | <b>1606JD</b> | <b>1606DD</b>  |
| <b>1602D</b> | <b>1604KD</b> | <b>1604Y</b>  | <b>1606KD</b> | <b>1606DHP</b> |

**Note:** Use of drainable blades is not recommended on certain shapes. Consult Nailor for specific applications.

**PERFORMANCE:**

Standard louvers are tested for water penetration and pressure drop in a square configuration only. Performance of specialty shape louvers may vary from that of standard louvers.

Specialty shape louvers are not licensed to bear the AMCA seal.

**STANDARD CONSTRUCTION:**

**FRAME:** Type 6063-T6 extruded or formed aluminum. Channel type standard. Frame profile may vary depending upon louver style and shape. Contact Nailor for specific details.

**BLADES:** Type 6063-T6 extruded aluminum. See applicable louver model submittal sheet for blade profile.

**BLADE SUPPORT BRACKETS:** Concealed type, factory installed on rear of louver as necessary. Reinforced with 1 1/2" x 2" (38 x 51) vertical angle (adds approximately 2" [51] to overall louver depth).

**SCREEN:** 3/4" x .051 (19 x 1.3) expanded, flattened aluminum bird screen in removable frame, inside (rear) mount (adds approximately 3/8" [10] to louver depth).

**FINISH:** Mill.

**MINIMUM SIZE:** 20" W x 16" H (508 x 406).

**MAXIMUM SINGLE SECTION SIZE:** 120" W x 84" H (3048 x 2134) or 84" W x 120" H (2134 x 3048).

**SECTION SIZE:** Consult Nailor for section details of specific sizes. Larger louvers will require field assembly of smaller sections.

**OPTIONS:**

- |   |   |
|---|---|
| <input type="checkbox"/> <b>FL</b> Flanged Frame.               | <input type="checkbox"/> <b>ISSS</b> Type 304 S.S. Insect Screen. |
| <input type="checkbox"/> <b>BSSS</b> Type 304 S.S. Bird Screen. | <input type="checkbox"/> <b>PAC</b> Perimeter Anchor Clips.       |
| <input type="checkbox"/> <b>BSN</b> No Bird Screen.             | <input type="checkbox"/> <b>Other:</b> _____                      |
| <input type="checkbox"/> <b>ISA</b> Aluminum Insect Screen.     |   |

**OPTIONAL FINISHES:**

- |  |
|--|
| <input type="checkbox"/> <b>PC3</b> Powder Coat AAMA 2603. Color: _____.   |
| <input type="checkbox"/> <b>PC4</b> High Performance Powder Coat AAMA 2604 (Equivalent to 50% Kynar®). Color: _____. |
| <input type="checkbox"/> <b>PC5</b> Fluoropolymer Powder Coat AAMA 2605 (Equivalent to 70% Kynar®). Color: _____.    |

- |   |
|---|
| <input type="checkbox"/> <b>PCC</b> Prime Coat.             |
| <input type="checkbox"/> <b>AN04</b> Clear Anodized 204-R1. |
| <input type="checkbox"/> <b>AN15</b> Clear Anodized 215-R1. |

Color Anodized:

- |  |   |
|--|---|
| <input type="checkbox"/> <b>ANLB</b> Light Bronze. | <input type="checkbox"/> <b>ANMB</b> Medium Bronze. |
| <input type="checkbox"/> <b>ANDB</b> Dark Bronze.  | <input type="checkbox"/> <b>ANBK</b> Black.         |

**OPTIONAL W x H SIZING** (1/4" [6.5] Undersize standard):

- |  |
|--|
| <input type="checkbox"/> <b>U00</b> Exact Size.            |
| <input type="checkbox"/> <b>U38</b> Undersize 3/8" (9.5).  |
| <input type="checkbox"/> <b>U50</b> Undersize 1/2" (12.7). |

Contact Nailor for special configurations or requirements.

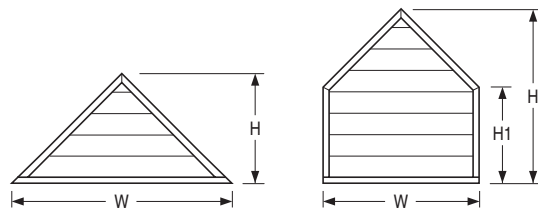

**TA Triangle Isosceles**

**TB Arch Gable**

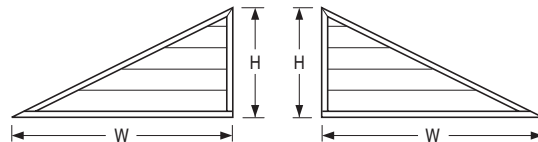

**TC Triangle RA Left**

**TD Triangle RA Right**

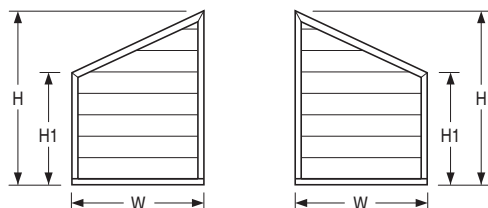

**TE Quadrilateral Left**

**TF Quadrilateral Right**

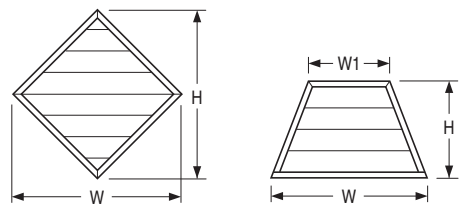

**TG Diamond/Rhombus**

**TH Trapezoid**

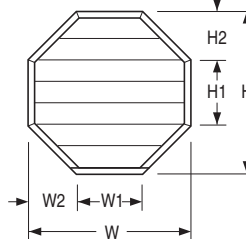

**TJ Octagon**

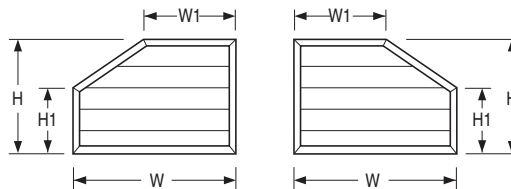

**TK Left Corner**

**TL Right Corner**

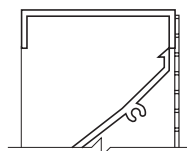

TYPICAL CHANNEL FRAME (STANDARD)

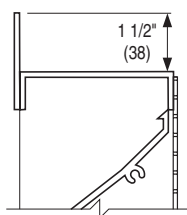

OPTIONAL FLANGED FRAME (FL)

Dimensions are in inches (mm)

<b>SCHEDULE TYPE:</b>				
<b>PROJECT:</b>				
<b>ENGINEER:</b>	<b>DATE</b>	<b>B SERIES</b>	<b>SUPERSEDES</b>	<b>DRAWING NO.</b>
<b>CONTRACTOR:</b>	2 - 17 - 22	1600	8 - 20 - 13	1600TT



 Slate Blue **LF01**

 Medium Bronze **LF02**

 Sandstone **LF03**

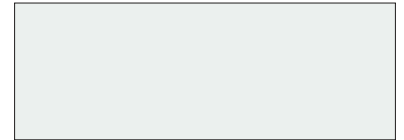
 Light Gray **LF04**

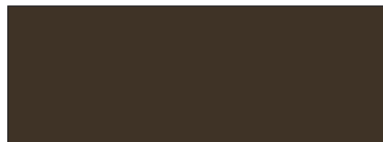
 Charcoal **LF05**

 Bone White **LF06**

 Western Tan **LF07**

 Architectural Bronze **LF08**

 Regal Blue **LF09**

 Forest Green **LF10**

 Surrey Beige **LF11**

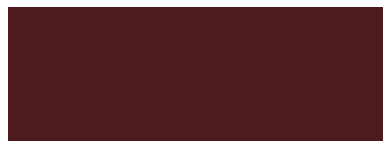
 Royal Brown **LF12**

 Barn Red **LF13**

 Burgundy **LF14**

 Clay **LF15**

 Almond **LF16**

 Coastal White **LF17**

 Vista Green **LF18**

 Black **LF19**

 Gloss Black **LF20**

 Campus Green **LF21**

Nailor offers 21 standard paint colors selected for architectural exterior use which meet or exceed AAMA specifications and performance requirements for color retention, chalk resistance, gloss retention, erosion, corrosion and chemical resistance as well as dry film thickness and hardness. Our state-of-the-art powder coat system provides an environment friendly finishing solution with more uniform coverage and coating thickness. The result is an exceptional finish that better resists scratching, fading and general wear. Additional liquid coat facilities for special requirements complete our ability to provide unmatched beauty and durability for any application.

Custom color matching is also available upon request. Contact your local Nailor representative.

# Available Finishes

FINISH TYPE	DESCRIPTION	STANDARD WARRANTY
<b>Fluoropolymer Powder Coat</b> AAMA 2605-Superior Finish (AKA: Powdura® 5000, Corafalon® Powder, Interpon® D3000-Fluoromax, IFS 500FP)	<b>"Ultimate"</b> - A next generation hyper durable powder coating, based on FEVE fluoropolymer resins and ceramic pigmentation that the industry has acknowledged as the foundation for superior performance coatings. They provide a hard surface that is resistant to scratching and scuffing, with superior color and gloss retention, when applied to a variety of exterior architectural applications. This technology represents the "ultimate" in environmentally friendly finishes, with Zero-VOC emissions.  A superior alternative to traditional 70% Kynar 500® / Hylar 500® PVDF fluoropolymer liquid coatings.	10 years (Consult Nailor for availability of extended warranty)
<b>High Performance Powder Coat</b> AAMA 2604 - High Performance Finish (AKA: Powdura® 4000, Envirocron® Ultra Durable Powder, Dynadure™ 400, Interpon® D2000, IFS 400SD)	<b>"Better"</b> - A high performance polyester powder coating, based on "super durable" resins that utilize infrared reflective pigments, which provides excellent resistance to outdoor weathering. A harder and more environmentally friendly coating than other liquid paint counterparts and with Zero-VOC emissions.  A good alternative to 50% Kynar 500® / Hylar 5000® liquid coatings.	5 years
<b>Durable Powder Coat</b> AAMA 2603 - Pigmented Organic Coatings (AKA: Powdura® 3000, Envirocron® Durable Powder, Dynadure™ 300, Interpon® D1000, IFS 300SP)	<b>"Good"</b> - A durable powder coat based on thermosetting polyester resin technology.  Provides a good economical combination of physical and chemical resistance properties. Environmentally superior to liquid spray paints and Zero – VOC emissions.	1 year
<b>Clear Anodize 215-R1</b> AA-M10C22A41 (0.7 mil. min.)	Architectural Class I. Clear, colorless and hard oxide aluminum coating that resists weathering and chemical attack. Recommended for severely corrosive and abrasive atmospheric exposure.	5 years
<b>Clear Anodize 204-R1</b> AA-M10C22A31 (0.4 - 0.7 mil.)	Architectural Class II. Clear, colorless and hard oxide aluminum coating that resists weathering and chemical attack. Recommended for normal weather exposure.	1 year
<b>Color Anodize</b> AA-M10C22A44 (0.7 mil. min.)	Architectural Class I. "Two-step" aluminum coating process. Following a standard anodizing procedure, a second electrolytic process deposits colored metallic pigments which penetrate the aluminum oxide pores, producing a corrosion resistant, colorfast finish. Available in light, medium, dark bronze and black.	5 years
<b>Prime Coat</b>	Prime coat provides a stable base for painting of louvers in the field. Surface pretreatment includes degreasing and a chemical cleaning before an epoxy prime coat is applied. Finish coat should be field applied as soon as possible for best adhesion, after a thorough cleaning for dust etc. that can contaminate the final finish and cause premature flaking or peeling.	N/A

*Paint finish warranties are not applicable to steel products.*

*Powdura® is a registered trademark of The Sherwin-Williams Company.*

*Corafalon® and Envirocron® are registered trademarks of PPG Industries Ohio, Inc.*

*Interpon® is a registered trademark of Akzo Nobel Powder Coatings Ltd.*

*Kynar 500® is a registered trademark of Arkema, Inc.*

*Hylar 5000® is a registered trademark of Solvay Solexis, Inc.*